

OWNER'S MANUAL

PRO-70 50-Channel Portable Scanner

Please read before using this equipment.



RadioShack[®]

Cat. No. 20-310

INTRODUCTION

Your new RadioShack PRO-70 50-Channel Portable Scanner lets you in on all the action. This scanner gives you direct access to over 22,000 exciting frequencies, including police and fire departments, ambulance services, and amateur radio services. You can select up to 50 channels to scan, and you can change your selection at any time.

The secret to your scanner's ability to scan so many frequencies is its custom-designed microprocessor — a tiny, built-in computer. Your scanner also has these special features:

Ten Preprogrammed Search Bands — let you search for transmissions within preset frequency ranges, so you can find interesting frequencies more quickly.

Ten Preprogrammed Weather Frequencies — keep you informed about current weather conditions.

Two-Second Automatic Scan Delay — delays scanning for 2 seconds before moving to another channel, so you can hear more replies.

50 Channels — let you store up to 50 of your favorite frequencies for easy recall and scanning.

Monitor Memory — lets you temporarily save an active frequency you locate during a direct search, until you decide whether or not you want to save it into a channel.

Memory Backup — keeps the channel frequencies stored in memory for about 1 hour during a power loss.

© 1997 Tandy Corporation.
All Rights Reserved.

RadioShack is a registered trademark used by Tandy Corporation.
U.S. Patent No's. 3,794,925: 3,801,914: 3,961,261: 3,962,644:
4,027,251: 4,092,594: 4,123,715: 4,245,348.

Channel Lockout — keeps channels you select from being scanned.

Key Lock — lets you lock the scanner's keys to help prevent accidentally changing the scanner's programming.

Flexible Antenna with BNC Connector — provides excellent reception and is designed to help prevent antenna breakage.

Liquid Crystal Display — makes it easy to view and change programming information.

Display Backlight — makes the scanner easy to read in low light situations.

Three Power Options — let you power the scanner from internal batteries (non-rechargeable batteries or a rechargeable scanner battery pack) or external AC or DC power (using optional adapters).

We recommend you record your scanner's serial number here. This number is on the scanner's back panel.

Serial Number: _____

Your PRO-70 scanner contains the following preprogrammed frequencies (divided into search bands). See "Using Band Search" on Page 25.

Band	Frequency Search Range (in MHz)	Description
0	29-30	10-Meter Amateur Radio
1	30-50	VHF Low
2	50-54	6-Meter Amateur Radio
3	137-144	Aircraft/Air Shows, Government
4	144-148	2-Meter Amateur Radio
5	148-174	VHF Hi
6	380-420	U.S. Government
7	420-450	70-Centimeter Amateur Radio
8	450-470	UHF Low
9	470-512	UHF "T" Band

In addition, your scanner is preprogrammed with the following weather service frequencies:

161.650	161.775	162.400	162.425
162.525	162.450	162.475	
162.500	162.550	163.275	

This owner's manual also includes the section "A General Guide to Scanning," which helps you target frequency ranges in your service area so you can search for a wide variety of broadcasts.

FCC NOTICE

Your scanner might cause TV or radio interference even when it is operating properly. To determine whether your scanner is causing the interference, turn off your scanner. If the interference goes away, your scanner is causing the interference. Try the following methods to eliminate the interference.

- Move your scanner away from the TV or radio
- Connect your scanner to an outlet that is on a different electrical circuit from the TV or radio
- Contact your local RadioShack store for help

If you cannot eliminate the interference, the FCC requires that you stop using your scanner.

This device complies with Part 15 of the *FCC Rules*. Operation is subject to the following conditions: (1) This device must not cause harmful interference, and (2) This device must accept any interference received, including interference that may cause undesired operation.

Note: Mobile use of this scanner is unlawful or requires a permit in some areas. Check the laws in your area.

SCANNING LEGALLY

Scanning is a fun and interesting hobby. You can hear police and fire departments, ambulance services, government agencies, private companies, amateur radio services, aircraft, and military operations. It is legal to listen to almost every transmission your scanner can receive. However, there are some electronic and wire communications that are illegal to intentionally intercept. These include:

- Telephone conversations (cellular, cordless, or other private means of telephone signal transmission)
- Pager transmissions
- Scrambled or encrypted transmissions

According to the *Federal Electronic Communications Privacy Act* (ECPA), as amended, you could be fined and possibly imprisoned for intentionally listening to, using, or disclosing the contents of such a transmission unless you have the consent of a party to the communication (unless such activity is otherwise illegal). These laws change from time to time and there might be state or local laws that also affect legal scanner usage.

CONTENTS

Preparation	9
Power Sources	9
Using Batteries	9
Using Standard AC Power	11
Using Vehicle Battery Power	12
Charging a Rechargeable Battery Pack	13
Connecting the Antenna	14
Connecting an Optional Antenna	15
Connecting an Earphone/Headphones	16
Listening Safely	16
Traffic Safety	16
Connecting an Extension Speaker	17
Using the Belt Clip	17
Understanding the PRO-70	18
A Look at the Keypad	18
A Look at the Display	19
Operation	21
Turning On the Scanner and Setting SQUELCH ..	21
Searching For and Storing Active Frequencies ...	22
Active Frequency References	22
Storing Frequencies	23
Using Band Search	25
Using Direct Search	27
Using the Monitor Memory	28
Listening to the Monitor Memory	28
Moving a Frequency from the Monitor Memory to a Channel	28
Scanning the Stored Channels	29
Monitoring a Stored Channel	30
Clearing a Stored Channel	31
Special Features	32
Using the Keylock	32
Locking Out Channels	32
Using a 2-Second Delay	33
Using the Display Backlight	34
Listening to a Weather Band	34

A General Scanning Guide	36
Guide to Frequencies	36
National Weather Frequencies	36
Ham Radio Frequencies	36
Birdie Frequencies	37
Guide to the Action Bands	37
United States Broadcast Bands	37
Typical Band Usage	38
Primary Usage	38
Specified Intervals	39
Band Allocation	40
Avoiding Image Frequencies	45
Frequency Conversion	46
Troubleshooting	47
Resetting/Initializing the Scanner	49
Resetting the Scanner	49
Initializing the Scanner	50
Care and Maintenance	51
Specifications	52

PREPARATION

POWER SOURCES

You can power your scanner from any of three sources:

- Internal batteries or a rechargeable scanner battery pack (not supplied — see “Using Batteries”)
- Standard AC power (with an optional AC adapter — see “Using Standard AC Power” on Page 11)
- Vehicle battery power (with an optional DC adapter — see “Using Vehicle Battery Power” on Page 12)

Notes:

- Connecting an AC or DC adapter to the scanner disconnects any internal batteries, but it does not disconnect a rechargeable battery pack. If you install a rechargeable battery pack, you can operate the scanner and recharge the battery pack at the same time. See “Using Batteries” and “Charging a Rechargeable Battery Pack” on Page 13.
- If the scanner stops working properly after connecting it to power, try resetting it. See “Resetting/Initializing the Scanner” on Page 49.

Using Batteries

You can power your scanner from six AA batteries. For the longest operation and best performance, we recommend alkaline batteries, such as RadioShack Cat. No. 23-552. You can also power the scanner from a rechargeable scanner battery pack, such as Cat. No. 23-288.

Note: You can also use six rechargeable nickel-cadmium batteries (such as Cat. No. 23-125) to power the scanner. To charge or recharge nickel-cadmium batteries, however, you must remove them from the scanner and use an external charger (such as Cat. No. 23-134).

Follow these steps to install batteries or a battery pack.

1. Press down on the battery compartment cover on the bottom of the scanner and slide the cover in the direction of the arrow to remove it.

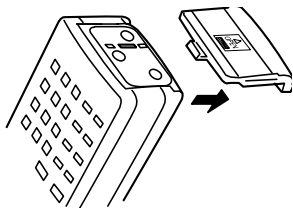

2. Pull up and slide the battery holder or battery pack out of the battery compartment.

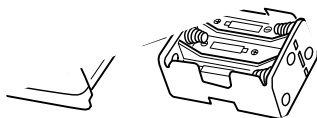

3. If you are installing individual batteries, insert six batteries in the battery holder as indicated by the polarity symbols (+ and -) marked on the battery holder.

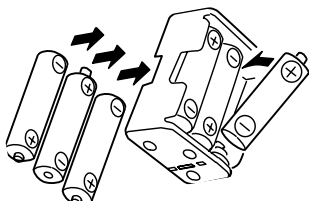

-
-
- Slide the battery holder or battery pack into the compartment.

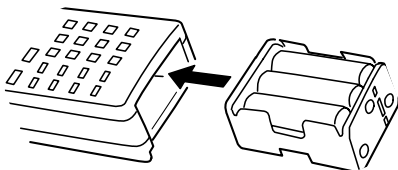

Caution: The battery holder or battery pack fits only one way inside the battery compartment. Do not force it.

- Replace the cover.

If **BATT** flashes on the display, immediately replace all six non-rechargeable batteries, remove and recharge all six rechargeable batteries, or recharge the battery pack. See “Charging a Rechargeable Battery Pack” on Page 13.

Caution: Always dispose of old batteries promptly and properly. Do not bury or burn them.

Using Standard AC Power

To power the scanner from AC power, you need an AC adapter such as RadioShack Cat. No. 273-1665. Plug the adapter's barrel plug into the scanner's **PWR/DC 9V** jack. Then plug the adapter's power module into a standard AC outlet.

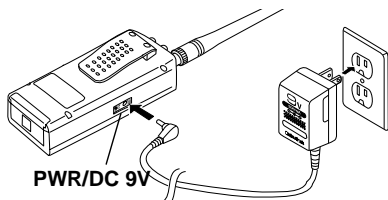

Warning: Do not use an AC adapter's polarized plug with an extension cord, receptacle, or other outlet unless the blades can be fully inserted to prevent blade exposure.

Cautions:

- You must use an AC adapter that supplies 9 volts and delivers at least 300 milliamps. Its center tip must be set to negative, and its plug must correctly fit the scanner's **PWR/DC 9V** jack. The recommended adapter meets these specifications. Using an adapter that does not meet these specifications could damage the scanner or the adapter.
- When you finish using the AC adapter, disconnect it from the AC outlet first. Then disconnect it from the scanner.

Using Vehicle Battery Power

To power the scanner from your vehicle's cigarette lighter socket, you need a DC Adapter, such as Cat. No. 270-1560.

Cautions:

- You must use a DC adapter that supplies (regulated) 9-volt power and delivers at least 300 milliamps. Its center tip must be set to negative, and its plug must correctly fit the scanner's **PWR/DC 9V** jack. The recommended adapter meets these specifications. Using an adapter that does not meet these specifications could damage the scanner or the adapter.
- To protect your vehicle's electrical system, always plug the adapter into the scanner before you plug it into your vehicle's cigarette-lighter socket. Always unplug the adapter from the vehicle's cigarette-lighter socket before you unplug it from the scanner.

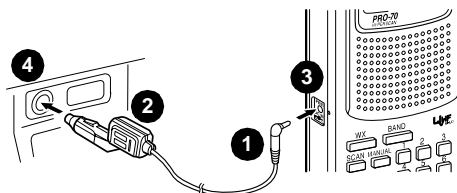

1. Connect the DC adapter's orange barrel plug to the adapter's cable, with the tip set to – (negative).
2. Set the adapter's voltage switch to 9V.
3. Insert the barrel plug into the scanner's **PWR/DC 9V** jack.
4. Plug the other end of the adapter into your vehicle's cigarette-lighter socket.

Note: If the scanner does not operate properly when you connect a DC adapter, unplug the adapter from the cigarette-lighter socket and clean the socket to remove ashes and other debris.

Charging a Rechargeable Battery Pack

Your scanner has a built-in charging circuit that lets you charge a rechargeable scanner battery pack (Cat. No. 23-288, not supplied) while it is in the scanner. To charge a battery pack, simply connect an appropriate AC or DC adapter to the **PWR/DC 9V** jack.

Note: If you want to take the battery pack out of the scanner to charge it, follow the instructions provided with the battery pack.

It takes about 14-16 hours to recharge a battery pack that is fully discharged. You can operate the scanner while recharging the battery pack, but the charging time is lengthened.

Note: A rechargeable battery pack lasts longer and delivers more power if you occasionally let it fully discharge. To do this, simply use the scanner until **BATT** appears on the display. Then fully charge the battery pack.

Important! At the end of a rechargeable battery pack's useful life, it must be recycled or disposed of properly. Contact your local, county, or state hazardous waste management authorities for information on recycling or disposal programs in your area. Some options that might be available are: municipal curb-side collection, drop-off boxes at retailers, recycling collection centers, and mail-back programs.

CONNECTING THE ANTENNA

Follow these steps to attach the supplied flexible antenna to the **ANT** jack on the top of your scanner.

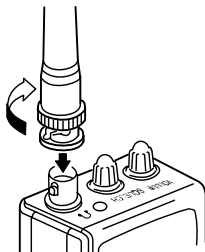

1. Align the slots around the antenna's connector with the tabs on the **ANT** jack.
2. Press the antenna down over the jack and turn the antenna's base clockwise until it locks into place.

Connecting an Optional Antenna

The antenna connector on your scanner makes it easy to use the scanner with a variety of antennas. Instead of the supplied antenna, you can attach a different one, such as an external mobile antenna or outdoor base station antenna. Your local RadioShack store sells a variety of antennas.

Always use 50-ohm coaxial cable, such as RG-58 or RG-8, to connect an outdoor antenna. For lengths over 50 feet, use RG-8 low-loss dielectric coaxial cable. If your antenna's cable does not have a BNC connector, you will also need a BNC adapter (also available at your local RadioShack store).

Follow the installation instructions supplied with the antenna, route the antenna cable to the scanner, then connect it to the **ANT** jack.

Warning: Use extreme caution when installing or removing an outdoor antenna. If the antenna starts to fall, let it go! It could contact overhead power lines. If the antenna touches a power line, contact with the antenna, mast, cable or guy wires can cause electrocution and death! Call the power company to remove the antenna. Do not attempt to do so yourself.

CONNECTING AN EARPHONE/ HEADPHONES

For private listening, you can plug an earphone or mono headphones (such as Cat. No. 33-175 or 20-210) into the  jack on top of your scanner. This automatically disconnects the internal speaker.



Listening Safely

To protect your hearing, follow these guidelines when you use an earphone or headphones:

- Do not listen at extremely high volume levels. Extended high-volume listening can lead to permanent hearing loss.
- Set the volume to the lowest setting before you begin listening. After you begin listening, adjust the volume to a comfortable level.
- Once you set the volume, do not increase it. Over time, your ears adapt to the volume level, so a volume level that does not cause discomfort might still damage your hearing.

Traffic Safety

Do not wear an earphone or headphones while you drive a vehicle or ride a bicycle. This can create a traffic hazard and can be illegal in some areas.

Even though some earphones and headphones let you hear some outside sounds when you listen at normal levels, they still can present a traffic hazard.

CONNECTING AN EXTENSION SPEAKER

In a noisy area, an extension speaker (such as Cat. No. 21-549) or an amplified speaker (such as Cat. No. 21-541), positioned in the right place, might provide more comfortable listening. Plug the speaker cable's $\frac{1}{8}$ -inch mini-plug into your scanner's  jack.

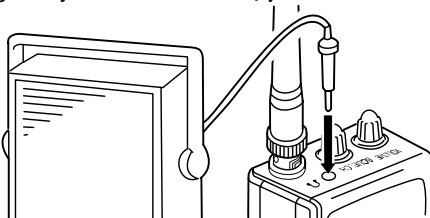

USING THE BELT CLIP

You can use the belt clip attached to the back of the scanner for hands-free carrying when you are on the go. Simply slide the belt clip over your belt or waistband.

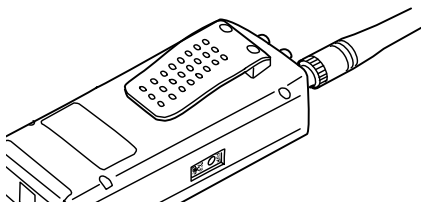

UNDERSTANDING THE PRO-70

A LOOK AT THE KEYPAD

Your scanner's keys might seem confusing at first, but this information should help you understand each key's function.

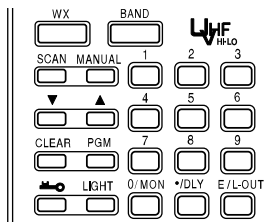

WX — scans through the 10 preprogrammed weather channels.

BAND — selects a preprogrammed search band.

SCAN — scans through the programmed channels.

MANUAL — stops scanning and lets you directly enter a channel number.

▲/▼ — begins searching up or down for active frequencies, or selects the direction when you scan channels.

CLEAR — clears an incorrect entry.

PGM — programs frequencies into channels.

🔑 — locks/unlocks the keypad to prevent accidental entries.

LIGHT — turns on/off the display's backlight.

Number Keys (1-9) — enter a channel/frequency number.

0/MON — enters a zero or accesses the monitor memory.

./DLY — enters a decimal point (necessary when programming frequencies), or programs a 2-second delay for the selected channel.

E/L-OUT — (enter/lockout) enters frequencies into channels, or locks out channels so they will not be scanned.

A LOOK AT THE DISPLAY

The display has indicators that show the scanner's current operation. A quick look at the display will help you understand how to operate your scanner.

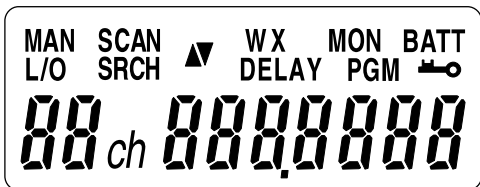

MAN — appears when you manually select a channel.

SCAN — appears when you scan channels.

WX — appears when you scan or manually search the 10 preprogrammed weather channels.

MON — appears when you listen to the monitor memory.

BATT — appears when the batteries are low.

L/O — appears when you manually select a channel you locked-out while scanning.

SRCH — appears during band and direct frequency searches.

▲/▼ — indicate the search or scan direction.

DELAY — appears when you program a 2-second delay for a channel.

PGM — appears while you program frequencies into the scanner's channels.

⏏ — appears when you lock the keypad.

ch — the digits that precede this indicator (1—50) show which channel the scanner is tuned to.

-d — appears during a direct frequency search.

000.0000 — the digits in the middle of the display show which frequency the scanner is tuned to.

Error — appears when you make an entry error.

dUPL — (duplicate) appears when you try to store a frequency that is already stored in another channel.

OPERATION

TURNING ON THE SCANNER AND SETTING SQUELCH

1. Turn **SQUELCH** fully counterclockwise before you turn on the scanner.

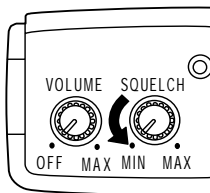

2. Turn **VOLUME** clockwise until you hear a hissing sound.

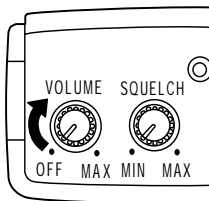

3. Turn **SQUELCH** clockwise, just until the hissing sound stops.

Note: To listen to a weak or distant station, turn **SQUELCH** counterclockwise. If reception is poor, turn **SQUELCH** clockwise to cut out weak transmissions.

SEARCHING FOR AND STORING ACTIVE FREQUENCIES

Your scanner can store up to 51 frequencies. Each frequency can be stored in either a memory called a channel, or the temporary memory called a monitor. This scanner has 50 channels and one monitor memory.

You can store frequencies using any of these methods.

- Manually enter and store a specific frequency (see “Storing Frequencies” on Page 23).
- Search for active frequencies within a range of pre-programmed frequencies and store selected frequencies in the scanner’s channel memories (see “Using Band Search” on Page 25).
- Search for active frequencies starting directly from one specific frequency and store a frequency in the scanner’s monitor memory (see “Using Direct Search” on Page 27).
- Recall the monitor memory frequency and move that frequency to a channel memory (see “Using the Monitor Memory” on Page 28).

Active Frequency References

Good references for active frequencies are RadioShack’s *Beyond Police Call, Police Call Radio Guide Including Fire and Emergency Services, Aeronautical Frequency Directory*, and *Radio!* magazine. We update these references often, so be sure to get a current copy.

If you do not have a reference to frequencies in your area, or if you want to search for unlisted frequencies, use a band search or direct search. See also “Guide to the Action Bands” on Page 37 in this manual.

Storing Frequencies

Follow these steps to store frequencies into your scanner's channels.

1. Press **PGM**. **PGM** appears on the display to indicate the scanner is in the programming mode.

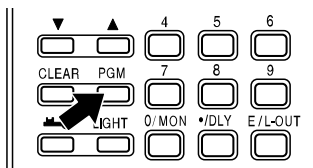

2. Use the number keys to enter the channel number (1-50) where you want to store the frequency, then press **PGM** again. Or, repeatedly press **PGM** until the desired channel number appears.

Notes:

- If you enter an invalid channel number, **Error** appears on the display. Simply repeat this step.
 - If a frequency is currently stored in the selected channel, the channel number does not flash but the current frequency number appears on the display. You can either repeat this step to select a different channel, or replace the current frequency with a new one.
3. Use the number keys and **/DLY** to enter the frequency (including the decimal point) you want to store in that channel.

-
-
4. Press **E/L-OUT** to store the frequency. The selected channel number stops flashing, indicating that the selected channel is stored.

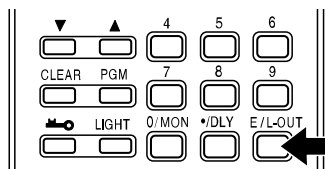

Notes:

- If you entered an invalid frequency in Step 3, **Error** appears on the display after you press **E/L-OUT**. Simply repeat Steps 3 and 4 and enter a valid frequency in Step 3.
- Your scanner automatically rounds the entered frequency down to the nearest valid frequency. For example, if you try to enter a frequency of 151.4730, your scanner accepts it as 151.4700.
- If you entered a frequency that is already stored in another channel, **DUPL** (duplicate) and the lowest-numbered channel containing the duplicate frequency flash on the display for about 3 seconds.

To store the duplicate frequency, press **E/L-OUT** again. To store a different frequency, repeat Steps 3 and 4, and enter a different frequency in Step 3.

5. Repeat Steps 2-4 to program another channel.

Using Band Search

If you do not know of a frequency to store, you can search your scanner's preprogrammed search bands for active frequencies, then store any that you find into your scanner's channels.

Follow these steps to search for and store active frequencies using band search.

1. Press **BAND**. The last selected band number (**b** followed by a number, such as **b2**) and the associated frequency search range appear on the display.

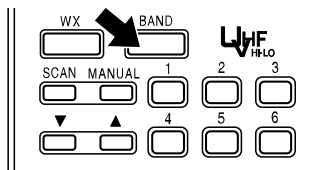

2. To select a different band, within 2 seconds, enter the desired band number (**0-9**, see Page 4 for descriptions) or repeatedly press **BAND** until the desired band number appears on the display. After about 2 seconds, **SRCH ▲** appears, the next available channel flashes, and the scanner begins searching rapidly upward in that band (from lowest to highest frequency) for an active frequency.

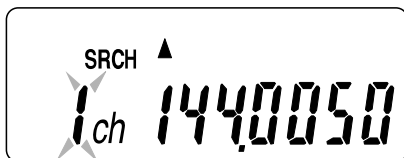

Notes:

- To select a different band after the scanner begins searching the current band, simply repeat this step.

- To reverse the rapid search direction at any time, press and hold ▼ or ▲ for about 1 second.
 - To search the selected band upward or downward in small increments (in steps of 5 or 12.5 kHz, depending on the band), press and release ▲ or ▼ so ▲ or ▼ disappears from the display. See “Specified Intervals” on Page 39.
3. When the scanner finds an active frequency, it stops scanning and displays that frequency’s number. To store that frequency in the channel currently flashing on the display, simply press **E/L-OUT**. The scanner stores the frequency, then the next available channel flashes on the display.

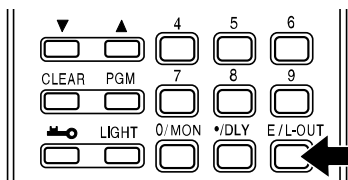

Notes:

- You cannot store an active frequency in the monitor memory during band search.
 - After you store a frequency into the last available channel, **--ch** appears instead of a channel number. If you try to store a channel while **--ch** appears, **Ch FULL** appears briefly on the display. In order to store more frequencies, you must clear some channels. See “Clearing a Stored Channel” on Page 31.
4. To search for another active frequency in the selected band, press and hold ▲ or ▼ for about 1 second, then repeat Step 3.

To select a different band then search for another active frequency, repeat Steps 2 and 3.

Using Direct Search

During a direct search, the scanner searches upward or downward, starting from a frequency you specify. Follow these steps to use direct search.

1. Press **MANUAL** or **PGM**, then enter the frequency you want to use as a starting point for the search.

Note: To start from a frequency already stored in one of your scanner's channels, press **MANUAL** or **PGM**, enter the desired channel number, then press **MANUAL** or **PGM** again.

2. Press and hold ▲ or ▼ for about 1 second to search upward or downward. **-d**, **SRCH**, and ▲ or ▼ appear on the display.

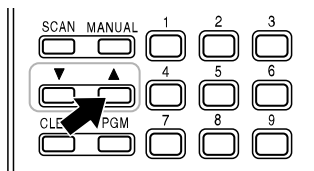

3. When the scanner stops on an active frequency, you can either:
 - Press **0/MON** to store it in the monitor memory.
 - Press and hold ▲ or ▼ to continue the search.

USING THE MONITOR MEMORY

After you store a frequency in the scanner's monitor memory during a direct search, you can recall it and move it to one of your scanner's channel memories.

Listening to the Monitor Memory

To recall a frequency stored in the monitor memory, simply press **MANUAL** then **0/MON. MAN** then **MON** and the stored frequency appear on the display.

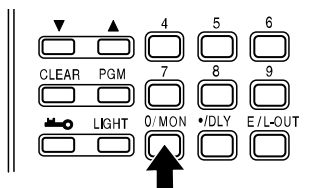

Moving a Frequency from the Monitor Memory to a Channel

1. Press **MANUAL**, enter the channel number where you want to store the frequency, then press **PGM. PGM** and the selected channel number appear on the display.
2. Press **MON. MON** and the monitor memory frequency appear on the display.
3. Press **E/L-OUT. MON** disappears, the channel number stops flashing, and the frequency is stored in the selected channel.

SCANNING THE STORED CHANNELS

To set the scanner to continuously scan through all channels with stored frequencies, simply press **SCAN**. **SCAN** and ▲ appear on the display, and the scanner begins to rapidly scan upward until it finds an active frequency.

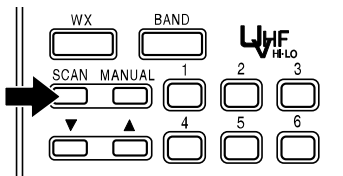

If the scanner finds an active frequency, it stops and displays that channel and frequency number, then it automatically begins scanning again when the transmission ends on that frequency.

Notes:

- To reverse the scanning direction, press ▲ or ▼.
- To set the scanner to remain on the current channel for 2 seconds after the transmission ends, see “Using a 2-Second Delay” on Page 33.
- To set the scanner to remain on the current channel, even after the transmission stops, press **MANUAL** at any time during the transmission so **MAN** appears and **SCAN** disappears from the display (see “Monitoring a Stored Channel” on Page 30).
- To lock out channels so the scanner does not stop for a transmission on those channels, see “Locking Out Channels” on Page 32.

MONITORING A STORED CHANNEL

You can continuously monitor a specific channel without scanning. This is useful if you hear an emergency broadcast on a channel and do not want to miss any details — even though there might be periods of silence — or if you simply want to monitor that channel.

Follow these steps to manually select a channel.

1. Press **MANUAL**.

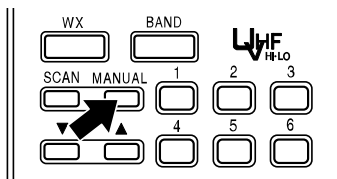

2. Enter the channel number.
3. Press **MANUAL** again.

CLEARING A STORED CHANNEL

If you no longer want a frequency stored in a channel (and you do not want to replace that frequency with a different one), follow these steps to clear the stored frequency.

1. Select the channel that you want to clear.
2. Press **PGM**. **PGM** appears on the display.
3. Press **CLEAR**. The frequency number flashes on the display.
4. Press **E/L-OUT**. **L/O** (lockout — see “Locking Out Channels” on Page 32) appears, the channel number flashes, and the frequency number changes to **000.0000** on the display to indicate the channel is cleared.

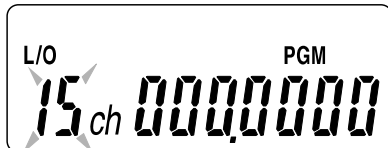

5. To clear another channel, use the number keys to enter that channel number (1-50), then press **PGM** again. Or, repeatedly press **PGM** until the desired channel number appears. Then repeat Steps 3-4.

SPECIAL FEATURES

USING THE KEYLOCK

Once you program your scanner, you can protect it from accidental program changes by turning on the keylock feature. When the keypad is locked, the only controls that operate are **LIGHT** (see “Using the Display Backlight” on Page 34), **VOLUME**, and **SQUELCH**.

Note: The keylock does not prevent the scanner from scanning channels or monitoring a single channel, whichever feature you last selected.

To turn on the keylock, press and hold **↵** for about 3 seconds until **↵** appears on the display. To turn it off, press and hold **↵** for about 3 seconds until **↵** disappears from the display.

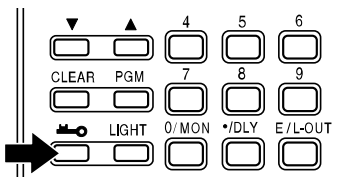

LOCKING OUT CHANNELS

You can increase the effective scanning speed by locking out individual channels that have a continuous transmission, such as a weather channel (see “National Weather Frequencies” on Page 36) or birdie frequency (see “Birdie Frequencies” on Page 37). To lock out a channel, select that channel then press **E/L-OUT**. **L/O** appears on the display.

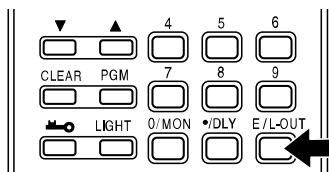

To remove the lock-out from a channel, select that channel again, then press **E/L-OUT** so **L/O** disappears from the display.

Notes:

- You can manually select locked-out channels.
- Your scanner automatically locks out empty channels.

USING A 2-SECOND DELAY

Many agencies use a two-way radio system that has a period of several seconds between a query and a reply. To avoid missing a reply, you can program a 2-second delay into any channel or frequency. When your scanner stops on a channel or frequency with a programmed delay, **DE-LAY** appears on the display and the scanner continues to monitor that frequency for 2 seconds after the transmission stops before resuming scanning.

You can program a 2-second delay in these three ways:

- If the scanner is scanning and stops on an active channel, quickly press **.DLY** before it continues scanning again.
- If the desired channel is not selected, manually select the channel, then press **.DLY**.

-
- If the scanner is in the search mode, press **.DLY** while the scanner is searching. **DELAY** appears on the display and the scanner automatically adds a 2-second delay to every transmission it stops on.

To turn off the 2-second delay, press **.DLY** while the scanner is monitoring the channel or frequency. **DELAY** disappears from the display.

USING THE DISPLAY BACKLIGHT

You can turn on the display's backlight for easy viewing in the dark. Press **LIGHT** to turn on the display light for 5 seconds. To turn off the light before 5 seconds elapse, press **LIGHT** again.

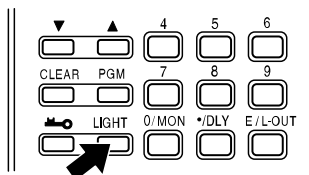

LISTENING TO A WEATHER BAND

The FCC (Federal Communications Commission) has allocated 11 channels for use by the National Oceanic and Atmospheric Administration (NOAA). NOAA broadcasts your local forecast and regional weather information on one or more of these channels. We have programmed your scanner with 10 of the U.S. frequencies most commonly used by NOAA.

To hear your local forecast and regional weather information, simply press **WX**. Your scanner begins to scan through the weather band, and **▲** and **WX** appear on the display. To reverse the scanning direction, press **▲** or **▼**.

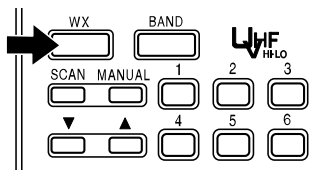

Your scanner should stop within a few seconds on your local weather broadcast. If the broadcast is weak, you can press **▲** or **▼** again to resume scanning.

Note: To manually select a preprogrammed weather channel, you can:

- repeatedly press **WX** until **MAN** appears on the display, then repeatedly press **▲** or **▼** to move forward or backward through the channels.
- press the number (**0-9**) of the channel you want to listen to.

A GENERAL SCANNING GUIDE

Reception of the frequencies covered by your scanner is mainly “line-of-sight.” This means you usually cannot hear stations that are beyond the horizon.

GUIDE TO FREQUENCIES

National Weather Frequencies

161.650	161.775	162.400	162.425
162.440*	162.450	162.475	162.500
162.525	162.550	163.275	

*Not preprogrammed in this scanner, but you can manually program it.

Ham Radio Frequencies

Ham radio operators often transmit emergency information when other means of communication break down. The following chart shows the frequencies this scanner receives that Ham radio operators normally use:

Wavelength (meters)	Frequency (MHz)
10-meter	29.000–29.700
6-meter	50.000–54.000
2-meter	144.000–148.000
70-cm	420.000–450.000

Note: Your scanner cannot receive AM transmissions on these bands.

Birdie Frequencies

Every scanner has birdie frequencies. Birdies are signals created inside the scanner's receiver. These operating frequencies might interfere with broadcasts on the same frequencies. If you program one of these frequencies, you hear only noise on that frequency. If the interference is not severe, you might be able to turn **SQUELCH** clockwise to cut out the birdie.

The birdie frequencies on this unit to watch for are:

29.900	30.455	30.735	31.480
32.090	32.530	33.580	38.400
51.200	51.225	140.800	143.430
144.000	147.200	153.600	156.800
160.000	162.200	166.400	

To find the birdies in your scanner, begin by disconnecting the antenna and moving it away from the receiver. Make sure that no other nearby radio or TV sets are turned on near the scanner. Use the search function and scan every frequency band from its lowest frequency to the highest. Occasionally, the searching will stop as if it had found a signal, often without any sound. That is a birdie. Make a list of all the birdies in your particular scanner for future reference.

GUIDE TO THE ACTION BANDS

United States Broadcast Bands

In the United States, there are several broadcast bands. The standard AM and FM bands are probably the most well known. There are also four television audio broadcast bands — the lower three transmit on the VHF band and the fourth transmits on the UHF band.

Typical Band Usage

HF Band (3.00–30.0 MHz)

10-Meter Amateur	29.00–29.70 MHz
High Range	29.70–29.90 MHz

VHF Band (30.00–300.0 MHz)

Low Range	30.00–50.00 MHz
6-Meter Amateur	50.00–54.00 MHz
U.S. Government	137.00–144.00 MHz
2-Meter Amateur	144.00–148.00 MHz
High Range	148.00–174.00 MHz

UHF Band (300.00 MHz–3.0 GHz)

Military Aircraft	380.00–384.00 MHz
U.S. Government	406.00–420.00 MHz
70-Centimeter Amateur	420.00–450.00 MHz
Low Range	450.00–470.00 MHz
FM-TV Audio Broadcast, Wide Band	470.00–512.00 MHz

Primary Usage

As a general rule, most of the radio activity is concentrated on the following frequencies:

VHF Band

Activities	Frequencies (MHz)
Government, Police, and Fire	153.785–155.980
Emergency Services	158.730–159.460
Railroad	160.000–161.900

UHF Band

Activities	Frequencies (MHz)
Land-Mobile "Paired" Frequencies	450.000–470.000
Base Stations	451.025–454.950
Mobile Units	456.025–459.950
Relay Repeater Units	460.025–464.975
Remote Control Stations	465.025–469.975

Note: Remote control stations and mobile units operate at 5 MHz higher than their associated base stations and relay repeater units.

Specified Intervals

Frequencies in different bands are accessible only at specific intervals. For example:

Frequency Range(s)	Specified Interval
29–54 and 137–144 MHz	5.0 kHz steps
380–512	12.5 kHz steps

Note: Your scanner automatically rounds the entered frequency down to the closest valid frequency. For example, if you try to enter 151.473, your scanner accepts this as 151.470.

BAND ALLOCATION

To help decide which frequency ranges to scan, use the following listing of the typical services that use the frequencies your scanner receives. These frequencies are subject to change, and might vary from area to area. For a more complete listing, refer to *Police Call Radio Guide Including Fire and Emergency Services*, available at your local RadioShack store.

Abbreviations

Services

AIR.....	Aircraft
BIFC.....	Boise (ID) Interagency Fire Cache
BUS.....	Business
CAP.....	Civil Air Patrol
CB.....	Citizens Band
CCA.....	Common Carrier
CSB.....	Conventional Systems
CTSB.....	Conventional/Trunked Systems
FIRE.....	Fire Department
HAM.....	Amateur (Ham) Radio
GOVT.....	Federal Government
GMR.....	General Mobile Radio
GTR.....	General Trunked
IND.....	Industrial Services (Manufacturing, Construction, Farming, Forest Products)
MAR.....	Military Amateur Radio
MARI.....	Maritime Limited Coast (Coast Guard, Marine telephone, Shipboard Radio, Private stations)
MARS.....	Military Affiliate Radio System
MED.....	Emergency/Medical Services
MIL.....	U.S. Military
MOV.....	Motion Picture/Video Industry
NEW.....	New Mobile Narrow
NEWS.....	Relay Press (Newspaper reporters)
OIL.....	Oil/Petroleum Industry
POL.....	Police Department
PUB.....	Public Services (Public Safety, Local Govt., Forestry Conservation)
PSB.....	Public Safety

PTR	Private Trunked
ROAD	Road & Highway Maintenance
RTV	Radio/TV Remote Broadcast Pickup
TAXI	Taxi Services
TELB	Mobile Telephone
	(Aircraft, Radio Common Carrier, Landline companies)
TELC	Cordless Phones
TELM	Telephone Maintenance
TOW	Tow Trucks
TRAN	Transportation Services
	(Trucks, Tow Trucks, Buses, Railroad, Other)
TSB	Trunked Systems
TVn	FM-TV Audio Broadcast
USXX	Government Classified
UTIL	Power & Water Utilities
WTHR	Weather

High Frequency (HF) Hi — (3 MHz–30 MHz)

10-Meter Amateur Band— (28.0–29.7 MHz)

29.000–29.700 HAM

Very High Frequency (VHF) — (30 MHz–300 MHz)

Low Band — (29.7–50 MHz — in 5 kHz steps)

29.700–29.790	IND
29.900–30.550	GOVT, MIL
30.580–31.980	IND, PUB
32.000–32.990	GOVT, MIL
33.020–33.980	BUS, IND, PUB
34.010–34.990	GOVT, MIL
35.020–35.980	BUS, PUB, IND, TELM
36.000–36.230	GOVT, MIL
36.250	Oil Spill Clean-Up
36.270–36.990	GOVT, MIL
37.020–37.980	PUB, IND
38.000–39.000	GOVT, MIL
39.020–39.980	PUB
40.000–42.000	GOVT, MIL, MARI
42.020–42.940	POL
42.960–43.180	IND
43.220–43.680	TELM, IND, PUB
43.700–44.600	TRAN
44.620–46.580	POL, PUB
46.600–46.990	GOVT, TELC

47.020–47.400..... PUB
47.420..... American Red Cross
47.440–49.580..... IND, PUB
49.610–49.990..... MIL, TELC

6-Meter Amateur Band — (50–54 MHz)

50.00–54.00..... HAM

U.S. Government Band (138–144 MHz)

137.000–144.000..... GOVT, MIL

2-Meter Amateur Band (144–148 MHz)

144.000–148.000..... HAM

VHF-Hi BAND (148–174 MHz)

148.050–150.345..... CAP, MAR, MIL
150.775–150.790..... MED
150.815–150.965..... TOW
150.980..... Oil Spill Clean Up
150.995–151.130..... ROAD
151.145–151.475..... POL
151.490–151.955..... IND, BUS
151.985..... TELM
152.0075..... MED
152.030–152.240..... TELB
152.270–152.465..... IND, TAXI
152.480..... BUS
152.510–152.840..... TELB
152.870–153.020..... IND, MOV
153.035–153.725..... IND, OIL, UTIL
153.740–154.445..... PUB, FIRE
154.490–154.570..... IND, BUS
154.585..... Oil Spill Clean-Up
154.600–154.625..... BUS
154.655–156.240..... MED, ROAD, POL, PUB
156.255..... OIL
156.275–157.425..... MARI
157.450..... MED
157.470–157.515..... TOW
157.530–157.725..... IND, TAXI
157.740..... BUS
157.770–158.100..... TELB
158.130–158.460..... BUS, IND, OIL, TELM, UTIL
158.490–158.700..... TELB
158.730–159.465..... POL, PUB, ROAD

159.480	OIL
159.495–161.565	TRAN
161.580	OIL
161.600–162.000	MARI, RTV
162.0125–162.35	GOVT, MIL, USXX
162.400–162.550	WTHR
162.5625–162.6375	GOVT, MIL, USXX
162.6625	MED
162.6875–163.225	GOVT, MIL, USXX
163.250	MED
163.275–166.225	GOVT, MIL, USXX
166.250	GOVT, RTV, FIRE
166.275–169.400	GOVT, BIFC
169.445	Wireless Mics
169.500	GOVT
169.505	Wireless Mics
169.55–169.9875	GOVT, MIL, USXX
170.000	BIFC
170.025–170.150	GOVT, RTV, FIRE
170.175–170.225	GOVT
170.245–170.305	Wireless Mics
170.350–170.400	GOVT, MIL
170.425–170.450	BIFC
170.475	PUB
170.4875–173.175	GOVT, PUB, Wireless Mics
173.225–173.375	MOV, NEWS, UTIL
173.3875–173.5375	MIL
173.5625–173.5875	MIL Medical/Crash Crews
173.60–173.9875	GOVT

Ultra High Frequency (UHF) (300 MHz–3 GHz)

Military Aircraft Band (319.1–383.9 MHz)

380.000–383.900 Coast Guard

U. S. Government Band (406–450 MHz)

406.125–419.975 GOVT, USXX

70-cm Amateur Band (420–450 MHz)

420.000–450.000 HAM

Low Band (450–470 MHz)

450.050–450.925 RTV

451.025–452.025 IND, OIL, TELM, UTIL

452.0375–453.00 IND, TAXI, TRAN TOW, NEWS

453.0125–453.9875.....	PUB
454.000.....	OIL
454.025–454.975.....	TELB
455.050–455.925.....	RTV
457.525–457.600.....	BUS
458.025–458.175.....	MED
460.0125–460.6375.....	FIRE, POL, PUB
460.650–462.175.....	BUS
462.1875–462.450.....	BUS, IND
462.4625–462.525.....	IND, OIL, TELM, UTIL
462.550–462.725.....	GMR
462.750–462.925.....	BUS
462.9375–463.1875.....	MED
463.200–467.925.....	BUS

**FM-TV Audio Broadcast,
UHF Wide Band (470–512 MHz)
(Channels 14 through 20 in 6 MHz steps)**

475.750.....	Channel 14
481.750.....	Channel 15
487.750.....	Channel 16
493.750.....	Channel 17
499.750.....	Channel 18
505.750.....	Channel 19
512.000.....	Channel 20

Note: Some cities use the 470–512 MHz band for land/mobile service.

AVOIDING IMAGE FREQUENCIES

You might discover one of your regular stations on another frequency that is not listed. This might be what is known as an image frequency. For example, you might find a service that regularly uses a frequency of 453.275 also on 474.675.

To see if it is an image, do a little math.

Note the new frequency. 474.675

Double the intermediate frequency
of 10.7 MHz (21.400) and subtract it
from the new frequency. -21.400

If the answer is the regular frequency, 453.275
then you have tuned to an image.

Occasionally you might get interference on a weak or distant channel from a strong broadcast 21.4 MHz below the tuned frequency. This is rare, and the image signal is usually cleared whenever there is a broadcast on the actual frequency.

FREQUENCY CONVERSION

The tuning location of a station can be expressed in frequency (kHz or MHz) or in wavelength (meters). The following information can help you make the necessary conversions.

$$1 \text{ MHz (million)} = 1,000 \text{ kHz (thousand)}$$

To convert MHz to kHz, multiply the number of MHz by 1,000:

$$30.62 \text{ MHz} \times 1000 = 30,620 \text{ kHz}$$

To convert from kHz to MHz, divide the number of kHz by 1,000.

$$127,800 \text{ kHz} \div 1000 = 127.8 \text{ MHz}$$

To convert MHz to meters, divide 300 by the number of MHz.

$$300 \div 50 \text{ MHz} = 6 \text{ meters}$$

TROUBLESHOOTING

If your scanner is not working as it should, these suggestions might help you eliminate the problem. If the scanner still does not operate properly, take it to your local RadioShack store for assistance.

PROBLEM	POSSIBLE CAUSES	REMEDIES
Scanner is totally inoperative.	The batteries are dead.	Replace the batteries with fresh ones or recharge the battery pack.
	The optional AC or DC power adapter is not connected.	Be sure the adapter is fully inserted into the PWR/DC 9V jack.
Poor or no reception	Improperly connected antenna.	Be sure the antenna is properly connected.
	Programmed frequencies are the same as birdie frequencies.	Avoid programming frequencies listed under "Birdie Frequencies" on Page 37 or only select them manually.
Error appears on the display.	Programming error.	Reprogram the frequency correctly.
Keypad does not work.	Keylock is turned on.	Turn off keylock.

PROBLEM	POSSIBLE CAUSES	REMEDIES
Keys do not work or display changes.	Undetermined error.	Turn the scanner off then on again, or reset the scanner (see "Resetting/Initializing the Scanner" on Page 49).
Scanner is on but will not scan.	SQUELCH is not correctly adjusted.	Adjust SQUELCH clockwise (see "Turning On the Scanner and Setting SQUELCH" on Page 21).
In the scan mode, the scanner locks on frequencies that have an unclear transmission.	Birdies.	Avoid programming frequencies listed under "Birdie Frequencies" on Page 37 or only listen to them manually.

RESETTING/INITIALIZING THE SCANNER

If the scanner's display locks up or does not work properly after you connect a power source, you might need to reset or initialize the scanner.

IMPORTANT! If you have problems, first try to reset the scanner (see "Resetting the Scanner"). If that does not work, you can initialize the scanner (see "Initializing the Scanner" on Page 50); however, this clears all information stored in your scanner's memory.

Resetting the Scanner

1. Turn off the scanner, then turn it on again.
2. Insert a pointed object, such as a straightened paper clip, into the reset opening on the side of the scanner (as shown below) and gently press then release the reset button inside the opening.

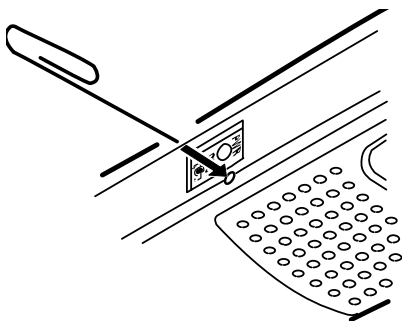

Note: If the scanner still does not work properly, you might need to initialize the scanner (see "Initializing the Scanner" on Page 50).

Initializing the Scanner

Caution: This procedure clears all information you stored in the scanner's memory. Initialize the scanner only when you are sure the scanner is not working properly.

1. Turn off the scanner, then turn it on again.
2. Press and hold **CLEAR**.
3. While holding down **CLEAR**, insert a pointed object, such as a straightened paper clip, into the reset opening on the side of the scanner and gently press then release the reset button inside the opening.
4. When the display reappears, release **CLEAR**.

Note: You must release **RESET** before releasing **CLEAR**, otherwise the memory might not clear.

CARE AND MAINTENANCE

To enjoy your RadioShack PRO-70 50-Channel Portable Scanner for a long time:



Keep the scanner dry. If it gets wet, wipe it dry immediately. Liquids can contain minerals that can corrode the electronic circuits.



Use only fresh batteries of the recommended size and type. Always remove old and weak batteries. They can leak chemicals that destroy electronic circuits.



Handle the scanner gently and carefully. Dropping it can damage circuit boards and cases and can cause the scanner to work improperly.



Use and store the scanner only in normal temperature environments. Temperature extremes can shorten the life of electronic devices, damage batteries, and distort or melt plastic parts.



Keep the scanner away from dust and dirt, which can cause premature wear of parts.



Wipe the scanner with a damp cloth occasionally to keep it looking new. Do not use harsh chemicals, cleaning solvents, or strong detergents to clean the scanner.

Modifying or tampering with the scanner's internal components can cause a malfunction and might invalidate its warranty and void your FCC authorization to operate it. If your scanner is not operating as it should, take it to your local RadioShack store for assistance.

SPECIFICATIONS

Frequency Coverage:

Ham	29–30 MHz (5.0 kHz steps)
VHF Lo	30–50 MHz (5.0 kHz steps)
Ham	50–54 MHz (5.0 kHz steps)
Government.....	137–144 MHz (5.0 kHz steps)
Ham	144–148 MHz (5.0 kHz steps)
VHF Hi	148–174 MHz (5.0 kHz steps)
Ham/Government	380–450 MHz (12.5 kHz steps)
UHF Lo	450–470 MHz (12.5 kHz steps)
UHF Hi (T)	470–512 MHz (12.5 kHz steps)

Channels of Operation: 50 Channels
and 1 Monitor Memory

Sensitivity (20 dB S/N):

29–54 MHz	1.0 μ V
137–174 MHz	1.0 μ V
380–512 MHz	1.0 μ V

Selectivity:

\pm 10 kHz	-6 dB
\pm 18 kHz	-50 dB

Spurious Rejection:

29–54 MHz	50 dB at 40 MHz
137–174 MHz	50 dB at 154 MHz

Scanning Rate Up to 25 channels/second

Search Rate Up to 50 steps/second

Delay Time 2 seconds

Intermediate Frequencies (IF):

1st.....	10.7 MHz
2nd.....	455 kHz

IF Rejection: 10.7 MHz 70 dB at 154 MHz

Squelch Sensitivity:

Threshold.....	Less than 1.0 μ V
Tight.....	(S+N)/N 25 dB

Antenna Impedance..... 50 Ohms

Audio Output Power (10%THD).....	200 mW Nominal
Built-in Speaker	1 ³ / ₈ Inch (36 mm) 8 ohm, Dynamic Type
Power Requirements	+9 V DC, 6 AA batteries
	AC Adapter (Cat. No. 273-1665)
	DC Adapter (Cat. No. 270-1560)
	Rechargeable Battery Pack (Cat. No. 23-288)
Current Drain (Squelched)	50 mA
Dimensions (HWD)	6 ³ / ₄ × 2 ⁷ / ₁₆ × 1 ⁹ / ₁₆ Inches
	(171 × 62 × 40 mm)
Weight.....	8.1 oz
	(229 g)
Supplied Accessory	Antenna

Specifications are typical; individual units might vary.
 Specifications are subject to change and improvement
 without notice.

NOTES



Limited One-Year Warranty

This product is warranted by RadioShack against manufacturing defects in material and workmanship under normal use for one (1) year from the date of purchase from RadioShack company-owned stores and authorized RadioShack franchisees and dealers. EXCEPT AS PROVIDED HEREIN, RadioShack MAKES NO EXPRESS WARRANTIES AND ANY IMPLIED WARRANTIES, INCLUDING THOSE OF MERCHANTABILITY AND FITNESS FOR A PARTICULAR PURPOSE, ARE LIMITED IN DURATION TO THE DURATION OF THE WRITTEN LIMITED WARRANTIES CONTAINED HEREIN. EXCEPT AS PROVIDED HEREIN, RadioShack SHALL HAVE NO LIABILITY OR RESPONSIBILITY TO CUSTOMER OR ANY OTHER PERSON OR ENTITY WITH RESPECT TO ANY LIABILITY, LOSS OR DAMAGE CAUSED DIRECTLY OR INDIRECTLY BY USE OR PERFORMANCE OF THE PRODUCT OR ARISING OUT OF ANY BREACH OF THIS WARRANTY, INCLUDING, BUT NOT LIMITED TO, ANY DAMAGES RESULTING FROM INCONVENIENCE, LOSS OF TIME, DATA, PROPERTY, REVENUE, OR PROFIT OR ANY INDIRECT, SPECIAL, INCIDENTAL, OR CONSEQUENTIAL DAMAGES, EVEN IF RadioShack HAS BEEN ADVISED OF THE POSSIBILITY OF SUCH DAMAGES.

Some states do not allow the limitations on how long an implied warranty lasts or the exclusion of incidental or consequential damages, so the above limitations or exclusions may not apply to you.

In the event of a product defect during the warranty period, take the product and the RadioShack sales receipt as proof of purchase date to any RadioShack store. RadioShack will, at its option, unless otherwise provided by law: (a) correct the defect by product repair without charge for parts and labor; (b) replace the product with one of the same or similar design; or (c) refund the purchase price. All replaced parts and products, and products on which a refund is made, become the property of RadioShack. New or reconditioned parts and products may be used in the performance of warranty service. Repaired or replaced parts and products are warranted for the remainder of the original warranty period. You will be charged for repair or replacement of the product made after the expiration of the warranty period.

This warranty does not cover: (a) damage or failure caused by or attributable to acts of God, abuse, accident, misuse, improper or abnormal usage, failure to follow instructions, improper installation or maintenance, alteration, lightning or other incidence of excess voltage or current; (b) any repairs other than those provided by a RadioShack Authorized Service Facility; (c) consumables such as fuses or batteries; (d) cosmetic damage; (e) transportation, shipping or insurance costs; or (f) costs of product removal, installation, set-up service adjustment or reinstallation.

This warranty gives you specific legal rights, and you may also have other rights which vary from state to state.

RadioShack Customer Relations, Dept. W,
100 Throckmorton St., Suite 600, Fort Worth, TX 76102

We Service What We Sell

3/97

RadioShack
A Division of Tandy Corporation
Fort Worth, Texas 76102