

Radio Shack®

ServiceManual

20-224/9224

**DX-394
GENERAL COVERAGE
COMMUNICATIONS RECEIVER**

Catalog Number: 20-224/9224

CONTENTS

	Page
Specifications	2
Block Diagram	4
Theory of Operation	5
General Operation Outline	6
Reception Check	8
Memory Check	9
Alignment and Adjustment	10
Troubleshooting	16
Printed Circuit Boards	18
Wiring Diagram	22
Exploded View	23
Mechanical Parts List	24
Electrical Parts List	25
Semiconductor Lead Identification	56
Microprocessor (IC201) Port Format	61
Schematic Diagram	62

SPECIFICATIONS

Frequency range 150 kHz to 29.9999 MHz
 Receiving mode AM, CW, LSB, and USB

			Unit	Nominal	Limit	
Sensitivity	AM	180 kHz	μV	10	20	
		480 kHz	μV	5	20	
		630 kHz	μV	7	15	
		1610 kHz	μV	4	15	
		2 MHz	μV	1	2	
		4.2 MHz	μV	1	2	
		5.18 MHz	μV	1	2	
		10.88 MHz	μV	1	2	
		13.43 MHz	μV	2	4	
		28.16 MHz	μV	1	2	
		SSB	2 MHz	μV	0.3	1
			4.2 MHz	μV	0.3	1
			5.18 MHz	μV	0.3	1
	10.88 MHz		μV	0.3	1	
	13.43 MHz		μV	0.7	2	
	CW	28.16 MHz	μV	0.3	1	
		2 MHz	μV	0.15	1	
		4.2 MHz	μV	0.15	1	
		5.18 MHz	μV	0.15	1	
		10.88 MHz	μV	0.15	1	
13.43 MHz		μV	0.3	2		
Selectivity	AM	28.16 MHz	μV	0.15	1	
		-6 dB	kHz	±3.5	±2	
	SSB/CW	-50 dB	kHz	±7	±10	
		-6 dB	kHz	6	3	
		-50 dB	kHz	15	20	
Image ratio	10 MHz		dB	70	60	
Spurious rejection	10 MHz		dB	60	50	
IF rejection	45 MHz		dB	60	50	
Signal to noise ratio	AM (30% Mod. at 1 kHz, 1 mV input)		dB	45	35	
AGC figure of merit	10 MHz (100mA)	AM	dB	90	75	
Fine tuning step			Hz	50	Not specified	
Scanning rate			channels/sec.	8	7-9	
Audio output power	10% THD		watt	0.8	0.5	
Noise blanker sensitivity	AM 30% Mod.	AM	dB	1	5	
		SSB	dB	2	5	
Clock accuracy			sec/month	10	30	

Channels of operation	160 channels (13 bank) and 1 monitor channel
Channel, frequency and mode display	Liquid crystal display
Receiving system	Direct key entry and rotary tuning PLL synthesizer dual superheterodyne 1st IF: 45 MHz 2nd IF: 455 kHz
Power source	AC 120 volts, 60 Hz, 13 watts DC 13.8 volts, 8watts
Jacks	Headphone, Lo-impedance antenna, Hi-impedance antenna, tape out, external speaker, DC power jacks
Dimension	3 1/2 x 9 1/8 x 7 7/8 inches (90 x 232 x 200 mm)
Weight	approx. 53 oz. (1.5 kg)

Note: Nominal specs represent the design specs. All units should be able to approximate these—some will exceed and some may drop slightly below these specs. Limit specs represent the absolute worst condition that still might be considered acceptable; in no case should a unit fail to meet limit specs.

PRODUCT SAFETY NOTICE

Many electrical and mechanical parts in this chassis have special safety characteristics. These characteristics often pass unnoticed and the protection afforded by them cannot necessarily be obtained by using replacement components rated for higher voltage, wattage, etc. Replacement parts that have these special safety characteristics are identified in this manual and its supplements; electrical components having such features are identified by \triangle in the schematic diagram and the parts list.

Before replacing any of these components, read the parts list in this manual carefully. The use of substitute replacement parts that do not have the same safety characteristics as specified in the parts list may create shock, fire, or other hazards.

THEORY OF OPERATION

The DX-394 is a PLL (Phase-Locked Loop) synthesized LW/MW/SW, AM/SSB/CW receiver with timer program, controlled by a CPU (Central Processing Unit) via a keyboard, mode selector and tuning knobs.

Receiving mode can be set to AM (Amplitude Modulation), USB (Upper Side Band), LSB (Lower Side Band), CW1 (Continuous Wave 1), or CW2 using mode selector. Frequency tuning can be done by main tuning after selecting LW, MW, or SW using BAND key or the international shortwave broadcast using METER key or by directly keying in a frequency after pressing METER key. Default frequency step settings are 10 kHz in the LW band, 10 kHz in the MW band and 5 kHz in the SW band, but 1 kHz in the ham band. If you press and hold STEP, \wedge or \vee key then press POWER key to power on, frequency step changes 9 kHz with MW band.

All functions, such as receiving frequency range, frequency determination, scanning, and tuning steps are controlled by the CPU. This CPU performs only assigned functions and no modification to it is feasible.

The following paragraphs explain the operation of the circuit in terms of the functional blocks:

The RF input circuit consists of T2-T5, D8 and associated components. The signal generated by 1st LO (Local Oscillator) is applied to the 1st mixer and mixed with the RF signal. The 1st mixer is employed to facilitate 150 kHz to 29.9999 MHz mixing.

The 1st IF (Q5) is 45 MHz \pm 2.5 kHz, and the signal is mixed with 2nd LO frequency at the 2nd mixer (Q6) to produce a 455 kHz signal. While the 1st LO VCO frequency varies every 5 kHz step, any desired frequency can be received by varying the 2nd LO frequency within 44.545 MHz \pm 2.5 kHz under CPU control. The signal is further amplified to be detected as an AF signal.

BFO (Beat Frequency Oscillator) is used for detecting SSB (Single Side Band) and CW. The unit assigns 451.5 kHz to LSB frequency and 458.5 kHz to USB frequency.

X201 (4.5 MHz) is a ceramic oscillator which is used for the CPU master control. X202 (32.768 kHz) is crystal oscillator which is used for clock.

In the event of power failure and/or power-down, memory backup operates using a battery. The battery recharges fully in about four days. Fully recharged battery provides memory backup for more than one month.

GENERAL OPERATION OUTLINE

Clock Set And Timer Operation

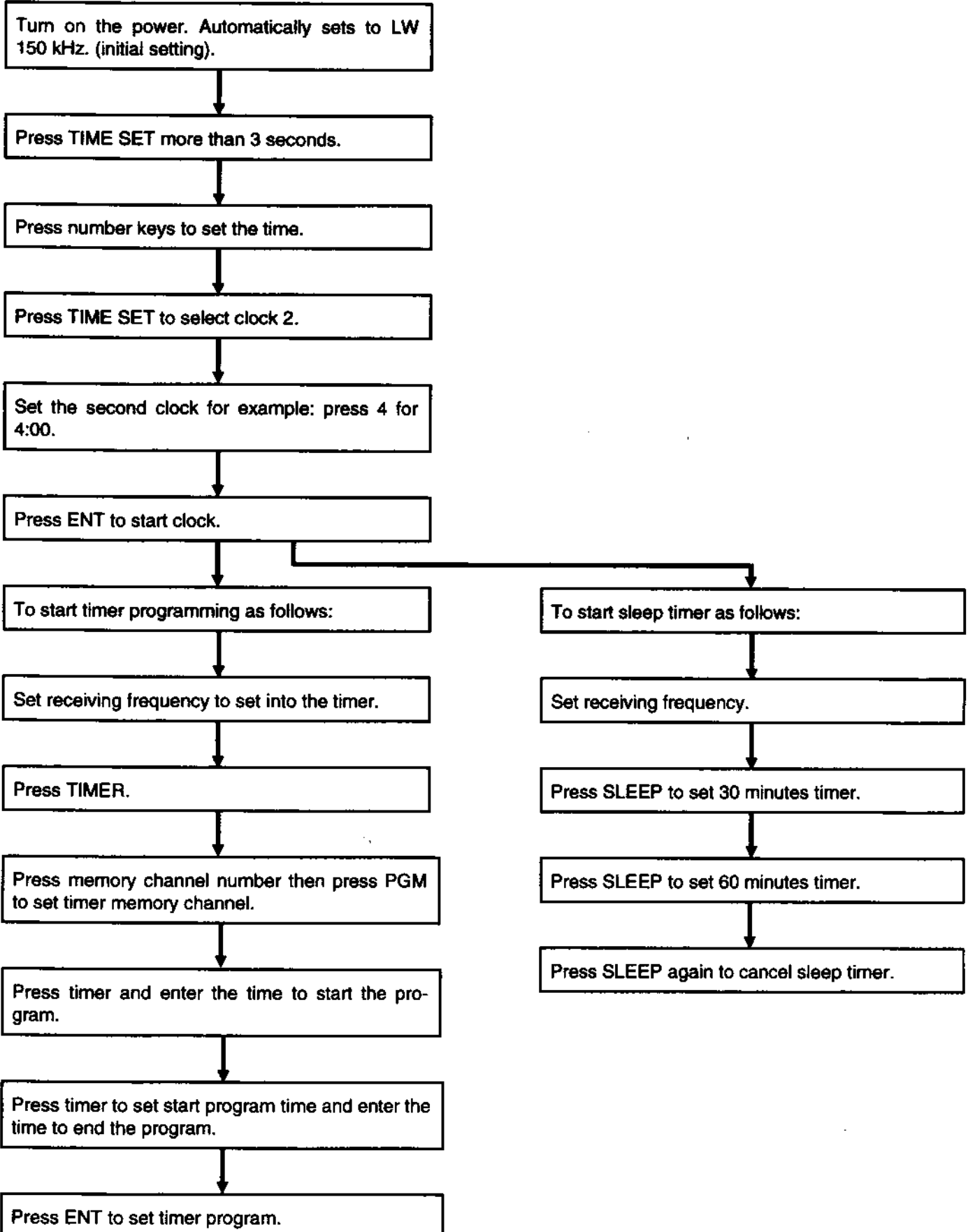

MEMORY CHECK

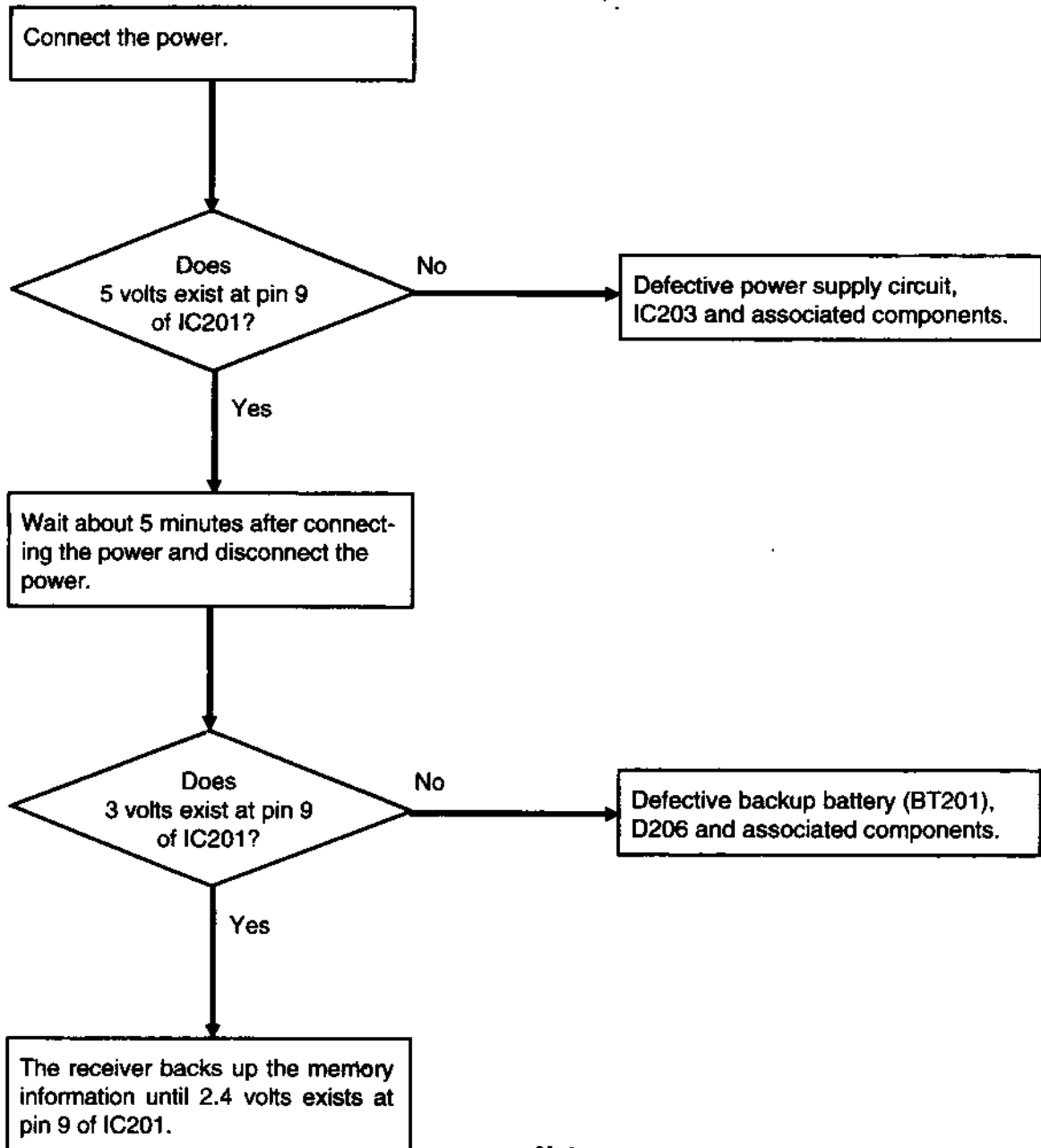

Notes:

- Prior to checking the CPU system, measure the supply voltage to the ICs. (See the schematic diagram.)
- While checking the following items, the ICs can "lock up." If this happens, push the reset switch for about one second and then continue checking. Be sure the power is present when doing this check.

ALIGNMENT AND ADJUSTMENT

ALIGNMENT AND TEST POINT LOCATIONS

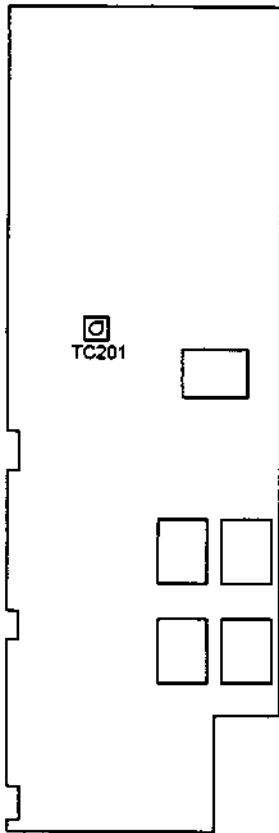

Logic PCB

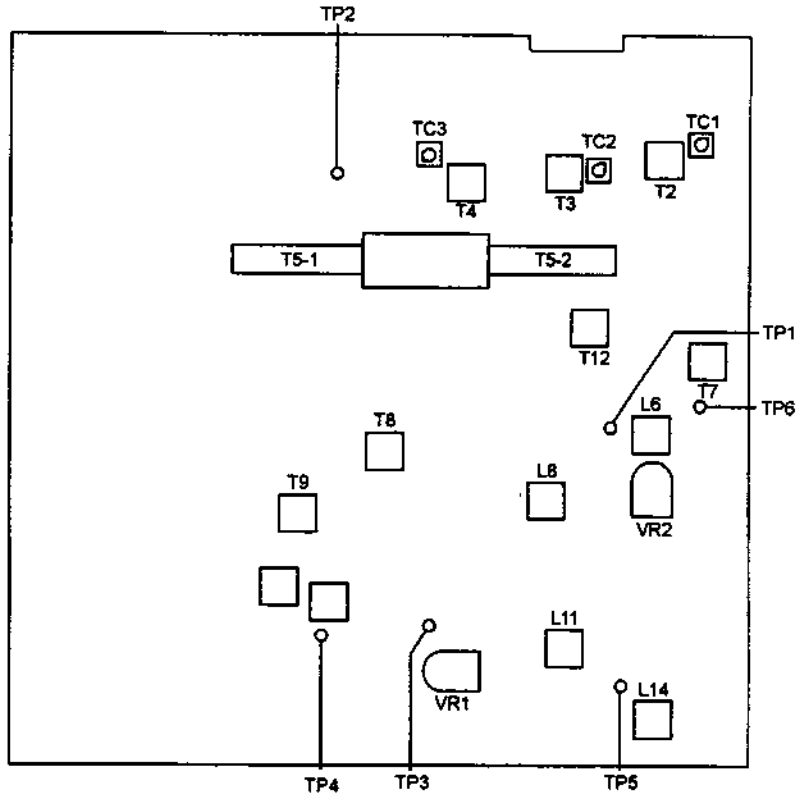

Linear PCB

ALIGNMENT PREPARATION

Test Equipments Required

- Quartz sensor (32.768 kHz)
- AC SSVM
- DC SSVM
- Frequency counter
- AM signal generator
- Pulse generator

Notes:

- Use non-metallic tuning tools.
- The test equipment and receiver should be warmed up for at least 10 minutes before proceeding with alignment.
- The signal level from the generator should be kept as low as possible to obtain an usable output.

Before alignment, program test frequencies as follows:

1. Press and hold 1 and ENT key then press POWER key to turn on the LCD.
2. LCD displays all segments.
3. Press POWER key again to turn on the receiver.

ALIGNMENT PROCEDURES

Clock Alignment

Control Setting	Test Instrument Connection	Adjust	Result
Power switch: ON.	Set quartz sensor (32.768 kHz) to test set.	TC201	Adjust TC201 for 0.25 sec/DAY on the quartz sensor.

VCO Alignment

Control Setting	Test Instrument Connection	Adjust	Result
Power switch: ON.	Connect DC SSVM to TP5 and connect frequency counter to TP6. See Figure 1	L14 L11	<ol style="list-style-type: none">1. Press MON to receive 29.999 MHz, and check 21 ± 0.5 volts on the DC SSVM.2. Press MON again to receive 150 kHz and adjust L14 for 21 ± 0.5 volts on the DC SSVM.3. Adjust L11 for $45.150 \text{ MHz} \pm 10 \text{ Hz}$ on the frequency counter.

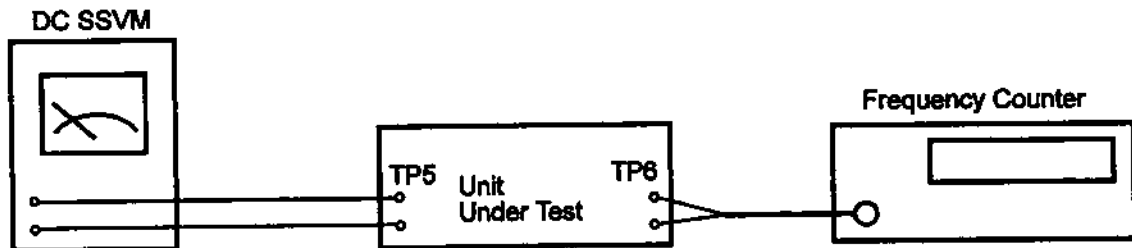

Figure 1

2nd Local OSC Alignment

Control Setting	Test Instrument Connection	Adjust	Result
Power switch: ON. Receive mode: AM.	Connect frequency counter to TP1 through 100 pF capacitor. See Figure 2	VR2 L6	<ol style="list-style-type: none"> 1. Press BAND to select LW band then press 4 to receive 332.5 kHz and adjust VR2 for $44.5475 \text{ MHz} \pm 10 \text{ Hz}$ on the frequency counter. 2. Press 6 to receive 337.4 kHz and adjust L6 for $44.54255 \text{ MHz} \pm 10 \text{ Hz}$ on the frequency counter. 3. Repeat steps 1 and 2 until no further improvement is observed. 4. Press 5 and check frequency counter to $44.545 \text{ MHz} \pm 200 \text{ Hz}$.

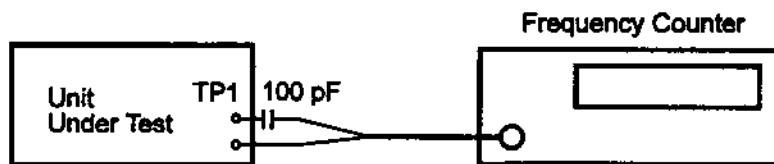

Figure 2

IF Alignment

Control Setting	Test Instrument Connection	Adjust	Result
Power switch: ON. Receive mode: AM.	Connect signal generator to Lo-Z ANT jack and AC SSVM, oscilloscope, frequency counter, and 8-ohm dummy load to EXT SPKR (J4) jack. See Figure 3.	T7 T12 T8 T9 L8	<ol style="list-style-type: none"> 1. Press BAND to select SW band then press 0 key to receive 10 MHz. 2. Set the signal generator to 10 MHz, 30% modulation with 1 kHz and adjust T7, T12, T8, T9, and L8 for maximum output. Keep output of the signal generator as low as possible during alignment.

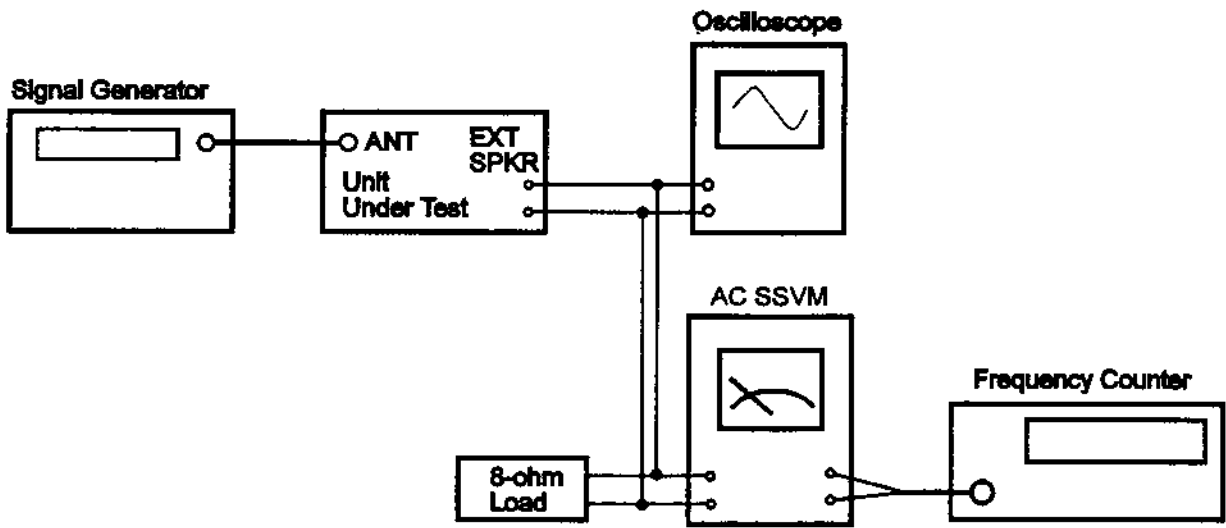

Figure 3

RF Alignment

Control Setting	Test Instrument Connection	Adjust	Result
Power switch: ON. Receive mode: AM.	Same as IF alignment	L5-2	<ol style="list-style-type: none"> 1. Press BAND to select LW band then press 2 to receive 150 kHz and set signal generator to 150 kHz. 2. Adjust L5-2 to maximum output.
Same as above.	Same as above	L5-1	<ol style="list-style-type: none"> 1. Press BAND to select MW band then press 2 to receive 1000 kHz and set signal generator to 1000 kHz. 2. Adjust L5-1 to maximum output.

Control Setting	Test Instrument Connection	Adjust	Result
Power switch: ON. Receive mode: AM.	Same as IF alignment	T4 TC3	<ol style="list-style-type: none"> 1. Press BAND to select SW band then press 1 to receive 2 MHz and set signal generator to 2 MHz. 2. Adjust T4 for maximum output. 3. Press 3 to receive 4.2 MHz and set signal generator to 4.2 MHz. 4. Adjust TC3 for maximum output. 5. Repeat steps 1 to 4 until no further improvement is observed.
Same as above.	Same as above.	T3 TC2	<ol style="list-style-type: none"> 1. Press 4 to receive 5.18 MHz and set signal generator to 5.18 MHz. 2. Adjust T3 for maximum output. 3. Press 6 to receive 10.88 MHz and set signal generator to 10.88 MHz. 4. Adjust TC2 for maximum output. 5. Repeat steps 1 to 4 until no further improvement is observed.
Same as above.	Same as above	T2 TC1	<ol style="list-style-type: none"> 1. Press 7 to receive 13.43 MHz and set signal generator to 13.43 MHz. 2. Adjust T2 for maximum output. 3. Press 9 to receive 28.16 MHz and set signal generator to 28.16 MHz. 4. Adjust TC1 for maximum output. 5. Repeat steps 1 to 4 until no further improvement is observed.

Noise Blanker Alignment

Control Setting	Test Instrument Connection	Adjust	Result
<p>Power switch: ON.</p> <p>Receive mode: AM.</p>	<p>Connect signal generator with pulse generator to ANT (Lo-Z) jack and connect oscilloscope to TP3. See Figure 4.</p>	<p>VR1</p>	<ol style="list-style-type: none"> 1. Press BAND to select SW band then press 0 key to receive the 10 MHz signal. 2. Press NB key to activate the noise blanker and rotate VR1 fully counterclockwise. 3. Set the signal generator frequency to 10 MHz, modulation frequency 1 kHz and 30% modulation. 4. Adjust the signal generator output to set (S+N)/N to about 10 dB and set AF output to obtain 1 V p-p on the oscilloscope at the EXT SPKR jack. 5. Set the pulse generator pulse to pulse width: 1 μs and duty cycle: 1 ms and adjust the AF output to read 2 V p-p at the EXT SPKR jack. 6. Check noise waveform on the oscilloscope connected to TP3 for 0.5~0.7 V. 7. Turn on the signal generator modulation and adjust VR1 to mute the audio output during noise period.

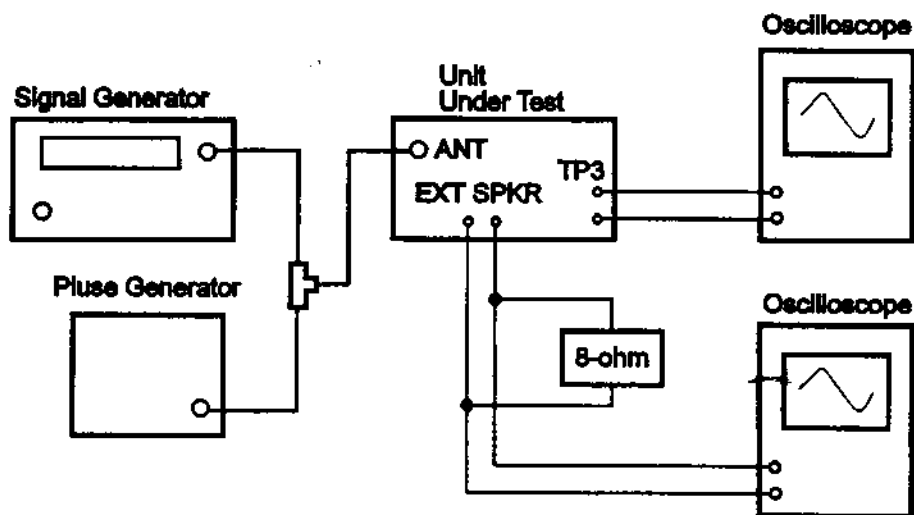

Figure 4

TROUBLESHOOTING

Symptom	Possible Cause/Remedy
<p>Display does not light and no sound comes out when power is on</p> <p>Volume control: Maximum (MAX)</p>	<ul style="list-style-type: none"> • Defective power cord: Replace. • Defective external power jack: Replace. • Defective keyboard: Replace.
<p>Display lights but there is no sound</p> <p>Volume control: MAX</p>	<ul style="list-style-type: none"> • Defective speaker or headphone jack: Replace. • Defective audio amplifier IC4 and/or associated circuit: Replace the defective components. • Defective mute control Q31, Q33 and/or associated circuit Replace the defective components. • Defective IF amplifier Q7, Q8 and/or associated circuit: Replace the defective components. • Defective volume control VR202 and/or associated circuit: Replace the defective components. • Defective AF pre-amp Q28 and/or associated circuit: Replace the defective components. • Defective switching circuit IC3 and/or associated circuit: Replace the defective components.
<p>Sound comes out but display does not light or dimmer</p> <p>Volume control: MAX</p>	<ul style="list-style-type: none"> • Defective LCD or rubber connector: Replace the defective components. • Defective dimmer control Q201 and/or associated circuit: Replace the defective components. • Defective CPU IC201 and/or associated circuit: Replace the defective components.
<p>Sound does not come out in AM mode but SSB or CW operates</p>	<ul style="list-style-type: none"> • Defective analogue switch IC3 (1/4) and/or associated circuit: Replace the defective components.

Noise Blanker Alignment

Control Setting	Test Instrument Connection	Adjust	Result
<p>Power switch: ON. Receive mode: AM.</p>	<p>Connect signal generator with pulse generator to ANT (Lo-Z) jack and connect oscilloscope to TP3. See Figure 4.</p>	<p>VR1</p>	<ol style="list-style-type: none"> 1. Press BAND to select SW band then press 0 key to receive the 10 MHz signal. 2. Press NB key to activate the noise blanker and rotate VR1 fully counterclockwise. 3. Set the signal generator frequency to 10 MHz, modulation frequency 1 kHz and 30% modulation. 4. Adjust the signal generator output to set (S+N)/N to about 10 dB and set AF output to obtain 1 V p-p on the oscilloscope at the EXT SPKR jack. 5. Set the pulse generator pulse to pulse width: 1 μs and duty cycle: 1 ms and adjust the AF output to read 2 V p-p at the EXT SPKR jack. 6. Check noise waveform on the oscilloscope connected to TP3 for 0.5–0.7 V. 7. Turn on the signal generator modulation and adjust VR1 to mute the audio output during noise period.

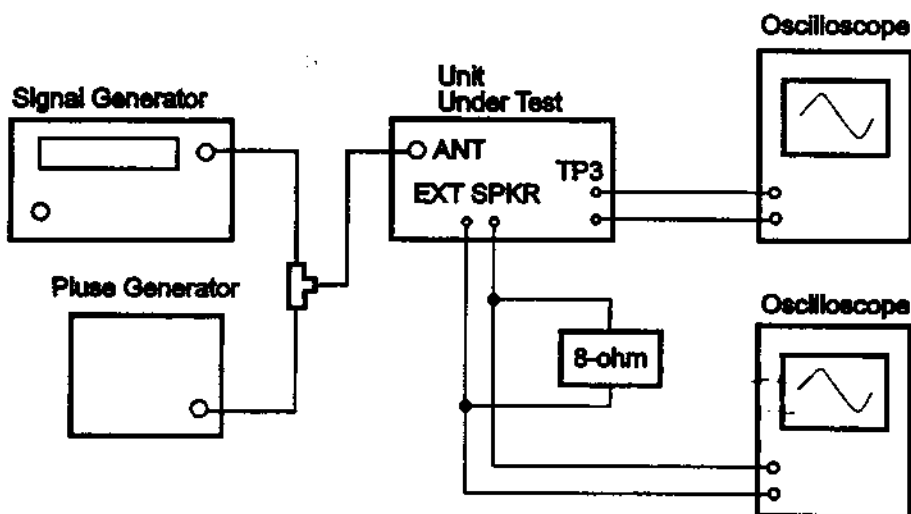

Figure 4

TROUBLESHOOTING

Symptom	Possible Cause/Remedy
<p>Display does not light and no sound comes out when power is on</p> <p>Volume control: Maximum (MAX)</p>	<ul style="list-style-type: none"> • Defective power cord: Replace. • Defective external power jack: Replace. • Defective keyboard: Replace.
<p>Display lights but there is no sound</p> <p>Volume control: MAX</p>	<ul style="list-style-type: none"> • Defective speaker or headphone jack: Replace. • Defective audio amplifier IC4 and/or associated circuit: Replace the defective components. • Defective mute control Q31, Q33 and/or associated circuit Replace the defective components. • Defective IF amplifier Q7, Q8 and/or associated circuit: Replace the defective components. • Defective volume control VR202 and/or associated circuit: Replace the defective components. • Defective AF pre-amp Q28 and/or associated circuit: Replace the defective components. • Defective switching circuit IC3 and/or associated circuit: Replace the defective components.
<p>Sound comes out but display does not light or dimmer</p> <p>Volume control: MAX</p>	<ul style="list-style-type: none"> • Defective LCD or rubber connector: Replace the defective components. • Defective dimmer control Q201 and/or associated circuit: Replace the defective components. • Defective CPU IC201 and/or associated circuit: Replace the defective components.
<p>Sound does not come out in AM mode but SSB or CW operates</p>	<ul style="list-style-type: none"> • Defective analogue switch IC3 (1/4) and/or associated circuit: Replace the defective components.

Symptom	Possible Cause/Remedy
Sound does not come out in SSB or CW mode but AM operates	<ul style="list-style-type: none"> • Defective switching circuit Q21, Q22 and/or associated circuit: Replace the defective components. • Defective BFO Q16, Q17, Q18, Q19 and/or associated circuit: Replace the defective components. • Defective analogue switch IC3 (2/4), (3/4) and/or associated circuit: Replace the defective components. • Defective SSB/CW detector D22 and/or associated circuit.
Low sensitivity between 150 and 509.9 kHz	<ul style="list-style-type: none"> • Defective switching circuit Q202, D7 (1/2), D14 (1/2) and/or associated circuit: Replace the defective components. • Defective T5-1: Replace the defective components.
Low sensitivity between 510 and 1729.9 kHz	<ul style="list-style-type: none"> • Defective switching circuit Q203, D7 (1/2), D14 (1/2) and/or associated circuit: Replace the defective components. • Defective T5-2: Replace the defective components.
Low sensitivity between 1.73 and 4.4779 MHz	<ul style="list-style-type: none"> • Defective switching circuit Q204, D6, D12, D13 and/or associated circuit: Replace the defective components. • Defective T4: Replace the defective components.
Low sensitivity between 4.478 and 11.5899 MHz	<ul style="list-style-type: none"> • Defective switching circuit Q205, D5, D10, D11 and/or associated circuit: Replace the defective components. • Defective T3: Replace the defective components.
Low sensitivity between 11.59 and 29.9999 MHz	<ul style="list-style-type: none"> • Defective switching circuit Q206, D4, D9 and/or associated circuit: Replace the defective components. • Defective T2: Replace the defective components.
All bands do not operate but display is OK	<ul style="list-style-type: none"> • Defective PLL IC1 and/or associated circuit: Replace the defective components.
Does not make beep tone	<ul style="list-style-type: none"> • Defective IC201 and/or associated circuit: Replace the defective components.

PRINTED CIRCUIT BOARD

LINEAR

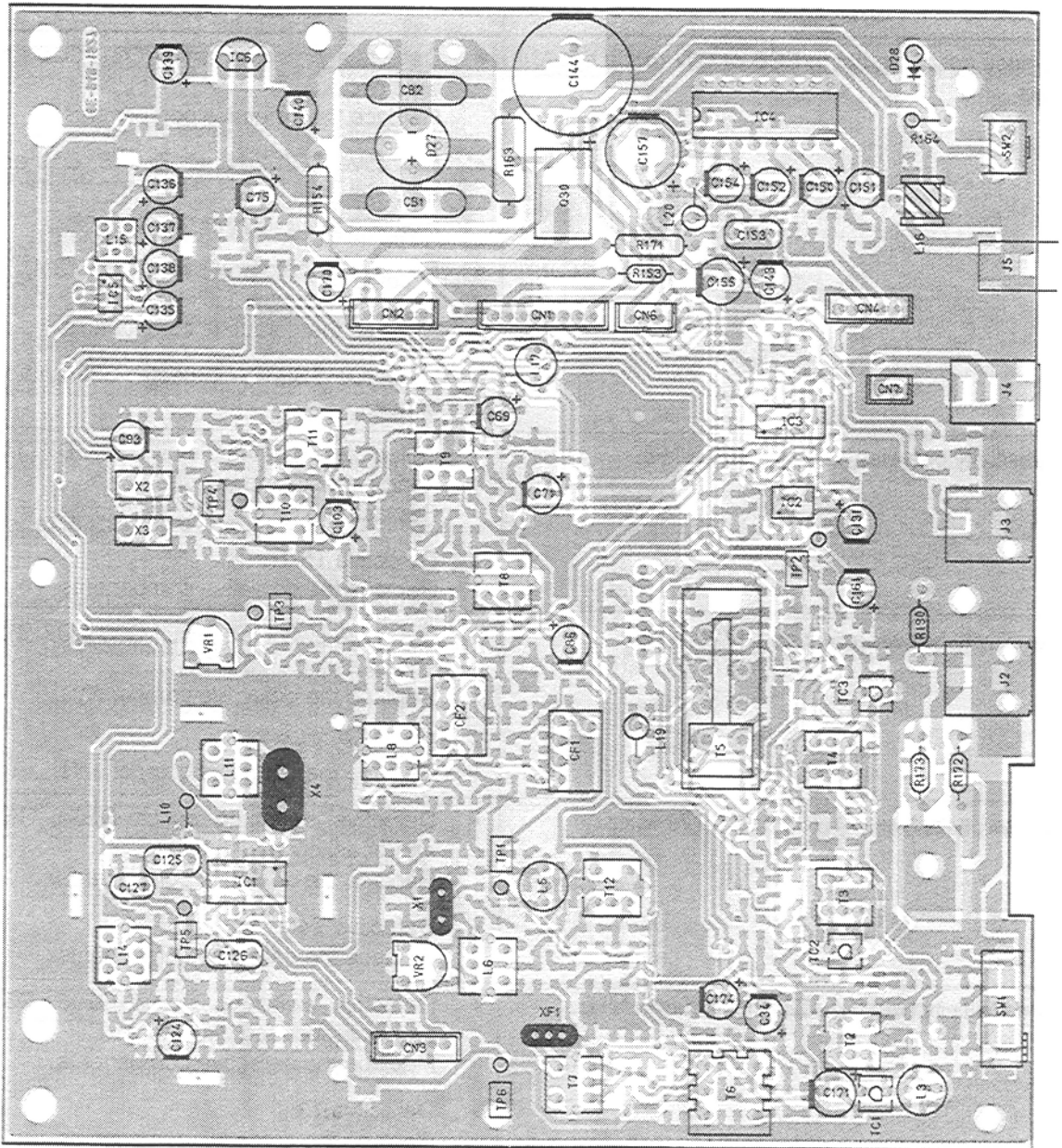

HEADPHONE

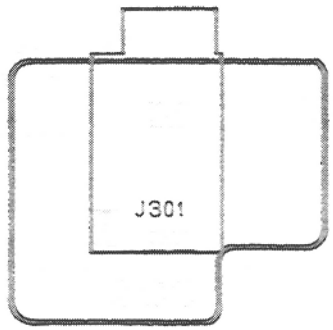

Top View

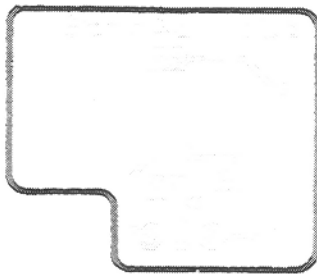
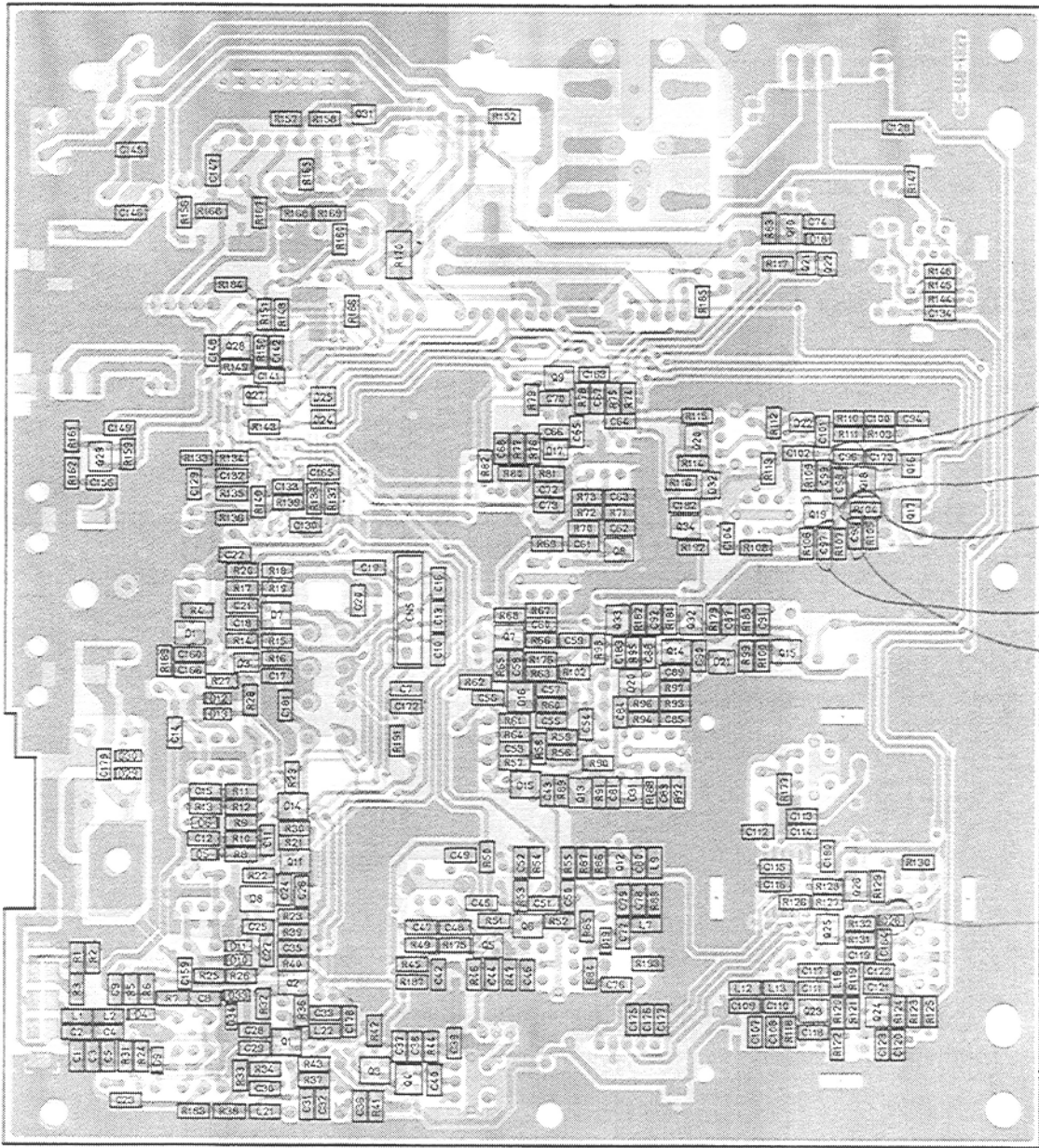

Bottom View

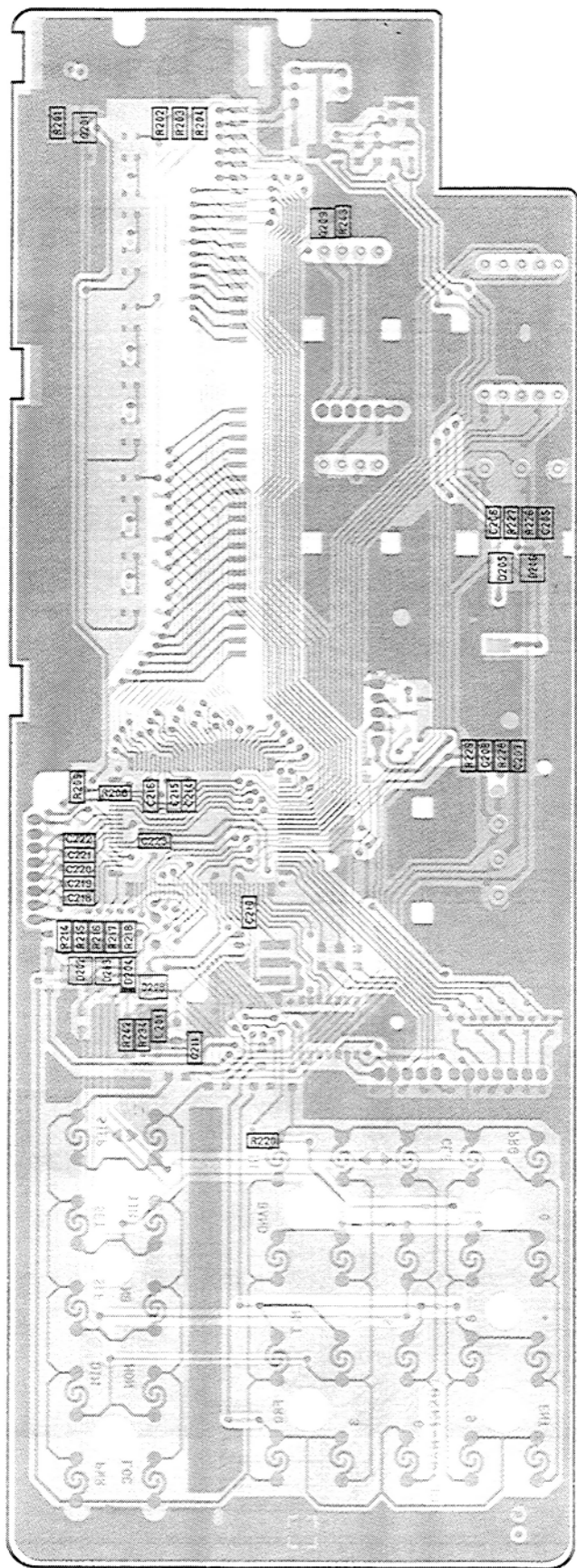

Bottom View

WIRING DIAGRAM

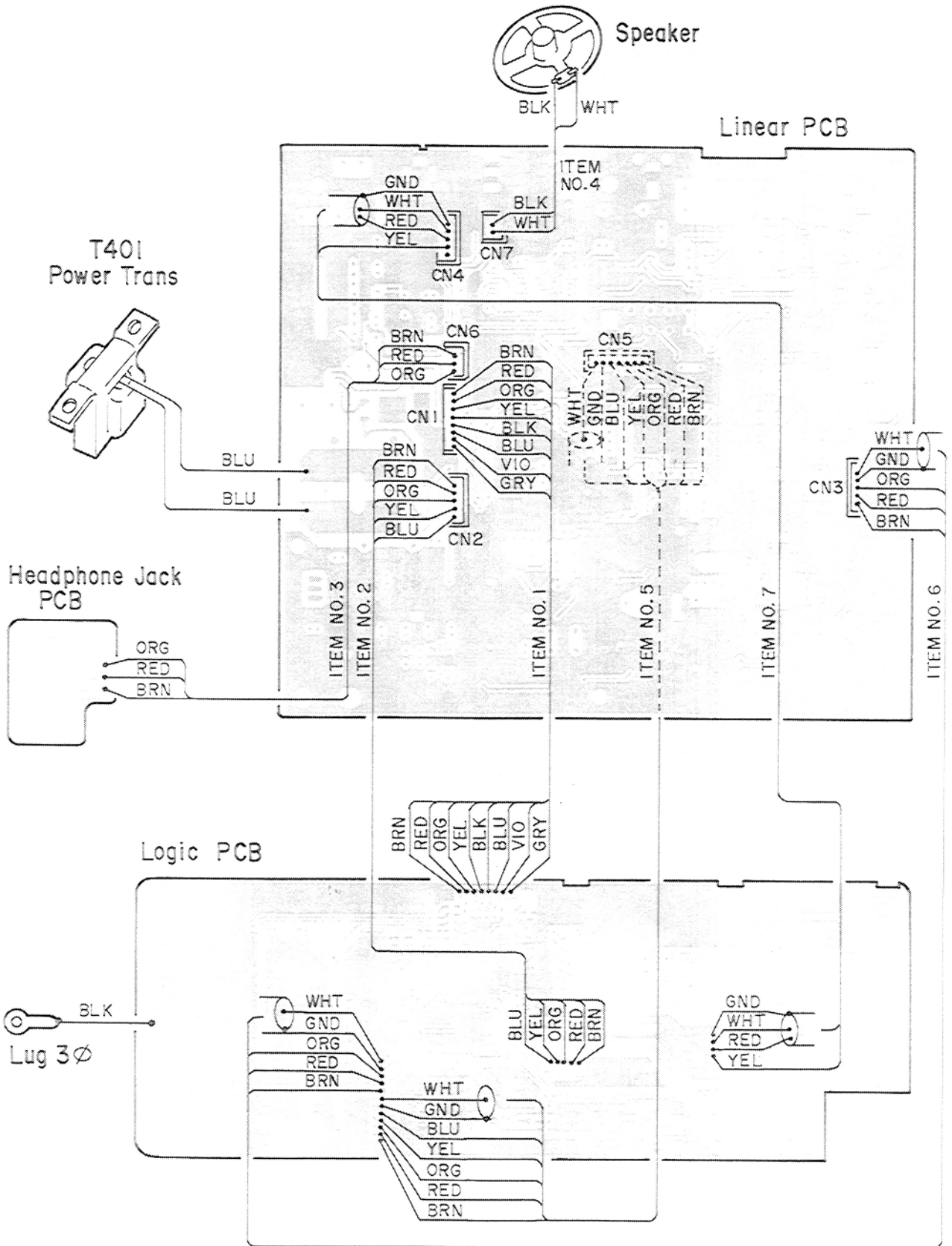

EXPLODED VIEW

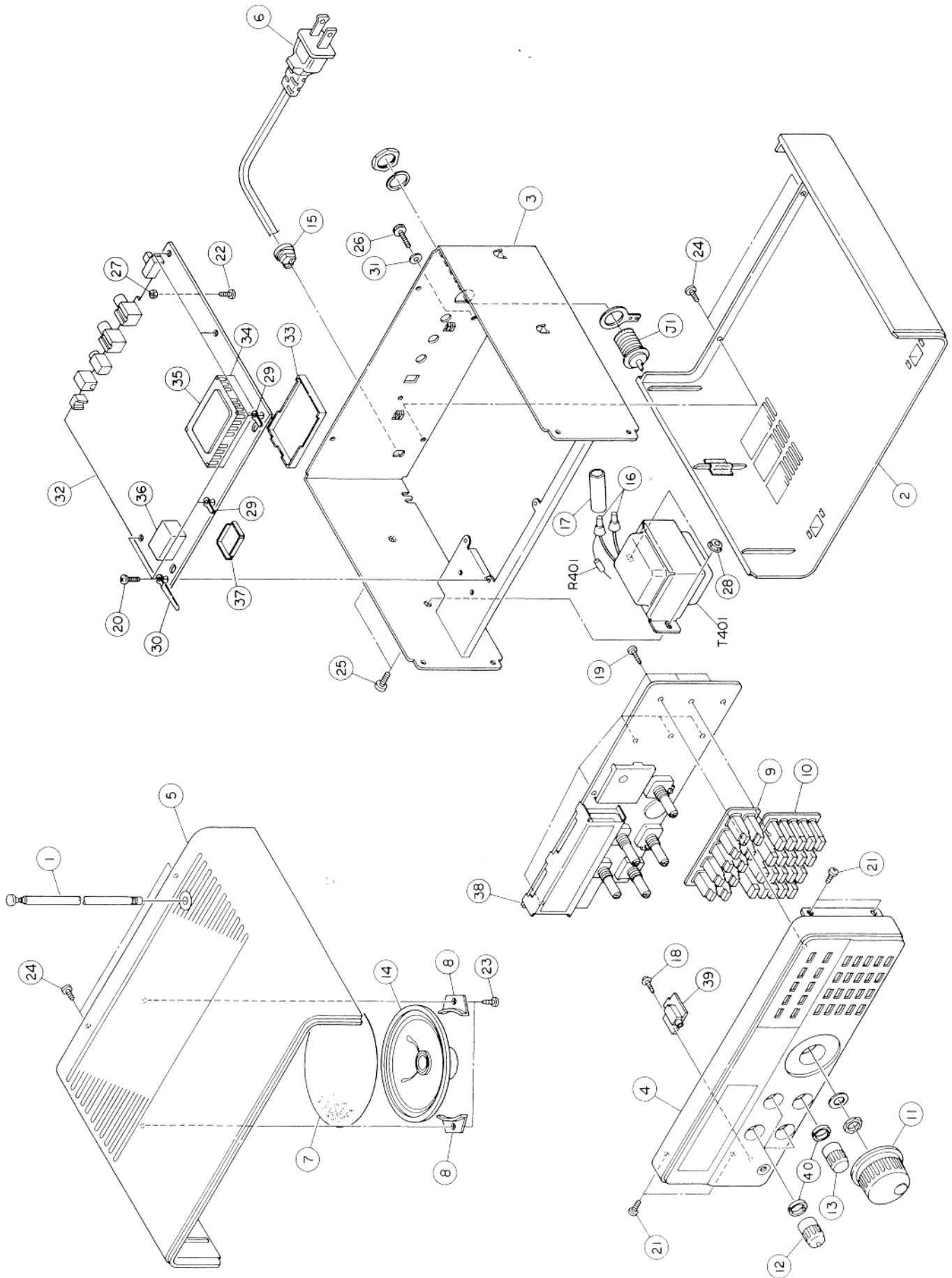

MECHANICAL PARTS LIST

Ref. No.	Description	RS Part No.	Mfr's Part No.
1	Antenna, Telescopic		GE-88D-7597
2	Assembly, Cabinet Bottom (Non-Repairable)		GA-94D-0999
	Cabinet, Bottom		GE-93A-0695
	Foot, Front		GE-88D-7605B
	Tip, Foot		GE-88D-7606
	Foot, Rubber		SJ-5027
	Cushion		GE-91D-9472
3	Assembly, Chassis (Non-Repairable)		GA-95D-1479
	Chassis		GE-94A-1274
	Label, Model		GE-95D-1358-1 or GE-95D-1359-1
4	Assembly, Escutcheon Front (Non-Repairable)		GA-95D-1465
	Escutcheon, Front		GE-94A-1265
	Window		GE-94C-1266
	Tape, Adhesive		GE-95D-1410
5	Cabinet, Top		GE-93A-0694
6	Cord, AC		UP-953-J01
7	Himelon, Speaker		GE-88D-7681
8	Holder, Speaker		GE-84D-4580
J1	Jack, Antenna (Low-Impedance)		010-0062
9	Key Top 10 Key		GE-94C-1269
10	Key Top 20 Key		GE-94C-1270
11	Knob, Tuning		GE-94D-1268
12	Knob, VOL/RF		GE-94D-1267
13	Knob, Fine		GE-94D-1282
R401	Resistor, Solid 1.8 Mohm 1/2 W ±5%		ERC12GK185
14	Speaker		S08J18B
15	Strain Relief, Line Cord		SR-3P-4
16	Terminal		1-SD
T401	Transformer, Power		GE-84D-5158
17	Tube, AH-3		AWG6/16,40 mm/Unit
	Binder, Cord AC		No. 5121 or W-140
	Cushion		GE-91D-9472
	Wire Kit		No. 9351(A)
	Hardware Kit		No. 9351(B)
18	Screw, 2x6 TP Tapping		TP 2x6
19	Screw, 2.6x8 Pan Head P Tight		P tight 2.6x8
20	Screw, 3x8 Blazer Head Tapping		BT 3x8
21	Screw, 3x6 Countersunk Head Machine (Small Type)		CM 3x6
22	Screw, 3x8 Pan Head Machine		PM 3x8
23	Screw, 3x8 Pan Head P Tight		P tight 3x8
24	Screw, 3x8 Binding Head Machine BLK Ni		BM 3x8(BLK)(Ni)
25	Screw, 4x8 Special Binding Head Machine		SBM 4x8
26	Screw, Ground		3x10
27	Nut,		3 mm Dia.
28	Nut, Flange		4 mm Dia.
29	Lug		3 mm Dia.
30	Lug		3 mm Dia. x 27L
31	Washer		3x8x0.5

ELECTRICAL PARTS LIST

LINEAR PCB ASSEMBLY

Ref. No.	Description	RS Part No.	Mfr's Part No.
32	PCB Assembly, Linear Consists of the following:		GA-95D-1463
Capacitors			
C1	Ceramic 100 pF 50 V ±10%		GRM40CH101K50PB or CM21CH101K50A or ECUX1H101KCG or ECUX1H101JCG
C2	Ceramic 39 pF 50 V ±10%		GRM40CH390K50PB or CM21CH390K50A or ECUX1H390KCG or ECUX1H390JCG
C3	Ceramic 100 pF 50 V ±10%		GRM40CH101K50PB or CM21CH101K50A or ECUX1H101KCG or ECUX1H101JCG
C4	Ceramic 39 pF 50 V ±10%		GRM40CH390K50PB or CM21CH390K50A or ECUX1H390KCG or ECUX1H390JCG
C5	Ceramic 100 pF 50 V ±10%		GRM40CH101K50PB or CM21CH101K50A or ECUX1H101KCG or ECUX1H101JCG
C6	Not used		
C7	Ceramic 0.022 μF 50 V ±20%		GRM40B223M50PB or CM21W5R223M50A or ECUX1H223MBX or ECUX1H223KBX
C8	Ceramic 0.022 μF 50 V ±20%		GRM40B223M50PB or CM21W5R223M50A or ECUX1H223MBX or ECUX1H223KBX
C9	Ceramic 0.022 μF 50 V ±20%		GRM40B223M50PB or CM21W5R223M50A or ECUX1H223MBX or ECUX1H223KBX
C10	Ceramic 0.022 μF 50 V ±20%		GRM40B223M50PB or CM21W5R223M50A or ECUX1H223MBX or ECUX1H223KBX
C11	Ceramic 0.022 μF 50 V ±20%		GRM40B223M50PB or CM21W5R223M50A or ECUX1H223MBX or ECUX1H223KBX
C12	Ceramic 0.022 μF 50 V ±20%		GRM40B223M50PB or CM21W5R223M50A or ECUX1H223MBX or ECUX1H223KBX
C13	Ceramic 0.022 μF 50 V ±20%		GRM40B223M50PB or CM21W5R223M50A or ECUX1H223MBX or ECUX1H223KBX

Ref. No.	Description				RS Part No.	Mfr's Part No.
C14	Ceramic	0.022 μ F	50 V	$\pm 20\%$		GRM40B223M50PB or CM21W5R223M50A or ECUX1H223MBX or ECUX1H223KBX
C15	Ceramic	0.022 μ F	50 V	$\pm 10\%$ $\pm 20\%$		GRM40B223M50PB or CM21W5R223M50A or ECUX1H223MBX or ECUX1H223KBX
C16	Ceramic	0.022 μ F	50 V	$\pm 10\%$ $\pm 20\%$		GRM40B223M50PB or CM21W5R223M50A or ECUX1H223MBX or ECUX1H223KBX
C17	Ceramic	0.1 μ F	25 V	$\pm 10\%$ $\pm 10\%$ or +80%-20%		GRM40F104K25PB or CM21Y5V104Z25A or ECUX1E104ZFX
C18	Ceramic	0.022 μ F	50 V	$\pm 20\%$		GRM40B223M50PB or CM21W5R223M50A or ECUX1H223MBX or ECUX1H223KBX
C19	Ceramic	0.022 μ F	50 V	$\pm 10\%$ $\pm 20\%$		GRM40B223M50PB or CM21W5R223M50A or ECUX1H223MBX or ECUX1H223KBX
C20	Ceramic	0.047 μ F	25 V	$\pm 10\%$ $\pm 20\%$		GRM40B473M25PB or CM21W5R473M25A or ECUX1E473KBX
C21	Ceramic	0.047 μ F	25 V	or $\pm 10\%$ $\pm 20\%$		GRM40B473M25PB or CM21W5R473M25A or ECUX1E473KBX
C22	Ceramic	0.1 μ F	25 V	or $\pm 10\%$ $\pm 10\%$ or +80%-20%		GRM40F104K25PB or CM21Y5V104Z25A or ECUX1E104ZFX
C23	Ceramic	0.1 μ F	25 V	$\pm 10\%$ or +80%-20%		GRM40F104K25PB or CM21Y5V104Z25A or ECUX1E104ZFX
C24	Ceramic	0.022 μ F	50 V	$\pm 20\%$		GRM40B223M50PB or CM21W5R223M50A or ECUX1H223MBX or ECUX1H223KBX
C25	Ceramic	0.022 μ F	50 V	$\pm 10\%$ $\pm 20\%$		GRM40B223M50PB or CM21W5R223M50A or ECUX1H223MBX or ECUX1H223KBX
C26	Ceramic	0.022 μ F	50 V	$\pm 10\%$ $\pm 20\%$		GRM40B223M50PB or CM21W5R223M50A or ECUX1H223MBX or ECUX1H223KBX
C27	Ceramic	0.1 μ F	25 V	$\pm 10\%$ $\pm 10\%$ or +80%-20%		GRM40F104K25PB or CM21Y5V104Z25A or ECUX1E104ZFX
C28	Ceramic	0.001 μ F	50 V	$\pm 10\%$		GRM40B102K50PB or CM21W5R102K50A or ECUX1H102KBN
C29	Ceramic	0.1 μ F	25 V	$\pm 10\%$ or +80%-20%		GRM40F104K25PB or CM21Y5V104Z25A or ECUX1E104ZFX

Ref. No.	Description				RS Part No.	Mfr's Part No.
C30	Ceramic	0.1 μ F	25 V	$\pm 10\%$ or +80%-20%		GRM40F104K25PB or CM21Y5V104Z25A or ECUX1E104ZFX
C31	Ceramic	0.022 μ F	50 V	$\pm 20\%$		GRM40B223M50PB or CM21W5R223M50A or ECUX1H223MBX or ECUX1H223KBX
C32	Ceramic	0.1 μ F	25 V	$\pm 10\%$ $\pm 10\%$ or +80%-20%		GRM40F104K25PB or CM21Y5V104Z25A or ECUX1E104ZFX
C33	Ceramic	0.022 μ F	50 V	$\pm 20\%$		GRM40B223M50PB or CM21W5R223M50A or ECUX1H223MBX or ECUX1H223KBX
C34	Electrolytic	1 μ F	50 V	$\pm 10\%$ $\pm 20\%$		50UTSS010 or SM50V010M or UVX1H010MDA
C35	Ceramic	0.022 μ F	50 V	$\pm 20\%$		GRM40B223M50PB or CM21W5R223M50A or ECUX1H223MBX or ECUX1H223KBX
C36	Ceramic	0.022 μ F	50 V	$\pm 10\%$ $\pm 20\%$		GRM40B223M50PB or CM21W5R223M50A or ECUX1H223MBX or ECUX1H223KBX
C37	Ceramic	0.1 μ F	25 V	$\pm 10\%$ $\pm 10\%$ or +80%-20%		GRM40F104K25PB or CM21Y5V104Z25A or ECUX1E104ZFX
C38	Ceramic	0.022 μ F	50 V	$\pm 20\%$		GRM40B223M50PB or CM21W5R223M50A or ECUX1H223MBX or ECUX1H223KBX
C39	Ceramic	0.022 μ F	50 V	$\pm 10\%$ $\pm 20\%$		GRM40B223M50PB or CM21W5R223M50A or ECUX1H223MBX or ECUX1H223KBX
C40	Ceramic	22 pF	50 V	$\pm 10\%$ $\pm 10\%$		GRM40CH220K50PB or CM21CH220K50A or ECUX1H220KCN or ECUX1H220JCN
C41	Not used			$\pm 5\%$		
C42	Ceramic	0.022 μ F	50 V	$\pm 20\%$		GRM40B223M50PB or CM21W5R223M50A or ECUX1H223MBX or ECUX1H223KBX
C43	Ceramic	100 pF	50 V	$\pm 10\%$ $\pm 10\%$		GRM40CH101K50PB or CM21CH101K50A or ECUX1H101KCG or ECUX1H101JCG
C44	Ceramic	100 pF	50 V	$\pm 5\%$ $\pm 10\%$		GRM40CH101K50PB or CM21CH101K50A or ECUX1H101KCG or ECUX1H101JCG
C45	Ceramic	0.022 μ F	50 V	$\pm 5\%$ $\pm 20\%$ $\pm 10\%$		GRM40B223M50PB or CM21W5R223M50A or ECUX1H223MBX or ECUX1H223KBX

Ref. No.	Description				RS Part No.	Mfr's Part No.
C46	Ceramic	0.022 μ F	50 V	$\pm 20\%$		GRM40B223M50PB or CM21W5R223M50A or ECUX1H223MBX or ECUX1H223KBX
C47	Ceramic	0.022 μ F	50 V	$\pm 10\%$ $\pm 20\%$		GRM40B223M50PB or CM21W5R223M50A or ECUX1H223MBX or ECUX1H223KBX
C48	Ceramic	22 pF	50 V	$\pm 10\%$ $\pm 10\%$		GRM40CH220K50PB or CM21CH220K50A or ECUX1H220KCN or ECUX1H220JCN
C49	Ceramic	22 pF	50 V	$\pm 5\%$ $\pm 10\%$		GRM40CH220K50PB or CM21CH220K50A or ECUX1H220KCN or ECUX1H220JCN
C50	Ceramic	22 pF	50 V	$\pm 5\%$ $\pm 10\%$		GRM40CH220K50PB or CM21CH220K50A or ECUX1H220KCN or ECUX1H220JCN
C51	Ceramic	0.047 μ F	25 V	$\pm 5\%$ $\pm 20\%$		GRM40B473M25PB or CM21W5R473M25A or ECUX1E473KBX
C52	Ceramic	0.022 μ F	50 V	or $\pm 10\%$ $\pm 20\%$		GRM40B223M50PB or CM21W5R223M50A or ECUX1H223MBX or ECUX1H223KBX
C53	Ceramic	0.047 μ F	25 V	$\pm 10\%$ $\pm 20\%$		GRM40B473M25PB or CM21W5R473M25A or ECUX1E473KBX
C54	Ceramic	0.047 μ F	25 V	or $\pm 10\%$ $\pm 20\%$		GRM40B473M25PB or CM21W5R473M25A or ECUX1E473KBX
C55	Ceramic	0.1 μ F	25 V	or $\pm 10\%$ $\pm 10\%$ or +80%-20%		GRM40F104K25PB or CM21Y5V104Z25A or ECUX1E104ZFX
C56	Ceramic	0.1 μ F	25 V	$\pm 10\%$ or +80%-20%		GRM40F104K25PB or CM21Y5V104Z25A or ECUX1E104ZFX
C57	Ceramic	0.047 μ F	25 V	$\pm 20\%$		GRM40B473M25PB or CM21W5R473M25A or ECUX1E473KBX
C58	Ceramic	0.022 μ F	50 V	or $\pm 10\%$ $\pm 20\%$		GRM40B223M50PB or CM21W5R223M50A or ECUX1H223MBX or ECUX1H223KBX
C59	Ceramic	0.047 μ F	25 V	$\pm 10\%$ $\pm 20\%$		GRM40B473M25PB or CM21W5R473M25A or ECUX1E473KBX
C60	Ceramic	0.047 μ F	25 V	or $\pm 10\%$ $\pm 20\%$		GRM40B473M25PB or CM21W5R473M25A or ECUX1E473KBX
C61	Ceramic	0.047 μ F	25 V	or $\pm 10\%$ $\pm 20\%$ or $\pm 10\%$		GRM40B473M25PB or CM21W5R473M25A or ECUX1E473KBX

Ref. No.	Description				RS Part No.	Mfr's Part No.
C62	Ceramic	0.047 μ F	25 V	$\pm 20\%$		GRM40B473M25PB or CM21W5R473M25A or ECUX1E473KBX
C63	Ceramic	0.047 μ F	25 V	$\pm 20\%$ or $\pm 10\%$		GRM40B473M25PB or CM21W5R473M25A or ECUX1E473KBX
C64	Ceramic	100 pF	50 V	$\pm 10\%$ or $\pm 10\%$		GRM40CH101K50PB or CM21CH101K50A or ECUX1H101KCG or ECUX1H101JCG
C65	Ceramic	100 pF	50 V	$\pm 10\%$ or $\pm 5\%$		GRM40CH101K50PB or CM21CH101K50A or ECUX1H101KCG or ECUX1H101JCG
C66	Ceramic	0.0033 μ F	50 V	$\pm 10\%$ or $\pm 5\%$		GRM40B332K50PB or CM21W5R332K50A or ECUX1H332KBN
C67	Ceramic	0.022 μ F	50 V	$\pm 20\%$ or $\pm 10\%$		GRM40B223M50PB or CM21W5R223M50A or ECUX1H223MBX or ECUX1H223KBX
C68	Ceramic	0.01 μ F	50 V	$\pm 10\%$ or $\pm 10\%$		GRM40B103K50PB or CM21W5R103K50A or ECUX1H103KGB
C69	Electrolytic	4.7 μ F	50 V	$\pm 20\%$		50UTSS4R7 or SM50V4R7M or UVX1H4R7MDA
C70	Ceramic	0.022 μ F	50 V	$\pm 20\%$ or $\pm 10\%$		GRM40B223M50PB or CM21W5R223M50A or ECUX1H223MBX or ECUX1H223KBX
C71	Electrolytic	1 μ F	50 V	$\pm 20\%$ or $\pm 10\%$		50UTSS010 or SM50V010M or UVX1H010MDA
C72	Ceramic	0.0033 μ F	50 V	$\pm 10\%$		GRM40B332K50PB or CM21W5R332K50A or ECUX1H332KBN
C73	Ceramic	0.022 μ F	50 V	$\pm 20\%$ or $\pm 10\%$		GRM40B223M50PB or CM21W5R223M50A or ECUX1H223MBX or ECUX1H223KBX
C74	Ceramic	0.022 μ F	50 V	$\pm 20\%$ or $\pm 10\%$		GRM40B223M50PB or CM21W5R223M50A or ECUX1H223MBX or ECUX1H223KBX
C75	Electrolytic	10 μ F	16 V	$\pm 20\%$ or $\pm 10\%$		16UTSS100 or SM16V100M or UVX1C100MDA
C76	Ceramic	0.001 μ F	50 V	$\pm 10\%$		GRM40B102K50PB or CM21W5R102K50A or ECUX1H102KBN
C77	Ceramic	22 pF	50 V	$\pm 10\%$ or $\pm 5\%$		GRM40CH220K50PB or CM21CH220K50A or ECUX1H220KCN or ECUX1H220JCN

Ref. No.	Description				RS Part No.	Mfr's Part No.
C78	Ceramic	0.001 μ F	50 V	$\pm 10\%$		GRM40B102K50PB or CM21W5R102K50A or ECUX1H102KBN
C79	Ceramic	22 pF	50 V	$\pm 10\%$		GRM40CH220K50PB or CM21CH220K50A or ECUX1H220KCN or ECUX1H220JCN
C80	Ceramic	0.001 μ F	50 V	$\pm 5\%$ $\pm 10\%$		GRM40B102K50PB or CM21W5R102K50A or ECUX1H102KBN
C81	Ceramic	0.01 μ F	50 V	$\pm 10\%$		GRM40G103K50PB or CM21W5R103K50A or ECUX1H103KGB
C82	Not Used					
C83	Ceramic	0.022 μ F	50 V	$\pm 20\%$		GRM40B223M50PB or CM21W5R223M50A or ECUX1H223MBX or ECUX1H223KBX
C84	Ceramic	0.022 μ F	50 V	$\pm 10\%$ $\pm 20\%$		GRM40B223M50PB or CM21W5R223M50A or ECUX1H223MBX or ECUX1H223KBX
C85	Ceramic	0.022 μ F	50 V	$\pm 10\%$ $\pm 20\%$		GRM40B223M50PB or CM21W5R223M50A or ECUX1H223MBX or ECUX1H223KBX
C86	Electrolytic	10 μ F	16 V	$\pm 10\%$ $\pm 20\%$		16UTSS100 or SM16V100M or UVX1C100MDA
C87	Ceramic	0.001 μ F	50 V	$\pm 10\%$		GRM40B102K50PB or CM21W5R102K50A or ECUX1H102KBN
C88	Ceramic	0.001 μ F	50 V	$\pm 10\%$		GRM40B102K50PB or CM21W5R102K50A or ECUX1H102KBN
C89	Ceramic	270 pF	50 V	$\pm 10\%$		GRM40CH271K50PB or CM21CH271K50A or ECUX1H271KCG or ECUX1H271JCG
C90	Ceramic	100 pF	50 V	$\pm 5\%$ $\pm 10\%$		GRM40CH101K50PB or CM21CH101K50A or ECUX1H101KCG or ECUX1H101JCG
C91	Ceramic	0.022 μ F	50 V	$\pm 5\%$ $\pm 20\%$		GRM40B223M50PB or CM21W5R223M50A or ECUX1H223MBX or ECUX1H223KBX
C92	Ceramic	0.1 μ F	25 V	$\pm 10\%$ $\pm 10\%$ or +80%-20%		GRM40F104K25PB or CM21Y5V104Z25A or ECUX1E104ZFX
C93	Electrolytic	1 μ F	50 V	$\pm 20\%$		50UTSS010 or SM50V010M or UVX1H010MDA
C94	Ceramic	0.047 μ F	25 V	$\pm 20\%$ or $\pm 10\%$		GRM40B473M25PB or CM21W5R473M25A or ECUX1E473KBX

Ref. No.	Description				RS Part No.	Mfr's Part No.
C95	Ceramic	220 pF	50 V	±10%		GRM40CH221K50PB or CM21CH221K50A or ECUX1H221KCG or ECUX1H221JCG
C96	Ceramic	220 pF	50 V	±5% ±10%		GRM40CH221K50PB or CM21CH221K50A or ECUX1H221KCG or ECUX1H221JCG
C97	Ceramic	0.022 μF	50 V	±5% ±20%		GRM40B223M50PB or CM21W5R223M50A or ECUX1H223MBX or ECUX1H223KBX
C98	Ceramic	39 pF	50 V	±10% ±10%		GRM40CH390K50PB or CM21CH390K50A or ECUX1H390KCG or ECUX1H390JCG
C99	Ceramic	0.047 μF	25 V	±5% ±20%		GRM40B473M25PB or CM21W5R473M25A or ECUX1E473KBX
C100	Ceramic	0.0047 μF	25 V	or ±10% ±10%		GRM40B472K25PB or CM21W5R472K25A or ECUX1H472KBG
C101	Ceramic	0.022 μF	50 V or 50 V	±20%		GRM40B223M50PB or CM21W5R223M50A or ECUX1H223MBX or ECUX1H223KBX
C102	Ceramic	0.022 μF	50 V	±10% ±20%		GRM40B223M50PB or CM21W5R223M50A or ECUX1H223MBX or ECUX1H223KBX
C103	Electrolytic	10 μF	16 V	±10% ±20%		16UTSS100 or SM16V100M or UVX1C100MDA
C104	Ceramic	0.047 μF	25 V	±20% or ±10%		GRM40B473M25PB or CM21W5R473M25A or ECUX1E473KBX
C105	Not used					
C106	Not used					
C107	Ceramic	8 pF	50 V	±0.5 pF		GRM40CH080D50PB or CM21CH080D50A or ECUX1H080DCN
C108	Ceramic	4 pF	50 V	±0.25 pF		GRM40CH040C50PB or CM21CH040C50A or ECUX1H040CCN
C109	Ceramic	1 pF	50 V	±0.25 pF		GRM40CH010C50PB or CM21CK010C50A or ECUX1H010CCN
C110	Ceramic	1 pF	50 V	±0.25 pF		GRM40CH010C50PB or CM21CK010C50A or ECUX1H010CCN
C111	Ceramic	100 pF	50 V	±10% ±5%		GRM40CH101K50PB or CM21CH101K50A or ECUX1H101KCG or ECUX1H101JCG

Ref. No.	Description				RS Part No.	Mfr's Part No.
C112	Ceramic	15 pF	50 V	±10%		GRM40CH150K50PB or CM21CH150K50A or ECUX1H150KCN or ECUX1H150JCN
C113	Ceramic	0.001 μF	50 V	±5% ±10%		GRM40B102K50PB or CM21W5R102K50A or ECUX1H102KBN
C114	Ceramic	47 pF	50 V	±10%		GRM40CH470K50PB or CM21CH470K50A or ECUX1H470KCG or ECUX1H470JCG
C115	Ceramic	0.001 μF	50 V	±5% ±10%		GRM40B102K50PB or CM21W5R102K50A or ECUX1H102KBN
C116	Ceramic	0.1 μF	25 V	±10% or +80%-20%		GRM40F104K25PB or CM21Y5V104Z25A or ECUX1E104ZFX
C117	Ceramic	100 pF	50 V	±10%		GRM40CH101K50PB or CM21CH101K50A or ECUX1H101KCG or ECUX1H101JCG
C118	Ceramic	10 pF	50 V	±5% ±0.5 pF		GRM40CH100D50PB or CM21CH100D50A or ECUX1H100DCN
C119	Ceramic	0.022 μF	50 V	±20%		GRM40B223M50PB or CM21W5R223M50A or ECUX1H223MBX or ECUX1H223KBX
C120	Ceramic	27 pF	50 V	±10% ±10%		GRM40CH270K50PB or CM21CH270K50A or ECUX1H270KCG or ECUX1H270JCG
C121	Ceramic	27 pF	50 V	±5% ±10%		GRM40CH270K50PB or CM21CH270K50A or ECUX1H270KCG or ECUX1H270JCG
C122	Ceramic	0.001 μF	50 V	±5% ±10%		GRM40B102K50PB or CM21W5R102K50A or ECUX1H102KBN
C123	Ceramic	0.022 μF	50 V	±20%		GRM40B223M50PB or CM21W5R223M50A or ECUX1H223MBX or ECUX1H223KBX
C124	Electrolytic	10 μF	16 V	±10% ±20%		16UTSS100 or SM16V100M or UVX1C100MDA
C125	Mylar*	0.033 μF	50 V	±10%		AMCS50K333
C126	Mylar	0.047 μF	50 V	±10%		AMCS50K473
C127	Mylar	0.01 μF	50 V	±10%		AMCS50K103
C128	Ceramic	0.001 μF	50 V	±10%		GRM40B102K50PB or CM21W5R102K50A or ECUX1H102KBN
C129	Ceramic	0.022 μF	50 V	±20% ±10%		GRM40B223M50PB or CM21W5R223M50A or ECUX1H223MBX or ECUX1H223KBX

*Mylar is a registered trademark of E.I. DuPont de Nemours and Company.

Ref. No.	Description				RS Part No.	Mfr's Part No.
C130	Ceramic	0.022 μ F	50 V	$\pm 20\%$		GRM40B223M50PB or CM21W5R223M50A or ECUX1H223MBX or ECUX1H223KBX
C131	Electrolytic	1 μ F	50 V	$\pm 10\%$ $\pm 20\%$		50UTSS010 or SM50V010M or UVX1H010MDA
C132	Ceramic	0.022 μ F	50 V	$\pm 20\%$		GRM40B223M50PB or CM21W5R223M50A or ECUX1H223MBX or ECUX1H223KBX
C133	Ceramic	0.0033 μ F	50 V	$\pm 10\%$ $\pm 10\%$		GRM40B332K50PB or CM21W5R332K50A or ECUX1H332KBN
C134	Ceramic	0.022 μ F	50 V	$\pm 20\%$		GRM40B223M50PB or CM21W5R223M50A or ECUX1H223MBX or ECUX1H223KBX
C135	Electrolytic	4.7 μ F	50 V	$\pm 10\%$ $\pm 20\%$		50UTSS4R7 or SM50V4R7M or UVX1H4R7MDA
C136	Electrolytic	33 μ F	16 V	$\pm 20\%$		16UTSS330 or SM16V330M or UVX1C330MDA
C137	Electrolytic	0.22 μ F	50 V	$\pm 20\%$		50UTSSR22 or SM50VR22M or UVX1HR22MDA
C138	Electrolytic	4.7 μ F	50 V	$\pm 20\%$		50UTSS4R7 or SM50V4R7M or UVX1H4R7MDA
C139	Electrolytic	10 μ F	16 V	$\pm 20\%$		16UTSS100 or SM16V100M or UVX1C100MDA
C140	Electrolytic	10 μ F	16 V	$\pm 20\%$		16UTSS100 or SM16V100M or UVX1C100MDA
C141	Ceramic	0.022 μ F	50 V	$\pm 20\%$		GRM40B223M50PB or CM21W5R223M50A or ECUX1H223MBX or ECUX1H223KBX
C142	Ceramic	0.001 μ F	50 V	$\pm 10\%$ $\pm 10\%$		GRM40B102K50PB or CM21W5R102K50A or ECUX1H102KBN
C143	Electrolytic	10 μ F	16 V	$\pm 20\%$		16UTSS100 or SM16V100M or UVX1C100MDA
C144	Electrolytic	2200 μ F	25 V	$\pm 20\%$		25UTSS222 or SM25V222M or UVX1E222MHA
C145	Ceramic	0.022 μ F	50 V	$\pm 20\%$		GRM40B223M50PB or CM21W5R223M50A or ECUX1H223MBX or ECUX1H223KBX
C146	Ceramic	0.022 μ F	50 V	$\pm 10\%$ $\pm 20\%$		GRM40B223M50PB or CM21W5R223M50A or ECUX1H223MBX or ECUX1H223KBX

Ref. No.	Description				RS Part No.	Mfr's Part No.
C147	Ceramic	0.022 μ F	50 V	$\pm 20\%$		GRM40B223M50PB or CM21W5R223M50A or ECUX1H223MBX or ECUX1H223KBX
C148	Ceramic	0.022 μ F	50 V	$\pm 10\%$ $\pm 20\%$		GRM40B223M50PB or CM21W5R223M50A or ECUX1H223MBX or ECUX1H223KBX
C149	Ceramic	0.1 μ F	25 V	$\pm 10\%$ $\pm 10\%$ or +80%-20%		GRM40F104K25PB or CM21Y5V104Z25A or ECUX1E104ZFX
C150	Electrolytic	10 μ F	16 V	$\pm 20\%$		16UTSS100 or SM16V100M or UVX1C100MDA
C151	Electrolytic	10 μ F	16 V	$\pm 20\%$		16UTSS100 or SM16V100M or UVX1C100MDA
C152	Electrolytic	1 μ F	50 V	$\pm 20\%$		50UTSS010 or SM50V010M or UVX1H010MDA
C153	Mylar	0.1 μ F	50 V	$\pm 10\%$		AMCS50K104
C154	Electrolytic	47 μ F	16 V	$\pm 20\%$		16UTSS470 or SM16V470M or UVX1C470MDA
C155	Electrolytic	100 μ F	16 V	$\pm 20\%$		16UTSS101 or SM16V101M or UVX1C101MEA
C156	Ceramic	0.1 μ F	25 V	$\pm 10\%$ or +80%-20%		GRM40F104K25PB or CM21Y5V104Z25A or ECUX1E104ZFX
C157	Electrolytic	1000 μ F	16 V	$\pm 20\%$		SM16V102M or UVX1C102MPA
C158	Not used					
C159	Ceramic	100 pF	50 V	$\pm 10\%$		GRM40CH101K50PB or CM21CH101K50A or ECUX1H101KCN or ECUX1H101JCN
C160	Ceramic	0.1 μ F	25 V	$\pm 5\%$ $\pm 10\%$ or +80%-20%		GRM40F104K25PB or CM21Y5V104Z25A or ECUX1E104ZFX
C161	Electrolytic	1 μ F	50 V	$\pm 20\%$		50UTSS010 or SM50V010M or UVX1H010MDA
C162	Not used					
C163	Ceramic	0.1 μ F	25 V	$\pm 10\%$ or +80%-20%		GRM40F104K25PB or CM21Y5V104Z25A or ECUX1E104ZFX
C164	Ceramic	0.001 μ F	50 V	$\pm 10\%$		GRM40B102K50PB or CM21W5R102K50A or ECUX1H102KBN
C165	Ceramic	0.047 μ F	25 V	$\pm 20\%$ or $\pm 10\%$		GRM40B473M25PB or CM21W5R473M25A or ECUX1E473KBX
C166	Ceramic	0.047 μ F	25 V	$\pm 20\%$		GRM40B473M25PB or CM21W5R473M25A or ECUX1E473KBX
C167	Not used			or $\pm 10\%$		

Ref. No.	Description				RS Part No.	Mfr's Part No.
C168	Not used					
C169	Not used					
C170	Electrolytic	1 μ F	50 V	$\pm 20\%$		50UTSS010 or SM50V010M or UVX1H010MDA
C171	Electrolytic	100 μ F	16 V	$\pm 20\%$		16UTSS01 or SM16V101M or UVX1C101MEA
C172	Ceramic	270 pF	50 V	$\pm 10\%$		GRM40CH271K50PB or CM21CH271K50A or ECUX1H271KCG
C173	Ceramic	68 pF	50 V	$\pm 5\%$ $\pm 10\%$		or ECUX1H271JCG GRM40CH680K50PB or CM21CH680K50A or ECUX1H680KCG
C174	Electrolytic	1 μ F	50 V	$\pm 5\%$ $\pm 20\%$		or ECUX1H680JCG 50UTSS010 or SM50V010M or UVX1H010MDA
C175	Ceramic	100 pF	50 V	$\pm 10\%$		GRM40CH101K50PB or CM21CH101K50A or ECUX1H101KCG
C176	Ceramic	100 pF	50 V	$\pm 5\%$ $\pm 10\%$		or ECUX1H101JCG GRM40CH101K50PB or CM21CH101K50A or ECUX1H101KCG
C177	Ceramic	100 pF	50 V	$\pm 5\%$ $\pm 10\%$		or ECUX1H101JCG GRM40CH101K50PB or CM21CH101K50A or ECUX1H101KCG
C178	Ceramic	7 pF	50 V	$\pm 5\%$ ± 0.5 pF		or ECUX1H101JCG GRM40CH070D50PB or CM21CH070D50A or ECUX1H070DCN
C179	Ceramic	15 pF	50 V	$\pm 10\%$		GRM40CH150K50PB or CM21CH150K50A or ECUX1H150KCN
C180	Ceramic	0.001 μ F	50 V	$\pm 5\%$ $\pm 10\%$		or ECUX1H150JCN GRM40B102K50PB or CM21W5R102K50A or ECUX1H102KBN
C181	Ceramic	10 pF	50 V	± 0.5 pF		GRM40CH100D50PB or CM21CH100D50A or ECUX1H100DCN
C182	Ceramic	0.047 μ F	25 V	$\pm 20\%$		GRM40B473M25PB or CM21W5R473M25A or ECUX1E473KBX
C183	Ceramic	0.001 μ F	50 V	or $\pm 10\%$ $\pm 10\%$		GRM40B102K50PB or CM21W5R102K50A or ECUX1H102KBN

Ref. No.	Description			RS Part No.	Mfr's Part No.
Capacitor Blocks					
CB1	0.01 μ F x 2	250 V	+80%-20%		EXR-FS203ZS
CB2	0.01 μ F x 2	250 V	+80%-20%		EXR-FS203ZS
Ceramic Filters					
CF1	455 kHz				CFWS455HT or CFW455HT or LTW33-455
CF2	455 kHz				CFWS455IT or CFW455IT or LTW33-455IT
Diodes					
D1	1SV172 or HVM14S or DPA05	Marked BE Marked H6 Marked W9	Silicon		1SV172 or HVM14S or DPA05
D2	Not used				
D3	DA227	Marked N20	Silicon		DA227
D4	HSU277	Marked 3	Silicon		HSU277
D5	HSU277	Marked 3	Silicon		HSU277
D6	HSU277	Marked 3	Silicon		HSU277
D7	1SS272	Marked A1	Silicon		1SS272
D8	KV1580 3 or KV1580 4 or KV1580 5	Marked A8	Silicon	Varactor	KV1580 3 or KV1580 4 or 5
D9	HSU277	Marked 3	Silicon		HSU277
D10	HSU277	Marked 3	Silicon		HSU277
D11	HSU277	Marked 3	Silicon		HSU277
D12	HSU277	Marked 3	Silicon		HSU277
D13	HSU277	Marked 3	Silicon		HSU277
D14	1SS272	Marked A1	Silicon		1SS272
D15	1SS272	Marked A1	Silicon		1SS272
D16	1SS272	Marked A1	Silicon		1SS272
D17	DA227	Marked N20	Silicon		DA227
D18	ZSML-7.5(Y)		Silicon	Zener	ZSML-7.5(Y)
D19	HVU17	Marked E	Silicon	Varactor	HVU17
D20	MA724	Marked M1T	Silicon		MA724
D21	MA724	Marked M1T	Silicon		MA724
D22	DA227	Marked N20	Silicon		DA227
D23	Not used				
D24	DA227	Marked N20	Silicon		DA227
D25	DA227	Marked N20	Silicon		DA227
D26	HVU300A	Marked 0	Silicon	Varactor	HVU300A
D27	RC202	Rectifier	Silicon		RC202
D28	1N4002		Silicon		1N4002
D29	ZSML-7.5(Y)		Silicon	Zener	ZSML-7.5(Y)
D30	ZSML-7.5(Y)		Silicon	Zener	ZSML-7.5(Y)
D31	1SS226	Marked C3	Silicon		1SS226
D32	DA227	Marked N20	Silicon		DA227
D33	ZSML-7.5(Y)		Silicon		ZSML-7.5(Y)
D34	ZSML-7.5(Y)		Silicon		ZSML-7.5(Y)

Ref. No.	Description	RS Part No.	Mfr's Part No.
Integrated Circuits			
IC1	MB87014APF-G-BND PLL MOS SMT		MB87014APF-G-BND
IC2	μ PC358G Low-Pass Filter/Band-Pass Filter or NJM2904M Bipolar SMT		μ PC358G or NJM2904M
IC3	TC4066BF Switching MOS SMT		TC4066BF
IC4	TDA1905 Audio Amp Bipolar		TDA1905
IC5	TK11806M DC-DC Converter Bipolar SMT		TK11806M
IC6	TA78L005AP Voltage Regulator Bipolar		TA78L005AP

Coils			
L1	LPF 0.33 μ H		LK2125R33K
L2	LPF 0.33 μ H		LK2125R33K
L3	Choke 10 mH		LHL06NB103J
L4	Not used		
L5	Choke 1 mH		LHL06NB102J
L6	OSC 44.545 MHz		7TSE-360
L7	OSC 44.545 MHz		LK2125R82K
L8	Noise Blanker		7PSI-369
L9	Choke 10 μ H		LK2125100K
L10	OSC 33 MHz		LAL03KH1R0M
L11	OSC 33 MHz		7TSE-360
L12	LPF 0.82 μ H		LK2125R82K
L13	LPF 0.82 μ H		LK2125R82K
L14	VCO		7TSV-366
L15	DC-DC Converter (OSC)		GRD-835
L16	Choke		3B037
L17	Choke 100 μ H		7306-101K
L18	Choke 4.7 μ H		LK21254R7K
L19	Trap		LAL03NA471K
L20	Choke 10 μ H		LAL04SK100K
L21	Choke 2.7 μ H		LK21252R7K
L22	Choke 0.33 μ H		LK2125R33K

Transistors			
Q1	3SK195 Marked UJ	FET MOS	3SK195
Q2	2SC2712(GR) Marked LG or KEC3875S(GR) Marked ALG	NPN	2SC2712(GR) or KEC3875S(GR)
Q3	3SK195 Marked UJ	FET MOS	3SK195
Q4	3SK195 Marked UJ	FET MOS	3SK195
Q5	2SC2714(O) Marked QO	NPN	2SC2714(O)
Q6	2SK210(Y) Marked YY	FET MOS	2SK210(Y)
Q7	2SC2712(Y) Marked LY or KEC3875S(Y) Marked ALY	NPN	2SC2712(Y) or KEC3875S(Y)
Q8	2SC2712(Y) Marked LY or KEC3875S(Y) Marked ALY	NPN	2SC2712(Y) or KEC3875S(Y)
Q9	2SC2712(GR) Marked LG or KEC3875S(GR) Marked ALG	NPN	2SC2712(GR) or KEC3875S(GR)
Q10	2SC2712(GR) Marked LG or KEC3875S(GR) Marked ALG	NPN	2SC2712(GR) or KEC3875S(GR)
Q11	2SA1162(G) Marked SG	PNP	2SA1162(G)
Q12	2SC2714(O) Marked QO	NPN	2SC2714(O)

Ref. No.	Description				RS Part No.	Mfr's Part No.
Q13	2SC2712(GR)	Marked LG		NPN		2SC2712(GR)
	or KEC3875S(GR)		Marked ALG			or KEC3875S(GR)
Q14	2SK209(Y)	Marked XY		FET	MOS	2SK209(Y)
Q15	2SK209(Y)	Marked XY		FET	MOS	2SK209(Y)
Q16	UN5214	Marked 8D			NPN	UN5214
Q17	UN5214	Marked 8D			NPN	UN5214
Q18	2SC2712(GR)	Marked LG			NPN	2SC2712(GR)
	or KEC3875S(GR)		Marked ALG			or KEC3875S(GR)
Q19	2SC2712(GR)	Marked LG			NPN	2SC2712(GR)
	or KEC3875S(GR)		Marked ALG			or KEC3875S(GR)
Q20	2SC2712(Y)	Marked LY			NPN	2SC2712(Y)
	or KEC3875S(Y)		Marked ALY			or KEC3875S(Y)
Q21	UN5111	Marked GA			PNP	UN5111
Q22	UN5214	Marked 8D			NPN	UN5214
Q23	2SC2714(O)	Marked QO			NPN	2SC2714(O)
Q24	2SC2714(O)	Marked QO			NPN	2SC2714(O)
Q25	2SC2712(Y)	Marked LY			NPN	2SC2712(Y)
	or KEC3875S(Y)		Marked ALY			or KEC3875S(Y)
Q26	2SK209(Y)	Marked XY		FET	MOS	2SK209(Y)
Q27	UN5214	Marked 8D			NPN	UN5214
Q28	2SC2712(GR)	Marked LG			NPN	2SC2712(GR)
	or KEC3875S(GR)		Marked ALG			or KEC3875S(GR)
Q29	2SC2712(GR)	Marked LG			NPN	2SC2712(GR)
	or KEC3875S(GR)		Marked ALG			or KEC3875S(GR)
Q30	2SA1241(Y) (LB)	Marked ID			PNP	2SA1241(Y) (LB)
Q31	UN5214	Marked 8D			NPN	UN5214
Q32	2SC2712(GR)	Marked LG			NPN	2SC2712(GR)
	or KEC3875S(GR)		Marked ALG			or KEC3875S(GR)
Q33	2SC2712(GR)	Marked LG			NPN	2SC2712(GR)
	or KEC3875S(GR)		Marked ALG			or KEC3875S(GR)
Q34	2SC2712(GR)	Marked LG			NPN	2SC2712(GR)
	or KEC3875S(GR)		Marked ALG			or KEC3875S(GR)

Resistors

R1	Metal Glaze	39 ohm	1/10 W	±5%		RK73K2A390J or CR21-390J or ERJ6GEYJ390B
R2	Metal Glaze	10 ohm	1/10 W	±5%		RK73K2A100J or CR21-100J or ERJ6GEYJ100B
R3	Metal Glaze	39 ohm	1/10 W	±5%		RK73K2A390J or CR21-390J or ERJ6GEYJ390B
R4	Metal Glaze	1 kohm	1/10 W	±5%		RK73K2A102J or CR21-102J or ERJ6GEYJ102B
R5	Metal Glaze	100 kohm	1/10 W	±5%		RK73K2A104J or CR21-104J or ERJ6GEYJ104B
R6	Metal Glaze	1 kohm	1/10 W	±5%		RK73K2A102J or CR21-102J or ERJ6GEYJ102B
R7	Metal Glaze	1 Mohm	1/10 W	±5%		RK73K2A105J or CR21-105J or ERJ6GEYJ105B
R8	Metal Glaze	100 kohm	1/10 W	±5%		RK73K2A104J or CR21-104J or ERJ6GEYJ104B

Ref. No.	Description				RS Part No.	Mfr's Part No.
R9	Metal Glaze	1 kohm	1/10 W	±5%		RK73K2A102J or CR21-102J or ERJ6GEYJ102B
R10	Metal Glaze	1 Mohm	1/10 W	±5%		RK73K2A105J or CR21-105J or ERJ6GEYJ105B
R11	Metal Glaze	100 kohm	1/10 W	±5%		RK73K2A104J or CR21-104J or ERJ6GEYJ104B
R12	Metal Glaze	1 kohm	1/10 W	±5%		RK73K2A102J or CR21-102J or ERJ6GEYJ102B
R13	Metal Glaze	1 Mohm	1/10 W	±5%		RK73K2A105J or CR21-105J or ERJ6GEYJ105B
R14	Metal Glaze	100 kohm	1/10 W	±5%		RK73K2A104J or CR21-104J or ERJ6GEYJ104B
R15	Metal Glaze	1 kohm	1/10 W	±5%		RK73K2A102J or CR21-102J or ERJ6GEYJ102B
R16	Metal Glaze	1 Mohm	1/10 W	±5%		RK73K2A105J or CR21-105J or ERJ6GEYJ105B
R17	Metal Glaze	100 kohm	1/10 W	±5%		RK73K2A104J or CR21-104J or ERJ6GEYJ104B
R18	Metal Glaze	1 kohm	1/10 W	±5%		RK73K2A102J or CR21-102J or ERJ6GEYJ102B
R19	Metal Glaze	1 Mohm	1/10 W	±5%		RK73K2A105J or CR21-105J or ERJ6GEYJ105B
R20	Metal Glaze	100 ohm	1/10 W	±5%		RK73K2A101J or CR21-101J or ERJ6GEYJ101B
R21	Metal Glaze	47 kohm	1/10 W	±5%		RK73K2A473J or CR21-473J or ERJ6GEYJ473B
R22	Metal Glaze	47 kohm	1/10 W	±5%		RK73K2A473J or CR21-473J or ERJ6GEYJ473B
R23	Metal Glaze	100 kohm	1/10 W	±5%		RK73K2A104J or CR21-104J or ERJ6GEYJ104B
R24	Metal Glaze	1 Mohm	1/10 W	±5%		RK73K2A105J or CR21-105J or ERJ6GEYJ105B
R25	Metal Glaze	1 Mohm	1/10 W	±5%		RK73K2A105J or CR21-105J or ERJ6GEYJ105B
R26	Metal Glaze	1 Mohm	1/10 W	±5%		RK73K2A105J or CR21-105J or ERJ6GEYJ105B
R27	Metal Glaze	1 Mohm	1/10 W	±5%		RK73K2A105J or CR21-105J or ERJ6GEYJ105B

Ref. No.	Description				RS Part No.	Mfr's Part No.
R28	Metal Glaze	1 Mohm	1/10 W	±5%		RK73K2A105J or CR21-105J or ERJ6GEYJ105B
R29	Metal Glaze	1 Mohm	1/10 W	±5%		RK73K2A105J or CR21-105J or ERJ6GEYJ105B
R30	Metal Glaze	1 Mohm	1/10 W	±5%		RK73K2A105J or CR21-105J or ERJ6GEYJ105B
R31	Metal Glaze	1 Mohm	1/10 W	±5%		RK73K2A105J or CR21-105J or ERJ6GEYJ105B
R32	Metal Glaze	150 kohm	1/10 W	±5%		RK73K2A154J or CR21-154J or ERJ6GEYJ154B
R33	Metal Glaze	470 kohm	1/10 W	±5%		RK73K2A474J or CR21-474J or ERJ6GEYJ474B
R34	Metal Glaze	100 kohm	1/10 W	±5%		RK73K2A104J or CR21-104J or ERJ6GEYJ104B
R35	Not used					
R36	Metal Glaze	100 ohm	1/10 W	±5%		RK73K2A101J or CR21-101J or ERJ6GEYJ101B
R37	Metal Glaze	560 ohm	1/10 W	±5%		RK73K2A561J or CR21-561J or ERJ6GEYJ561B
R38	Metal Glaze	100 ohm	1/10 W	±5%		RK73K2A101J or CR21-101J or ERJ6GEYJ101B
R39	Metal Glaze	22 kohm	1/10 W	±5%		RK73K2A223J or CR21-223J or ERJ6GEYJ223B
R40	Metal Glaze	47 kohm	1/10 W	±5%		RK73K2A473J or CR21-473J or ERJ6GEYJ473B
R41	Metal Glaze	220 kohm	1/10 W	±5%		RK73K2A224J or CR21-224J or ERJ6GEYJ224B
R42	Metal Glaze	220 kohm	1/10 W	±5%		RK73K2A224J or CR21-224J or ERJ6GEYJ224B
R43	Metal Glaze	470 kohm	1/10 W	±5%		RK73K2A474J or CR21-474J or ERJ6GEYJ474B
R44	Metal Glaze	100 ohm	1/10 W	±5%		RK73K2A101J or CR21-101J or ERJ6GEYJ101B
R45	Metal Glaze	47 kohm	1/10 W	±5%		RK73K2A473J or CR21-473J or ERJ6GEYJ473B
R46	Metal Glaze	1 kohm	1/10 W	±5%		RK73K2A102J or CR21-102J or ERJ6GEYJ102B

Ref. No.	Description				RS Part No.	Mfr's Part No.
R47	Metal Glaze	1 kohm	1/10 W	±5%		RK73K2A102J or CR21-102J or ERJ6GEYJ102B
R48	Not used					
R49	Metal Glaze	100 ohm	1/10 W	±5%		RK73K2A101J or CR21-101J or ERJ6GEYJ101B
R50	Metal Glaze	10 kohm	1/10 W	±5%		RK73K2A103J or CR21-103J or ERJ6GEYJ103B
R51	Metal Glaze	10 kohm	1/10 W	±5%		RK73K2A103J or CR21-103J or ERJ6GEYJ103B
R52	Metal Glaze	100 ohm	1/10 W	±5%		RK73K2A101J or CR21-101J or ERJ6GEYJ101B
R53	Metal Glaze	10 kohm	1/10 W	±5%		RK73K2A103J or CR21-103J or ERJ6GEYJ103B
R54	Metal Glaze	100 ohm	1/10 W	±5%		RK73K2A101J or CR21-101J or ERJ6GEYJ101B
R55	Metal Glaze	22 kohm	1/10 W	±5%		RK73K2A223J or CR21-223J or ERJ6GEYJ223B
R56	Metal Glaze	4.7 kohm	1/10 W	±5%		RK73K2A472J or CR21-472J or ERJ6GEYJ472B
R57	Metal Glaze	4.7 kohm	1/10 W	±5%		RK73K2A472J or CR21-472J or ERJ6GEYJ472B
R58	Metal Glaze	1 kohm	1/10 W	±5%		RK73K2A102J or CR21-102J or ERJ6GEYJ102B
R59	Metal Glaze	1 kohm	1/10 W	±5%		RK73K2A102J or CR21-102J or ERJ6GEYJ102B
R60	Metal Glaze	2.2 kohm	1/10 W	±5%		RK73K2A222J or CR21-222J or ERJ6GEYJ222B
R61	Metal Glaze	2.2 kohm	1/10 W	±5%		RK73K2A222J or CR21-222J or ERJ6GEYJ222B
R62	Metal Glaze	2.2 kohm	1/10 W	±5%		RK73K2A222J or CR21-222J or ERJ6GEYJ222B
R63	Metal Glaze	22 kohm	1/10 W	±5%		RK73K2A223J or CR21-223J or ERJ6GEYJ223B
R64	Metal Glaze	2.2 kohm	1/10 W	±5%		RK73K2A222J or CR21-222J or ERJ6GEYJ222B
R65	Metal Glaze	47 kohm	1/10 W	±5%		RK73K2A473J or CR21-473J or ERJ6GEYJ473B

Ref. No.	Description				RS Part No.	Mfr's Part No.
R66	Metal Glaze	1 kohm	1/10 W	±5%		RK73K2A102J or CR21-102J or ERJ6GEYJ102B
R67	Metal Glaze	82 kohm	1/10 W	±5%		RK73K2A823J or CR21-823J or ERJ6GEYJ823B
R68	Metal Glaze	100 ohm	1/10 W	±5%		RK73K2A101J or CR21-101J or ERJ6GEYJ101B
R69	Metal Glaze	47 kohm	1/10 W	±5%		RK73K2A473J or CR21-473J or ERJ6GEYJ473B
R70	Metal Glaze	10 kohm	1/10 W	±5%		RK73K2A103J or CR21-103J or ERJ6GEYJ103B
R71	Metal Glaze	470 ohm	1/10 W	±5%		RK73K2A471J or CR21-471J or ERJ6GEYJ471B
R72	Metal Glaze	470 ohm	1/10 W	±5%		RK73K2A471J or CR21-471J or ERJ6GEYJ471B
R73	Metal Glaze	100 ohm	1/10 W	±5%		RK73K2A101J or CR21-101J or ERJ6GEYJ101B
R74	Metal Glaze	100 kohm	1/10 W	±5%		RK73K2A104J or CR21-104J or ERJ6GEYJ104B
R75	Metal Glaze	1 Mohm	1/10 W	±5%		RK73K2A105J or CR21-105J or ERJ6GEYJ105B
R76	Metal Glaze	47 kohm	1/10 W	±5%		RK73K2A473J or CR21-473J or ERJ6GEYJ473B
R77	Metal Glaze	22 kohm	1/10 W	±5%		RK73K2A223J or CR21-223J or ERJ6GEYJ223B
R78	Metal Glaze	3.3 kohm	1/10 W	±5%		RK73K2A332J or CR21-332J or ERJ6GEYJ332B
R79	Metal Glaze	4.7 kohm	1/10 W	±5%		RK73K2A472J or CR21-472J or ERJ6GEYJ472B
R80	Metal Glaze	10 kohm	1/10 W	±5%		RK73K2A103J or CR21-103J or ERJ6GEYJ103B
R81	Metal Glaze	33 kohm	1/10 W	±5%		RK73K2A333J or CR21-333J or ERJ6GEYJ333B
R82	Metal Glaze	33 kohm	1/10 W	±5%		RK73K2A333J or CR21-333J or ERJ6GEYJ333B
R83	Metal Glaze	1 kohm	1/10 W	±5%		RK73K2A102J or CR21-102J or ERJ6GEYJ102B
R84	Metal Glaze	47 kohm	1/10 W	±5%		RK73K2A473J or CR21-473J or ERJ6GEYJ473B

Ref. No.	Description				RS Part No.	Mfr's Part No.
R85	Metal Glaze	10 kohm	1/10 W	±5%		RK73K2A103J or CR21-103J or ERJ6GEYJ103B
R86	Metal Glaze	22 kohm	1/10 W	±5%		RK73K2A223J or CR21-223J or ERJ6GEYJ223B
R87	Metal Glaze	15 kohm	1/10 W	±5%		RK73K2A153J or CR21-153J or ERJ6GEYJ153B
R88	Metal Glaze	1 kohm	1/10 W	±5%		RK73K2A102J or CR21-102J or ERJ6GEYJ102B
R89	Metal Glaze	10 kohm	1/10 W	±5%		RK73K2A103J or CR21-103J or ERJ6GEYJ103B
R90	Metal Glaze	22 kohm	1/10 W	±5%		RK73K2A223J or CR21-223J or ERJ6GEYJ223B
R91	Metal Glaze	1 kohm	1/10 W	±5%		RK73K2A102J or CR21-102J or ERJ6GEYJ102B
R92	Metal Glaze	100 ohm	1/10 W	±5%		RK73K2A101J or CR21-101J or ERJ6GEYJ101B
R93	Metal Glaze	1 Mohm	1/10 W	±5%		RK73K2A105J or CR21-105J or ERJ6GEYJ105B
R94	Metal Glaze	1 Mohm	1/10 W	±5%		RK73K2A105J or CR21-105J or ERJ6GEYJ105B
R95	Metal Glaze	100 kohm	1/10 W	±5%		RK73K2A104J or CR21-104J or ERJ6GEYJ104B
R96	Metal Glaze	1 Mohm	1/10 W	±5%		RK73K2A105J or CR21-105J or ERJ6GEYJ105B
R97	Metal Glaze	1 Mohm	1/10 W	±5%		RK73K2A105J or CR21-105J or ERJ6GEYJ105B
R98	Metal Glaze	2.2 kohm	1/10 W	±5%		RK73K2A222J or CR21-222J or ERJ6GEYJ222B
R99	Metal Glaze	1 Mohm	1/10 W	±5%		RK73K2A105J or CR21-105J or ERJ6GEYJ105B
R100	Metal Glaze	1 Mohm	1/10 W	±5%		RK73K2A105J or CR21-105J or ERJ6GEYJ105B
R101	Not used					
R102	Metal Glaze	2.2 kohm	1/10 W	±5%		RK73K2A222J or CR21-222J or ERJ6GEYJ222B
R103	Metal Glaze	1 kohm	1/10 W	±5%		RK73K2A102J or CR21-102J or ERJ6GEYJ102B

Ref. No.	Description				RS Part No.	Mfr's Part No.
R104	Metal Glaze	470 kohm	1/10 W	±5%		RK73K2A474J or CR21-474J or ERJ6GEYJ474B
R105	Metal Glaze	1 kohm	1/10 W	±5%		RK73K2A102J or CR21-102J or ERJ6GEYJ102B
R106	Metal Glaze	10 kohm	1/10 W	±5%		RK73K2A103J or CR21-103J or ERJ6GEYJ103B
R107	Metal Glaze	10 kohm	1/10 W	±5%		RK73K2A103J or CR21-103J or ERJ6GEYJ103B
R108	Metal Glaze	100 kohm	1/10 W	±5%		RK73K2A104J or CR21-104J or ERJ6GEYJ104B
R109	Metal Glaze	1 kohm	1/10 W	±5%		RK73K2A102J or CR21-102J or ERJ6GEYJ102B
R110	Metal Glaze	10 kohm	1/10 W	±5%		RK73K2A103J or CR21-103J or ERJ6GEYJ103B
R111	Metal Glaze	10 kohm	1/10 W	±5%		RK73K2A103J or CR21-103J or ERJ6GEYJ103B
R112	Metal Glaze	330 ohm	1/10 W	±5%		RK73K2A331J or CR21-331J or ERJ6GEYJ331B
R113	Metal Glaze	330 ohm	1/10 W	±5%		RK73K2A331J or CR21-331J or ERJ6GEYJ331B
R114	Metal Glaze	470 ohm	1/10 W	±5%		RK73K2A471J or CR21-471J or ERJ6GEYJ471B
R115	Metal Glaze	4.7 kohm	1/10 W	±5%		RK73K2A472J or CR21-472J or ERJ6GEYJ472B
R116	Metal Glaze	33 kohm	1/10 W	±5%		RK73K2A333J or CR21-333J or ERJ6GEYJ333B
R117	Metal Glaze	100 ohm	1/10 W	±5%		RK73K2A101J or CR21-101J or ERJ6GEYJ101B
R118	Metal Glaze	220 ohm	1/10 W	±5%		RK73K2A221J or CR21-221J or ERJ6GEYJ221B
R119	Metal Glaze	1 kohm	1/10 W	±5%		RK73K2A102J or CR21-102J or ERJ6GEYJ102B
R120	Metal Glaze	100 kohm	1/10 W	±5%		RK73K2A104J or CR21-104J or ERJ6GEYJ104B
R121	Metal Glaze	220 ohm	1/10 W	±5%		RK73K2A221J or CR21-221J or ERJ6GEYJ221B
R122	Metal Glaze	470 ohm	1/10 W	±5%		RK73K2A471J or CR21-471J or ERJ6GEYJ471B

Ref. No.	Description				RS Part No.	Mfr's Part No.
R123	Metal Glaze	10 kohm	1/10 W	±5%		RK73K2A103J or CR21-103J or ERJ6GEYJ103B
R124	Metal Glaze	10 kohm	1/10 W	±5%		RK73K2A103J or CR21-103J or ERJ6GEYJ103B
R125	Metal Glaze	100 ohm	1/10 W	±5%		RK73K2A101J or CR21-101J or ERJ6GEYJ101B
R126	Metal Glaze	1 kohm	1/10 W	±5%		RK73K2A102J or CR21-102J or ERJ6GEYJ102B
R127	Metal Glaze	3.3 kohm	1/10 W	±5%		RK73K2A332J or CR21-332J or ERJ6GEYJ332B
R128	Metal Glaze	2.2 kohm	1/10 W	±5%		RK73K2A222J or CR21-222J or ERJ6GEYJ222B
R129	Metal Glaze	1 kohm	1/10 W	±5%		RK73K2A102J or CR21-102J or ERJ6GEYJ102B
R130	Metal Glaze	33 kohm	1/10 W	±5%		RK73K2A333J or CR21-333J or ERJ6GEYJ333B
R131	Metal Glaze	10 kohm	1/10 W	±5%		RK73K2A103J or CR21-103J or ERJ6GEYJ103B
R132	Metal Glaze	33 kohm	1/10 W	±5%		RK73K2A333J or CR21-333J or ERJ6GEYJ333B
R133	Metal Glaze	820 ohm	1/10 W	±5%		RK73K2A821J or CR21-821J or ERJ6GEYJ821B
R134	Metal Glaze	10 kohm	1/10 W	±5%		RK73K2A103J or CR21-103J or ERJ6GEYJ103B
R135	Metal Glaze	82 kohm	1/10 W	±5%		RK73K2A823J or CR21-823J or ERJ6GEYJ823B
R136	Metal Glaze	22 kohm	1/10 W	±5%		RK73K2A223J or CR21-223J or ERJ6GEYJ223B
R137	Metal Glaze	8.2 kohm	1/10 W	±5%		RK73K2A822J or CR21-822J or ERJ6GEYJ822B
R138	Metal Glaze	18 kohm	1/10 W	±5%		RK73K2A183J or CR21-183J or ERJ6GEYJ183B
R139	Metal Glaze	5.6 kohm	1/10 W	±5%		RK73K2A562J or CR21-562J or ERJ6GEYJ562B
R140	Metal Glaze	33 kohm	1/10 W	±5%		RK73K2A333J or CR21-333J or ERJ6GEYJ333B
R141	Not used					
R142	Not used					

Ref. No.	Description				RS Part No.	Mfr's Part No.
R143	Metal Glaze	100 kohm	1/10 W	±5%		RK73K2A104J or CR21-104J or ERJ6GEYJ104B
R144	Metal Glaze	220 kohm	1/10 W	±5%		RK73K2A224J or CR21-224J or ERJ6GEYJ224B
R145	Metal Glaze	820 ohm	1/10 W	±5%		RK73K2A821J or CR21-821J or ERJ6GEYJ821B
R146	Metal Glaze	1 kohm	1/10 W	±5%		RK73K2A102J or CR21-102J or ERJ6GEYJ102B
R147	Metal Glaze	47 ohm	1/10 W	±5%		RK73K2A470J or CR21-470J or ERJ6GEYJ470B
R148	Metal Glaze	220 ohm	1/10 W	±5%		RK73K2A221J or CR21-221J or ERJ6GEYJ221B
R149	Metal Glaze	10 kohm	1/10 W	±5%		RK73K2A103J or CR21-103J or ERJ6GEYJ103B
R150	Metal Glaze	1 Mohm	1/10 W	±5%		RK73K2A105J or CR21-105J or ERJ6GEYJ105B
R151	Metal Glaze	10 kohm	1/10 W	±5%		RK73K2A103J or CR21-103J or ERJ6GEYJ103B
R152	Metal Glaze	1 kohm	1/10 W	±5%		RK73K2A102J or CR21-102J or ERJ6GEYJ102B
R153	Metal Oxide	1 kohm	1/2 W	±5%		RSS1/2L10-102J or ERG12SJ102P
R154	Metal Oxide	10 ohm	1 W	±5%		RSS1L12.5-100J or ERG1SJ100P
R155	Not used					
R156	Metal Glaze	100 kohm	1/10 W	±5%		RK73K2A104J or CR21-104J or ERJ6GEYJ104B
R157	Metal Glaze	47 kohm	1/10 W	±5%		RK73K2A473J or CR21-473J or ERJ6GEYJ473B
R158	Metal Glaze	47 kohm	1/10 W	±5%		RK73K2A473J or CR21-473J or ERJ6GEYJ473B
R159	Metal Glaze	1 Mohm	1/10 W	±5%		RK73K2A105J or CR21-105J or ERJ6GEYJ105B
R160	Metal Glaze	2.2 kohm	1/10 W	±5%		RK73K2A222J or CR21-222J or ERJ6GEYJ222B
R161	Metal Glaze	680 ohm	1/10 W	±5%		RK73K2A681J or CR21-681J or ERJ6GEYJ681B
R162	Metal Glaze	100 ohm	1/10 W	±5%		RK73K2A101J or CR21-101J or ERJ6GEYJ101B

Ref. No.	Description				RS Part No.	Mfr's Part No.
R163	Fuse	1 ohm	1 W	±5%		RF1SL15-010J
R164	Fuse	4.7 ohm	1/2 W	±5%		RF50S-4R7J or ERQ12AJ4R7
R165	Metal Glaze	100 ohm	1/10 W	±5%		RK73K2A101J or CR21-101J or ERJ6GEYJ101B
R166	Metal Glaze	47 kohm	1/10 W	±5%		RK73K2A473J or CR21-473J or ERJ6GEYJ473B
R167	Metal Glaze	100 ohm	1/10 W	±5%		RK73K2A101J or CR21-101J or ERJ6GEYJ101B
R168	Metal Glaze	10 kohm	1/10 W	±5%		RK73K2A103J or CR21-103J or ERJ6GEYJ103B
R169	Metal Glaze	2.2 ohm	1/10 W	±5%		RK73M2A2R2J or CR21-2R2J or ERJ6GEYJ2R2B
R170	Metal Glaze	120 ohm	1/2 W	±5%		RK73K2H121J or ERJ12YJ121B
R171	Metal Oxide	10 ohm	1 W	±5%		RSS1L12.5-100J or ERG1SJ100P
R172	Metal Oxide	1 kohm	1/2 W	±5%		RSS1/2L10-102J or ERG12SJ102P
R173	Metal Oxide	100 kohm	1/2 W	±5%		RSS1/2L10-104J or SPR1/2L10-104J or ER050CKF1003
R174	Not used					
R175	Metal Glaze	33 kohm	1/10 W	±5%		RK73K2A333J or CR21-333J or ERJ6GEYJ333B
R176	Metal Glaze	22 kohm	1/10 W	±5%		RK73K2A223J or CR21-223J or ERJ6GEYJ223B
R177	Metal Glaze	10 kohm	1/10 W	±5%		RK73K2A103J or CR21-103J or ERJ6GEYJ103B
R178	Not used					
R179	Metal Glaze	10 kohm	1/10 W	±5%		RK73K2A103J or CR21-103J or ERJ6GEYJ103B
R180	Metal Glaze	220 kohm	1/10 W	±5%		RK73K2A224J or CR21-224J or ERJ6GEYJ224B
R181	Metal Glaze	22 kohm	1/10 W	±5%		RK73K2A223J or CR21-223J or ERJ6GEYJ223B
R182	Metal Glaze	100 kohm	1/10 W	±5%		RK73K2A104J or CR21-104J or ERJ6GEYJ104B
R183	Metal Glaze	100 ohm	1/10 W	±5%		RK73K2A101J or CR21-101J or ERJ6GEYJ101B
R184	Metal Glaze	5.6 kohm	1/10 W	±5%		RK73K2A562J or CR21-562J or ERJ6GEYJ562B

Ref. No.	Description				RS Part No.	Mfr's Part No.
R185	Metal Glaze	10 kohm	1/10 W	±5%		RK73K2A103J or CR21-103J or ERJ6GEYJ103B
R186	Metal Glaze	4.7 kohm	1/10 W	±5%		RK73K2A472J or CR21-472J or ERJ6GEYJ472B
R187	Metal Glaze	15 kohm	1/10 W	±5%		RK73K2A153J or CR21-153J or ERJ6GEYJ153B
R188	Metal Glaze	33 kohm	1/10 W	±5%		RK73K2A333J or CR21-333J or ERJ6GEYJ333B
R189	Metal Glaze	1 kohm	1/10 W	±5%		RK73K2A102J or CR21-102J or ERJ6GEYJ102B
R190	Metal Oxide	100 kohm	1/2 W	±5%		RSS1/2L10-104J or SPR1/2L10-104J or ER050CKF1003
R191	Metal Glaze	10 kohm	1/10 W	±5%		RK73K2A103J or CR21-103J or ERJ6GEYJ103B
R192	Metal Glaze	100 kohm	1/10 W	±5%		RK73K2A104J or CR21-104J or ERJ6GEYJ104B
R193	Metal Glaze	15 kohm	1/10 W	±5%		RK73K2A153J or CR21-153J or ERJ6GEYJ153B

Transformers

T1	Not used					
T2	RF					7TSA-358
T3	RF					7TSA-357
T4	RF					7TSA-356
T5	RF (Bar Antenna)					11TNA-355
T6	Mixer					10PSA-367
T7	Mixer					7TSR-359
T8	IF	455 kHz				7PSI-368
T9	IF	455 kHz				7PSI-369
T10	BFO					7PSI-369
T11	BFO					7PSI-369
T12	IF	45 MHz				7TSR-365

Trimmer Capacitors

TC1	30 pF					ECRLA030E12
TC2	30 pF					ECRLA030E12
TC3	30 pF					ECRLA030E12

Semi-Fixed Resistor

VR1	4.7 kohm					RH0615CS3J01A
VR2	10 kohm					RH0615C14J01A 10k

Ref. No.	Description	RS Part No.	Mfr's Part No.
Crystals and Ceramic Resonator			
X1 X2 X3 X4	44.55 MHz Crystal 451.5 kHz Ceramic 458.5 kHz Ceramic 33 MHz Crystal		44.550MHz(20-16245) CSB451J002 CSB458J001 33MHz(20-16018)
Crystal Filter			
XF1	45 MHz		MF45R2(20-15933)
Miscellaneous			
CN1 CN2 CN3 CN4 CN5 CN6 CN7 J2 J3 J4 J5 SW1 SW2 TP1 33 34 35 36 37	Connector, 8-pin Male Connector, 5-pin Male Connector, 5-pin Male Connector, 5-pin Male Connector, 7-pin Male Connector, 3-pin Male Connector, 2-pin Male Jack, Antenna (High-Impedance) Jack, Tape Out Jack, External Speaker Jack, External Power Switch, Attenuator Switch, Reset Pin, Test Case, Shield Bottom Case, Shield Case, Shield Top Shield, D-D converter Top Shield, D-D converter Bottom		53253-0810 53253-0510 53253-0510 53253-0510 53253-0710 53253-0310 53253-0210 S-Q3097 #01 S-Q3097 #01 S-G8036 MOJ-D14 SSFZUB22-07 SKHHLP GE-87D-7290 GE-93D-0702 GE-86D-6376 GE-88D-7571 GE-95D-1503 GE-95D-1504

LOGIC PCB ASSEMBLY

Ref. No.	Description				RS Part No.	Mfr's Part No.
38	PCB Assembly, Logic					
	Consists of the following:					GA-95D-1462
Capacitors						
C201	Ceramic	0.1 μ F	25 V	$\pm 20\%$ or +80%-20%		GRM40F104M25PB or CM21Y5V104Z25A or ECUX1E104ZFX
C202	Ceramic	0.1 μ F	25 V	$\pm 20\%$ or +80%-20%		GRM40F104M25PB or CM21Y5V104Z25A or ECUX1E104ZFX
C203	Ceramic	0.1 μ F	25 V	$\pm 20\%$ or +80%-20%		GRM40F104M25PB or CM21Y5V104Z25A or ECUX1E104ZFX
C204	Electrolytic	100 μ F	16 V	$\pm 20\%$		16UTCM101 or SMB16V101M or USR1C101MCA
C205	Ceramic	0.022 μ F	50 V	$\pm 20\%$		GRM40B223M50PB or CM21W5R223M50A or ECUX1H223MBX or ECUX1H223KBX
C206	Ceramic	0.022 μ F	50 V	$\pm 10\%$ $\pm 20\%$		GRM40B223M50PB or CM21W5R223M50A or ECUX1H223MBX or ECUX1H223KBX
C207	Ceramic	0.022 μ F	50 V	$\pm 10\%$ $\pm 20\%$		GRM40B223M50PB or CM21W5R223M50A or ECUX1H223MBX or ECUX1H223KBX
C208	Ceramic	0.022 μ F	50 V	$\pm 10\%$ $\pm 20\%$		GRM40B223M50PB or CM21W5R223M50A or ECUX1H223MBX or ECUX1H223KBX
C209	Not used			$\pm 10\%$		
C210	Ceramic	33 pF	50 V	$\pm 5\%$		GRM40CH330J50PB or CM21CH330J50A or ECUX1H330JCG
C211	Ceramic	0.1 μ F	25 V	$\pm 20\%$ or +80%-20%		GRM40F104M25PB or CM21Y5V104Z25A or ECUX1E104ZFX
C212	Electrolytic	100 μ F	16 V	$\pm 20\%$		16UTCM101 or SMB16V101M or USR1C101MCA
C213	Ceramic	0.1 μ F	25 V	$\pm 20\%$ or +80%-20%		GRM40F104M25PB or CM21Y5V104Z25A or ECUX1E104ZFX
C214	Ceramic	0.022 μ F	50 V	$\pm 20\%$		GRM40B223M50PB or CM21W5R223M50A or ECUX1H223MBX or ECUX1H223KBX
C215	Ceramic	0.022 μ F	50 V	$\pm 10\%$ $\pm 20\%$		GRM40B223M50PB or CM21W5R223M50A or ECUX1H223MBX or ECUX1H223KBX
C216	Ceramic	0.022 μ F	50 V	$\pm 10\%$ $\pm 20\%$		GRM40B223M50PB or CM21W5R223M50A or ECUX1H223MBX or ECUX1H223KBX

Ref. No.	Description				RS Part No.	Mfr's Part No.
C217	Ceramic	0.001 μ F	50 V	$\pm 10\%$		GRM40B102K50PB or CM21W5R102K50A or ECUX1H102KBN
C218	Ceramic	0.001 μ F	50 V	$\pm 10\%$		GRM40B102K50PB or CM21W5R102K50A or ECUX1H102KBN
C219	Ceramic	0.001 μ F	50 V	$\pm 10\%$		GRM40B102K50PB or CM21W5R102K50A or ECUX1H102KBN
C220	Ceramic	0.001 μ F	50 V	$\pm 10\%$		GRM40B102K50PB or CM21W5R102K50A or ECUX1H102KBN
C221	Ceramic	0.001 μ F	50 V	$\pm 10\%$		GRM40B102K50PB or CM21W5R102K50A or ECUX1H102KBN
C222	Ceramic	0.001 μ F	50 V	$\pm 10\%$		GRM40B102K50PB or CM21W5R102K50A or ECUX1H102KBN
C223	Ceramic	0.001 μ F	50 V	$\pm 10\%$		GRM40B102K50PB or CM21W5R102K50A or ECUX1H102KBN

Diodes

D201	1SS354TE	Marked 13	Silicon		1SS354TE
D202	DA227	Marked N20	Silicon		DA227
D203	DA227	Marked N20	Silicon		DA227
D204	1SS354TE	Marked 13	Silicon		1SS354TE
D205	1SS181	Marked A3	Silicon		1SS181
D206	MA724	Marked M1T	Silicon		MA724
D207	1SS354TE	Marked 13	Silicon		1SS354TE
D208	DA227	Marked N20	Silicon		DA227

Integrated Circuits

IC201	GRE-9351	Microprocessor 8-bit	MOS	SMT	GRE-9351
IC202	TA78L008AP or KIA78L08BP	Voltage Regulator	Bipolar		TA78L008AP or KIA78L08BP
IC203	S-81250HG-RD	Voltage Regulator	MOS	SMT	S-81250HG-RD
IC204	S-8054HN-CB	Voltage Detector	MOS	SMT	S-8054HN-CB
IC205	S-8052HNM-CR	CPU Reset	MOS	SMT	S-8052HNM-CR
IC206	M62354FP-75NC	D-A Converter	MOS	SMT	M62354FP-75NC

Ref. No.	Description				RS Part No.	Mfr's Part No.
Coil						
L201	Choke	10 μ H				LK2125100K
L202	Choke	10 μ H				LK2125100K
L203	Choke	10 μ H				LK2125100K
L204	Choke	10 μ H				LK2125100K
L205	Choke	10 μ H				LK2125100K
LEDs						
LED201	LT1E51A					LT1E51A
LED202	LT1E51A					LT1E51A
LED203	LT1E51A					LT1E51A
LED204	LT1E51A					LT1E51A
LED205	LT1E51A					LT1E51A
LED206	LT1E51A					LT1E51A
LED207	LT1E51A					LT1E51A
LED208	LT1E51A					LT1E51A
LED209	LT1E51A					LT1E51A
Transistors						
Q201	UN5214	Marked 8D		NPN		UN5214
Q202	UN5214	Marked 8D		NPN		UN5214
Q203	UN5214	Marked 8D		NPN		UN5214
Q204	UN5214	Marked 8D		NPN		UN5214
Q205	UN5214	Marked 8D		NPN		UN5214
Q206	UN5214	Marked 8D		NPN		UN5214
Q207	UN5214	Marked 8D		NPN		UN5214
Q208	UN5214	Marked 8D		NPN		UN5214
Q209	UN5214	Marked 8D		NPN		UN5214
Resistors						
R201	Metal Glaze	270 ohm	1/10 W	\pm 5%		RK73K2A271J or CR21-271J or ERJ6GEYJ271B
R202	Metal Glaze	100 ohm	1/10 W	\pm 5%		RK73K2A101J or CR21-101J or ERJ6GEYJ101B
R203	Metal Glaze	100 ohm	1/10 W	\pm 5%		RK73K2A101J or CR21-101J or ERJ6GEYJ101B
R204	Metal Glaze	100 ohm	1/10 W	\pm 5%		RK73K2A101J or CR21-101J or ERJ6GEYJ101B
R205 to R207	Not used					RK73K2A101J or CR21-101J or ERJ6GEYJ101B

Ref. No.	Description				RS Part No.	Mfr's Part No.
R208	Metal Glaze	1 kohm	1/10 W	±5%		RK73K2A102J or CR21-102J or ERJ6GEYJ102B
R209	Metal Glaze	1 kohm	1/10 W	±5%		RK73K2A102J or CR21-102J or ERJ6GEYJ102B
R210	Metal Glaze	1 Mohm	1/10 W	±5%		RK73K2A105J or CR21-105J or ERJ6GEYJ105B
R211 to R213	Not used					
R214	Metal Glaze	1 kohm	1/10 W	±5%		RK73K2A102J or CR21-102J or ERJ6GEYJ102B
R215	Metal Glaze	1 kohm	1/10 W	±5%		RK73K2A102J or CR21-102J or ERJ6GEYJ102B
R216	Metal Glaze	1 kohm	1/10 W	±5%		RK73K2A102J or CR21-102J or ERJ6GEYJ102B
R217	Metal Glaze	1 kohm	1/10 W	±5%		RK73K2A102J or CR21-102J or ERJ6GEYJ102B
R218	Metal Glaze	1 kohm	1/10 W	±5%		RK73K2A102J or CR21-102J or ERJ6GEYJ102B
R219	Metal Glaze	1 kohm	1/10 W	±5%		RK73K2A102J or CR21-102J or ERJ6GEYJ102B
R220	Metal Glaze	1 kohm	1/10 W	±5%		RK73K2A102J or CR21-102J or ERJ6GEYJ102B
R221	Metal Glaze	1 kohm	1/10 W	±5%		RK73K2A102J or CR21-102J or ERJ6GEYJ102B
R222	Metal Glaze	1 kohm	1/10 W	±5%		RK73K2A102J or CR21-102J or ERJ6GEYJ102B
R223	Metal Glaze	1 kohm	1/10 W	±5%		RK73K2A102J or CR21-102J or ERJ6GEYJ102B
R224	Metal Glaze	1 kohm	1/10 W	±5%		RK73K2A102J or CR21-102J or ERJ6GEYJ102B
R225	Metal Glaze	1 kohm	1/10 W	±5%		RK73K2A102J or CR21-102J or ERJ6GEYJ102B
R226	Metal Glaze	100 kohm	1/10 W	±5%		RK73K2A104J or CR21-104J or ERJ6GEYJ104B
R227	Metal Glaze	100 kohm	1/10 W	±5%		RK73K2A104J or CR21-104J or ERJ6GEYJ104B
R228	Metal Glaze	100 kohm	1/10 W	±5%		RK73K2A104J or CR21-104J or ERJ6GEYJ104B

Ref. No.	Description				RS Part No.	Mfr's Part No.
R229	Metal Glaze	100 kohm	1/10 W	±5%		RK73K2A104J or CR21-104J or ERJ6GEYJ104B
R230	Not used					
R231	Metal Glaze	390 ohm	1/10 W	±5%		RK73K2A391J or CR21-391J or ERJ6GEYJ391B
R232	Metal Glaze	390 ohm	1/10 W	±5%		RK73K2A391J or CR21-391J or ERJ6GEYJ391B
R233	Metal Glaze	1 kohm	1/10 W	±5%		RK73K2A102J or CR21-102J or ERJ6GEYJ102B
R234	Metal Glaze	100 kohm	1/10 W	±5%		RK73K2A104J or CR21-104J or ERJ6GEYJ104B
R235	Metal Glaze	47 kohm	1/10 W	±5%		RK73K2A473J or CR21-473J or ERJ6GEYJ473B
R236	Metal Glaze	8.2 kohm	1/10 W	±5%		RK73K2A822J or CR21-822J or ERJ6GEYJ822B
R237	Metal Glaze	10 kohm	1/10 W	±5%		RK73K2A103J or CR21-103J or ERJ6GEYJ103B
R238	Metal Glaze	1 kohm	1/10 W	±5%		RK73K2A102J or CR21-102J or ERJ6GEYJ102B
R239	Metal Glaze	1 kohm	1/10 W	±5%		RK73K2A102J or CR21-102J or ERJ6GEYJ102B
R240	Metal Glaze	1 kohm	1/10 W	±5%		RK73K2A102J or CR21-102J or ERJ6GEYJ102B
R241	Metal Glaze	100 kohm	1/10 W	±5%		RK73K2A104J or CR21-104J or ERJ6GEYJ104B
R242	Metal Glaze	10 kohm	1/10 W	±5%		RK73K2A103J or CR21-103J or ERJ6GEYJ103B
R243	Metal Glaze	2.2 kohm	1/10 W	±5%		RK73K2A222J or CR21-222J or ERJ6GEYJ222B

Ref. No.	Description	RS Part No.	Mfr's Part No.
Trimmer Capacitor			
TC201	30 pF		ECRLA030E12
Resonators			
X201 X202	Ceramic Crystal	4.5 MHz 32.768kHz	EFOS4504E5 DS-VT-200(32.768kHz)
Miscellaneous			
SW201 40 SW202 40 SW203 VR202 40 VR203 40 LCD201 BT201	Assembly, Switch Switch, Mode Nut, 9 mm Diameter Assembly, Fine Tuning Encoder, Rotary (Fine Tuning) Nut, 9 mm Diameter Encoder, Rotary (Main Tuning) Assembly, Volume Potentiometer 50 kohm Nut, 9 mm Diameter Assembly, Control RF Gain Potentiometer 50 kohm Nut, 9 mm Diameter LCD Film, Optical Spread Reflector, LCD Holder, LCD Interconnector, LCD Battery, Lithium Shield, Logic Top Shield, Logic Bottom	3 V	GA-95D-1475 SRBV1600252X GE-94D-1286 GA-95D-1476 EC16B24104 GE-94D-1286 EC16B24104 GA-95D-1477 RK11K1140 50KA GE-94D-1286 GA-95D-1478 RK11K1140 50KB GE-94D-1286 EDD094YG0A4 GE-95D-1369 GE-94D-1271 GE-94D-1272 GE-94D-1273 VL2020/1HF GE-95D-1496 GE-95D-1497

HEADPHONE JACK PCB ASSEMBLY

Ref. No.	Description	RS Part No.	Mfr's Part No.
39	PCB Assembly, Headphone Jack Consists of the following:		GA-95D-1464
Miscellaneous			
J301	Jack, Headphone		HSJ0836-01-500

SEMICONDUCTOR LEAD IDENTIFICATION

INTEGRATED CIRCUIT

IC1 MB87014APF-G-BND

IC2 μ PC358G

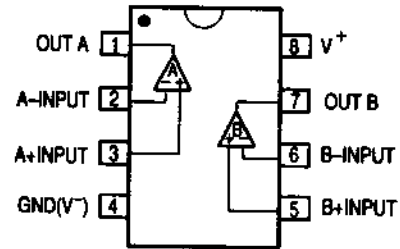
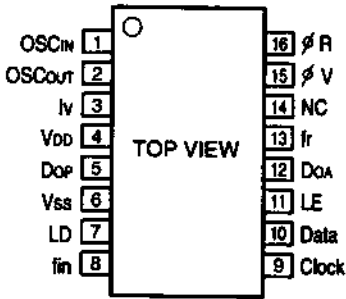

IC3 TC4066BF

IC4 TDA1905

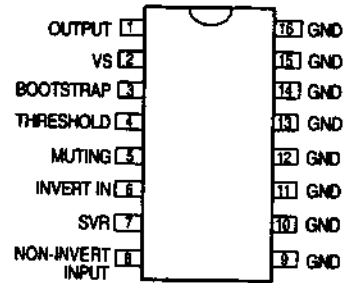
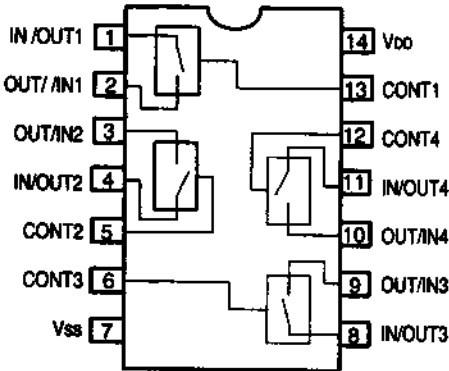

IC5 TK11806M

IC6 TA78L005AP

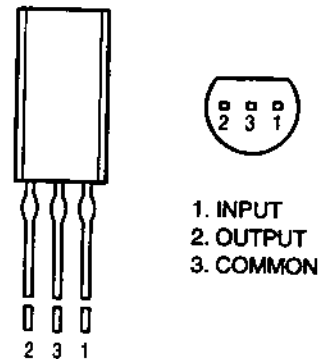
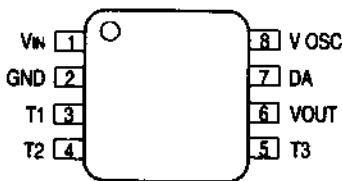

IC201 See Microprocessor Port Format on page 61.

IC202 TA78L008AP
or KIA78L08PF

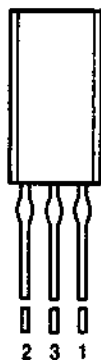

1. INPUT
2. OUTPUT
3. COMMON

IC203 S-81250HG-RD

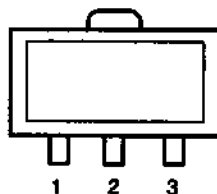

1. GND
2. Vin
3. Vout

IC204 S-8054HN-CB
IC205 S-8052HNM-CR

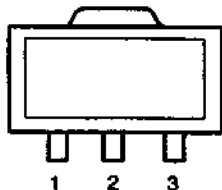

1. OUT
2. V_{DD}
3. V_{SS}

IC206 M62354FP-75NC

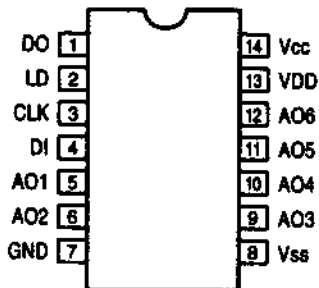

TRANSISTORS

(A) 2SA1162(G)
2SC2712(GR)
2SC2714(O)
KEC3875S(GR)
UN5111
UN5214

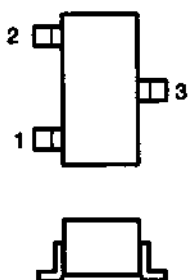

1. Emitter
2. Base
3. Collector

(B) 2SA1241(Y)(LB)

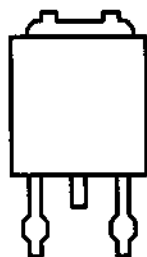

1. Base
2. Collector
3. Emitter

(C) 2SK209(Y)

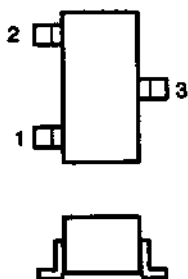

1. Drain
2. Source
3. Gate

(D) 2SK210(Y)

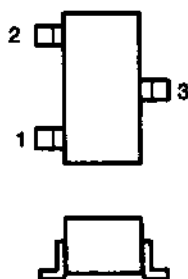

1. Gate
2. Drain
3. Source

(E) 3SK195

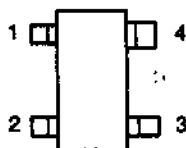

1. Gate1
2. Gate2
3. Drain
4. Source

DIODES

(A) 1N4002
or DPA05
or HVM14S

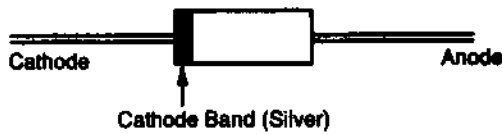

(B) 1SS181

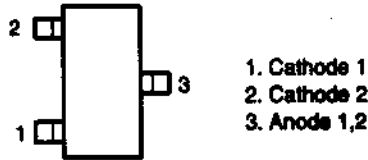

(C) 1SS272

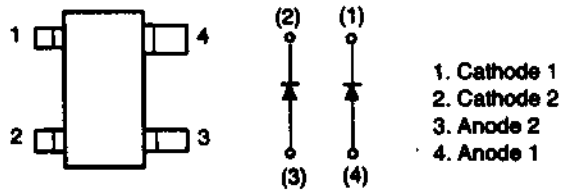

(D) 1SS354TE

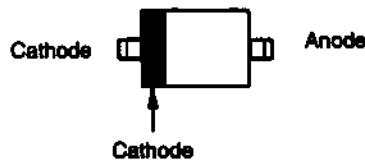

(E) 1SV172

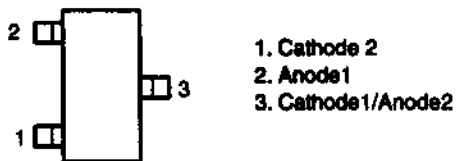

(F) DA227

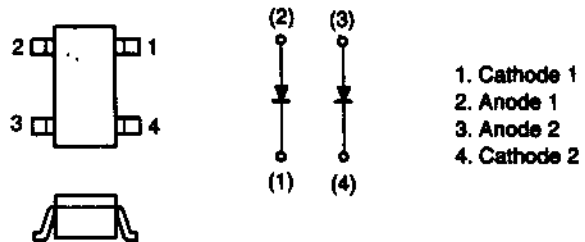

(G) HSU277

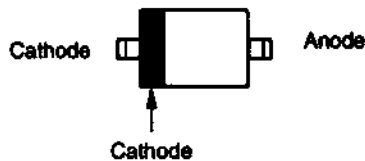

(H) HVU17



(I) HVU300A



(J) MA724

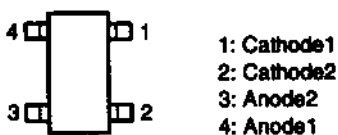

(K) RC202

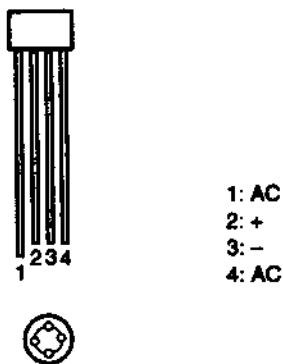

(L) ZSML-7.5(Y)



MICROPROCESSOR PORT FORMAT

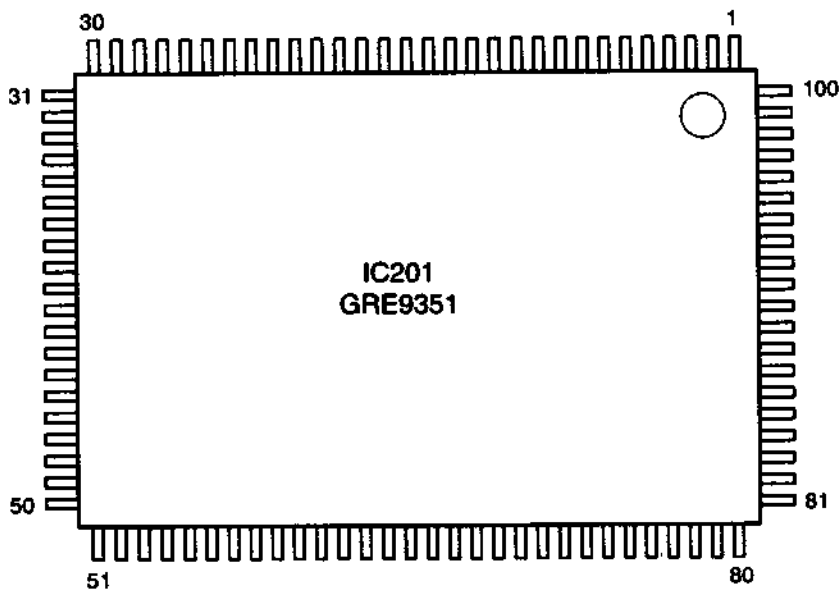

Pin	Function	Pin	Function	Pin	Function
1	PLL data output	35	NC	69	LCD segment 9 output
2	PLL clock output	36	AVdd	70	LCD segment 10 output
3	D/A EN output	37	AV reference	71	LCD segment 11 output
4	D/A data output	38	AM output	72	LCD segment 12 output
5	D/A clock	39	USB output	73	LCD segment 13 output
6	IC (Vpp)	40	Vss	74	LCD segment 14 output
7	X2	41	LSB output	75	LCD segment 15 output
8	X1	42	CW output	76	LCD segment 16 output
9	Vdd	43	STAND BY input	77	LCD segment 17 output
10	XT1	44	AM input	78	LCD segment 18 output
11	XT2	45	USB input	79	LCD segment 19 output
12	Reset input	46	LSB input	80	LCD segment 20 output
13	NC	47	CW1 input	81	LCD segment 21 output
14	Main tuning input	48	CW2 input	82	LCD segment 22 output
15	Main tuning input	49	Key tone output	83	LCD segment 23 output
16	Fine tuning input	50	Mute output	84	LCD segment 24 output
17	Fine tuning input	51	LCD common 0 output	85	LCD segment 25 output
18	Hold input	52	LCD common 1 output	86	LCD segment 26 output
19	Key input	53	LCD common 2 output	87	LCD segment 27 output
20	Key input	54	LCD common 3 output	88	LCD segment 28 output
21	Key input	55	LCD bias	89	LCD segment 29 output
22	Key input	56	V LCD0	90	LCD segment 30 output
23	Key input	57	V LCD1	91	LCD segment 31 output
24	Key input	58	V LCD2	92	LCD segment 32 output
25	Power output	59	Vss	93	LCD segment 33 output
26	Noise blanker output	60	LCD segment 0 output	94	NC
27	Vss	61	LCD segment 1 output	95	Band 5 output
28	Meter input	62	LCD segment 2 output	96	Band 4 output
29	Key output	63	LCD segment 3 output	97	Band 3 output
30	Key output	64	LCD segment 4 output	98	Band 2 output
31	Key output	65	LCD segment 5 output	99	Band 1 output
32	Key output	66	LCD segment 6 output	100	PLL EN output
33	Key output	67	LCD segment 7 output		
34	NC	68	LCD segment 8 output		

SCHEMATIC DIAGRAM

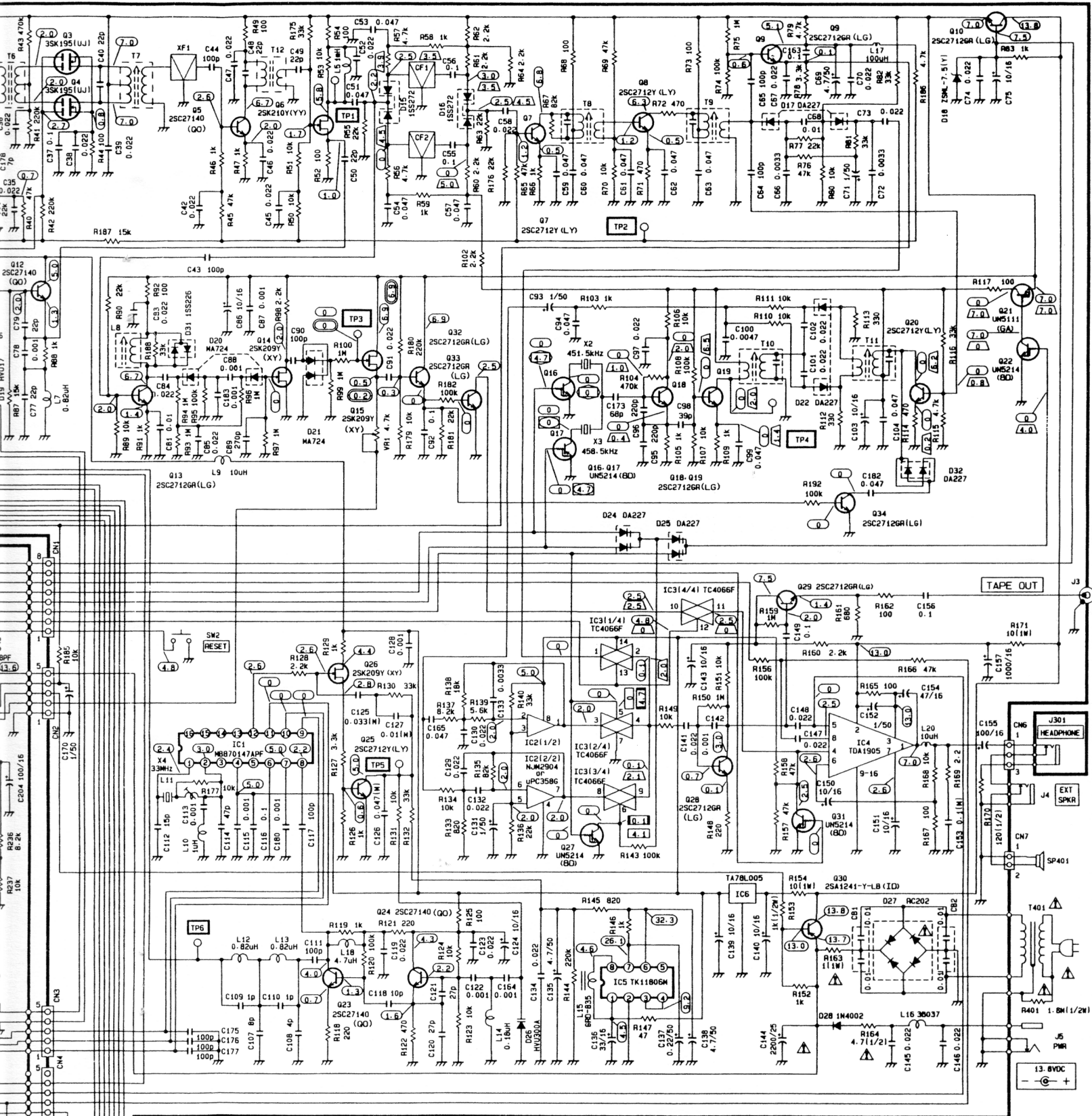

NOTES:

1. RESISTANCE VALUES ARE IN OHMS (K-KILO OHM M-MEGOHM)
2. CAPACITANCE VALUES ARE IN P (P-PICO FARAD)
3. (M) -MYLAR CAPACITOR
4. NO SUFFIX CERAMIC CAPACITOR
5. THIS SYMBOL DENOTES DC VOLTAGE WITH DC VOLTMETER (100kohm/V) UNDER FOLLOWING CONDITIONS.
6. CH 1 AM MODE AT 10MHZ - MANUAL OPERATION VOLUME AT MINIMUM AND SQUELCH CCW
7. THIS SYMBOL DENOTES VOLTAGES FOR USB/USB/CM MODE OPERATION
8. THIS SYMBOL DENOTES VOLTAGES FOR CW1 OR CW2 MODE OPERATION
9. THIS SYMBOL DENOTES VOLTAGES POWER OFF
10. THIS SYMBOL DENOTES VOLTAGES FOR USB OR LSB MODE OPERATION
11. THIS SYMBOL DENOTES VOLTAGES FOR NOISE BLANKER ON

12. THIS SYMBOL DENOTES VOLTAGES FOR LW MODE OPERATION
13. THIS SYMBOL DENOTES VOLTAGES FOR MW MODE OPERATION
14. THIS SYMBOL DENOTES VOLTAGES FOR SW MODE AT 2MHZ OPERATION
15. THIS SYMBOL DENOTES VOLTAGES FOR SW MODE AT 10MHZ OPERATION
16. THIS SYMBOL DENOTES VOLTAGES FOR SW MODE AT 15MHZ OPERATION
17. THIS SYMBOL DENOTES VOLTAGES FOR LSB/CW1 MODE OPERATION
18. THIS SYMBOL DENOTES VOLTAGES FOR USB/CW2 MODE OPERATION
19. RATING OR TYPE NUMBER OF COMPONENT PARTS ARE

SUBJECT TO CHANGE FOR IMPROVEMENT WITHOUT NOTICE

SCHEMATIC DIAGRAM

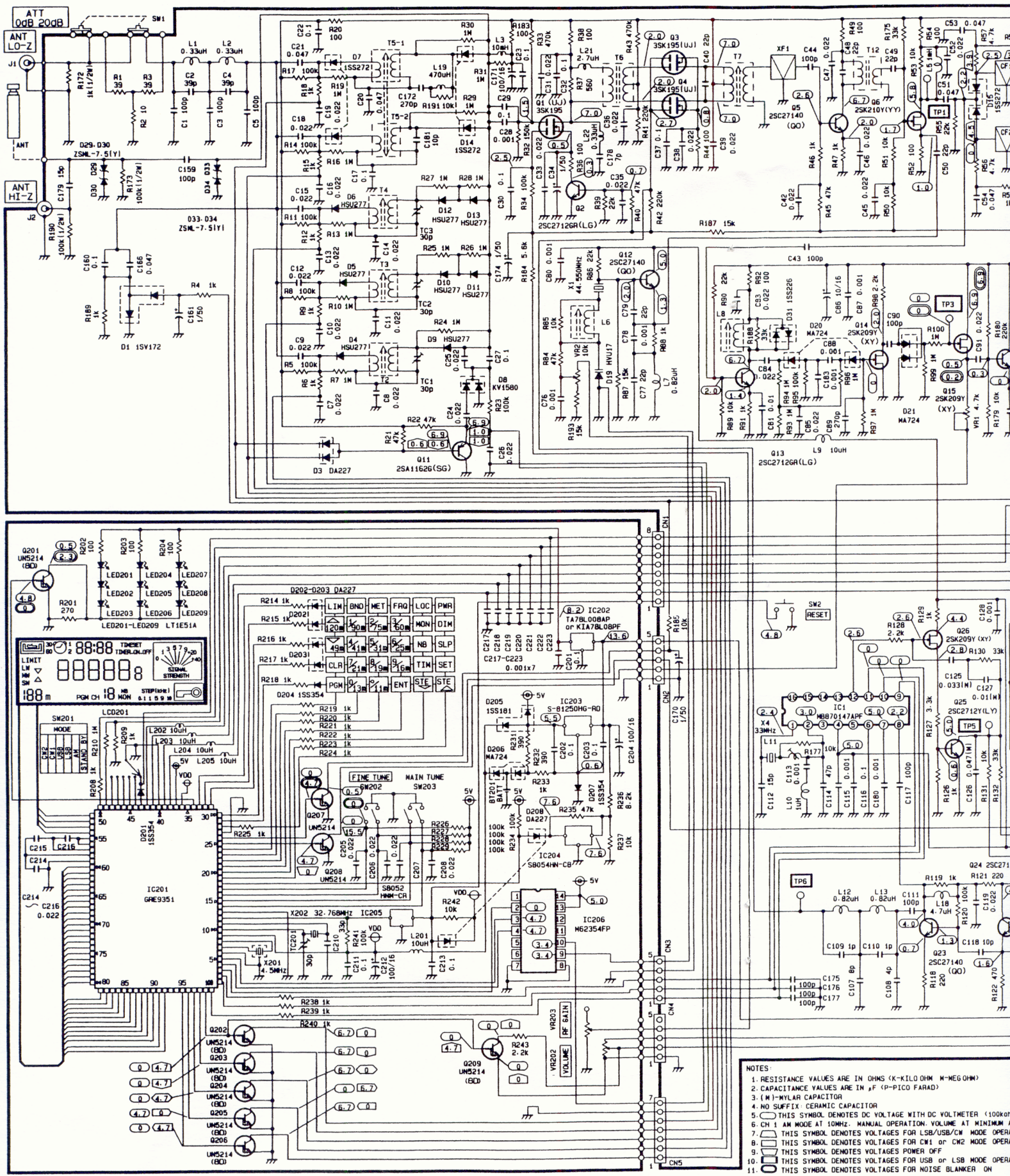

- NOTES:**
1. RESISTANCE VALUES ARE IN OHMS (K=KILO OHM M=MEG OHM)
 2. CAPACITANCE VALUES ARE IN μ F (P=PICO FARAD)
 3. (M)=MYLAR CAPACITOR
 4. NO SUFFIX CERAMIC CAPACITOR
 5. CH 1 THIS SYMBOL DENOTES DC VOLTAGE WITH DC VOLTMETER (100kohm)
 6. CH 1 AM MODE AT 10MHz. MANUAL OPERATION. VOLUME AT MINIMUM AND
 7. THIS SYMBOL DENOTES VOLTAGES FOR LSB/USB/CW MODE OPERAT
 8. THIS SYMBOL DENOTES VOLTAGES FOR CW1 or CW2 MODE OPERAT
 9. THIS SYMBOL DENOTES VOLTAGES POWER OFF
 10. THIS SYMBOL DENOTES VOLTAGES FOR USB or LSB MODE OPERAT
 11. THIS SYMBOL DENOTES VOLTAGES FOR NOISE BLANKER ON