

ECLIPSE DSC GX1000S

SERVICE MANUAL



Important Note

This transceiver was assembled using Pb (lead) free solder, based on the RoHS specification. Only lead-free solder (Alloy Composition: Sn-3.0Ag-0.5Cu) should be used for repairs performed on this apparatus. The solder stated above utilizes the alloy composition required for compliance with the lead-free specification, and any solder with the above alloy composition may be used.

Specifications

GENERAL

Channels:	All USA, International and Canadian
Input Voltage:	13.8 VDC \pm 20%
Current Drain:	Standby 0.3 A Receive 1.0 A Transmit 5.5 A (Hi); 1.5 A (Lo)
Individual DSC Directory Memory:	15
Dimensions:	2.4" H x 6.1" W x 6.7" D (60 H x 155 W x 170 D mm)
Flush-Mount Dimensions:	2.0" H x 5.2" W x 6.7" D (51 H x 131 W x 170 D mm)
Weight:	1.7 lbs (770 g)

TRANSMITTER

Frequency Range:	156.025 to 157.425 MHz
RF Output:	25 W (Hi); 1 W (Lo)
Conducted Spurious Emissions:	80 dB (Hi); 60 dB (Lo)
Audio Response:	within \pm 1/-3 of a 6 dB/octave pre-emphasis characteristic at 300 to 3000 Hz
Audio Distortion:	5 %
Modulation:	16K0G3E, for DSC 16K0G2B
Frequency Stability (-20°C to +50°C):	\pm 0.0005%
FM Hum and Noise:	50 dB

RECEIVER

Frequency Range:	156.050 to 163.275 MHz
Sensitivity:	12 dB SINAD 0.25 μ V
Squelch Sensitivity (Threshold):	0.15 μ V
Modulation Acceptance Bandwidth:	\pm 7.5 kHz
Selectivity (TYP):	-70 dB (Spurious and Image Rejection) -70 dB (Intermodulation and Rejection at 12 dB SINAD)
Audio Output:	4.5 W
Audio Response:	within \pm 2/-8 of a 6 dB/octave de-emphasis characteristic at 300 to 3000 Hz
Frequency Stability (-20°C to +50°C):	\pm 0.0005 %
Channel Spacing:	25 kHz
DSC Format:	RTCM SC101
NMEA Input/Output:	Output - DSC, DSE Input - GLL, GGA, RMC and GNS

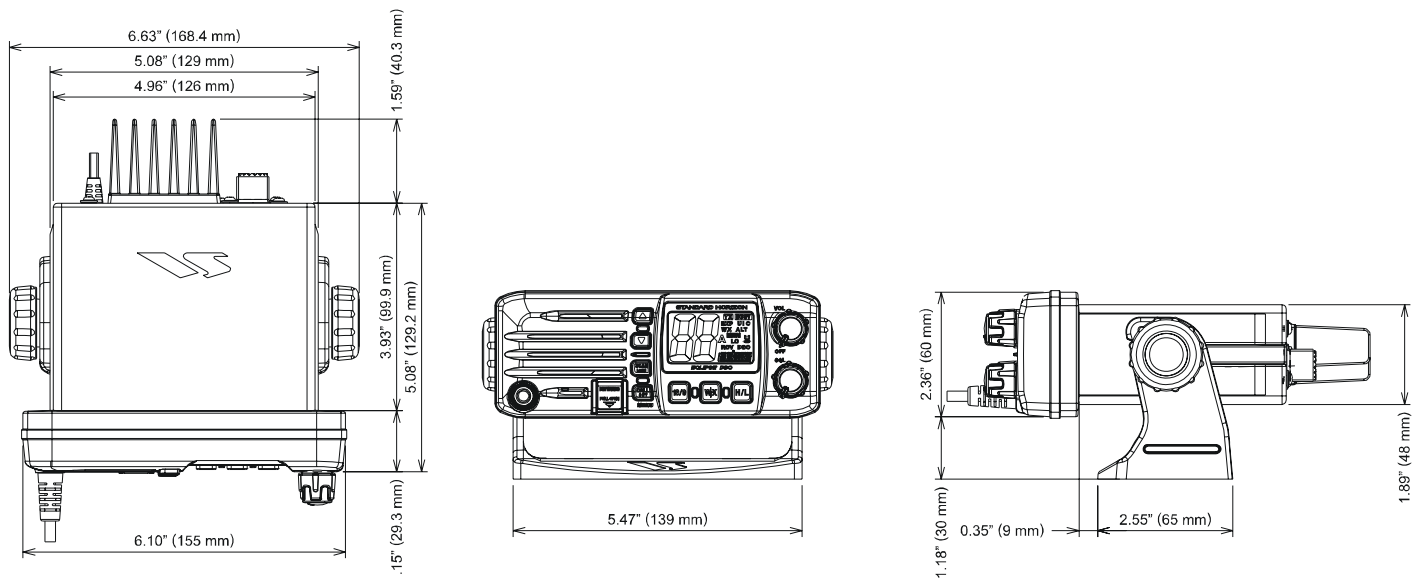

Performance specifications are nominal, unless otherwise indicated, and are subject to change without notice.

Measurements are made in accordance with EN301 025. All stated specifications are subject to change without notice or obligation.

Exploded View & Miscellaneous Parts

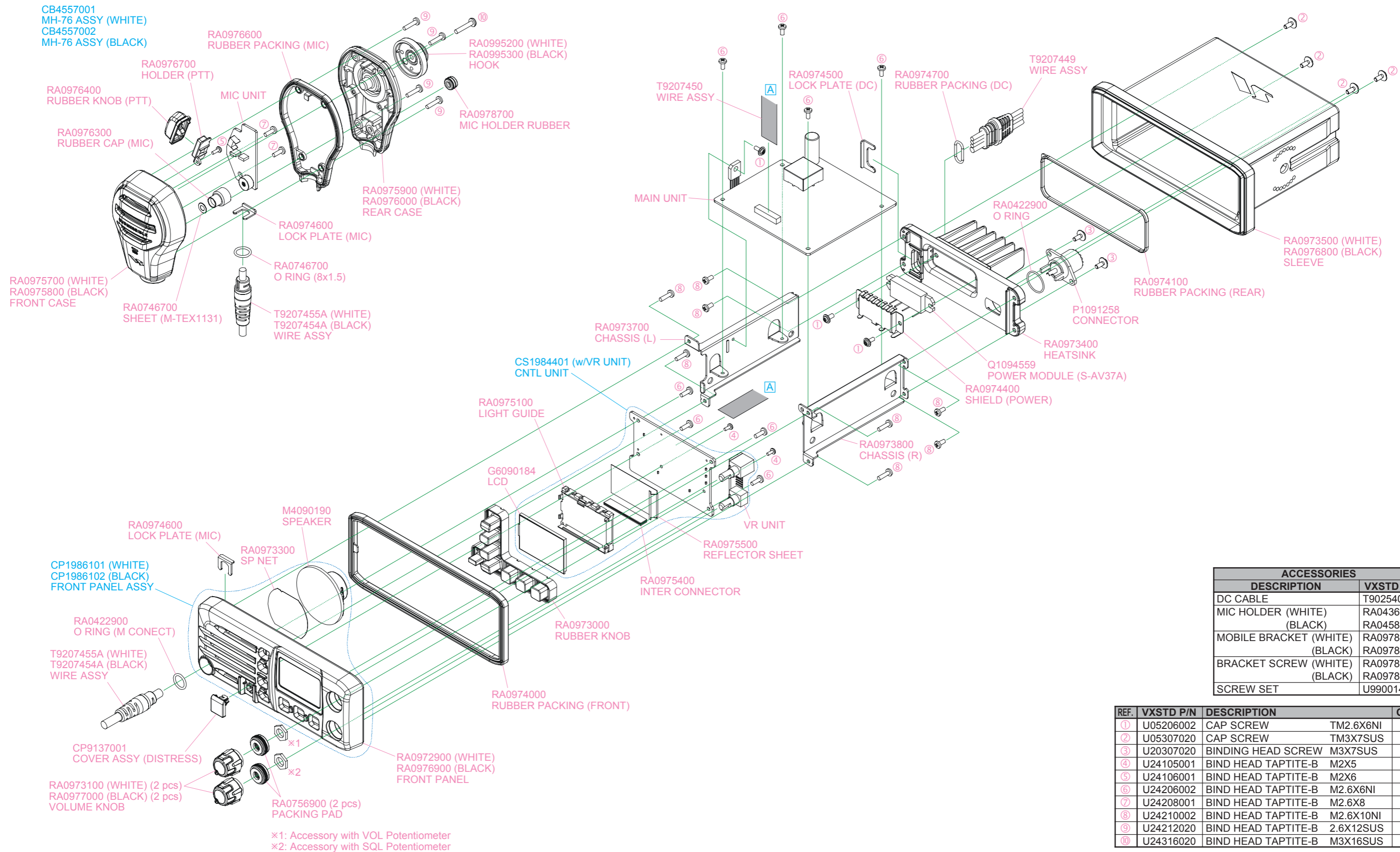

ACCESSORIES		
DESCRIPTION	VXSTD P/N	
DC CABLE	T9025406	
MIC HOLDER (WHITE)	RA0436000	
(BLACK)	RA0458800	
MOBILE BRACKET (WHITE)	RA0978300	
(BLACK)	RA0978400	
BRACKET SCREW (WHITE)	RA0978500	
(BLACK)	RA0978600	
SCREW SET	U9900147	

REF.	VXSTD P/N	DESCRIPTION	QTY.
①	U05206002	CAP SCREW TM2.6X6NI	3
②	U05307020	CAP SCREW TM3X7SUS	4
③	U20307020	BINDING HEAD SCREW M3X7SUS	2
④	U24105001	BIND HEAD TAPTITE-B M2X5	2
⑤	U24106001	BIND HEAD TAPTITE-B M2X6	1
⑥	U24206002	BIND HEAD TAPTITE-B M2.6X6NI	8
⑦	U24208001	BIND HEAD TAPTITE-B M2.6X8	2
⑧	U24210002	BIND HEAD TAPTITE-B M2.6X10NI	8
⑨	U24212020	BIND HEAD TAPTITE-B 2.6X12SUS	4
⑩	U24316020	BIND HEAD TAPTITE-B M3X16SUS	1

Non-designated parts are available only as part of a designated assembly.

Exploded View & Miscellaneous Parts

Note

Block Diagram

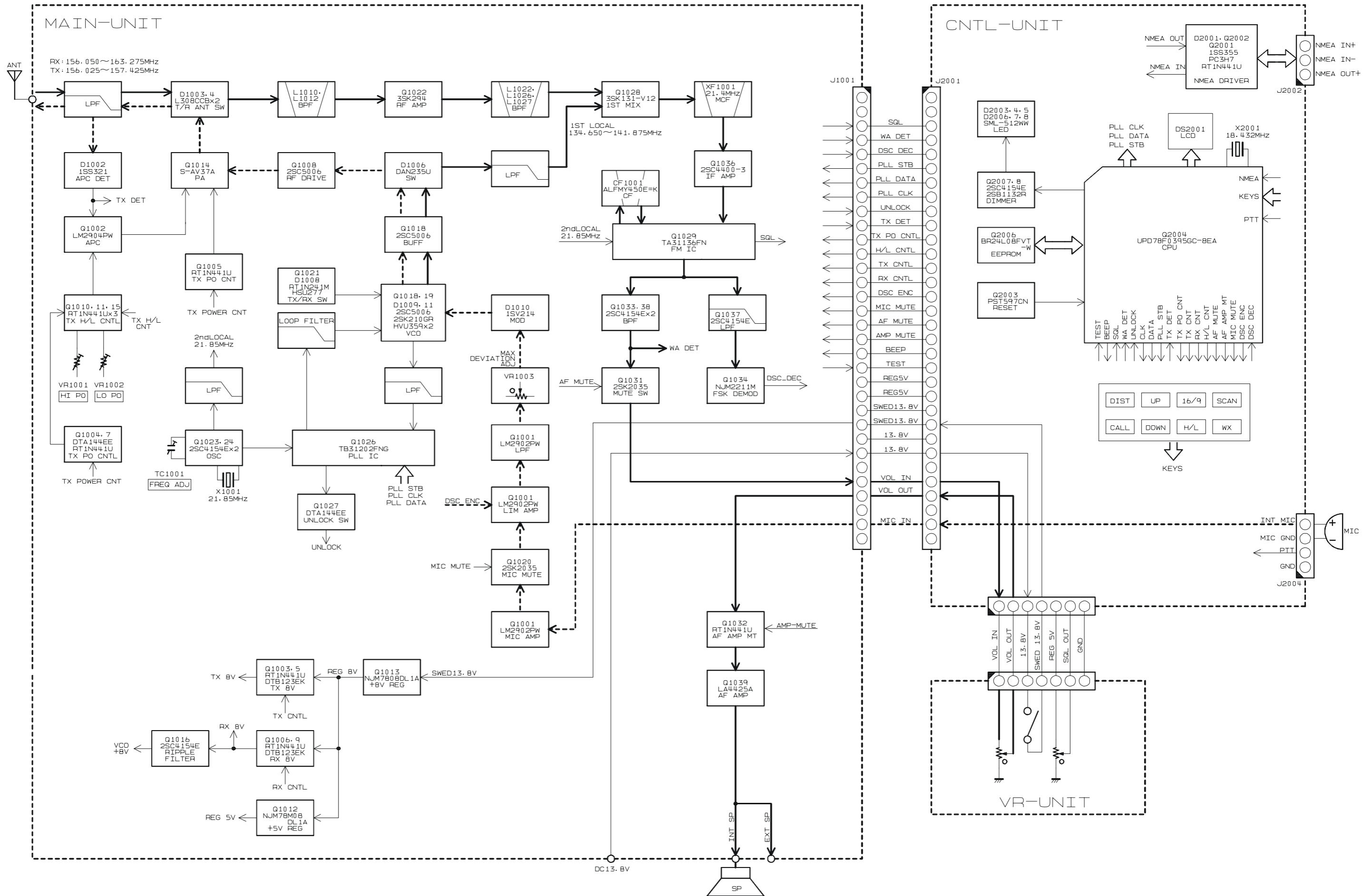

Block Diagram

Note

Circuit Description

Reception and transmission are switched by 8-bit MPU IC **Q2004 (UPD78F0395GC)** on the CNTL Unit. The receiver uses double-conversion superheterodyne circuitry, with a 21.4 MHz 1st IF and 450 kHz 2nd IF. The 1st local is produced by a PLL synthesizer, yielding the 21.4 MHz 1st IF. The 2nd local uses a 21.85 MHz crystal oscillator, yielding the 450 kHz 2nd IF. The 2nd mixer and other circuits use a custom IC to convert and amplify the 2nd IF and detect FM to obtain demodulated signals. During transmit, the PLL synthesizer oscillates at the desired frequency directly, for amplification to obtain RF power output. During transmit, voice modulation is applied to this synthesizer. Transceiver functions, such as TX/RX control, PLL synthesizer settings, and channel programming, are controlled using the MPU.

Receiver

Incoming RF signals from the antenna connector are delivered to the MAIN Unit, and pass through a low-pass filter (LPF) consisting of coils L1001 & L1002 and capacitors C1003, C1011, & C1024, and antenna switching diode **D1004 (L308CCB)** for delivery to the receiver front end.

Signals within the frequency range of the transceiver are passed through a bandpass filter consisting of coils L1006 & L1008 and capacitors C1027, C1036, & C1059, before RF amplifier **Q1022 (3SK294)**.

The amplified RF is passed through a bandpass filter consisting of coils L1022, L1026, & L1027 and capacitors C1145, C1150, C1115, C1159, C1170, C1174, & C1179. The pure in-band input signal is delivered to the main 1st mixer **Q1028 (3SK131)**.

Buffered output from the MAIN VCO is amplified by **Q1018** and **Q1019** (both **2SC5006**) and low-pass filtered by coils L1009 & L1011 and capacitors C1064, C1071, & C1076, to provide a pure 1st local signal between 134.625 and 136.025 MHz for delivery to the main 1st mixer.

The 21.4 MHz 1st mixer product is passed through the monolithic crystal filter XF1001 (± 6.5 kHz BW), and is amplified by **Q1036 (2SC4400)**.

After that, it is delivered to the input of the FM IF subsystem IC **Q1029 (TA31136FNG)**. This IC contains the 2nd mixer, 2nd local oscillator, limiter amplifier, FM detector, noise amplifier, and squelch gates.

The 2nd local in the FM IF subsystem IC **Q1029 (TA31136FNG)** is produced from crystal X1001 (21.850 MHz), and the 1st IF is converted to 450 kHz by the 2nd mixer and stripped of unwanted components by ceramic filter CF1001.

After passing through a limiter amplifier, the signal is demodulated by the FM detector. Demodulated audio from the FM IF subsystem IC **Q1029 (TA31136FNG)** is amplified by **Q1038** and **Q1033** (both **2SC4154**). The amplified signal is passed through the AF mute switch **Q1031 (2SK2035)** and the front panels volume control. The adjusted audio signal is delivered to the AF power amplifier **Q1039 (LA4425A)**.

The amplified audio signal is delivered to the 8 Ohms internal loudspeaker and external Speaker terminal in the accessory cable.

PLL Synthesizer

The 1st Local signal maintains stability from the PLL synthesizer by using a 21.850 MHz reference signal from crystal X1001. PLL synthesizer IC **Q1026 (TB31202FNG)** consists of a prescaler, reference counter, swallow counter, programmable counter, a serial data input port to set these counters based on the external data, a phase comparator, and a charge pump.

The PLL synthesizer IC divides the 21.850 MHz reference signal by 1748 using the reference counter (12.5 kHz comparison frequency).

The VCO output is divided by the prescaler, swallow counter and programmable counter. These two signals are compared by the phase comparator, and applied to the charge pump.

A voltage proportional to their phase difference is delivered to the low-pass filter circuit, then fed back to the VCO as a voltage with phase error, controlling and stabilizing the oscillating frequency. This synthesizer also operates as a modulator during transmit.

The VCO consists of **Q1019 (2SK210GR)** and varactor diodes **D1009** and **D1011** (both **HVU359**), which oscillates at 21.4 MHz below from the receiving frequency while receiving, and oscillates at the fundamental transmit frequency during a transmit with direct frequency-modulation using varactor diode **D1010 (1SV214)**. The VCO output passes through buffer amplifier **Q1018** and **Q1017** (both **2SC5006**) to obtain stable output, then applied to the 1st mixer of while receiving, and to the driver amplifier **Q1008 (2SC5006)** during a transmit.

The DC supply for the VCO is regulated by **Q1016 (2SC4154)**.

Circuit Description

Transmitter

The voice from the microphone is passed through the CNTL Unit to the microphone amplifier **Q1001 (LM2902PW)** on the MAIN Unit, a pre-emphasis network, limiter (IDC: instantaneous deviation control), and low-pass filter network, the audio is adjusted for optimum deviation level.

The voice or DSC (Digital Selective Calling) encoded signal from the low-pass filter network **Q1001 (LM2902PW)** is applied to the VCO **Q1019 (2SK210GR)** which oscillates at the fundamental transmit frequency with direct frequency-modulation using varactor diode **D1010 (1SV214)**. The modulated signal is amplified by the buffer amplifier **Q1018** and **Q1017** (both **2SC5006**), then passed through the diode switch **D1006 (DAN235U)** to drive amplifiers **Q1008 (2SC5006)** and RF power amplifier module **Q1014 (S-AV37A)**.

The RF energy then passes through antenna switch **D1003 (L308CCB)** and low-pass filter (LPF) consisting of coils L1001 & L1002 and capacitors C1003, C1011, & C1024, and finally to the antenna connector.

RF output power from the RF power amplifier module **Q1014 (S-AV37A)** is sampled by C1014 and C1021 and is rectified by **D1002 (1SS321)**. The resulting DC is fed through Automatic Power Controller **Q1007 (RT1N441U)** to RF power amplifier module **Q1014 (S-AV37A)**, thus providing positive control of the power output.

Generation of spurious products by the transmitter is minimized by the fundamental carrier frequency being equal to the final transmitting frequency, modulated directly in the transmit VCO. Additional harmonic suppression is provided by a low-pass filter consisting of coils and capacitors, resulting in more than 80 dB of harmonic suppression prior to delivery of the RF energy to the antenna.

DSC Encoder/ Decoder

Encoder

The DSC (Digital Selective Calling) encode signal which D/A converted in the 8-bit MPU **Q2004 (UPD78F0395GC)** on the CNTL Unit is fed through the low-pass filter **Q1001 (LM2902PWR)** on the MAIN Unit to the VCO **Q1019 (2SK210GR)**.

Decoder

A portion of the demodulated signal from the FM IF subsystem IC **Q1029 (TA31136FNG)** is passes through the low-pass filter **Q1037 (2SC4154)** to the DSC Decoder IC **Q1034 (NJM2211M)**. The decoded DCS signal delivered to the 8-bit MPU IC **Q2004 (UPD78F0395GC)** on the CNTL Unit.

1050 Hz Weather Alert Decoder

The 1050 Hz Weather Alert signal from the buffer amplifier **Q1033 (2SC4154)** is applied to 8-bit MPU IC **Q2004 (UPD78F0395GC)** on the CNTL Unit.

MPU

Operation is controlled by 8-bit MPU IC **Q2004 (UPD78F0395GC)** on the CNTL Unit. This MPU uses a 18.432 MHz crystal X2001 for the system clock. IC **Q2003 (PST597CN)** resets the MPU when the power is on.

EEPROM

The EEPROM **Q2006 (BR24L08FVT)** on the CNTL Unit retains TX and RX data for all memory channels, prescaler dividing, IF frequency, local oscillator injection side, and reference oscillator data.

The **GX1000S** has been carefully aligned at the factory for the specified performance across the marine band.

Realignment should therefore not be necessary except in the event of a component failure. All component replacement and service should be performed only by an authorized Standard Horizon representative, or the warranty policy may be voided.

The following procedures cover the sometimes critical and tedious adjustments that are not normally required once the transceiver has left the factory. However, if damage occurs and some parts are replaced, realignment may be required. If a sudden problem occurs during normal operation, it is likely due to component failure; realignment should not be done until after the faulty component has been replaced.

We recommend that servicing be performed only by authorized Standard Horizon service technicians who are experienced with the circuitry and fully equipped for repair and alignment. Therefore, if a fault is suspected, contact the dealer from whom the transceiver was purchased for instructions regarding repair. Authorized Standard Horizon service technicians realign all circuits and make complete performance checks to ensure compliance with factory specifications after replacing any faulty components.

Those who do undertake any of the following alignments are cautioned to proceed at their own risk. Problems caused by unauthorized attempts at realignment are not covered by the warranty policy. Also, Standard Horizon, a division of Vertex Standard must reserve the right to change circuits and alignment procedures in the interest of improved performance, without notifying owners. Under no circumstances should any alignment be attempted unless the normal function and operation of the transceiver are clearly understood, the cause of the malfunction has been clearly pinpointed and any faulty components replaced, and the need for realignment determined to be absolutely necessary.

The following test equipment (and thorough familiarity with its correct use) is necessary for complete realignment. Correction of problems caused by misalignment resulting from use of improper test equipment is not covered under the warranty policy. While most steps do not require all of the equipment listed, the interactions of some adjustments may require that more complex adjustments be performed afterwards. Do not attempt to perform only a single step unless it is clearly isolated electrically from all other steps. Have all test equipment ready before beginning, and follow all of the steps in a section in the order presented.

Required Test Equipment

- RF Signal Generator with calibrated output level at 200 MHz
- Deviation Meter (linear detector)
- AF Millivoltmeter
- SINAD Meter
- Inline Wattmeter with 5% accuracy at 200 MHz
- Regulated DC Power Supply: 13.8 VDC, 10A
- 50-ohm Non-reactive Dummy Load: 30W at 200 MHz
- Frequency Counter: >0.1 ppm accuracy at 200 MHz
- AF Signal Generator
- DC Voltmeter: high impedance
- VHF Sampling Coupler
- AF Dummy Load: 4 Ohms, 10 W
- Oscilloscope
- Spectrum Analyzer
- CP180 GPS/Chart Plotter
- GX5500S Marine Transceiver

Alignment Preparation & Precautions

A dummy load and inline wattmeter must be connected to the main antenna jack in all procedures that call for transmission. Correct alignment is not possible with an antenna.

After completing one step, read the following step to determine whether the same test equipment will be required. If not, remove the test equipment (except dummy load and wattmeter, if connected) before proceeding.

Correct alignment requires that the ambient temperature be the same as that of the transceiver and test equipment, and that this temperature be held constant between 68 °F and 86 °F (20 °C and 30 °C). When the transceiver is brought into the shop from hot or cold air it should be allowed some time for thermal equalization with the environment before alignment. If possible, alignments should be made with oscillator shields and circuit boards firmly affixed in place. Also, the test equipment must be thoroughly warmed up before beginning.

Note: Signal levels in dB referred to in this procedure are based on 0 dB μ = 0.5 μ V (closed circuit).

Alignment

Main Reference Frequency Adjustment

- Setup the test equipment as shown below.

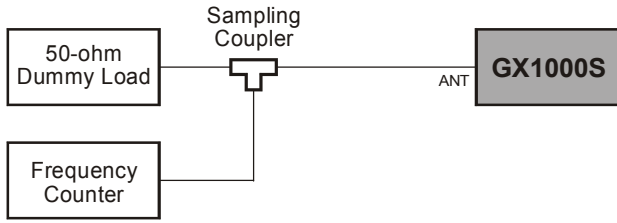

- Set the channel to CH16.
- Use the **[H/L]** key to set the transceiver to “LOW” power.
- With the **PTT** switch pressed, adjust **TC1001** so that the Frequency Counter reading is 156.800 MHz \pm 100 Hz.

Transmit Power Adjustment

- Setup the test equipment as shown below.

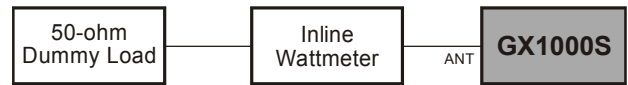

- Set the channel to CH16.
- Use the **[H/L]** key to set the transceiver to “HI” power.
- With the **PTT** switch pressed, adjust **VR1001** so that RF output power is 24 W \pm 0.3 W.
- Release the **PTT** switch, then set the transceiver to “LOW” power by the **[H/L]** key.
- With the **PTT** switch pressed, adjust **VR1002** so that RF output power is 0.8 W \pm 0.1 W.
- Release the **PTT** switch.

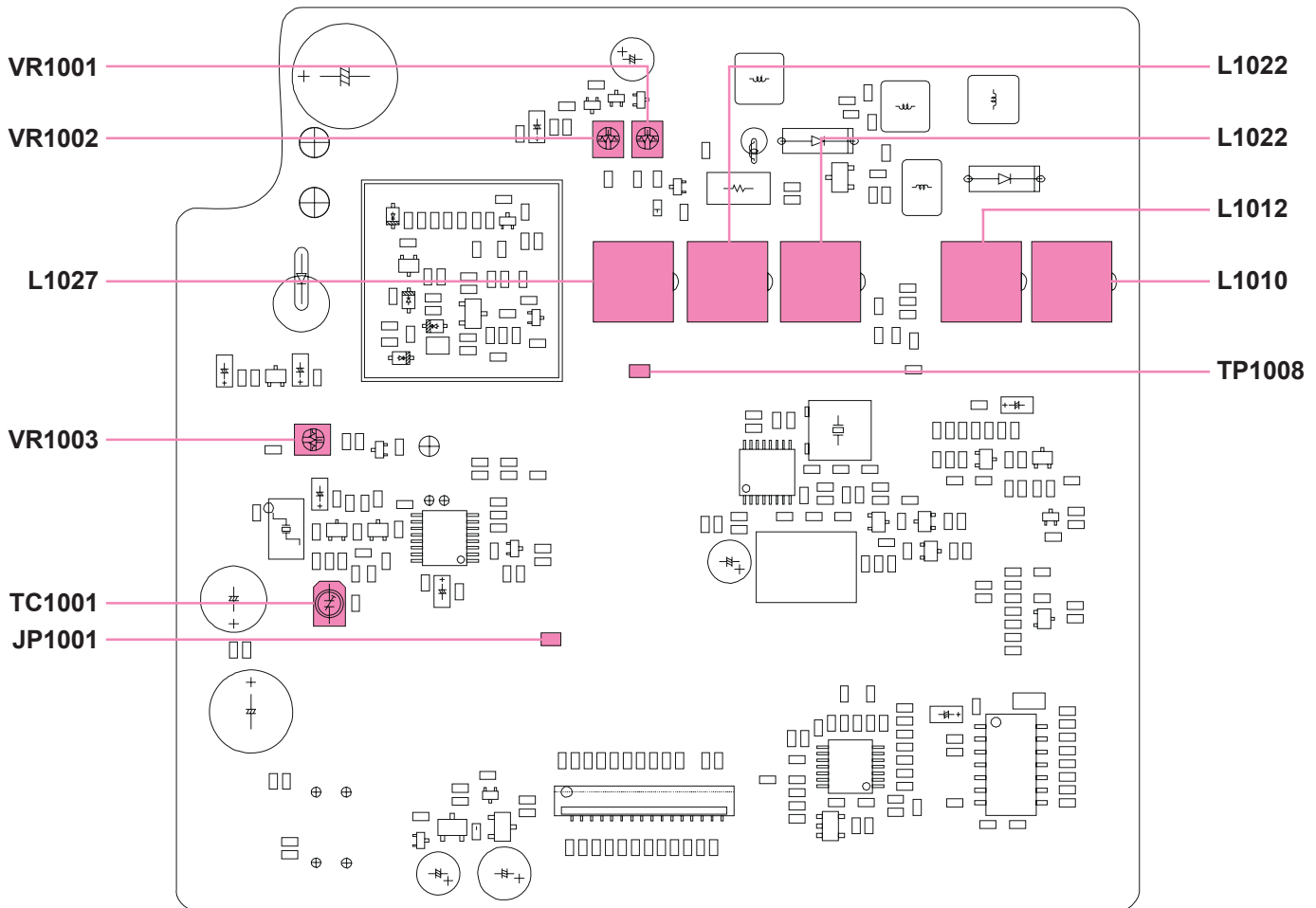

MAIN UNIT ALIGNMENT POINT

TX Deviation Adjustment

- ❑ Setup the test equipment as shown below.

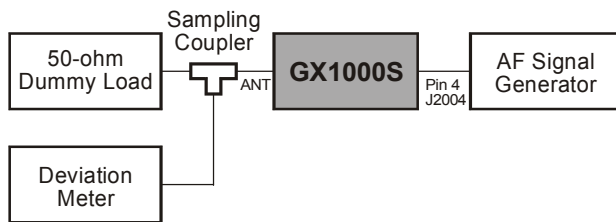

- ❑ Set the AF Signal Generator output to 200 mVrms at 1 kHz.
- ❑ Set the channel to CH16.
- ❑ With the **PTT** switch pressed, adjust **VR1003** so that the maximum deviation is 4.2 kHz \pm 0.1 kHz.
- ❑ Release the **PTT** switch.

Receiver Front-end Adjustment

- ❑ Setup the test equipment as shown below.



- ❑ Set the spectrum analyzer as shown below:
 - CENTER: 159.000 MHz
 - SPAN: 20.000 MHz
 - RBW, VBW: 30 kHz
 - SWP: 200 ms
- ❑ Adjust **L1010**, **L1012**, **L1022**, **L1026**, and **L1027** until the wave form shown in below is obtained.

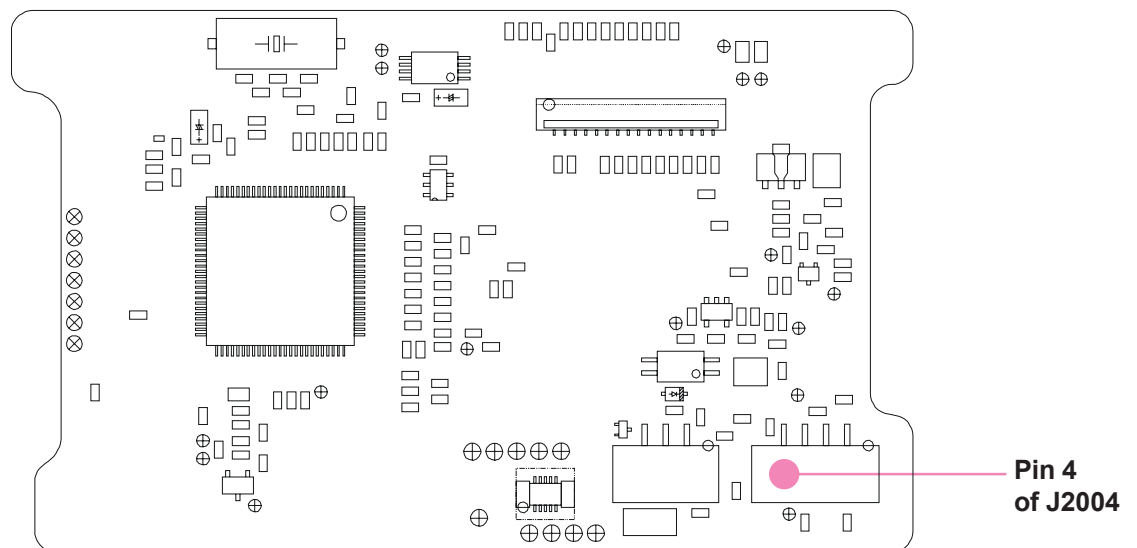
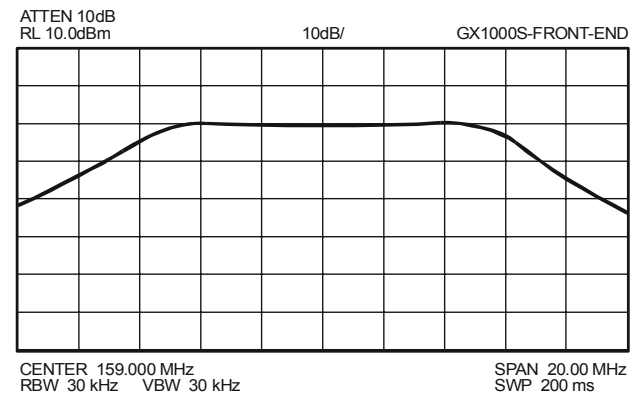

CNTL UNIT ALIGNMENT POINT

Alignment

Software Alignment/Confirmation Mode

Overview of Software Alignment Mode

The “Software Alignment Mode” has been build in the microprocessor in order to adjust and confirm the performance of transceiver.

The purpose is to adjust transceiver simply and to confirm the performance of transceiver smoothly.

Starting Software Alignment Mode

- ❑ Set the channel to CH16, then turn the **VOL** knob counter clockwise to turn off the radio.
- ❑ Short the TEST points (**JP1001**).
- ❑ Setup the test equipment as shown below.



- ❑ Turn the **VOL** knob clockwise to turn on the radio while press and holding the **[CALL(SET)MENU]** and **[DISTRESS]** keys. The LCD will be as shown in the illustration at the right.
- ❑ Press the **[SCAN(MEM)]** key to recall the Alignment Item “THxxx”.
- ❑ Set the RF Signal Generator output to 156.800 MHz, at a level of $-9\text{dB}\mu$, ± 3.0 kHz deviation with a 1 kHz audio tone.
- ❑ Press the **[WX]** key.
- ❑ Press the **[CALL(SET)MENU]** key to save the new setting.
- ❑ Press the **[SCAN(MEM)]** key to recall the Alignment Item “TIxxx”.
- ❑ Set the RF Signal Generator output to 156.800 MHz, at a level of $+3\text{dB}\mu$, ± 3.0 kHz deviation with a 1 kHz audio tone.
- ❑ Press the **[WX]** key.
- ❑ Press the **[CALL(SET)MENU]** key to save the new setting.



- ❑ Press the **[SCAN(MEM)]** key to recall the Alignment Item “SBxxx”.
- ❑ Set the RF Signal Generator output to 156.525 MHz, at a level of $-4\text{dB}\mu$, ± 3.0 kHz deviation with a 1 kHz audio tone.
- ❑ Press the **[WX]** key.
- ❑ Press the **[CALL(SET)MENU]** key to save the new setting.
- ❑ Press the **[SCAN]** key to recall the Alignment Item “VTxxx”.
- ❑ Press the **[WX]** key.
- ❑ Press the **[CALL(SET)MENU]** key to save the new setting.



This completes the Software Alignment Mode. To save all settings and exit, press and hold the **[DISTRESS]** key for one second. Turn the transceiver’s power off, then disconnect the Jumper from the TEST points (JP1001).

MAIN Unit

Note

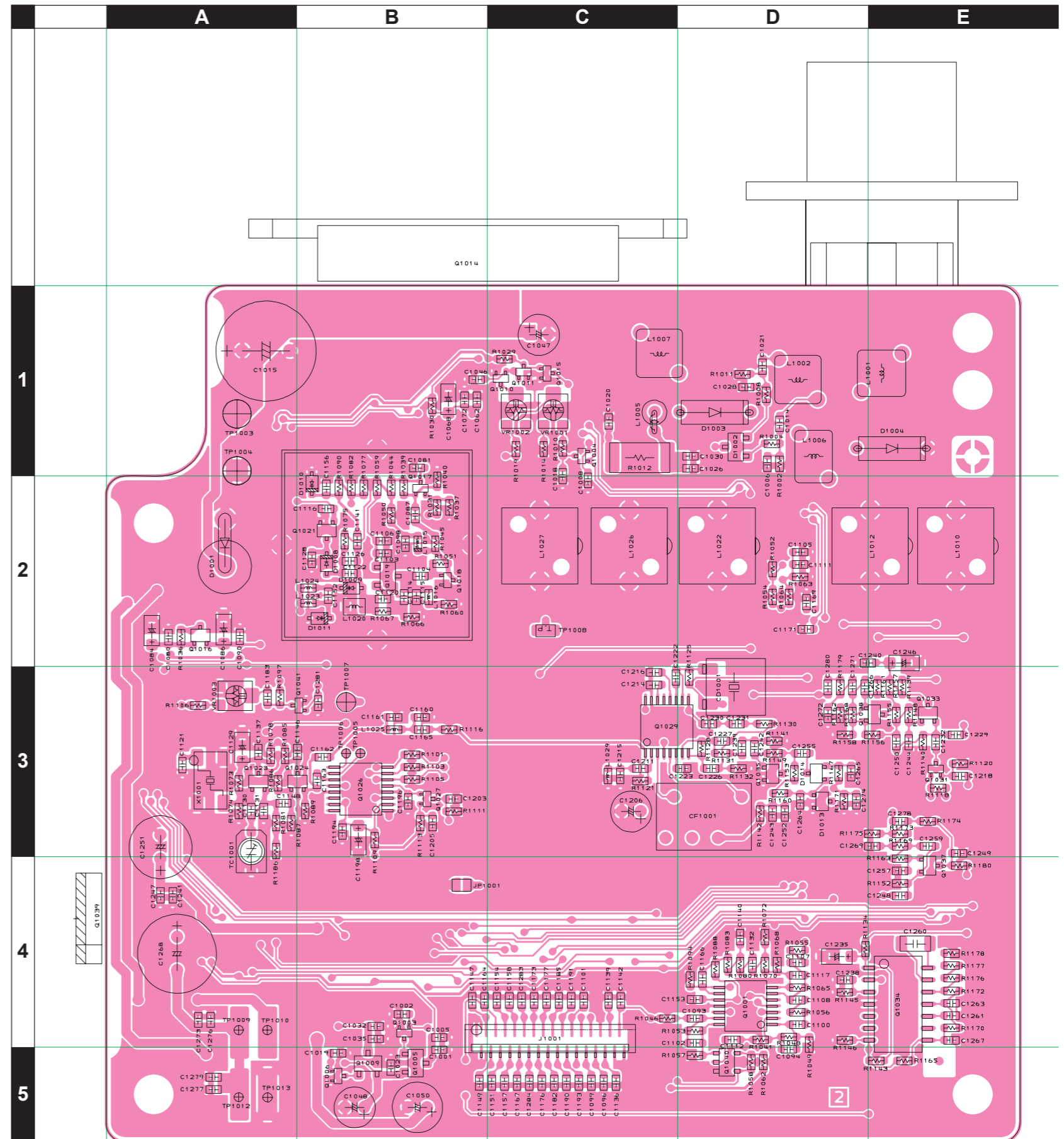
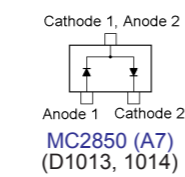
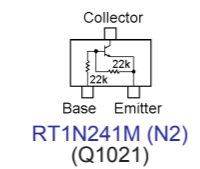
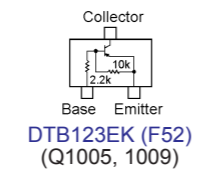
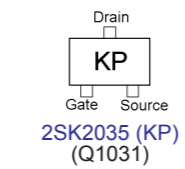
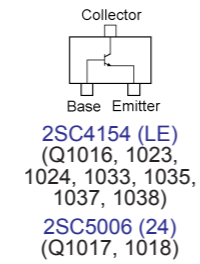
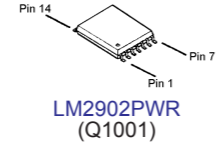
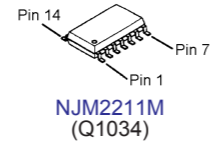
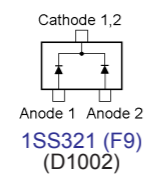
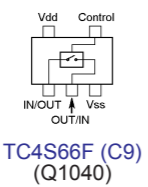
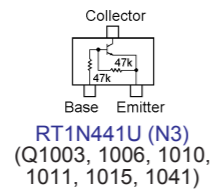
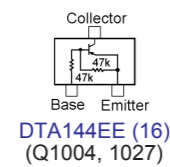
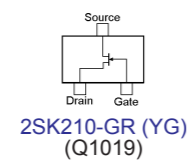
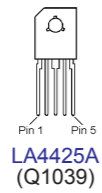
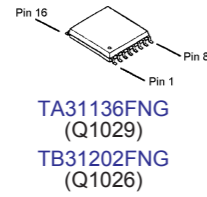
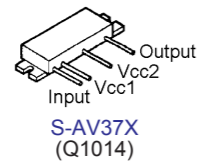

MAIN Unit

Parts Layout (Side B)

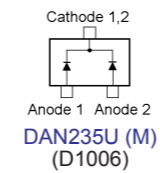
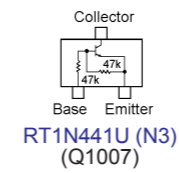
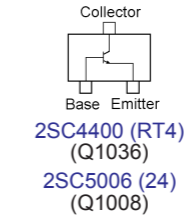
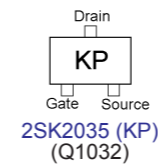
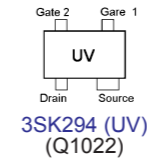
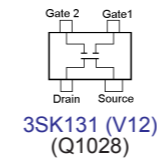
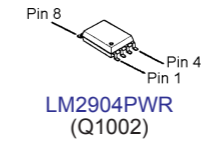
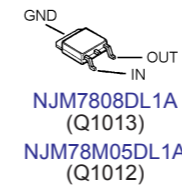
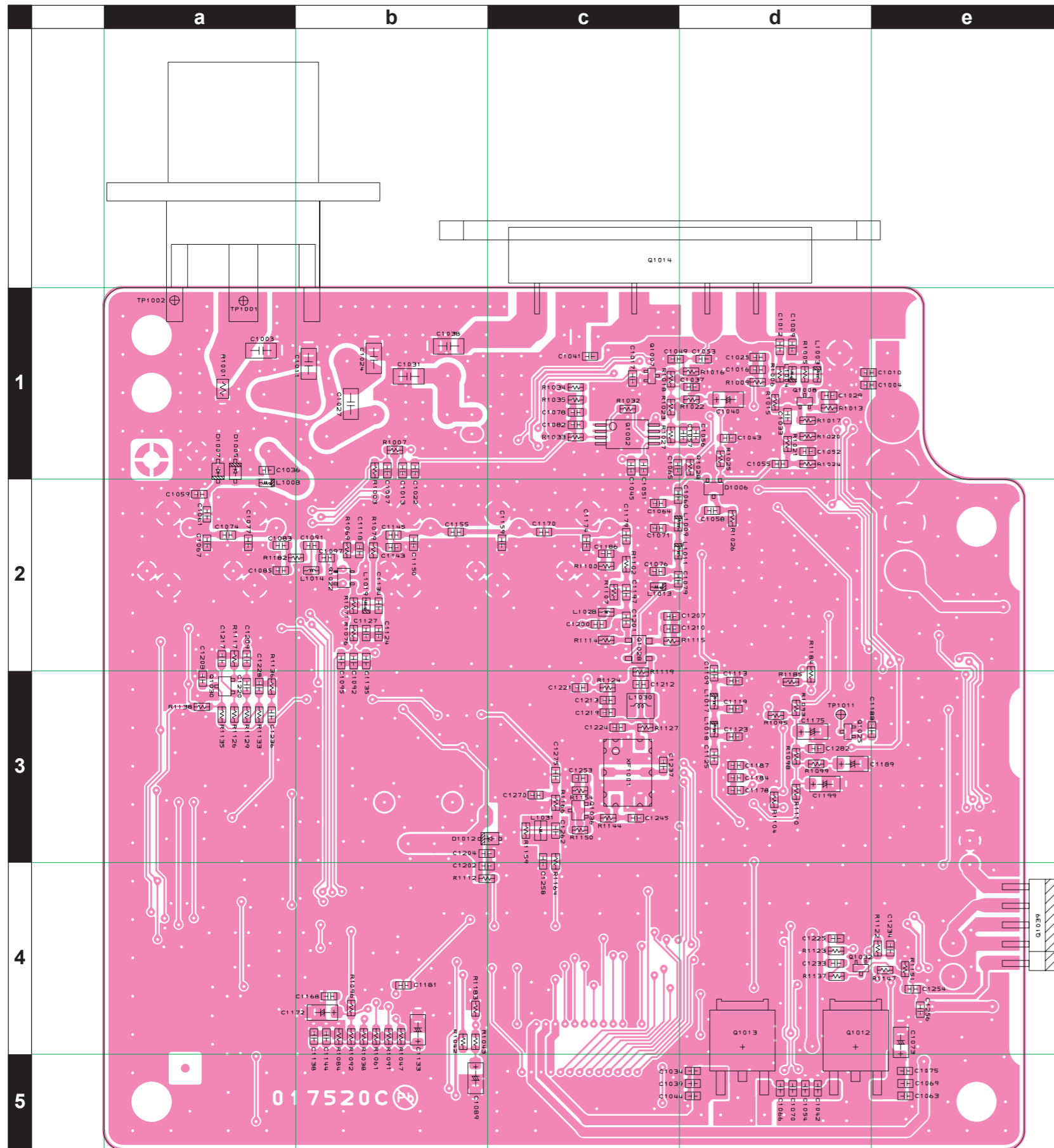

REF	DESCRIPTION	VALUE	V/W	TOL.	MFR'S DESIG	VXSTD P/N	VERS.	LOT	SIDE	LAY ADR	
P.C.B. with Components						CS1983701					
Printed Circuit Board						AM030N000	FR017520C		1-		
C 1001	CHIP CAP.	0.001uF	50V	B	GRM188B11H102KA01D	K22174821		1-	A	B5	
C 1002	CHIP CAP.	0.001uF	50V	B	GRM188B11H102KA01D	K22174821		1-	A	B4	
C 1003	CHIP CAP.	15pF	500V	CH	1206N150J501LT	K22278211		1-	B	a1	
C 1004	CHIP CAP.	0.001uF	50V	B	GRM188B11H102KA01D	K22174821		1-	B	d1	
C 1005	CHIP CAP.	0.01uF	50V	B	GRM188B11H103KA01D	K22174823		1-	A	B4	
C 1006	CHIP CAP.	4pF	50V	CH	GRM1882C1H4R0CZ01D	K22174205		1-	A	D1	
C 1007	CHIP CAP.	0.1uF	16V	B	GRM188B11C104KA01D	K22124805		1-	B	b1	
C 1010	CHIP CAP.	10pF	50V	CH	GRM1882C1H100JA01D	K22174211		1-	B	d1	
C 1011	CHIP CAP.	27pF	500V	CH	1206N270J501LT	K22278214		1-	B	b1	
C 1012	CHIP CAP.	6pF	50V	CH	GRM1882C1H6R0DZ01D	K22174207		1-	B	d1	
C 1013	CHIP CAP.	0.1uF	16V	B	GRM188B11C104KA01D	K22124805		1-	B	b1	
C 1014	CHIP CAP.	1pF	50V	CK	GRM1884C1H1R0CZ01D	K22174202		1-	A	D1	
C 1015	AL.ELECTRO.CAP.	1000uF	25V		SL025M102G20PKKKS00R	K40149072		1-	A	A1	
C 1016	CHIP CAP.	0.1uF	16V	B	GRM188B11C104KA01D	K22124805		1-	B	d1	
C 1019	CHIP CAP.	0.001uF	50V	B	GRM188B11H102KA01D	K22174821		1-	A	B5	
C 1020	CHIP CAP.	0.001uF	50V	B	GRM188B11H102KA01D	K22174821		1-	A	C1	
C 1021	CHIP CAP.	1pF	50V	CK	GRM1884C1H1R0CZ01D	K22174202		1-	A	D1	
C 1022	CHIP CAP.	0.001uF	50V	B	GRM188B11H102KA01D	K22174821		1-	B	b1	
C 1023	CHIP CAP.	10pF	50V	CH	GRM1882C1H100JA01D	K22174211		1-	A	B5	
C 1024	CHIP CAP.	18pF	500V	CH	1206N180J501LT	K22278212		1-	B	b1	
C 1025	CHIP CAP.	0.001uF	50V	B	GRM188B11H102KA01D	K22174821		1-	B	d1	
C 1027	CHIP CAP.	47pF	500V	CH	1206N470J501LT	K22278217		1-	B	b1	
C 1028	CHIP CAP.	3pF	50V	CJ	GRM1883C1H3R0CZ01D	K22174204		1-	A	D1	
C 1029	CHIP CAP.	0.001uF	50V	B	GRM188B11H102KA01D	K22174821		1-	B	d1	
C 1030	CHIP CAP.	0.001uF	50V	B	GRM188B11H102KA01D	K22174821		1-	A	D1	
C 1031	CHIP CAP.	22pF	500V	CH	1206N220J501LT	K22278213		1-	B	b1	
C 1032	CHIP CAP.	0.01uF	50V	B	GRM188B11H103KA01D	K22174823		1-	A	B4	
C 1033	CHIP CAP.	6pF	50V	CH	GRM1882C1H6R0DZ01D	K22174207		1-	B	d1	
C 1034	CHIP CAP.	10pF	50V	CH	GRM1882C1H100JA01D	K22174211		1-	B	d5	
C 1035	CHIP CAP.	0.001uF	50V	B	GRM188B11H102KA01D	K22174821		1-	A	B4	
C 1036	CHIP CAP.	15pF	50V	CH	GRM1882C1H150JA01D	K22174215		1-	B	a1	
C 1037	CHIP CAP.	0.001uF	50V	B	GRM188B11H102KA01D	K22174821		1-	B	d1	
C 1038	CHIP CAP.	22pF	500V	CH	1206N220J501LT	K22278213		1-	B	b1	
C 1039	CHIP CAP.	0.1uF	25V	F	GRM188F11E104ZA01D	K22145001		1-	B	d5	
C 1040	CHIP TA.CAP.	4.7uF	10V		F931A475MAA	K78100077		1-	B	d1	
C 1041	CHIP CAP.	0.001uF	50V	B	GRM188B11H102KA01D	K22174821		1-	B	c1	
C 1042	CHIP CAP.	10pF	50V	CH	GRM1882C1H100JA01D	K22174211		1-	B	d5	
C 1043	CHIP CAP.	0.001uF	50V	B	GRM188B11H102KA01D	K22174821		1-	B	d1	
C 1044	CHIP CAP.	0.001uF	50V	B	GRM188B11H102KA01D	K22174821		1-	B	d5	
C 1045	CHIP CAP.	0.22uF	10V	B	GRM188B11A224KA01D	K22104801		1-	B	c1	
C 1047	AL.ELECTRO.CAP.	10uF	25V		SS025M100C07PKKKS00R	K40149075		1-	A	C1	
C 1048	AL.ELECTRO.CAP.	10uF	25V		SS025M100C07PKKKS00R	K40149075		1-	A	B5	
C 1049	CHIP CAP.	10pF	50V	CH	GRM1882C1H100JA01D	K22174211		1-	B	c1	
C 1050	AL.ELECTRO.CAP.	47uF	25V		SL025M470D11PKKKS00R	K40149074		1-	A	B5	
C 1051	CHIP CAP.	0.001uF	50V	B	GRM188B11H102KA01D	K22174821		1-	B	c1	
C 1053	CHIP CAP.	0.001uF	50V	B	GRM188B11H102KA01D	K22174821		1-	B	d1	
C 1054	CHIP CAP.	0.001uF	50V	B	GRM188B11H102KA01D	K22174821		1-	B	d5	
C 1055	CHIP CAP.	0.001uF	50V	B	GRM188B11H102KA01D	K22174821		1-	B	d1	
C 1056	CHIP CAP.	0.22uF	10V	B	GRM188B11A224KA01D	K22104801		1-	B	d1	
C 1057	CHIP CAP.	0.1uF	16V	B	GRM188B11C104KA01D	K22124805		1-	B	d1	
C 1058	CHIP CAP.	0.001uF	50V	B	GRM188B11H102KA01D	K22174821		1-	B	d2	
C 1059	CHIP CAP.	47pF	50V	CH	GRM1882C1H470JA01D	K22174227		1-	B	a2	
C 1060	CHIP CAP.	0.001uF	50V	B	GRM188B11H102KA01D	K22174821		1-	B	c2	
C 1061	CHIP CAP.	9pF	50V	CH	GRM1882C1H9R0DZ01D	K22174210		1-	B	a2	
C 1062	CHIP CAP.	0.001uF	50V	B	GRM188B11H102KA01D	K22174821		1-	A	B1	
C 1063	CHIP CAP.	0.001uF	50V	B	GRM188B11H102KA01D	K22174821		1-	B	e5	
C 1064	CHIP CAP.	12pF	50V	CH	GRM1882C1H120JA01D	K22174213		1-	B	c2	
C 1065	CHIP CAP.	0.001uF	50V	B	GRM188B11H102KA01D	K22174821		1-	B	c1	
C 1066	CHIP CAP.	0.01uF	50V	B	GRM188B11H103KA01D	K22174823		1-	B	d5	
C 1067	CHIP CAP.	2pF	50V	CK	GRM1884C1H2R0CZ01D	K22174203		1-	B	a2	
C 1068	CHIP TA.CAP.	10uF	10V		F931A106MAA	K78100078		1-	A	B1	
C 1069	CHIP CAP.	0.01uF	50V	B	GRM188B11H103KA01D	K22174823		1-	B	e5	
C 1070	CHIP CAP.	0.001uF	50V	B	GRM188B11H102KA01D	K22174821		1-	B	d5	
C 1071	CHIP CAP.	39pF	50V	CH	GRM1882C1H390JA01D	K22174225		1-	B	c2	
C 1072	CHIP CAP.	0.1uF	16V	B	GRM188B11C104KA01D	K22124805		1-	A	B1	
C 1073	CHIP TA.CAP.	10uF	10V		F931A106MAA	K78100078		1-	B	e4	
C 1074	CHIP CAP.	0.75pF	50V	CK	GRM1884C1HR75CZ01D	K22174260		1-	B	a2	
C 1075	CHIP CAP.	10pF	50V	CH	GRM1882C1H100JA01D	K22174211		1-	B	e5	
C 1076	CHIP CAP.	12pF	50V	CH	GRM1882C1H120JA01D	K22174213		1-	B	c2	
C 1077	CHIP CAP.	6pF	50V	CH	GRM1882C1H6R0DZ01D	K22174207		1-	B	a2	
C 1078	CHIP CAP.	0.001uF	50V	B	GRM188B11H102KA01D	K22174821		1-	B	c1	

MAIN Unit

Parts List

REF	DESCRIPTION	VALUE	V/W	TOL.	MFR'S DESIG	VXSTD P/N	VERS.	LOT	SIDE	LAY ADR
C 1079	CHIP CAP.	7pF	50V	CH	GRM1882C1H7R0DZ01D	K22174208		1-	B	c2
C 1080	CHIP CAP.	0.001uF	50V	B	GRM188B11H102KA01D	K22174821		1-	A	A2
C 1081	CHIP CAP.	0.001uF	50V	B	GRM188B11H102KA01D	K22174821		1-	A	B1
C 1082	CHIP CAP.	0.01uF	50V	B	GRM188B11H103KA01D	K22174823		1-	B	c1
C 1083	CHIP CAP.	10pF	50V	CH	GRM1882C1H100JA01D	K22174211		1-	B	a2
C 1084	CHIP TA.CAP.	10uF	10V		F931A106MAA	K78100078		1-	A	A2
C 1086	CHIP TA.CAP.	10uF	10V		F931A106MAA	K78100078		1-	A	A2
C 1087	CHIP CAP.	1pF	50V	CK	GRM1884C1H1R0CZ01D	K22174202		1-	A	B2
C 1089	CHIP TA.CAP.	10uF	10V		F931A106MAA	K78100078		1-	B	b5
C 1090	CHIP CAP.	0.001uF	50V	B	GRM188B11H102KA01D	K22174821		1-	A	A2
C 1091	CHIP CAP.	0.001uF	50V	B	GRM188B11H102KA01D	K22174821		1-	B	b2
C 1092	CHIP CAP.	10pF	50V	CH	GRM1882C1H100JA01D	K22174211		1-	B	b2
C 1093	CHIP CAP.	0.0056uF	50V	B	GRM188B11H562KA01D	K22174818		1-	A	D4
C 1094	CHIP CAP.	15pF	50V	CH	GRM1882C1H150JA01D	K22174215		1-	A	D5
C 1095	CHIP CAP.	0.001uF	50V	B	GRM188B11H102KA01D	K22174821		1-	B	b2
C 1097	CHIP CAP.	0.001uF	50V	B	GRM188B11H102KA01D	K22174821		1-	B	b2
C 1098	CHIP CAP.	0.001uF	50V	B	GRM188B11H102KA01D	K22174821		1-	A	B2
C 1100	CHIP CAP.	1uF	6.3V	B	GRM188B10J105KA01D	K22084801		1-	A	D4
C 1102	CHIP CAP.	15pF	50V	CH	GRM1882C1H150JA01D	K22174215		1-	A	D4
C 1103	CHIP CAP.	0.001uF	50V	B	GRM188B11H102KA01D	K22174821		1-	A	B2
C 1104	CHIP CAP.	1pF	50V	CK	GRM1884C1H1R0CZ01D	K22174202		1-	A	B2
C 1105	CHIP CAP.	5pF	50V	CH	GRM1882C1H5R0CZ01D	K22174206		1-	A	D2
C 1106	CHIP CAP.	0.1uF	16V	B	GRM188B11C104KA01D	K22124805		1-	A	B2
C 1107	CHIP CAP.	0.1uF	16V	B	GRM188B11C104KA01D	K22124805		1-	A	D4
C 1108	CHIP CAP.	0.01uF	50V	B	GRM188B11H103KA01D	K22174823		1-	A	D4
C 1109	CHIP CAP.	6pF	50V	CH	GRM1882C1H6R0DZ01D	K22174207		1-	B	d3
C 1111	CHIP CAP.	0.001uF	50V	B	GRM188B11H102KA01D	K22174821		1-	A	D2
C 1112	CHIP CAP.	1uF	6.3V	B	GRM188B10J105KA01D	K22084801		1-	A	D4
C 1113	CHIP CAP.	56pF	50V	CH	GRM1882C1H560JA01D	K22174229		1-	B	d3
C 1114	CHIP CAP.	5pF	50V	CH	GRM1882C1H5R0CZ01D	K22174206		1-	A	B2
C 1115	CHIP CAP.	6pF	50V	CH	GRM1882C1H6R0DZ01D	K22174207		1-	A	B2
C 1117	CHIP CAP.	15pF	50V	CH	GRM1882C1H150JA01D	K22174215		1-	A	D4
C 1118	CHIP CAP.	0.001uF	50V	B	GRM188B11H102KA01D	K22174821		1-	B	b2
C 1119	CHIP CAP.	33pF	50V	CH	GRM1882C1H330JA01D	K22174223		1-	B	d3
C 1120	CHIP CAP.	0.001uF	50V	B	GRM188B11H102KA01D	K22174821		1-	A	B2
C 1121	CHIP CAP.	47pF	50V	CH	GRM1882C1H470JA01D	K22174227		1-	A	A3
C 1122	CHIP CAP.	6pF	50V	CH	GRM1882C1H6R0DZ01D	K22174207		1-	A	B2
C 1123	CHIP CAP.	10pF	50V	CH	GRM1882C1H100JA01D	K22174211		1-	B	d3
C 1125	CHIP CAP.	5pF	50V	CH	GRM1882C1H5R0CZ01D	K22174206		1-	B	d3
C 1127	CHIP CAP.	0.001uF	50V	B	GRM188B11H102KA01D	K22174821		1-	B	b2
C 1128	CHIP CAP.	0.001uF	50V	B	GRM188B11H102KA01D	K22174821		1-	A	B2
C 1129	CHIP TA.CAP.	10uF	10V		F931A106MAA	K78100078		1-	A	A3
C 1130	CHIP CAP.	27pF	50V	CH	GRM1882C1H270JA01D	K22174221		1-	A	A3
C 1131	CHIP CAP.	7pF	50V	CH	GRM1882C1H7R0DZ01D	K22174208		1-	A	A3
C 1132	CHIP CAP.	1uF	6.3V	B	GRM188B10J105KA01D	K22084801		1-	A	D4
C 1133	CHIP TA.CAP.	4.7uF	10V		F931A475MAA	K78100077		1-	B	b4
C 1134	CHIP CAP.	10pF	50V	CH	GRM1882C1H100JA01D	K22174211		1-	B	b2
C 1135	CHIP CAP.	0.001uF	50V	B	GRM188B11H102KA01D	K22174821		1-	B	b2
C 1137	CHIP CAP.	0.01uF	50V	B	GRM188B11H103KA01D	K22174823		1-	A	A3
C 1138	CHIP CAP.	1uF	6.3V	B	GRM188B10J105KA01D	K22084801		1-	B	b4
C 1140	CHIP CAP.	0.0068uF	50V	B	GRM188B11H682KA01D	K22174834		1-	A	D4
C 1141	CHIP CAP.	1pF	50V	CK	GRM1884C1H1R0CZ01D	K22174202		1-	A	B2
C 1144	CHIP CAP.	0.001uF	50V	B	GRM188B11H102KA01D	K22174821		1-	B	b4
C 1145	CHIP CAP.	4pF	50V	CH	GRM1882C1H4R0CZ01D	K22174205		1-	B	b2
C 1146	CHIP CAP.	0.01uF	50V	B	GRM188B11H103KA01D	K22174823		1-	A	B3
C 1148	CHIP CAP.	15pF	50V	CH	GRM1882C1H150JA01D	K22174215		1-	A	A3
C 1150	CHIP CAP.	4pF	50V	CH	GRM1882C1H4R0CZ01D	K22174205		1-	B	b2
C 1152	CHIP CAP.	15pF	50V	CH	GRM1882C1H150JA01D	K22174215		1-	A	B2
C 1153	CHIP CAP.	330pF	50V	B	GRM188B11H331KD01D	K22174820		1-	A	D4
C 1155	CHIP CAP.	0.5pF	50V	CK	GRM1884C1HR50CZ01D	K22174201		1-	B	b2
C 1159	CHIP CAP.	5pF	50V	CH	GRM1882C1H5R0CZ01D	K22174206		1-	B	c2
C 1160	CHIP CAP.	82pF	50V	CH	GRM1882C1H820JA01D	K22174233		1-	A	B3
C 1161	CHIP CAP.	82pF	50V	CH	GRM1882C1H820JA01D	K22174233		1-	A	B3
C 1162	CHIP CAP.	10pF	50V	CH	GRM1882C1H100JA01D	K22174211		1-	A	B3
C 1163	CHIP CAP.	100pF	50V	CH	GRM1882C1H101JA01D	K22174235		1-	A	B3
C 1165	CHIP CAP.	10pF	50V	CH	GRM1882C1H100JA01D	K22174211		1-	A	B3
C 1166	CHIP CAP.	0.0056uF	50V	B	GRM188B11H562KA01D	K22174818		1-	A	D4
C 1168	CHIP CAP.	0.001uF	50V	B	GRM188B11H102KA01D	K22174821		1-	B	b4
C 1169	CHIP CAP.	0.001uF	50V	B	GRM188B11H102KA01D	K22174821		1-	A	D2
C 1170	CHIP CAP.	0.5pF	50V	CK	GRM1884C1HR50CZ01D	K22174201		1-	B	c2
C 1171	CHIP CAP.	0.001uF	50V	B	GRM188B11H102KA01D	K22174821		1-	A	D2
C 1172	CHIP TA.CAP.	10uF	10V		F931A106MAA	K78100078		1-	B	b4
C 1174	CHIP CAP.	3pF	50V	CJ	GRM1883C1H3R0CZ01D	K22174204		1-	B	c2

MAIN Unit

Parts List

REF	DESCRIPTION	VALUE	V/W	TOL.	MFR'S DESIG	VXSTD P/N	VERS.	LOT	SIDE	LAY ADR
C 1175	CHIP TA.CAP.	0.33uF	35V		F931V334MAA	K78160054		1-	B	d3
C 1179	CHIP CAP.	3pF	50V	CJ	GRM1883C1H3R0CZ01D	K22174204		1-	B	c2
C 1181	CHIP CAP.	1uF	6.3V	B	GRM188B10J105KA01D	K22084801		1-	B	b4
C 1183	CHIP CAP.	1uF	6.3V	B	GRM188B10J105KA01D	K22084801		1-	A	A3
C 1189	CHIP TA.CAP.	2.2uF	6.3V		F930J225MAA	K78080093		1-	B	d3
C 1194	CHIP CAP.	0.001uF	50V	B	GRM188B11H102KA01D	K22174821		1-	A	B3
C 1196	CHIP CAP.	0.01uF	50V	B	GRM188B11H103KA01D	K22174823		1-	A	B3
C 1197	CHIP CAP.	22pF	50V	CH	GRM1882C1H220JA01D	K22174219		1-	B	c2
C 1198	CHIP TA.CAP.	10uF	10V		F931A106MAA	K78100078		1-	A	B3
C 1199	CHIP TA.CAP.	0.47uF	35V		F931V474MAA	K78160055		1-	B	d3
C 1200	CHIP CAP.	0.001uF	50V	B	GRM188B11H102KA01D	K22174821		1-	B	c2
C 1201	CHIP CAP.	0.001uF	50V	B	GRM188B11H102KA01D	K22174821		1-	B	c2
C 1202	CHIP CAP.	0.1uF	16V	B	GRM188B11C104KA01D	K22124805		1-	B	b4
C 1203	CHIP CAP.	0.01uF	50V	B	GRM188B11H103KA01D	K22174823		1-	A	B3
C 1204	CHIP CAP.	0.001uF	50V	B	GRM188B11H102KA01D	K22174821		1-	B	b3
C 1205	CHIP CAP.	0.01uF	50V	B	GRM188B11H103KA01D	K22174823		1-	A	B3
C 1206	AL.ELECTRO.CAP.	10uF	25V		SS025M100C07PKKKS00R	K40149075		1-	A	C3
C 1207	CHIP CAP.	0.001uF	50V	B	GRM188B11H102KA01D	K22174821		1-	B	c2
C 1210	CHIP CAP.	0.01uF	50V	B	GRM188B11H103KA01D	K22174823		1-	B	c2
C 1212	CHIP CAP.	33pF	50V	CH	GRM1882C1H330JA01D	K22174223		1-	B	c3
C 1213	CHIP CAP.	0.001uF	50V	B	GRM188B11H102KA01D	K22174821		1-	B	c3
C 1214	CHIP CAP.	0.1uF	16V	B	GRM188B11C104KA01D	K22124805		1-	A	C3
C 1216	CHIP CAP.	0.001uF	50V	B	GRM188B11H102KA01D	K22174821		1-	A	C3
C 1218	CHIP CAP.	1uF	6.3V	B	GRM188B10J105KA01D	K22084801		1-	A	E3
C 1219	CHIP CAP.	0.01uF	50V	B	GRM188B11H103KA01D	K22174823		1-	B	c3
C 1221	CHIP CAP.	0.001uF	50V	B	GRM188B11H102KA01D	K22174821		1-	B	c3
C 1222	CHIP CAP.	82pF	50V	CH	GRM1882C1H820JA01D	K22174233		1-	A	C3
C 1223	CHIP CAP.	0.1uF	16V	B	GRM188B11C104KA01D	K22124805		1-	A	D3
C 1224	CHIP CAP.	1pF	50V	CK	GRM1884C1H1R0CZ01D	K22174202		1-	B	c3
C 1226	CHIP CAP.	180pF	50V	CH	GRM1882C1H181JA01D	K22174241		1-	A	D3
C 1227	CHIP CAP.	180pF	50V	CH	GRM1882C1H181JA01D	K22174241		1-	A	D3
C 1229	CHIP CAP.	1uF	6.3V	B	GRM188B10J105KA01D	K22084801		1-	A	E3
C 1230	CHIP CAP.	0.1uF	16V	B	GRM188B11C104KA01D	K22124805		1-	A	D3
C 1231	CHIP CAP.	330pF	50V	B	GRM188B11H331KD01D	K22174820		1-	A	D3
C 1232	CHIP CAP.	0.1uF	16V	B	GRM188B11C104KA01D	K22124805		1-	A	E3
C 1233	CHIP CAP.	0.1uF	16V	B	GRM188B11C104KA01D	K22124805		1-	B	d4
C 1234	CHIP CAP.	1uF	6.3V	B	GRM188B10J105KA01D	K22084801		1-	B	e4
C 1235	CHIP TA.CAP.	10uF	10V		F931A106MAA	K78100078		1-	A	D4
C 1237	CHIP CAP.	7pF	50V	CH	GRM1882C1H7R0DZ01D	K22174208		1-	B	c3
C 1238	CHIP CAP.	0.1uF	16V	B	GRM188B11C104KA01D	K22124805		1-	A	D4
C 1239	CHIP CAP.	0.1uF	16V	B	GRM188B11C104KA01D	K22124805		1-	A	D3
C 1240	CHIP CAP.	0.1uF	16V	B	GRM188B11C104KA01D	K22124805		1-	A	E2
C 1241	CHIP CAP.	10pF	50V	CH	GRM1882C1H100JA01D	K22174211		1-	A	A4
C 1242	CHIP CAP.	330pF	50V	B	GRM188B11H331KD01D	K22174820		1-	A	D3
C 1243	CHIP CAP.	1uF	6.3V	B	GRM188B10J105KA01D	K22084801		1-	A	D3
C 1244	CHIP CAP.	0.001uF	50V	B	GRM188B11H102KA01D	K22174821		1-	A	E3
C 1245	CHIP CAP.	1pF	50V	CK	GRM1884C1H1R0CZ01D	K22174202		1-	B	c3
C 1246	CHIP TA.CAP.	10uF	10V		F931A106MAA	K78100078		1-	A	E2
C 1247	CHIP CAP.	0.001uF	50V	B	GRM188B11H102KA01D	K22174821		1-	A	A4
C 1248	CHIP CAP.	0.1uF	16V	B	GRM188B11C104KA01D	K22124805		1-	A	E4
C 1249	CHIP CAP.	0.01uF	50V	B	GRM188B11H103KA01D	K22174823		1-	A	E3
C 1250	CHIP CAP.	0.0027uF	50V	B	GRM188B11H272KA01D	K22174814		1-	A	E3
C 1251	AL.ELECTRO.CAP.	100uF	25V		SK025M101E11PKKKS00R	K40149073		1-	A	A4
C 1252	CHIP CAP.	0.001uF	50V	B	GRM188B11H102KA01D	K22174821		1-	A	D3
C 1253	CHIP CAP.	0.01uF	50V	B	GRM188B11H103KA01D	K22174823		1-	B	c3
C 1254	CHIP CAP.	1uF	6.3V	B	GRM188B10J105KA01D	K22084801		1-	B	e4
C 1255	CHIP CAP.	0.1uF	16V	B	GRM188B11C104KA01D	K22124805		1-	A	D3
C 1256	CHIP CAP.	0.001uF	50V	B	GRM188B11H102KA01D	K22174821		1-	B	e4
C 1257	CHIP CAP.	820pF	50V	B	GRM188B11H821KA01D	K22174808		1-	A	E4
C 1258	CHIP CAP.	0.01uF	50V	B	GRM188B11H103KA01D	K22174823		1-	B	c3
C 1259	CHIP CAP.	0.01uF	50V	B	GRM188B11H103KA01D	K22174823		1-	A	E3
C 1260	FILM CAP.	0.027uF	16V		ECHU1C273JX5	K57120041		1-	A	E4
C 1261	CHIP CAP.	0.1uF	16V	B	GRM188B11C104KA01D	K22124805		1-	A	E4
C 1262	CHIP CAP.	33pF	50V	CH	GRM1882C1H330JA01D	K22174223		1-	B	c3
C 1263	CHIP CAP.	0.0068uF	50V	B	GRM188B11H682KA01D	K22174834		1-	A	E4
C 1264	CHIP CAP.	0.001uF	50V	B	GRM188B11H102KA01D	K22174821		1-	A	D3
C 1265	CHIP CAP.	0.1uF	16V	B	GRM188B11C104KA01D	K22124805		1-	A	D3
C 1266	CHIP CAP.	0.047uF	25V	B	GRM188B11E473KA01D	K22144811		1-	A	D3
C 1267	CHIP CAP.	0.0022uF	50V	B	GRM188B11H222KA01D	K22174822		1-	A	E4
C 1268	AL.ELECTRO.CAP.	470uF	16V		SL016M471F12PKKKS00R	K40129102		1-	A	A4
C 1269	CHIP CAP.	0.0047uF	50V	B	GRM188B11H472KA01D	K22174833		1-	A	E3
C 1271	CHIP CAP.	0.056uF	16V	B	GRM188B11C563KA01D	K22124807		1-	A	D3
C 1272	CHIP CAP.	0.1uF	16V	B	GRM188B11C104KA01D	K22124805		1-	A	D3

MAIN Unit

Parts List

REF	DESCRIPTION	VALUE	V/W	TOL.	MFR'S DESIG	VXSTD P/N	VERS.	LOT	SIDE	LAY ADR
C 1273	CHIP CAP.	10pF	50V	CH	GRM1882C1H100JA01D	K22174211		1-	A	A4
C 1274	CHIP CAP.	0.033uF	16V	R	GRM188R11C333KA01D	K22124801		1-	A	D3
C 1275	CHIP CAP.	0.01uF	50V	B	GRM188B11H103KA01D	K22174823		1-	B	c3
C 1276	CHIP CAP.	0.001uF	50V	B	GRM188B11H102KA01D	K22174821		1-	A	A4
C 1277	CHIP CAP.	10pF	50V	CH	GRM1882C1H100JA01D	K22174211		1-	A	A5
C 1278	CHIP CAP.	0.1uF	16V	B	GRM188B11C104KA01D	K22124805		1-	A	E3
C 1279	CHIP CAP.	0.001uF	50V	B	GRM188B11H102KA01D	K22174821		1-	A	A5
C 1280	CHIP CAP.	1uF	6.3V	B	GRM188B10J105KA01D	K22084801		1-	A	D3
C 1283	CHIP CAP.	0.001uF	50V	B	GRM188B11H102KA01D	K22174821		1-	A	C4
C 1284	CHIP CAP.	0.001uF	50V	B	GRM188B11H102KA01D	K22174821		1-	A	C5
CD1001	CERAMIC DISC				CDBC450KCA524-R0	H7901340		1-	A	D3
CF1001	CERAMIC FILTER				LTM450EW	H3900574		1-	A	D3
D 1001	DIODE				1N5402	G2090800		1-	A	A2
D 1002	DIODE				1SS321(TE85R.F)	G2070076		1-	A	D1
D 1003	DIODE				L308CCB	G2090792		1-	A	D1
D 1004	DIODE				L308CCB	G2090792		1-	A	E1
D 1005	DIODE				HSU277TRF-E	G2070118		1-	B	a1
D 1006	DIODE				DAN235U TL	G2070176		1-	B	d2
D 1007	DIODE				HSU277TRF-E	G2070118		1-	B	a1
D 1008	DIODE				HSU277TRF-E	G2070118		1-	A	B2
D 1009	DIODE				HVU359 TRF-E	G2070452		1-	A	B2
D 1010	DIODE				1SV214(TPH2.F)	G2070356		1-	A	B2
D 1011	DIODE				HVU359 TRF-E	G2070452		1-	A	B2
D 1012	DIODE				BZT52-B5V6S	G2071212		1-	B	c3
D 1013	DIODE				MC2850-T111-1	G2070704		1-	A	D3
D 1014	DIODE				MC2850-T111-1	G2070704		1-	A	D3
J 1001	CONNECTOR				32FLT-SM2-TB(LF)(SN)	P1091258		1-	A	C4
L 1001	COIL A1				4.5T3.5D0.8UEW R	L0021149A		1-	A	E1
L 1002	COIL A1				4.5T3.5D0.8UEW R	L0021149A		1-	A	D1
L 1003	M.RFC	0.15uH			HK1608 R15J-T	L1690938		1-	B	d1
L 1004	M.RFC	0.15uH			HK1608 R15J-T	L1690938		1-	B	d1
L 1005	M.RFC	4.7uH			LAL03NA4R7K	L1190203		1-	A	C1
L 1006	COIL A1				3.5T4.0D0.8UEW R	L0022245		1-	A	D1
L 1007	COIL A1				4.5T3.5D0.8UEW R	L0021149A		1-	A	D1
L 1008	M.RFC	0.047uH			HK1608 47NJ-T	L1690524		1-	B	a2
L 1009	M.RFC	0.082uH			HK1608 82NJ-T	L1690527		1-	B	c2
L 1010	COIL	0.1uH			#E528SNAS-100075	L0190269		1-	A	E2
L 1011	M.RFC	0.082uH			HK1608 82NJ-T	L1690527		1-	B	c2
L 1012	COIL	0.1uH			#E528SNAS-100075	L0190269		1-	A	E2
L 1013	M.RFC	0.068uH			HK1608 68NJ-T	L1690526		1-	B	c2
L 1014	M.RFC	0.33uH			LK1608 R33K-T	L1690412		1-	B	b2
L 1015	M.RFC	0.1uH			HK1608 R10J-T	L1690528		1-	A	B2
L 1016	M.RFC	2.2uH			LK1608 2R2K-T	L1690634		1-	A	B2
L 1017	M.RFC	0.068uH			HK1608 68NJ-T	L1690526		1-	B	d3
L 1018	M.RFC	0.068uH			HK1608 68NJ-T	L1690526		1-	B	d3
L 1019	M.RFC	0.1uH			HK1608 R10J-T	L1690528		1-	B	b2
L 1020	M.RFC	0.068uH			C2012C-68NG-RA	L1690774		1-	A	B2
L 1022	COIL	0.15uH		2%	#E528SNAS-100076	L0190270		1-	A	D2
L 1023	M.RFC	2.2uH			LK1608 2R2K-T	L1690634		1-	A	B2
L 1024	M.RFC	2.2uH			LK1608 2R2K-T	L1690634		1-	A	B2
L 1025	M.RFC	0.47uH			LK1608 R47K-T	L1690414		1-	A	B3
L 1026	COIL	0.15uH			#E528SNAS-100076	L0190270		1-	A	C2
L 1027	COIL	0.15uH			#E528SNAS-100076	L0190270		1-	A	C2
L 1028	M.RFC	0.27uH			LK1608 R27K-T	L1690411		1-	B	c2
L 1030	CHIP COIL	1.5uH			C2520C-1R5K	L1690729		1-	B	c3
L 1031	M.RFC	1.5uH			LK2125 1R5K-T	L1690321		1-	B	c3
Q 1001	IC				LM2902PWR	G1094009		1-	A	D4
Q 1002	IC				LM2904PWR	G1094010		1-	B	c1
Q 1003	TRANSISTOR				RT1N441U-T11-1	G3070247		1-	A	B4
Q 1004	TRANSISTOR				DTA144EE TL	G3070074		1-	A	C1
Q 1005	TRANSISTOR				DTB123EK T146	G3070022		1-	A	B5
Q 1006	TRANSISTOR				RT1N441U-T11-1	G3070247		1-	A	B5
Q 1007	TRANSISTOR				RT1N441U-T11-1	G3070247		1-	B	c1
Q 1008	TRANSISTOR				2SC5006-T1	G3350068		1-	B	d1
Q 1009	TRANSISTOR				DTB123EK T146	G3070022		1-	A	B5
Q 1010	TRANSISTOR				RT1N441U-T11-1	G3070247		1-	A	C1
Q 1011	TRANSISTOR				RT1N441U-T11-1	G3070247		1-	A	C1
Q 1012	IC				NJM78M05DL1A-TE1	G1093660		1-	B	d4
Q 1013	IC				NJM7808DL1A-TE1	G1093802		1-	B	d4
Q 1014	IC				S-AV37A(VX.Q)	G1094559		1-	A	C1
Q 1015	TRANSISTOR				RT1N441U-T11-1	G3070247		1-	A	C1
Q 1016	TRANSISTOR				2SC4154-T11-1E	G3341548E		1-	A	A2
Q 1017	TRANSISTOR				2SC5006-T1	G3350068		1-	A	B2

MAIN Unit

Parts List

REF	DESCRIPTION	VALUE	V/W	TOL.	MFR'S DESIG	VXSTD P/N	VERS.	LOT	SIDE	LAY ADR
Q 1018	TRANSISTOR				2SC5006-T1	G3350068		1-	A	B2
Q 1019	FET				2SK210-GR(TE85R.F)	G3802107G		1-	A	B2
Q 1021	TRANSISTOR				RT1N241M-T11-1	G3070249		1-	A	B2
Q 1022	FET				3SK294(TE85L)	G4802948		1-	B	b2
Q 1023	TRANSISTOR				2SC4154-T11-1E	G3341548E		1-	A	A3
Q 1024	TRANSISTOR				2SC4154-T11-1E	G3341548E		1-	A	B3
Q 1026	IC				TB31202FNG(TAPE)	G1094103		1-	A	B3
Q 1027	TRANSISTOR				DTA144EE TL	G3070074		1-	A	B3
Q 1028	FET				3SK131-T2B V12	G4801317B		1-	B	c2
Q 1029	IC				TA31136FNG(EL)	G1091605		1-	A	C3
Q 1031	FET				2SK2035 TE85R	G3820357		1-	A	E3
Q 1032	FET				2SK2035 TE85R	G3820357		1-	B	d4
Q 1033	TRANSISTOR				2SC4154-T11-1E	G3341548E		1-	A	E3
Q 1034	IC				NJM2211M-TE1	G1092943		1-	A	E4
Q 1035	TRANSISTOR				2SC4154-T11-1E	G3341548E		1-	A	D3
Q 1036	TRANSISTOR				2SC4400-3-TL	G3344008C		1-	B	c3
Q 1037	TRANSISTOR				2SC4154-T11-1E	G3341548E		1-	A	E4
Q 1038	TRANSISTOR				2SC4154-T11-1E	G3341548E		1-	A	E3
Q 1039	IC				LA4425A	G1092241		1-	A	A4
Q 1040	IC				TC4S66F(TE85R.F)	G1090893		1-	A	D5
Q 1041	TRANSISTOR				RT1N441U-T11-1	G3070247		1-	A	B3
R 1001	CHIP RES.	56k	1/10W	5%	RMC1/10T 563J	J24205563		1-	B	a1
R 1002	CHIP RES.	4.7k	1/16W	5%	RMC1/16 472JATP	J24185472		1-	A	D1
R 1003	CHIP RES.	100k	1/16W	5%	RMC1/16 104JATP	J24185104		1-	B	b1
R 1004	CHIP RES.	0	1/16W	5%	RMC1/16 000JATP	J24185000		1-	A	D1
R 1005	CHIP RES.	1k	1/16W	5%	RMC1/16 102JATP	J24185102		1-	B	d1
R 1007	CHIP RES.	68k	1/16W	5%	RMC1/16 683JATP	J24185683		1-	B	b1
R 1008	CHIP RES.	0	1/16W	5%	RMC1/16 000JATP	J24185000		1-	A	D1
R 1009	CHIP RES.	100	1/16W	5%	RMC1/16 101JATP	J24185101		1-	B	d1
R 1010	CHIP RES.	0	1/16W	5%	RMC1/16 000JATP	J24185000		1-	A	C1
R 1011	CHIP RES.	4.7k	1/16W	5%	RMC1/16 472JATP	J24185472		1-	A	D1
R 1012	CHIP RES.	100	1W	5%	RMC1 101JTE	J24305101		1-	A	C1
R 1013	CHIP RES.	120	1/16W	5%	RMC1/16 121JATP	J24185121		1-	B	d1
R 1014	CHIP RES.	56k	1/16W	5%	RMC1/16 563JATP	J24185563		1-	A	C1
R 1015	CHIP RES.	4.7k	1/16W	5%	RMC1/16 472JATP	J24185472		1-	B	d1
R 1016	CHIP RES.	4.7k	1/16W	5%	RMC1/16 472JATP	J24185472		1-	B	d1
R 1017	CHIP RES.	2.2k	1/16W	5%	RMC1/16 222JATP	J24185222		1-	B	d1
R 1018	CHIP RES.	470	1/16W	5%	RMC1/16 471JATP	J24185471		1-	B	c1
R 1019	CHIP RES.	1k	1/16W	5%	RMC1/16 102JATP	J24185102		1-	A	C1
R 1021	CHIP RES.	22	1/16W	5%	RMC1/16 220JATP	J24185220		1-	B	d1
R 1022	CHIP RES.	220	1/16W	5%	RMC1/16 221JATP	J24185221		1-	B	d1
R 1023	CHIP RES.	100	1/16W	5%	RMC1/16 101JATP	J24185101		1-	B	c1
R 1025	CHIP RES.	2.2k	1/16W	5%	RMC1/16 222JATP	J24185222		1-	B	d1
R 1026	CHIP RES.	2.2k	1/16W	5%	RMC1/16 222JATP	J24185222		1-	B	d2
R 1027	CHIP RES.	470k	1/16W	5%	RMC1/16 474JATP	J24185474		1-	B	c1
R 1028	CHIP RES.	2.2k	1/16W	5%	RMC1/16 222JATP	J24185222		1-	B	d1
R 1029	CHIP RES.	2.2k	1/16W	5%	RMC1/16 222JATP	J24185222		1-	A	C1
R 1030	CHIP RES.	47	1/16W	5%	RMC1/16 470JATP	J24185470		1-	A	B1
R 1031	CHIP RES.	47	1/16W	5%	RMC1/16 470JATP	J24185470		1-	A	B2
R 1032	CHIP RES.	10k	1/16W	5%	RMC1/16 103JATP	J24185103		1-	B	c1
R 1033	CHIP RES.	10k	1/16W	5%	RMC1/16 103JATP	J24185103		1-	B	c1
R 1034	CHIP RES.	22k	1/16W	5%	RMC1/16 223JATP	J24185223		1-	B	c1
R 1035	CHIP RES.	22k	1/16W	5%	RMC1/16 223JATP	J24185223		1-	B	c1
R 1036	CHIP RES.	1k	1/16W	5%	RMC1/16 102JATP	J24185102		1-	A	A2
R 1037	CHIP RES.	220	1/16W	5%	RMC1/16 221JATP	J24185221		1-	A	B2
R 1038	CHIP RES.	470k	1/16W	5%	RMC1/16 474JATP	J24185474		1-	B	b4
R 1039	CHIP RES.	2.2k	1/16W	5%	RMC1/16 222JATP	J24185222		1-	A	B2
R 1040	CHIP RES.	3.3k	1/16W	5%	RMC1/16 332JATP	J24185332		1-	A	B2
R 1041	CHIP RES.	220k	1/16W	5%	RMC1/16 224JATP	J24185224		1-	A	D4
R 1042	CHIP RES.	470	1/16W	5%	RMC1/16 471JATP	J24185471		1-	B	b4
R 1043	CHIP RES.	10k	1/16W	5%	RMC1/16 103JATP	J24185103		1-	B	b4
R 1044	CHIP RES.	18	1/16W	5%	RMC1/16 180JATP	J24185180		1-	A	B2
R 1045	CHIP RES.	22	1/16W	5%	RMC1/16 220JATP	J24185220		1-	A	B2
R 1046	CHIP RES.	5.6k	1/16W	5%	RMC1/16 562JATP	J24185562		1-	A	C4
R 1047	CHIP RES.	470k	1/16W	5%	RMC1/16 474JATP	J24185474		1-	B	b4
R 1048	CHIP RES.	220k	1/16W	5%	RMC1/16 224JATP	J24185224		1-	A	D4
R 1049	CHIP RES.	2.2k	1/16W	5%	RMC1/16 222JATP	J24185222		1-	A	D4
R 1050	CHIP RES.	100	1/16W	5%	RMC1/16 101JATP	J24185101		1-	A	B2
R 1051	CHIP RES.	47k	1/16W	5%	RMC1/16 473JATP	J24185473		1-	A	B2
R 1052	CHIP RES.	22k	1/16W	5%	RMC1/16 223JATP	J24185223		1-	A	D2
R 1053	CHIP RES.	180k	1/16W	5%	RMC1/16 184JATP	J24185184		1-	A	D4
R 1054	CHIP RES.	33k	1/16W	5%	RMC1/16 333JATP	J24185333		1-	A	D2
R 1055	CHIP RES.	270k	1/16W	5%	RMC1/16 274JATP	J24185274		1-	A	D4

MAIN Unit

Parts List

REF	DESCRIPTION	VALUE	V/W	TOL.	MFR'S DESIG	VXSTD P/N	VERS.	LOT	SIDE	LAY ADR
R 1056	CHIP RES.	47k	1/16W	5%	RMC1/16 473JATP	J24185473		1-	A	D4
R 1057	CHIP RES.	2.2k	1/16W	5%	RMC1/16 222JATP	J24185222		1-	A	D5
R 1058	CHIP RES.	47k	1/16W	5%	RMC1/16 473JATP	J24185473		1-	A	D5
R 1059	CHIP RES.	100	1/16W	5%	RMC1/16 101JATP	J24185101		1-	A	B2
R 1060	CHIP RES.	22	1/16W	5%	RMC1/16 220JATP	J24185220		1-	A	B2
R 1061	CHIP RES.	470k	1/16W	5%	RMC1/16 474JATP	J24185474		1-	B	b4
R 1062	CHIP RES.	100	1/16W	5%	RMC1/16 101JATP	J24185101		1-	A	D5
R 1063	CHIP RES.	47k	1/16W	5%	RMC1/16 473JATP	J24185473		1-	A	D2
R 1064	CHIP RES.	10k	1/16W	5%	RMC1/16 103JATP	J24185103		1-	A	D2
R 1065	CHIP RES.	330k	1/16W	5%	RMC1/16 334JATP	J24185334		1-	A	D4
R 1066	CHIP RES.	22k	1/16W	5%	RMC1/16 223JATP	J24185223		1-	A	B2
R 1069	CHIP RES.	100	1/16W	5%	RMC1/16 101JATP	J24185101		1-	B	b2
R 1070	CHIP RES.	1k	1/16W	5%	RMC1/16 102JATP	J24185102		1-	A	D4
R 1071	CHIP RES.	2.2k	1/16W	5%	RMC1/16 222JATP	J24185222		1-	B	b2
R 1072	CHIP RES.	1k	1/16W	5%	RMC1/16 102JATP	J24185102		1-	A	D4
R 1073	CHIP RES.	22k	1/16W	5%	RMC1/16 223JATP	J24185223		1-	A	A3
R 1074	CHIP RES.	22k	1/16W	5%	RMC1/16 223JATP	J24185223		1-	A	A3
R 1075	CHIP RES.	4.7k	1/16W	5%	RMC1/16 472JATP	J24185472		1-	A	B2
R 1076	CHIP RES.	47	1/16W	5%	RMC1/16 470JATP	J24185470		1-	B	b2
R 1077	CHIP RES.	47k	1/16W	5%	RMC1/16 473JATP	J24185473		1-	A	B2
R 1078	CHIP RES.	100	1/16W	5%	RMC1/16 101JATP	J24185101		1-	A	A3
R 1079	CHIP RES.	0	1/16W	5%	RMC1/16 000JATP	J24185000		1-	B	b2
R 1080	CHIP RES.	8.2k	1/16W	5%	RMC1/16 822JATP	J24185822		1-	A	D4
R 1081	CHIP RES.	1.2k	1/16W	5%	RMC1/16 122JATP	J24185122		1-	A	A3
R 1082	CHIP RES.	47k	1/16W	5%	RMC1/16 473JATP	J24185473		1-	A	B2
R 1083	CHIP RES.	39k	1/16W	5%	RMC1/16 393JATP	J24185393		1-	A	D4
R 1084	CHIP RES.	10k	1/16W	5%	RMC1/16 103JATP	J24185103		1-	B	b4
R 1085	CHIP RES.	100	1/16W	5%	RMC1/16 101JATP	J24185101		1-	A	A3
R 1086	CHIP RES.	22k	1/16W	5%	RMC1/16 223JATP	J24185223		1-	A	A3
R 1087	CHIP RES.	22k	1/16W	5%	RMC1/16 223JATP	J24185223		1-	A	A3
R 1088	CHIP RES.	39k	1/16W	5%	RMC1/16 393JATP	J24185393		1-	A	D4
R 1089	CHIP RES.	150	1/16W	5%	RMC1/16 151JATP	J24185151		1-	A	B3
R 1090	CHIP RES.	10k	1/16W	5%	RMC1/16 103JATP	J24185103		1-	A	B2
R 1091	CHIP RES.	470k	1/16W	5%	RMC1/16 474JATP	J24185474		1-	B	b4
R 1092	CHIP RES.	18k	1/16W	5%	RMC1/16 183JATP	J24185183		1-	B	b4
R 1093	CHIP RES.	100	1/16W	5%	RMC1/16 101JATP	J24185101		1-	B	d3
R 1094	CHIP RES.	1k	1/16W	5%	RMC1/16 102JATP	J24185102		1-	A	D4
R 1095	CHIP RES.	100k	1/16W	5%	RMC1/16 104JATP	J24185104		1-	B	d3
R 1096	CHIP RES.	100	1/16W	5%	RMC1/16 101JATP	J24185101		1-	B	b4
R 1097	CHIP RES.	10k	1/16W	5%	RMC1/16 103JATP	J24185103		1-	A	A3
R 1098	CHIP RES.	1.5k	1/16W	5%	RMC1/16 152JATP	J24185152		1-	B	d3
R 1099	CHIP RES.	1.8k	1/16W	5%	RMC1/16 182JATP	J24185182		1-	B	d3
R 1100	CHIP RES.	680	1/16W	5%	RMC1/16 681JATP	J24185681		1-	B	c2
R 1101	CHIP RES.	100	1/16W	5%	RMC1/16 101JATP	J24185101		1-	A	B3
R 1102	CHIP RES.	10	1/16W	5%	RMC1/16 100JATP	J24185100		1-	B	c2
R 1103	CHIP RES.	100	1/16W	5%	RMC1/16 101JATP	J24185101		1-	A	B3
R 1105	CHIP RES.	100	1/16W	5%	RMC1/16 101JATP	J24185101		1-	A	B3
R 1106	CHIP RES.	47k	1/16W	5%	RMC1/16 473JATP	J24185473		1-	A	A3
R 1107	CHIP RES.	680	1/16W	5%	RMC1/16 681JATP	J24185681		1-	B	c2
R 1109	CHIP RES.	47	1/16W	5%	RMC1/16 470JATP	J24185470		1-	A	B3
R 1110	CHIP RES.	0	1/16W	5%	RMC1/16 000JATP	J24185000		1-	B	d3
R 1111	CHIP RES.	10k	1/16W	5%	RMC1/16 103JATP	J24185103		1-	A	B3
R 1112	CHIP RES.	220	1/16W	5%	RMC1/16 221JATP	J24185221		1-	B	b4
R 1113	CHIP RES.	47	1/16W	5%	RMC1/16 470JATP	J24185470		1-	A	B3
R 1114	CHIP RES.	10k	1/16W	5%	RMC1/16 103JATP	J24185103		1-	B	c2
R 1115	CHIP RES.	82	1/16W	5%	RMC1/16 820JATP	J24185820		1-	B	c2
R 1116	CHIP RES.	0	1/16W	5%	RMC1/16 000JATP	J24185000		1-	A	B3
R 1118	CHIP RES.	47k	1/16W	5%	RMC1/16 473JATP	J24185473		1-	A	E3
R 1119	CHIP RES.	4.7k	1/16W	5%	RMC1/16 472JATP	J24185472		1-	B	c3
R 1120	CHIP RES.	47k	1/16W	5%	RMC1/16 473JATP	J24185473		1-	A	E3
R 1121	CHIP RES.	100k	1/16W	5%	RMC1/16 104JATP	J24185104		1-	A	C3
R 1122	CHIP RES.	22k	1/16W	5%	RMC1/16 223JATP	J24185223		1-	B	e4
R 1123	CHIP RES.	0	1/16W	5%	RMC1/16 000JATP	J24185000		1-	B	d4
R 1124	CHIP RES.	100	1/16W	5%	RMC1/16 101JATP	J24185101		1-	B	c3
R 1125	CHIP RES.	1.8k	1/16W	5%	RMC1/16 182JATP	J24185182		1-	A	D3
R 1127	CHIP RES.	1k	1/16W	5%	RMC1/16 102JATP	J24185102		1-	B	c3
R 1128	CHIP RES.	270k	1/16W	5%	RMC1/16 274JATP	J24185274		1-	A	D3
R 1130	CHIP RES.	1.8k	1/16W	5%	RMC1/16 182JATP	J24185182		1-	A	D3
R 1131	CHIP RES.	0	1/16W	5%	RMC1/16 000JATP	J24185000		1-	A	D3
R 1132	CHIP RES.	1.8k	1/16W	5%	RMC1/16 182JATP	J24185182		1-	A	D3
R 1134	CHIP RES.	100	1/16W	5%	RMC1/16 101JATP	J24185101		1-	A	D4
R 1137	CHIP RES.	180k	1/16W	5%	RMC1/16 184JATP	J24185184		1-	B	d4
R 1139	CHIP RES.	1k	1/16W	5%	RMC1/16 102JATP	J24185102		1-	A	E3

MAIN Unit

Parts List

REF	DESCRIPTION	VALUE	V/W	TOL.	MFR'S DESIG	VXSTD P/N	VERS.	LOT	SIDE	LAY ADR
R 1140	CHIP RES.	2.2k	1/16W	5%	RMC1/16 222JATP	J24185222		1-	A	E3
R 1142	CHIP RES.	100	1/16W	5%	RMC1/16 101JATP	J24185101		1-	A	D3
R 1143	CHIP RES.	10k	1/16W	5%	RMC1/16 103JATP	J24185103		1-	A	E5
R 1144	CHIP RES.	2.7k	1/16W	5%	RMC1/16 272JATP	J24185272		1-	B	c3
R 1145	CHIP RES.	470k	1/16W	5%	RMC1/16 474JATP	J24185474		1-	A	D4
R 1146	CHIP RES.	100k	1/16W	5%	RMC1/16 104JATP	J24185104		1-	A	D4
R 1147	CHIP RES.	10k	1/16W	5%	RMC1/16 103JATP	J24185103		1-	B	e4
R 1148	CHIP RES.	22k	1/16W	5%	RMC1/16 223JATP	J24185223		1-	A	E3
R 1149	CHIP RES.	560k	1/16W	5%	RMC1/16 564JATP	J24185564		1-	A	D3
R 1150	CHIP RES.	470k	1/16W	5%	RMC1/16 474JATP	J24185474		1-	B	c3
R 1151	CHIP RES.	18k	1/16W	5%	RMC1/16 183JATP	J24185183		1-	B	e4
R 1152	CHIP RES.	2.2k	1/16W	5%	RMC1/16 222JATP	J24185222		1-	A	E4
R 1153	CHIP RES.	3.3k	1/16W	5%	RMC1/16 332JATP	J24185332		1-	A	D3
R 1154	CHIP RES.	220	1/16W	5%	RMC1/16 221JATP	J24185221		1-	B	c3
R 1155	CHIP RES.	22k	1/16W	5%	RMC1/16 223JATP	J24185223		1-	A	E3
R 1157	CHIP RES.	1k	1/16W	5%	RMC1/16 102JATP	J24185102		1-	A	E3
R 1158	CHIP RES.	560	1/16W	5%	RMC1/16 561JATP	J24185561		1-	A	D3
R 1159	CHIP RES.	4.7k	1/16W	5%	RMC1/16 472JATP	J24185472		1-	B	c3
R 1160	CHIP RES.	10k	1/16W	5%	RMC1/16 103JATP	J24185103		1-	A	D3
R 1161	CHIP RES.	120k	1/16W	5%	RMC1/16 124JATP	J24185124		1-	A	E3
R 1162	CHIP RES.	100k	1/16W	5%	RMC1/16 104JATP	J24185104		1-	A	D3
R 1163	CHIP RES.	22k	1/16W	5%	RMC1/16 223JATP	J24185223		1-	A	E4
R 1164	CHIP RES.	100	1/16W	5%	RMC1/16 101JATP	J24185101		1-	B	c3
R 1165	CHIP RES.	470k	1/16W	5%	RMC1/16 474JATP	J24185474		1-	A	E5
R 1166	CHIP RES.	0	1/16W	5%	RMC1/16 000JATP	J24185000		1-	B	c3
R 1167	CHIP RES.	10k	1/16W	5%	RMC1/16 103JATP	J24185103		1-	A	D3
R 1168	CHIP RES.	4.7k	1/16W	5%	RMC1/16 472JATP	J24185472		1-	A	D3
R 1169	CHIP RES.	22k	1/16W	5%	RMC1/16 223JATP	J24185223		1-	A	E3
R 1170	CHIP RES.	100k	1/16W	5%	RMC1/16 104JATP	J24185104		1-	A	E4
R 1171	CHIP RES.	100k	1/16W	5%	RMC1/16 104JATP	J24185104		1-	A	D3
R 1172	CHIP RES.	47k	1/16W	5%	RMC1/16 473JATP	J24185473		1-	A	E4
R 1173	CHIP RES.	22k	1/16W	5%	RMC1/16 223JATP	J24185223		1-	A	E3
R 1174	CHIP RES.	33k	1/16W	5%	RMC1/16 333JATP	J24185333		1-	A	E3
R 1175	CHIP RES.	56k	1/16W	5%	RMC1/16 563JATP	J24185563		1-	A	E3
R 1176	CHIP RES.	10k	1/16W	1%	RMC1/16 103FTP	J24183103		1-	A	E4
R 1177	CHIP RES.	10k	1/16W	1%	RMC1/16 103FTP	J24183103		1-	A	E4
R 1178	CHIP RES.	1k	1/16W	1%	RMC1/16 102FTP	J24183102		1-	A	E4
R 1179	CHIP RES.	8.2k	1/16W	5%	RMC1/16 822JATP	J24185822		1-	A	D3
R 1180	CHIP RES.	100	1/16W	5%	RMC1/16 101JATP	J24185101		1-	A	E4
R 1182	CHIP RES.	0	1/16W	5%	RMC1/16 000JATP	J24185000		1-	B	b2
R 1183	CHIP RES.	22k	1/16W	5%	RMC1/16 223JATP	J24185223		1-	B	b4
R 1184	CHIP RES.	1k	1/16W	5%	RMC1/16 102JATP	J24185102		1-	B	d3
R 1185	CHIP RES.	1k	1/16W	5%	RMC1/16 102JATP	J24185102		1-	B	d3
R 1186	CHIP RES.	0	1/16W	5%	RMC1/16 000JATP	J24185000		1-	A	A3
TC1001	TRIMMER CAP.	20pF			ECR-KN020E61X	K91000213		1-	A	A3
TP1008	CHECK TERMINAL				RCT00000C	Q5000103		1-	A	C2
VR1001	POT.	50k			EVN-5ESX50B54	J51811503		1-	A	C1
VR1002	POT.	10k			EVN-5ESX50B14	J51811103		1-	A	C1
VR1003	POT.	100k			EVN-5ESX50B15	J51811104		1-	A	A3
X 1001	XTAL TOP-B	21.85MHz			21.85000MHZ	H0103270		1-	A	A3
XF1001	XTAL FILTER				21S13B	H1102353		1-	B	c3
	SHIELD CASE VCO					RA0418500		1-		

MAIN Unit

Note

CNTL Unit

Parts Layout

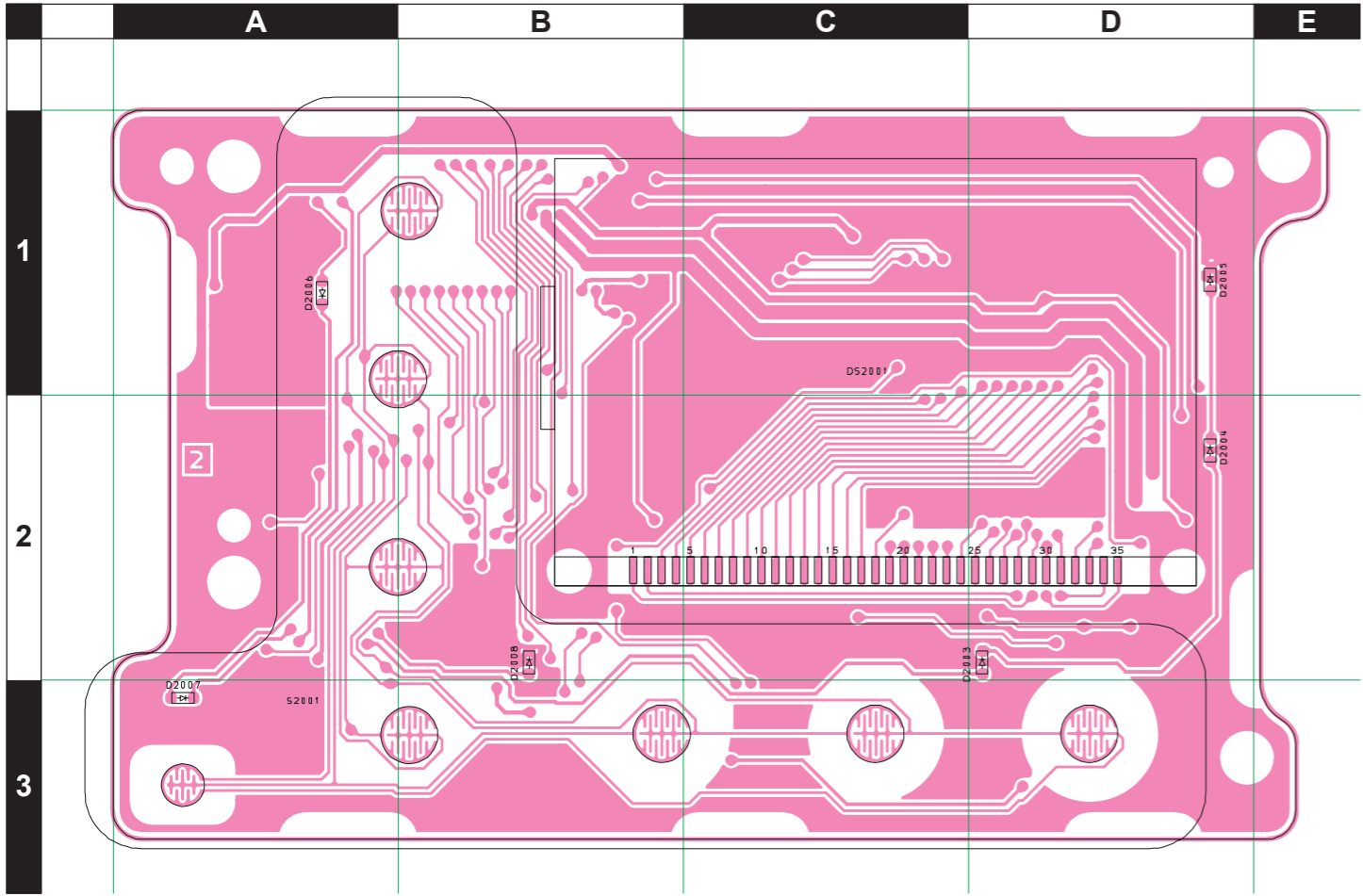

(Side A)

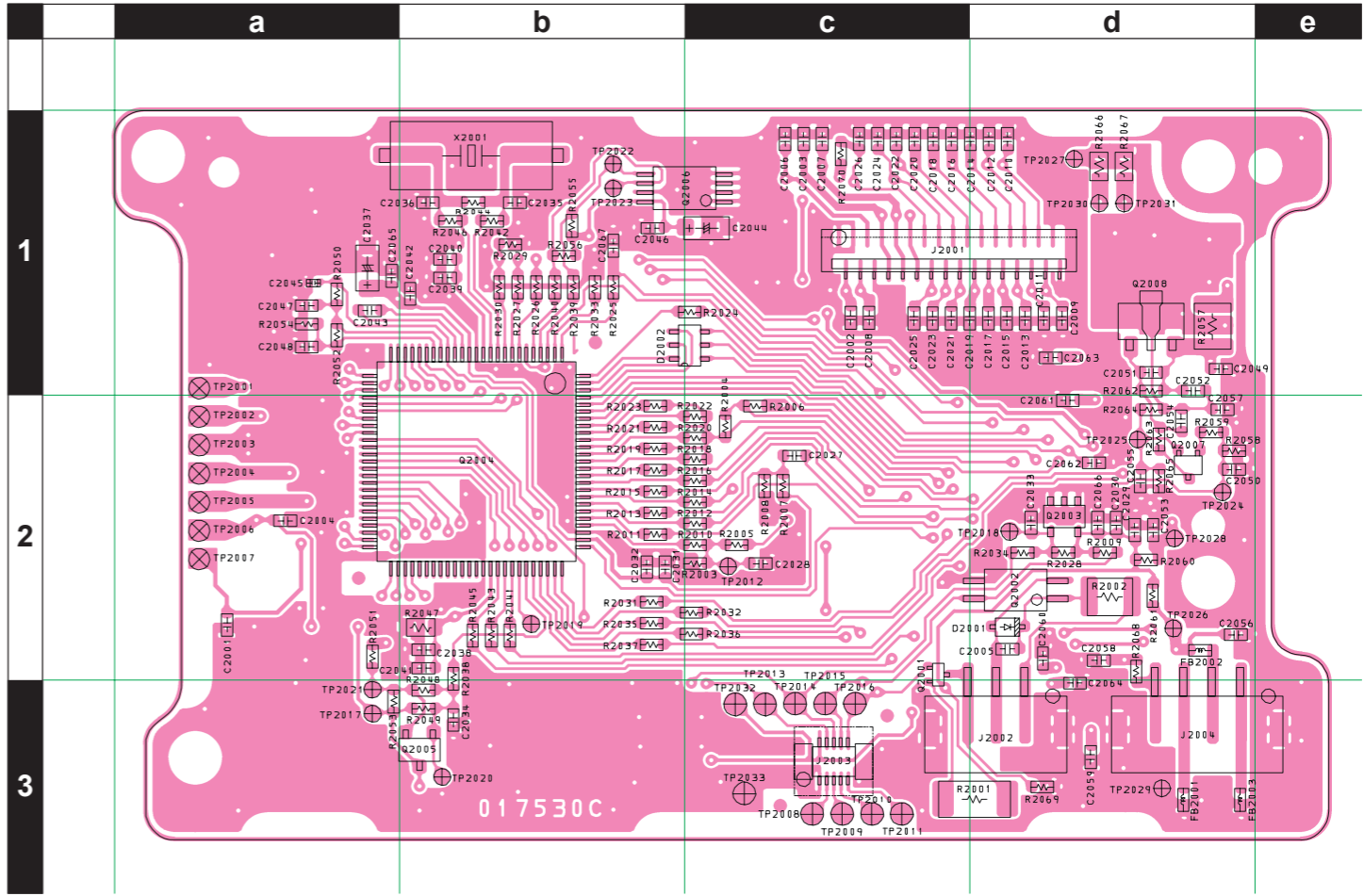

(Side B)

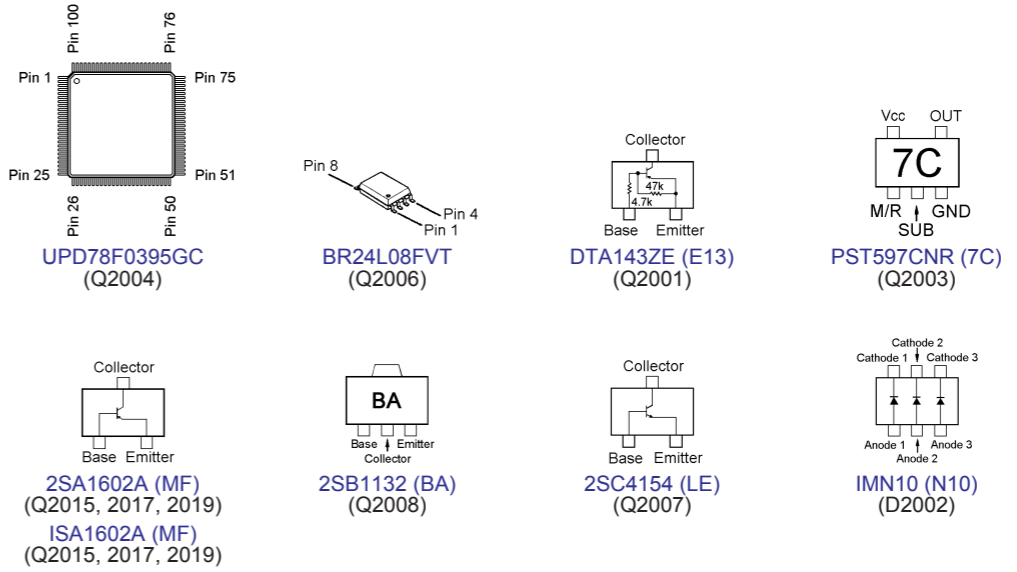

CNTL Unit

Parts List

REF	DESCRIPTION	VALUE	V/W	TOL.	MFR'S DESIG	VXSTD P/N	VERS.	LOT	SIDE	LAY ADR	
P.C.B. with Components						CS1984401	w/VR UNIT				
Printed Circuit Board						AM030N000	FR0175300		1-		
C 2007	CHIP CAP.	0.001uF	25V	CH	GRM1882C1E102JA01D	K22144204		1-	B	c1	
C 2027	CHIP CAP.	0.1uF	25V	F	GRM188F11E104ZA01D	K22145001		1-	B	c2	
C 2028	CHIP CAP.	0.01uF	50V	B	GRM188B11H103KA01D	K22174823		1-	B	c2	
C 2029	CHIP CAP.	0.01uF	50V	B	GRM188B11H103KA01D	K22174823		1-	B	d2	
C 2030	CHIP CAP.	0.001uF	50V	B	GRM188B11H102KA01D	K22174821		1-	B	d2	
C 2031	CHIP CAP.	0.01uF	50V	B	GRM188B11H103KA01D	K22174823		1-	B	b2	
C 2032	CHIP CAP.	1uF	16V	B	C1608JB1C105KT	K22124813		1-	B	b2	
C 2033	CHIP CAP.	100pF	50V	CH	GRM1882C1H101JA01D	K22174235		1-	B	d2	
C 2034	CHIP CAP.	1uF	16V	B	C1608JB1C105KT	K22124813		1-	B	b3	
C 2035	CHIP CAP.	22pF	50V	CH	GRM1882C1H220JA01D	K22174219		1-	B	b1	
C 2036	CHIP CAP.	27pF	50V	CH	GRM1882C1H270JA01D	K22174221		1-	B	b1	
C 2037	CHIP TA.CAP.	10uF	10V		F931A106MAA	K78100078		1-	B	a1	
C 2038	CHIP CAP.	0.01uF	50V	B	GRM188B11H103KA01D	K22174823		1-	B	b2	
C 2039	CHIP CAP.	1uF	16V	B	C1608JB1C105KT	K22124813		1-	B	b1	
C 2040	CHIP CAP.	0.01uF	50V	B	GRM188B11H103KA01D	K22174823		1-	B	b1	
C 2041	CHIP CAP.	1uF	16V	B	C1608JB1C105KT	K22124813		1-	B	b2	
C 2042	CHIP CAP.	0.01uF	50V	B	GRM188B11H103KA01D	K22174823		1-	B	b1	
C 2044	CHIP TA.CAP.	10uF	10V		F931A106MAA	K78100078		1-	B	c1	
C 2045	CHIP CAP.	0.47uF	6.3V	B	GRM155B30J474KE18D	K22088802		1-	B	a1	
C 2046	CHIP CAP.	0.01uF	50V	B	GRM188B11H103KA01D	K22174823		1-	B	b1	
C 2049	CHIP CAP.	0.1uF	25V	F	GRM188F11E104ZA01D	K22145001		1-	B	d1	
C 2050	CHIP CAP.	0.1uF	25V	F	GRM188F11E104ZA01D	K22145001		1-	B	d2	
C 2053	CHIP CAP.	0.01uF	50V	B	GRM188B11H103KA01D	K22174823		1-	B	d2	
C 2054	CHIP CAP.	0.01uF	50V	B	GRM188B11H103KA01D	K22174823		1-	B	d2	
C 2055	CHIP CAP.	0.01uF	50V	B	GRM188B11H103KA01D	K22174823		1-	B	d2	
C 2056	CHIP CAP.	0.01uF	50V	B	GRM188B11H103KA01D	K22174823		1-	B	d2	
C 2057	CHIP CAP.	0.01uF	50V	B	GRM188B11H103KA01D	K22174823		1-	B	d2	
C 2065	CHIP CAP.	0.1uF	16V	B	GRM188B11C104KA01D	K22124805		1-	B	a1	
C 2066	CHIP CAP.	0.1uF	16V	B	GRM188B11C104KA01D	K22124805		1-	B	d2	
C 2067	CHIP CAP.	0.001uF	50V	B	GRM188B11H102KA01D	K22174821		1-	B	b1	
D 2001	DIODE				1SS355(TAPE)	G2071200		1-	B	d2	
D 2002	DIODE				IMN10 T108	G2070078		1-	B	c1	
D 2003	LED				SML-512WWT86	G2071104		1-	A	D2	
D 2004	LED				SML-512WWT86	G2071104		1-	A	D2	
D 2005	LED				SML-512WWT86	G2071104		1-	A	D1	
D 2006	LED				SML-512WWT86	G2071104		1-	A	A1	
D 2007	LED				SML-512WWT86	G2071104		1-	A	A3	
D 2008	LED				SML-512WWT86	G2071104		1-	A	B2	
DS2001	LCD				DTE105978BKZ	G6090184		1-	A	C1	
FB2001	FERRITE BEADS				BK1608HS601-T	L9190083		1-	B	d3	
FB2002	FERRITE BEADS				BK1608HS601-T	L9190083		1-	B	d2	
FB2003	FERRITE BEADS				BK1608HS601-T	L9190083		1-	B	d3	
J 2001	CONNECTOR				32FLT-SM2-TB(LF)(SN)	P1091258		1-	B	c1	
J 2002	CONNECTOR				A2001WV-S-03PD01	P0091502		1-	B	d3	
J 2003	CONNECTOR				AXK6F10345YP	P0091378		1-	B	c3	
J 2004	CONNECTOR				A2001WV-S-04PD01	P0091504		1-	B	d3	
Q 2001	TRANSISTOR				DTA143ZE TL	G3070390		1-	B	c2	
Q 2002	PHOTO COUPLER				PC3H7CDJ000F	G0090039		1-	B	d2	
Q 2003	IC				PST597CNR	G1092589		1-	B	d2	
Q 2004	IC				UPD78F0395GC-8EA-A	G1094521		1-	B	b2	
Q 2006	IC				BR24L08FVT-W(TAPE)	G1094519		1-	B	c1	
Q 2007	TRANSISTOR				2SC4154-T11-1E	G3341548E		1-	B	d2	
Q 2008	TRANSISTOR				2SB1132 T100 R	G3211327R		1-	B	d1	
R 2001	CHIP RES.	150	1/2W	5%	RK73K2HTE150-J	J24279019		1-	B	d3	
R 2002	CHIP RES.	330	1/4W	5%	RMC1/4 331JATP	J24245331		1-	B	d2	
R 2003	CHIP RES.	22k	1/16W	5%	RMC1/16 223JATP	J24185223		1-	B	c2	
R 2004	CHIP RES.	47k	1/16W	5%	RMC1/16 473JATP	J24185473		1-	B	c2	
R 2005	CHIP RES.	100k	1/16W	5%	RMC1/16 104JATP	J24185104		1-	B	c2	
R 2006	CHIP RES.	47k	1/16W	5%	RMC1/16 473JATP	J24185473		1-	B	c2	
R 2007	CHIP RES.	100k	1/16W	5%	RMC1/16 104JATP	J24185104		1-	B	c2	
R 2008	CHIP RES.	100k	1/16W	5%	RMC1/16 104JATP	J24185104		1-	B	c2	
R 2009	CHIP RES.	3.9k	1/16W	5%	RMC1/16 392JATP	J24185392		1-	B	d2	
R 2010	CHIP RES.	0	1/16W	5%	RMC1/16 000JATP	J24185000		1-	B	c2	
R 2011	CHIP RES.	0	1/16W	5%	RMC1/16 000JATP	J24185000		1-	B	b2	
R 2012	CHIP RES.	0	1/16W	5%	RMC1/16 000JATP	J24185000		1-	B	c2	
R 2013	CHIP RES.	0	1/16W	5%	RMC1/16 000JATP	J24185000		1-	B	b2	
R 2014	CHIP RES.	0	1/16W	5%	RMC1/16 000JATP	J24185000		1-	B	c2	
R 2015	CHIP RES.	0	1/16W	5%	RMC1/16 000JATP	J24185000		1-	B	b2	
R 2016	CHIP RES.	0	1/16W	5%	RMC1/16 000JATP	J24185000		1-	B	c2	
R 2017	CHIP RES.	0	1/16W	5%	RMC1/16 000JATP	J24185000		1-	B	b2	
R 2018	CHIP RES.	10k	1/16W	5%	RMC1/16 103JATP	J24185103		1-	B	c2	

CNTL Unit

Parts List

REF	DESCRIPTION	VALUE	V/W	TOL.	MFR'S DESIG	VXSTD P/N	VERS.	LOT	SIDE	LAY ADR
R 2019	CHIP RES.	22k	1/16W	5%	RMC1/16 223JATP	J24185223		1-	B	b2
R 2020	CHIP RES.	47k	1/16W	5%	RMC1/16 473JATP	J24185473		1-	B	c2
R 2021	CHIP RES.	100k	1/16W	5%	RMC1/16 104JATP	J24185104		1-	B	b2
R 2022	CHIP RES.	220k	1/16W	5%	RMC1/16 224JATP	J24185224		1-	B	c2
R 2023	CHIP RES.	4.7k	1/16W	5%	RMC1/16 472JATP	J24185472		1-	B	b2
R 2024	CHIP RES.	0	1/16W	5%	RMC1/16 000JATP	J24185000		1-	B	c1
R 2025	CHIP RES.	0	1/16W	5%	RMC1/16 000JATP	J24185000		1-	B	b1
R 2026	CHIP RES.	0	1/16W	5%	RMC1/16 000JATP	J24185000		1-	B	b1
R 2027	CHIP RES.	0	1/16W	5%	RMC1/16 000JATP	J24185000		1-	B	b1
R 2028	CHIP RES.	10k	1/16W	5%	RMC1/16 103JATP	J24185103		1-	B	d2
R 2029	CHIP RES.	10k	1/16W	5%	RMC1/16 103JATP	J24185103		1-	B	b1
R 2030	CHIP RES.	220	1/16W	5%	RMC1/16 221JATP	J24185221		1-	B	b1
R 2031	CHIP RES.	0	1/16W	5%	RMC1/16 000JATP	J24185000		1-	B	b2
R 2032	CHIP RES.	0	1/16W	5%	RMC1/16 000JATP	J24185000		1-	B	c2
R 2034	CHIP RES.	470	1/16W	5%	RMC1/16 471JATP	J24185471		1-	B	d2
R 2035	CHIP RES.	100	1/16W	5%	RMC1/16 101JATP	J24185101		1-	B	b2
R 2036	CHIP RES.	100	1/16W	5%	RMC1/16 101JATP	J24185101		1-	B	c2
R 2037	CHIP RES.	10k	1/16W	5%	RMC1/16 103JATP	J24185103		1-	B	b2
R 2038	CHIP RES.	10k	1/16W	5%	RMC1/16 103JATP	J24185103		1-	B	b2
R 2039	CHIP RES.	0	1/16W	5%	RMC1/16 000JATP	J24185000		1-	B	b1
R 2040	CHIP RES.	0	1/16W	5%	RMC1/16 000JATP	J24185000		1-	B	b1
R 2041	CHIP RES.	0	1/16W	5%	RMC1/16 000JATP	J24185000		1-	B	b2
R 2042	CHIP RES.	470	1/16W	5%	RMC1/16 471JATP	J24185471		1-	B	b1
R 2043	CHIP RES.	0	1/16W	5%	RMC1/16 000JATP	J24185000		1-	B	b2
R 2045	CHIP RES.	100	1/16W	5%	RMC1/16 101JATP	J24185101		1-	B	b2
R 2046	CHIP RES.	0	1/16W	5%	RMC1/16 000JATP	J24185000		1-	B	b1
R 2048	CHIP RES.	0	1/16W	5%	RMC1/16 000JATP	J24185000		1-	B	b3
R 2051	CHIP RES.	0	1/16W	5%	RMC1/16 000JATP	J24185000		1-	B	a2
R 2055	CHIP RES.	4.7k	1/16W	5%	RMC1/16 472JATP	J24185472		1-	B	b1
R 2056	CHIP RES.	4.7k	1/16W	5%	RMC1/16 472JATP	J24185472		1-	B	b1
R 2057	CHIP RES.	39	1/4W	5%	RMC1/4 390JATP	J24245390		1-	B	d1
R 2058	CHIP RES.	470k	1/16W	5%	RMC1/16 474JATP	J24185474		1-	B	d2
R 2059	CHIP RES.	470	1/16W	5%	RMC1/16 471JATP	J24185471		1-	B	d2
R 2060	CHIP RES.	10k	1/16W	5%	RMC1/16 103JATP	J24185103		1-	B	d2
R 2061	CHIP RES.	1k	1/16W	5%	RMC1/16 102JATP	J24185102		1-	B	d2
R 2062	CHIP RES.	2.2k	1/16W	5%	RMC1/16 222JATP	J24185222		1-	B	d1
R 2063	CHIP RES.	470	1/16W	5%	RMC1/16 471JATP	J24185471		1-	B	d2
R 2064	CHIP RES.	470	1/16W	5%	RMC1/16 471JATP	J24185471		1-	B	d2
R 2065	CHIP RES.	470	1/16W	5%	RMC1/16 471JATP	J24185471		1-	B	d2
R 2066	CHIP RES.	150	1/10W	5%	RMC1/10T 151J	J24205151		1-	B	d1
R 2067	CHIP RES.	150	1/10W	5%	RMC1/10T 151J	J24205151		1-	B	d1
R 2068	CHIP RES.	0	1/16W	5%	RMC1/16 000JATP	J24185000		1-	B	d2
R 2069	CHIP RES.	2.2k	1/16W	5%	RMC1/16 222JATP	J24185222		1-	B	d3
R 2070	CHIP RES.	10k	1/16W	5%	RMC1/16 103JATP	J24185103		1-	B	c1
X 2001	XTAL HC-49/SS-SMD	18.432MHz			18.432MHZ	H0103369		1-	B	b1
	LIGHT GUIDE				(LCD)	RA0975100		1-		
	INTER CONNECTOR				(LCD)	RA0975400		1-		
	REFLECTOR SHEET				(LCD)	RA0975500		1-		
	SPONGE RUBBER				(LCD)	RA0975200		1-		

MIC Unit

Circuit Diagram

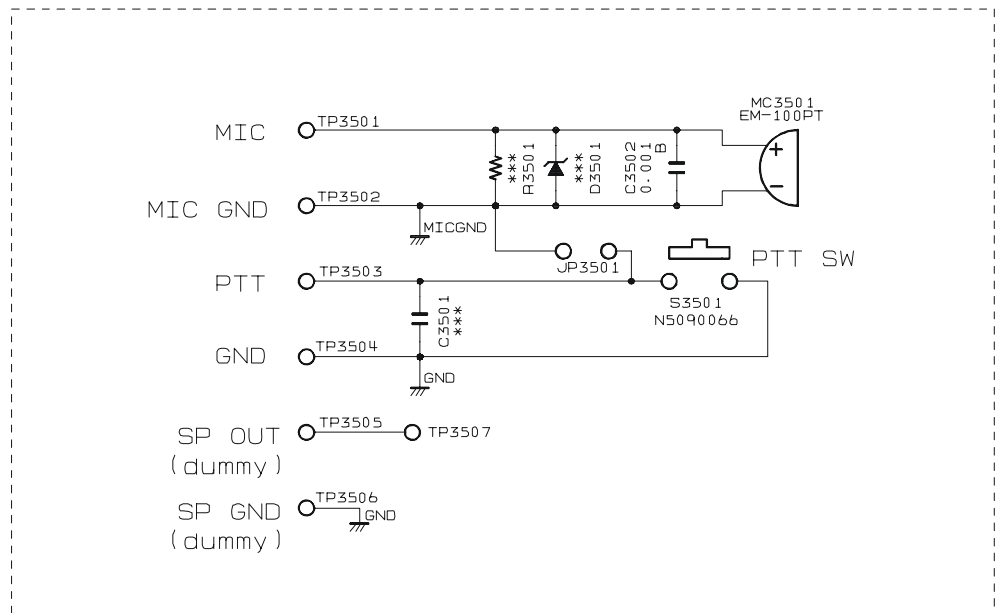

Parts Layout

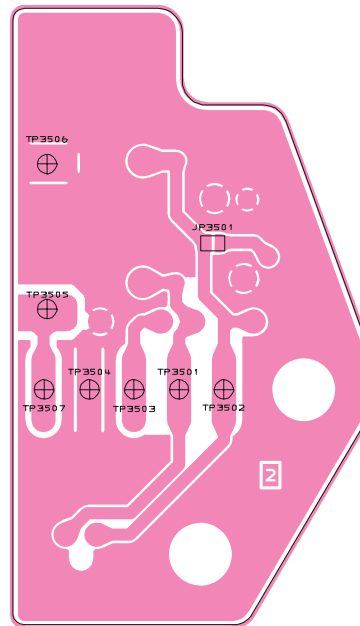

(Side A)

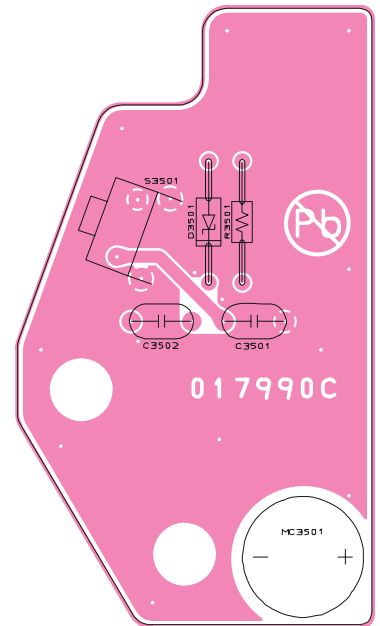

(Side B)

Parts List

REF	DESCRIPTION	VALUE	V/W	TOL.	MFR'S DESIG	VXSTD P/N	VERS.	LOT	SIDE	LAY ADR
	Printed Circuit Board				AM030N000	FR017990C		1-		
C 3502	CERAMIC CAP.	0.001uF	50V	B	BU5 102K6(5MM)	K10179056		1-	B	a2
MC3501	MIC. ELEMENT				EM-100PT	M3290029		1-	B	b3
S 3501	TACT SWITCH				SKHLLD	N5090066		1-	B	a1

VR Unit

Parts Layout

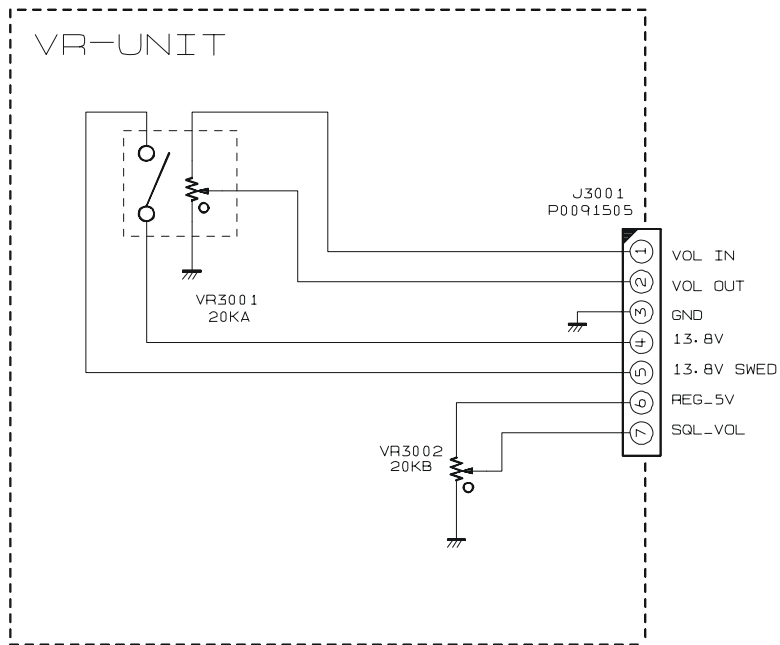

Parts Layout

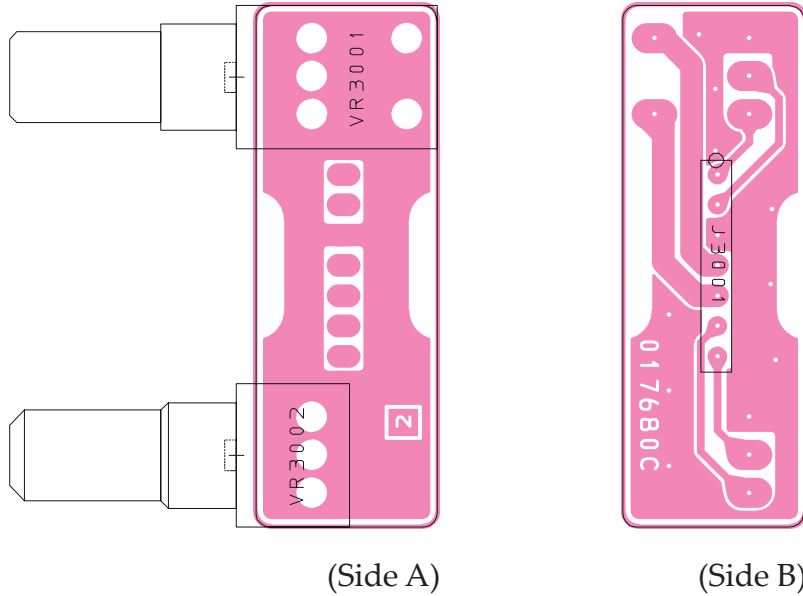

Parts List

REF	DESCRIPTION	VALUE	V/W	TOL.	MFR'S DESIG	VXSTD P/N	VERS.	LOT	SIDE	LAY ADR
	Printed Circuit Board				AM030N000	FR0176800		1-		
J 3001	CONNECTOR				21B12050-07S10B01G3.5/3.5	P0091505		1-	B	a1
VR3001	POT.				WH9011AK-1-34D15/5H=5A20K	J60800294		1-	A	A1
VR3002	POT.				WH9011A-1-40D15/5H=5B20K	J60800295		1-	A	A2



Copyright 2008
VERTEX STANDARD CO., LTD.
All rights reserved

No portion of this manual
may be reproduced without
the permission of
VERTEX STANDARD CO., LTD.