

FURUNO

OPERATOR'S MANUAL

MARINE VHF
RADIOTELEPHONE

Model FM-2710



FURUNO ELECTRIC CO., LTD
NISHINOMIYA, JAPAN

© **FURUNO ELECTRIC CO., LTD.**

9-52, Ashihara-cho,
Nishinomiya, Japan

Telephone: 0798-65-2111
Telefax: 0798-65-4200

•Your Local Agent/Dealer

All rights reserved.

Printed in Japan

FIRST EDITION : NOV. 1997
C : FEB. 21, 2000

(TATA)

PUB. No. OME-56160
FM-2710



* 00080829900 *



SAFETY INFORMATION FOR THE OPERATOR



WARNING



Do not open the cover of the equipment.

This equipment uses high voltage electricity which can shock, burn. Only qualified personnel should work inside the equipment.

Do not disassemble or modify the equipment.

Fire, electrical shock or serious injury can result.

Immediately turn off the power at the ship's mains switchboard if water or foreign object falls into the equipment or the equipment is emitting smoke or fire.

Continued use of the equipment can cause fire, electrical shock or serious injury.



CAUTION

Do not place liquid-filled containers on the top of the equipment.

Fire or electrical shock can result if a liquid spills into the equipment.

Do not place heater near the equipment.

Heat can melt the power cord, which can result in fire or electrical shock.

Do not operate the unit with wet hands.

Electrical shock can result.

Use the correct fuse.

Use of the wrong fuse can cause fire or equipment damage.



SAFETY INFORMATION FOR THE OPERATOR



WARNING



Only qualified personnel should work inside the equipment.

This equipment uses high voltage electricity which can shock, burn, or cause death.

Turn off the power at the ship's mains switchboard before beginning the installation. Post a warning sign near the switchboard to ensure that the power will not be applied while the equipment is being installed.

Serious injury or death can result if the power is not turned off, or is applied while the equipment is being installed.



CAUTION

Confirm that the power supply voltage is compatible with the voltage rating of the equipment.

Connection to the wrong power supply can cause fire or equipment damage. The voltage rating appears on the label at the rear of the equipment.

Table of Contents

1. Introduction	2	3-2. Operating Procedure	21
1-1. Features of the FURUNO FM-2710	3	3-2-1. Receiving	21
1-2. Specifications	4	3-2-2. Transmitting	24
2. Installation	7	4. General Notes on Operating Marine VHF	26
2-1. Unpacking and Inspection	7	4-1. Rules and Manners	26
2-2. Equipment Supplied	7	4-2. Communication Distance	28
2-3. Mounting the Transceiver	9	5. Maintenance	29
2-3-1. Transceiver Mounting Methods	9	5-1. Cleaning of Transceiver	29
2-3-2. Mechanical Installation	10	5-2. Antenna System Check	30
2-3-3. Electric Connections	11	5-3. Battery Check	30
2-3-4. Power Connection	12	5-4. Fuse Replacement	30
2-3-5. Antenna Connection	13	6. Troubleshooting	31
3. Operation	15	7. Appendix	34
3-1. Controls and Indications	15	7-1. VHF Marine Channel Frequencies	34
3-1-1. Controls	16	(International, USA, Weather)	
3-1-2. Indications	19	7-2. Block Diagram	39

1. Introduction

Congratulations on your choice of the FURUNO FM-2710 Marine VHF Radiotelephone.

We are confident that you will enjoy many years of trouble-free operation with this fine piece of equipment.

For nearly 50 years FURUNO Electric Company has enjoyed an enviable reputation for quality and reliability

throughout the world. This dedication is furthered by our extensive global network of agents and dealers.

Your equipment is designed and constructed to provide commercial grade performance and reliability, yet is affordable for pleasure craft owners.

Please carefully read this manual and follow the recommended procedure for installation, operation and maintenance. With proper care, your equipment should provide years of enjoyable and dependable communications.

Thank you for considering and purchasing FURUNO product.

1-1. Features of the FURUNO FM-2710

- 25 W RF output from a compact cabinet: may be mounted in any small space.
- Water-resistant structure (CFR-46 FCC Regulation Spec.)
- All VHF channels according to ITU-R Radio Regulations Appendix S 18 and FCC Part 80, plus 10 weather channels (U.S.A. and Canada)
- With the [9/ALL] key, you can program a channel most frequently used in CH09.
- Easy channel selection by the rotary channel knob.
- Dual watch function between CH16 and a selected channel. When a weather alert signal is received, the mode changes from dual watch to weather alert.
- Adjustable backlight for the large high-contrast LCD and control keys.
- Advanced commercial grade design and components.

1-2. Specifications

GENERAL

1. Radio Compliance	USA Part 80, DOC Cat. V
2. Number of Channels	All VHF channels according to ITU-R Radio Regulations Appendix S 18 and FCC Part 80, plus 10 weather channels (U.S.A. and Canada)
3. Supply Voltage	12 VDC nominal -10%, +30% (10.8 - 15.6 VDC)
4. Modulation Type	Frequency modulated 16K0G3E
5. Operating Temperature	-20°C to +50°C
6. Water Resistance	CFR 46 parts 110, 111
7. Size	161 mm (W) X 60 mm (H) X 163 mm (D)
8. Mass	Approximately 1.1 kg
9. Antenna	M-type connector
10. Power / Ext. Spkr	Power cable 2 m (with Fuse), 4-wire cable assembly

RECEIVER

- | | |
|---|--|
| 1. Frequency Range | 156.025 to 163.275 MHz |
| 2. AF Output | 3 W at 4 ohms load (less than 10% at 1 kHz) |
| 3. Current Drain | Less than 250 mA |
| 4. AF Response | 6 dB/oct de-emphasis +1/-3 dB from 300 to 3000 Hz |
| 5. Intermodulation | Better than 68 dB |
| 6. Sensitivity | 0.3 μ V (-117.5 dBm) for 12 SINAD
-4.5 dB μ (20 dB SINAD) |
| 7. Squelch Sens. Threshold | 0.2 μ V (-121 dBm) or better |
| 8. Tight Squelch Sensitivity | 0.8 μ V (-109 dBm) |
| 9. Adjacent Channel Selectivity | Better than 70 dB |
| 10. Spurious Reponse | Better than 68 dB |
| 11. Conducted Spurious Emission conveyed to the Antenna | Less than 2 nW (-57 dBm) |
| 12. Hum and Noise | Less than -40 dB |

TRANSMITTER

1. Frequency Range	156.025 to 157.425 MHz
2. Channel Spacing	25 kHz
3. RF Output Power	25 W (HI), 1 W (LOW) switchable
4. Input Current	Less than 6.0 A Max at 25 Watts Less than 1.5 A Max at 1 Watt
5. Frequency Stability	±1.5 kHz
6. Frequency Deviation	±5 kHz Max
7. Modulation AF Response	6dB/oct Preemphasis +1/-3 dB from 300 to 3000 Hz
8. Time-Out Timer	5 minutes ±10%
9. Hum & Noise Level	Less than -40 dB below audio (less than 10% at 1kHz for ±3 kHz)
10. Spurious & Harmonic Emission	Attenuated at least 43+10 Log Power (mean power)

2. Installation

2-1. Unpacking and Inspection

Carefully unpack the unit from the shipping carton to avoid damaging the contents.

It is also recommended to keep the carton and the packing materials. In an unlikely case that the unit has to be returned to the factory, the original packing materials should be used.

2-2. Equipment Supplied

Description
VHF Radiotelephone
DC power cable
Mounting bracket with screw knobs
Truss tapping screw set
Mic hanger set
Operator s manual
Spare fuse

.....

Transceiver Location

Select the mounting location for the transceiver considering the following:

- Though the equipment is spray-proof, prolonged exposure to the environment can shorten its life. It is recommended to install the equipment in the cabin or at least in a shaded place.
- The equipment should be located as near to the power source as possible, and as far apart as possible from any devices that may cause interference such as direction finders, navigation receivers and other onboard electronics.
- The cabinet of the equipment, especially the rear panel, gets warm after a long transmission. Therefore, provide some space around the transceiver to allow for circulation of cooling air.

Compass safe distance

Standard: 1.7m

Steering : 0.8m

2-3. Mounting The Transceiver

2-3-1. Transceiver Mounting Methods

The equipment can be mounted on the overhead, a tabletop or a bulkhead. The mounting location should be able to support the weight of the unit.

If necessary, reinforce the mounting location by lining block or doubling plate.

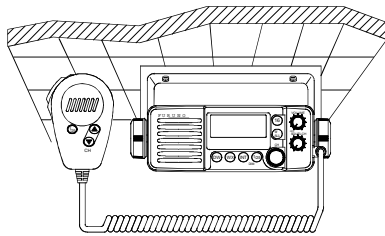

**OVERHEAD
(DASHBOARD)**

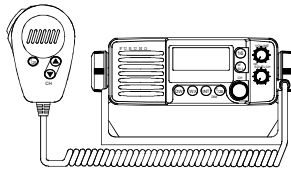

TABLETOP

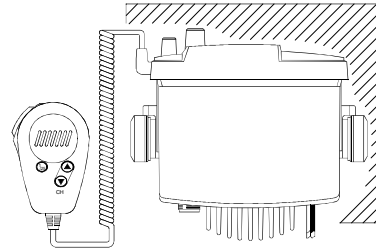

BULKHEAD

Fig. 2-1 Mounting Methods

2-3-2. Mechanical Installation

Before actually mounting your FM-2710, find where the vessel's power supply and ground are located, and where the antenna can be mounted. The antenna should be at least 3 feet away from the radio and as high as possible.

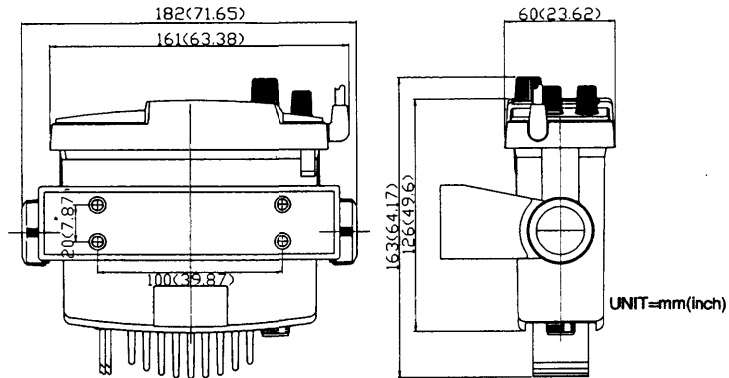

Fig. 2-2: Mounting dimensions of Transceiver

Mounting Procedure

1. Mount the hanger with four screws
2. Fit the transceiver to the hanger with two knobs

2-3-3. Electrical Connections

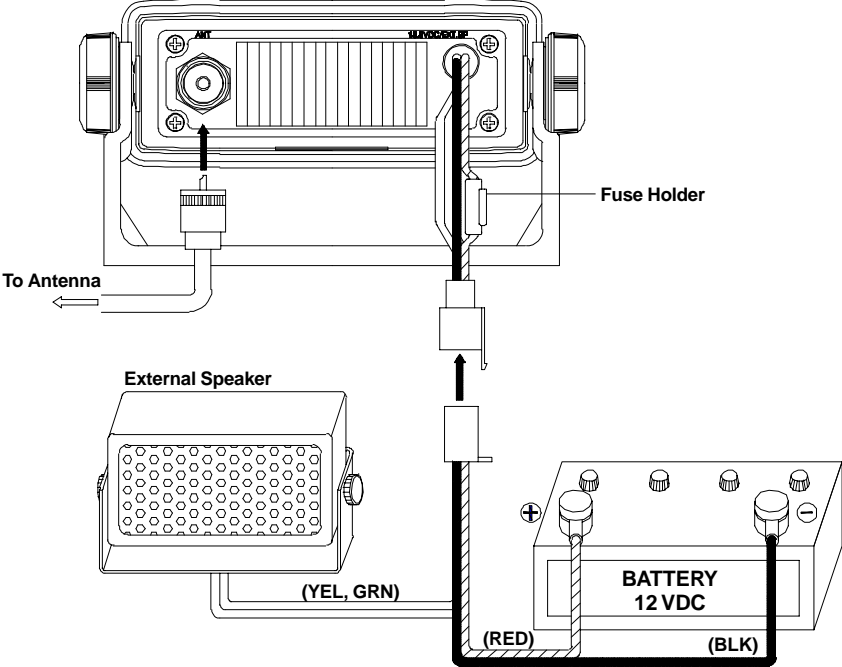

Fig. 2-3 Electrical Connections

2-3-4. Power Connection

The power external speaker cable is provided with external loudspeaker attachments. The speaker cable is 6 feet long and plugs into the 4P connector cable at the rear panel of the radio. The RED(+) wire with an in-line fuse (10 A) and the BLACK(-) wire of the 4P connector cable connect the FM-2710 to the ship's 12 VDC power supply.

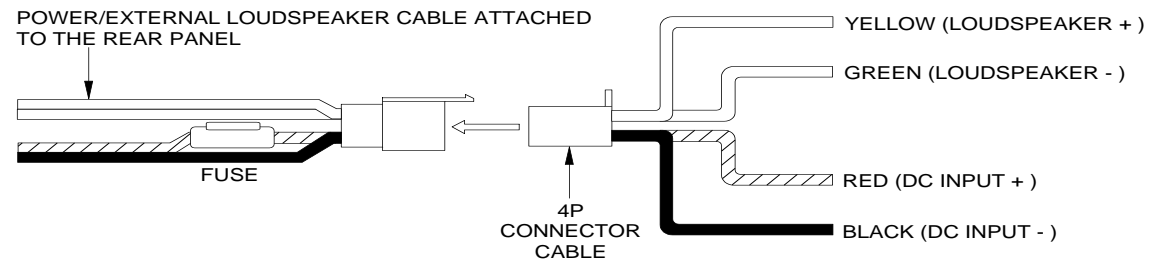

Fig. 2-4 Power Connection

- External Speaker

The FM-2710 has a built-in speaker. However, if an external loudspeaker (4 W/4 ohms) is desired, connect it to external speaker cable.

2-3-5. Antenna Connection

Provide a location as high and clear as possible, free from the influence of nearby antenna, rigging and masts.

However, any good quality antenna, complying with the following requirements, may be arranged locally. A high-gain antenna is preferable. If you are not sure, consult with your dealer.

- Frequency range: 155 MHz to 164 MHz
- Impedance: 50 ohms
- Polarization: Vertical
- Input power: 30 W
- Quality: Able to withstand marine environment

Any 50 ohm coaxial cable heavier than 5D-2V (equivalent to RG-212/U) may be used for the connection between the antenna and the transceiver. To extend the antenna cable longer than 20 m, use heavier coaxial cable, such as 8D-2V or RG-213/U, to minimize power loss and signal attenuation through the cable. Make sure to leave some slack in the cable loop behind the transceiver for service and maintenance ease.

Lay the antenna, and then solder the M-type connector onto the cable end as shown below.

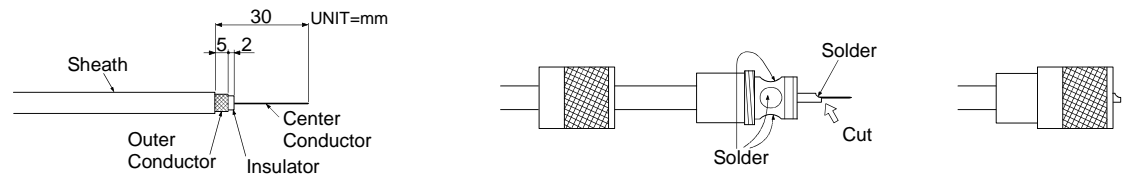

Fig. 2-5 Soldering the M-type connector

3. Operation

3-1. Controls and Indications

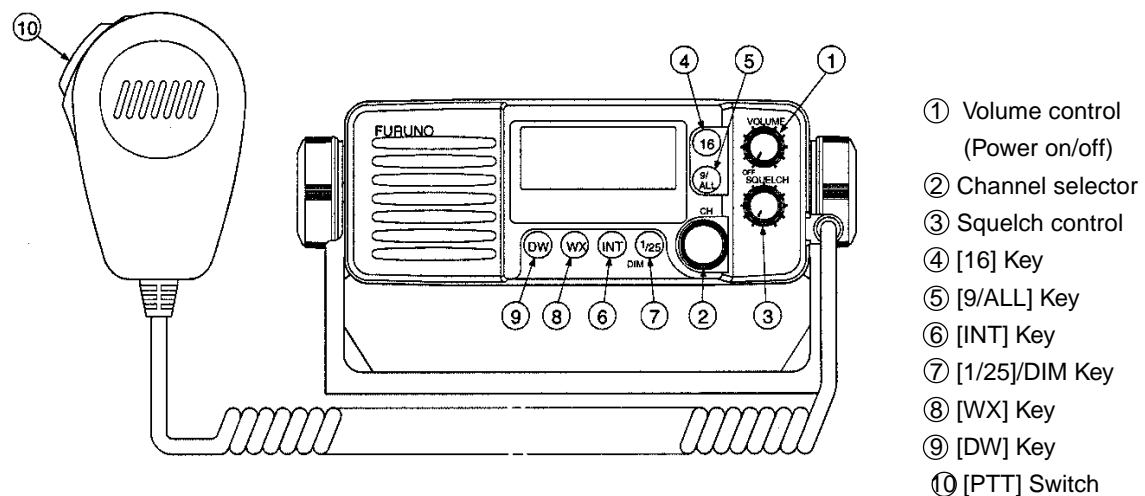

Fig. 3-1 Controls

3-1-1. Controls



1) Volume Control(Power on/off)

Turns the radio on /off and adjusts volume of the speaker.

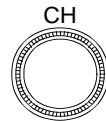

2) Channel Selector

Selects channels.

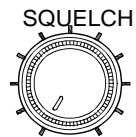

3) Squelch Control

Adjusts the squelch. Rotate the control counterclockwise until noise is heard, then rotate it clockwise slowly until noise just fades out.



4) [16] Key

Immediately selects CH16. Next pressing returns control to previously selected channel.

9/
ALL

5) [9/All] Key

Selects CH09 or the preset channel instantly. If no preset channel exists, CH09 is selected. To reserve a channel to use, select it with the Channel selector and press and hold down the [9/All] key for more than 3 seconds.

INT

6) [INT] Key (International and USA channels)

Each time pressing, alternately changes international and USA channels. "INT" or "USA" appears with each pressing.

1/25

DIM

7) [1/25]/DIM Key

This key has two functions. When simply pressed, it alternately changes the transmitter output power from 1 watt ("LOW" appears) to 25 watts ("LOW" disappears). When pressed and held for more than 1 second, the brightness of the backlight is changed to High, Low or Off.

WX

8) [WX] Key (Weather channel receiving mode)

Selects the Weather channel receiving mode. "WX" appears along with the weather channel number (0-9). While the radio is in this mode, the transmitter is always disabled. To return to the normal receiving mode, press any of the following keys: [WX], [16] or [9/All].



9) [DW] Key (Dual Watch mode)

Selects the Dual Watch mode. "DW", "16" and the selected working channel appear. The radio automatically monitors CH16 (priority), the selected working channel, and the Weather channel. To return to the receiving mode, press any key except [INT] and [1/25]/DIM, or turn the Channel selector.



10) [PTT] Switch (Push-To-Talk)

Press to transmit; release to listen. "TX" appears.

3-1-2. Indications

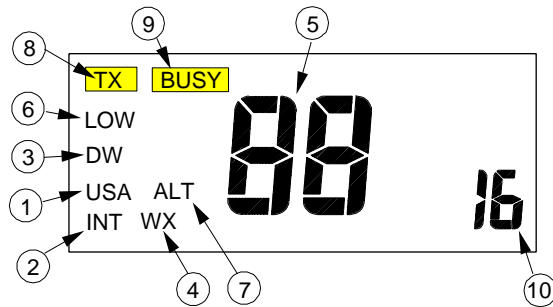

Fig. 3-2 Indications

- 1) **"USA"** : Appears when the USA mode is selected with the [INT] key.
- 2) **"INT"** : Appears when International mode is selected with the [INT] key.
- 3) **"DW"** : Appears when Dual Watch mode is activated with the [DW] key.
- 4) **"WX"** : Appears when the Weather channel mode is activated with the [WX] key.

- 5) : "**LCD Segments**" : Shows the channel number in use. Select a channel with the Channel selector.
- 6) "**LOW**" : Appears when the transmitter output power has been set to Low power (1 watt) with the [1/25]/Dim, or when a low power channel has been selected with the Channel selector.
- 7) "**ALT**" (**Weather Alert**) : Blinks when a weather alert tone has been received.
- 8) "**TX**" (**Transmit**) : Appears when the [PTT] switch on the microphone is pressed and held. Transmitter output power is provided to the antenna.
- 9) "**BUSY**" : Appears when a signal is being received and the squelch is open.
- 10) "**16**" : Appears when the radio is in the DW mode, indicating that CH16 is being monitored.

3-2. Operating Procedure

3-2-1. Receiving

1. Power On

Turn the Volume control clockwise to turn the radio on. The equipment starts up with CH16 or DW mode.

To switch off the power, turn the control fully counterclockwise.

2. Adjusting Dimmer

Press and hold the [1/25]/DIM key for more than 1 sec. The brightness of the backlight changes from High to Low or Off with each pressing.

3. Selecting USA/INT

USA or INT appears for channel assignment. To change the mode, press the [INT] key.

4. Selecting Channel

Rotate the Channel selector to choose channel number.

5. Adjusting Squelch

Rotate the Squelch control counterclockwise until you hear noise from the speaker. Then, rotate the knob slowly clockwise until the receiver noise just fades out.

6. Adjusting Volume

Turn the Volume control to adjust the volume of speaker.

Audible Alarm Audible alarms are generated in the following conditions:

- 1) One short beep: Valid key operation
- 2) 3 short beeps: Invalid key operation
- 3) One 5 sec. beep: Weather alert

Dual Watch Mode

The Dual Watch mode allows you to monitor CH16 and the selected working channel and the Weather channel. Once the squelch is properly set, select a working channel to show on the LCD, and press the [DW] key. "DW", "16" and the selected working channel appear on the LCD, and scanning begins.

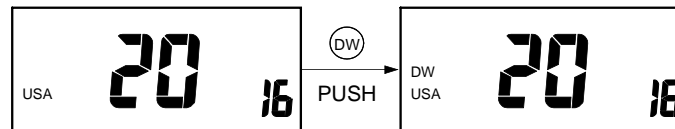

If a signal is present on CH16, the receiver locks on CH16 and ignores the other channels. After the signal has gone, the receiver stays on CH16 for 5 seconds, and then reverts to the Dual Watch mode again.



In the case that a signal is present on the selected working channel, CH16 is monitored momentarily (for 150 msec) once in 5 seconds. After the signal has gone, the receiver stays on that channel for 5 seconds, and then reverts to the Dual Watch mode.

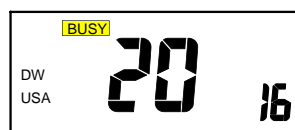

← "16" is displayed momentarily once in 5 seconds

To quit the DW mode, simply press any key except [INT] and [1/25]/DIM, or rotate the Channel selector.

3-2-2. Transmitting

1. Select the desired mode (International or USA) by pressing the [INT] key. Each time the key is pressed, the mode changes to INT or USA, and "INT" or "USA" appears on the LCD.
2. Select the desired channel by rotating the Channel selector.
3. To set the transmitter to high or low power, press [1/25]/DIM key and release within 1 second.
This alternately changes the transmitter output power from 1 watt ("LOW" appears) to 25 watts ("LOW" disappears).

Transmit at low power for short range communications or when in harbor areas, to minimize interference to others.

Note: The following channels are automatically set to low power (1 watt):

USA: 13*, 17, 67*, 77

* Channels 13 and 67 can be switched to high power (25 W) if [1/25]/DIM key is pressed while [PTT] switch is on.

Transceiver is designed not to transmit on US channel 15.

4. Pick up the microphone, press the [PTT] switch, and then call the party you want to talk with. Hold the microphone fairly close to your mouth and speak clearly.

Press and hold the [PTT] switch to talk, and release it to listen for the response.

If the [PTT] switch is held for more than 5 minutes, transmit function is disabled, a beep sound, and "to" (time out) blinks instead of the channel display. This condition continues until the [PTT] switch is released.

IMPORTANT:

CH16 is used in all USA coastal areas to call the Coast Guard and for general vessel calling. In certain high traffic areas, CH09 is also used as the Hailing Frequency. Please check with your local Coast Guard.

4. General Notes on Operating Marine VHF

4-1. Rules and Manners

The FM-2710 fully complies with the requirements for international maritime VHF radio service. It is intended to be used by a person who holds a valid radio operator's license and station call sign.

Below are some important rules, regulations and manners for operating the equipment.

- Whenever the radio is turned on, keep watch on CH16 for distress or calling message.
- Distress communications have absolute priority. If you hear MAYDAY, talk only if you can help, and be prepared to offer assistance or relay the distress message.
- Listen before transmitting to avoid interfering with other communications.
- The ship Radiotelephone Station Licensee is responsible for recording in a communication log all contacts made over the telephone and watch period on CH16. All distress, emergency and safety messages must be recorded in detail. Entries must show boat's name, call sign, watch start/stop times, and operator's signature. Use 24-hour notation to record time.
- Radio waves are public property. Keep all communications as brief and clear as possible.

- Declare ID or call sign at the beginning and end of each communication.
- Use appropriate channels.
- Do not divulge contents of communications nor use them for private benefit without permission.
(This does not apply to distress communication.)
- Be aware that many people are listening. Do not use indecent or profane language.

4-2. Communication Distance

The FM-2710 operates on the VHF band assigned for maritime mobile stations (156.025 to 163.275 MHz).

The VHF radio wave, unlike LF or HF, propagates like a light ray. Thus communication is only available with another VHF antenna which is above the horizon. This is called line-of-sight.

Even if a clear line-of-sight condition exists, the radio wave is attenuated along the signal path. The communication distance is limited also by transmitter power, antenna efficiency and receiver sensitivity.

The average communication range, using 25 W marine VHF, is **10 to 15 nm for ship-to-ship** and **20 to 30 nm for ship-to-shore**.

Note that an obstruction in the signal path, such as a large ship, crane, building or mountain, can destroy VHF communications even for a short distance.

5. Maintenance

The FM-2710 is designed to provide years of trouble-free operation. It is, however, recommended to inspect and maintain the following points to minimize the possibility of equipment failure and assure optimum performance. Be sure to disconnect the power cable at the fuse holders before performing any maintenance work.

5-1. Cleaning of Transceiver

Cabinet, LCD

Keep the unit clean and dry at all times. Dust or loose dirt accumulated on the front panel and knobs should be wiped off with a soft, dry cloth. For stubborn dirt, use mild detergent and water on a cotton tipped swab or soft cloth. Never use plastic solvents, such as thinner or acetone for cleaning; they may dissolve paint coating/markings on the front panel and cabinet case.

Connectors

Check all connectors for foreign material and corrosion. If corroded, clean the contact and re-tighten securely.

5-2. Antenna System Check

Since the antenna is exposed to direct sunlight and salt water spray, it is subject to corrosion or salt water immersion at the antenna base. Physical damage, such as a crack, may occur under heavy ship's vibration. If cracks or water immersion is found, contact FURUNO dealer for servicing.

5-3. Battery Check

The FM-2710 operates normally at any voltage between 11 and 15 VdC. If the battery voltage is out of ratings, check the battery liquid and the charging system of your boat. Check also rust or corrosion at the battery terminals and the ship's mains switch-board for poor contact.

5-4. Fuse Replacement

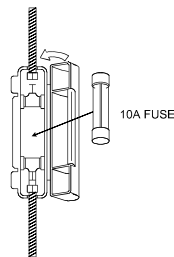

 CAUTION
Use the correct fuse. Use of the wrong fuse can cause fire or equipment damage.

To protect the transceiver from serious damage, a 10A fuse is provided in the snap-in fuse holder on the power cable. The fuse protects against over-voltage/reverse polarity of the ship's mains or internal fault of the equipment. If the fuse has blown, first find the cause of the problem before replacing it.

6. Troubleshooting

Minor Troubleshooting

Most of VHF troubles are caused not by the transceiver itself but by the ANT/feeder or power supply system. The list below provides simple troubleshooting that can be done by the operator. DO NOT ATTEMPT TO CHECK INSIDE THE TRANSCEIVER. CARELESS HANDLING MAY CAUSE PERMANENT DAMAGE TO THE TRANSCEIVER.

Symptom	Possible Cause	Remedy
Volume control turned clockwise but power does not come on.	Power is off at mains switchboard.	Turn mains switch on.
	Power lead is loose or disconnect.	Secure connector firmly and check connections to battery.
	Mains battery is flat.	Check battery liquid, charging system, etc.
	Fuse has blown.	Check mains voltage and polarity and then replace fuse (10A).
LCD looks normal but no sound.	SQUELCH setting is too high. (Turned too far clockwise.)	To confirm audio output, turn SQUELCH fully CCW and turn VOLUME slowly CW.
	VOLUME setting is too low.	

Symptom	Possible Cause	Remedy
Noise but no or poor signal reception	ANT connector (rear panel) is loose or disconnected.	Fasten antenna connector tightly.
	Antenna has separated.	Install new antenna vertically.
	Antenna cable is damaged or immersed with water.	Lay new cable (50 ohm coaxial cable).
	Radio Barrier (large vessel, crane, mountain, etc.) in the signal path.	Line-of-sight is a rule for VHF communications.
	Transmitter is too far away or transmitting in low power.	
“TX” mark appears but no or low output power.	Refer to items above.	
	POWER setting is “LOW”.	Set it to “HI”.
	The channel is to be operated in low power. (“LOW” appears.)	INTL and US channels 13, 17, 67, 77 are low power channels.

Symptom	Possible Cause	Remedy
“TX” mark does not come on when PTT switch is pressed.	Attempting transmission on a channel assigned only for reception: USA 2, 15, 70, 75, 76 INT 70, 75, 76 WX0 through WX9, etc.	Refer to channel list.
Does not scan normally on “DW” mode. (locked on a channel)	SQUELCH setting too low, causing noise.	Adjust SQUELCH so that noise just fades out.
Turned suddenly to CH16.	Had momentary power failure.	Select desired channel and function again. Check power line connections.

7. Appendix

7-1. VHF Marine Channel Frequencies

International Version:

CH	Ship Tx	Ship Rx	Type of Operation
01	156.050	160.650	—
02	156.100	160.700	—
03	156.150	160.750	—
04	156.200	160.800	—
05	156.250	160.850	Port Operations
06	156.300	156.300	Intership Safety
07	156.350	160.950	Com'l
08	156.400	156.400	Com'l
09	156.450	156.450	Call & Ship/Ship
10	156.500	156.500	Com'l & Ship/Ship
11	156.550	156.550	Com'l & Ship/Ship
12	156.600	156.600	Port Operations
13	156.650	156.650	Nav. Ship/Bridge
14	156.700	156.700	Port Operations

CH	Ship Tx	Ship Rx	Type of Operation
15	156.700	156.750	Environmental
16	156.800	156.800	Emerg./Calling
17	156.850	156.850	State Controlled
18	156.900	161.500	Com'l
19	156.950	161.550	Com'l
20	157.000	161.600	Port Operations
21	157.050	161.650	Coast Guard
22	157.100	161.700	Coast Guard
23	157.150	161.750	Coast Guard
24	157.200	161.800	Public Corresp.
25	157.250	161.850	Public Corresp.
26	157.300	161.900	Public Corresp.
27	157.350	161.950	Public Corresp.
28	157.400	162.000	Public Corresp.

CH	Ship Tx	Ship Rx	Type of Operation
60+	156.025	160.625	—
61+	156.075	160.675	—
62+	156.125	160.725	—
63	156.175	160.775	Com'l
64+	156.225	160.825	—
65	156.275	160.875	Port Operations
66	156.325	160.925	Port Operations
67	156.375	156.375	Com'l
68	156.425	156.425	Non Com'l
69	156.475	156.475	Non Com'l
71	156.575	156.575	Non Com'l
72	156.625	156.625	Non Com'l
73	156.675	156.675	Port Operations

CH	Ship Tx	Ship Rx	Type of Operation
74	156.725	156.725	Port Operations
77	156.875	156.875	Port Operations
78	156.925	161.525	Non Com'l
79	156.975	161.575	Com'l
80	157.025	161.625	Com'l
81	157.075	161.675	Coast Guard
82	157.125	161.725	Coast Guard
83	157.175	161.775	Coast Guard
84	157.225	161.825	Public Corresp.
85	157.275	161.875	Public Corresp.
86	157.325	161.925	Public Corresp.
87	157.375	161.975	Public Corresp.
88	157.425	162.025	Com'l

+ Assigned by Canadian Government, proper authorization must be ensured prior to use.

USA Version:

CH	Ship Tx	Ship Rx	Type of Operation
01A	156.050	156.050	Port Operations & Com'l
03A***	156.150	156.150	—
05A	156.250	156.250	Port Operations
06	156.300	156.300	Intership Safety
07A	156.350	156.350	Com'l
08	156.400	156.400	Com'l
09	156.450	156.450	Boater Calling
10	156.500	156.500	Com'l
11	156.550	156.550	Com'l
12	156.600	156.600	Port Operations
13**	156.650	156.650	Intership Nav, Safety
14	156.700	156.700	Port Operations
15#	—	156.750	Environmental
16	156.800	156.800	Distress, Safety/Calling

CH	Ship Tx	Ship Rx	Type of Operation
17*	156.850	156.850	Maritime control
18A	156.900	156.900	Com'l
19A	156.950	156.950	Com'l
20A	157.000	157.000	Intership only
21A***	157.050	157.050	—
22A	157.100	157.100	Coast Guard
23A***	157.150	157.150	—
24	157.200	161.800	Public Corresp.
25	157.250	161.850	Public Corresp.
26	157.300	161.900	Public Corresp.
27	157.350	161.950	Public Corresp.
28	157.400	162.000	Public Corresp.
61A***	156.075	156.075	—
63A	156.175	156.175	Port Operations & Com'l

CH	Ship Tx	Ship Rx	Type of Operation
64A***	56.225	156.225	—
65A	156.275	156.275	Port Operations
66A	156.325	156.325	Port Operations
67**	156.375	156.375	Com'l-Intership only
68	156.425	156.425	Non Com'l
69	156.475	156.475	Non Com'l
71	156.575	156.575	Non Com'l
72	156.625	156.625	Non Com'l
73	156.675	156.675	Port Operations
74	156.725	156.725	Port Operations
77*	156.875	156.875	Port Operations- Intership only

CH	Ship Tx	Ship Rx	Type of Operation
78A	156.925	156.925	Non Com'l
79A	156.975	156.975	Com'l
80A	157.025	157.025	Com'l
81A***	157.075	157.075	—
82A***	157.125	157.125	—
83A***	157.175	157.175	—
84	157.225	161.825	Public Corresp.
85	157.275	161.875	Public Corresp.
86	157.325	161.925	Public Corresp.
87	157.375	161.975	Public Corresp.
88A	157.425	157.425	Comm'l-Intership only

Transmitting is disabled.

* 1W only

** Bridge to bridge 1 watt initially. Can be switched to high power (25W) while [1/25/DIM] key is being pressed.

*** These channels are not for use by the general public in U.S. waters.

A Simplex operation on a channel designated internationally as a duplex channel.

VHF Weather Channel Frequencies

USA Version:

CH	Receive Freq.	Service
WX0	163.275	NOAA Weather
WX1	162.550	NOAA Weather
WX2	162.400	NOAA Weather
WX3	162.475	NOAA Weather
WX4	162.425	NOAA Weather
WX5	162.450	NOAA Weather
WX6	162.500	NOAA Weather
WX7	162.525	NOAA Weather
WX8	161.650	Canadian Weather
WX9	161.775	Canadian Weather

(Transmitting is disabled when WX0 - WX9 is displayed.)

Caution

Operation on channels not designated for use by your classification of craft or on International Channels within US territorial waters is a violation of FCC Rules and Regulations and may result in severe penalties.

7-2. Block Diagram

