

KENWOOD

SERVICE MANUAL

Model TS-670

FM-430, GC-10, VS-1

ALL MODE QUAD BANDER

MASTER COPY

Tel. (UK) 2430 or 2817
Telex 377482 Lowtec G

Matfor
Perth 4 SLE

Bentley Bridge
Chester Road

LOWE ELECTRONICS



CONTENTS

| | | | |
|----------------------------------|----|-------------------------|----|
| SPECIFICATIONS..... | 2 | ADJUSTMENT..... | 22 |
| CIRCUIT DESCRIPTION | 3 | PACKING..... | 31 |
| PARTS LIST | 11 | LEVEL DIAGRAM | 34 |
| PC BOARD VIEW..... | 18 | BLOCK DIAGRAM | 35 |
| SWITCH UNIT (X41-1550-00)..... | 18 | DISASSEMBLY | 36 |
| RF UNIT (X44-1580-00)..... | 19 | TERMINAL FUNCTION | 38 |
| IF UNIT (X48-1390-00) | 20 | OPTION..... | 42 |
| CONTROL UNIT (X53-1370-00) | 21 | GC-10..... | 42 |
| FINAL UNIT (X45-1350-00) | 22 | FM-430..... | 46 |
| FILTER UNIT (X51-1320-00) | 22 | VS-1 | 48 |
| DISPLAY UNIT (X54-1800-00) | 22 | SCHEMATIC DIAGRAM..... | 47 |
| ENCODER UNIT (W02-0328-10)..... | 22 | | |

TS-670

SPECIFICATIONS

[General]

Transmit/receive frequency range:

40 m band: 7.0 — 7.1 MHz
15 m band: 21.0 — 21.45 MHz
10 m band: 28.0 — 29.7 MHz
6 m band: 50.0 — 54.0 MHz

Mode:

SSB (A3J), CW (A1), AM (A3) and FM (F3-option)
(50 MHz band only for AM transmission.)

Antenna impedance: 50 Ω **Supply voltage:** 12 — 16 V DC

(Reference voltage: 13.8 V DC)

Power consumption:

Approx. 4 A at transmission
Approx. 1.1 A at reception with no signal

Dimensions: 270W(279) × 96H(108) × 260D(298) mm

Dimensions in () are the maximum, including projections.

Weight: 5.4 kg

[Transmitter]

Final power input: SSB, CW, FM 10 W
AM 4 W
(50 MHz band only)

Modulation :

SSB: Balanced modulation
FM : Variable reactance direct shift
AM : Low level modulation

Carrier suppression: Better than 40 dB**Unwanted sideband suppression:** Better than 50 dB**Unwanted radiation intensity:**

7, 21, 28 MHz bands : Less than -40 dB
50 MHz band : Less than -60 dB
21 MHz band 5th higher harmonic: Less than -70 dB
50 MHz band 2nd higher harmonic: Less than -70 dB

Transmission frequency response (SSB): 400 — 2600 Hz
(better than -6 dB)**Maximum frequency deviation (FM):** ± 5 kHz
(FM-430 installed)**Microphone impedance:** 500 Ω — 50 k Ω

[Receiver]

Circuitry: SSB, CW, AM : Single superheterodyne
: Double superheterodyne

Intermediate frequency: SSB, CW, AM: 8.83 MHz
FM: 1st IF 8.83 MHz
: 2nd IF 455 kHz

Sensitivity:

SSB, CW (10 dB S/N) : Less than -12 dB μ (0.25 μ V)
AM (10 dB S/N) : Less than 6 dB μ (2 μ V)
FM (30 dB S/N) : Less than 0 dB μ (1 μ V)
(12 dB SINAD) : Less than -8 dB μ (0.4 μ V)
With YK-88A inserted in AM mode.
With FM-430 inserted in FM mode.

Squelch sensitivity:

FM (28.50 MHz band) : Less than -10 dB μ (0.32 μ V)
SSB, CW, AM : Less than 10 dB μ (3.2 μ V)

Image ratio: More than 50 dB**IF reflection:** More than 50 dB**Selectivity:**

| | -6 | -60 dB |
|---------|---------|--------|
| SSB, CW | 2.5 kHz | 6 kHz |
| AM* | 6 kHz | 11 kHz |
| FM** | 12 kHz | 22 kHz |

* With YK-88A inserted.

** With FM-430 inserted.

RIT variable range: More than ± 1.2 kHz**Audio output power:** More than 1.5 W

(with 8 Ω load, 10% distortion)

Audio output impedance: 8 — 16 Ω

[Frequency Controller]

Frequency accuracy:

Within $\pm 10 \times 10^{-6}$ at room temperature
Within $\pm 30 \times 10^{-6}$ at 0°C — +50°C

Frequency stability (at reception):

Within $\pm 30 \times 10^{-6}$ at 0°C — +50°C.
Within ± 300 Hz for up to 60 minutes after turn-on, and
within 30 Hz for any 30 minute period thereafter.

- Circuitry and ratings are subject to change without notice due to developments in technology.
- GC-10, VS-1, VOX-4, FM-430, MB-430, SP-430 and PS-20 are optionally available.

CIRCUIT DESCRIPTION

OUTLINE

The TS-670 is a single conversion 4-band transceiver having an intermediate frequency of 8.83 MHz. In the FM reception mode double conversion at 455 KHz is employed.

The Phase Locked Loop (PLL) uses a digital variable frequency oscillator (VFO) control system at a 10 and 100 Hz step switching rate in all modes but FM, in which 10 KHz and 100 KHz switching is automatically selected by the transceivers microprocessor. Excluding only the FM receiver second conversion oscillator, all oscillator frequencies generated in this device are including the carrier injection frequencies controlled by and synthesized from a single reference frequency source of 24 MHz.

The main auxiliary functions include two VFOs, 80-channel memory, frequency specify function, memory scan, program scan, IF shift, RIT, NB, power control and other useful functions.

RECEPTION CIRCUIT CONFIGURATION

The TS-670 reception system uses a single conversion at IF 8.83 MHz in SSB, CW and AM modes. In the FM mode, double conversion is used with a second IF at 455 kHz.

The RF stage is divided into 50 MHz, 7 MHz, 21 MHz and 28 MHz, while the stage following the mixer is common.

The signal received by the antenna is fed through the Low Pass Filter (LPF) (common for both transmission and reception), which is relay switched according to band, and antenna relay RL1 on the Filter unit before being input to the RF unit PA terminal.

The signal is fed through broad-band transformer T1, RF attenuating relay RL2, 8.83 MHz trap T2 and T3, IF traps L2 to L4, and for 50 MHz Band, the signal is stepped up by antenna coil T4 and T5. It is then amplified by RF amp Q1 (2SK74 (L)) and fed through Band Pass Filter (BPF) T6 to T8 before being output from buffer amp Q2. HF signals are stepped up by broadband transformer T9, and then fed through either a 7, 21, or 28 MHz BPF : 7 MHz; T12, T15 and T18. 21 MHz; T11, T14 and T17. 28 MHz; T10, T13 and T16. It is then amplified by RF amp Q3 (3SK74 (L)) before being output from buffer amp Q4.

Both 50 MHz and HF signals are converted a balanced signal by broad-band transformer T20, then mixed with the local oscillator by common mixers Q5 and Q6 (3SK122(L) x 2) to become an 8.83 MHz intermediate frequency signal T19 is an 8.83 MHz trap.

This signal is fed through ceramic filter CF1, then amplified by the first IF amp Q7 (3SK73 GR), and fed through Noise Blanker (NB) gate diode D17 through D20 before being output to the IF unit via the RIF terminal in the SSB, CW and AM modes. In the FM mode, the signal is first fed through buffer amp Q8, and is then output to the FM unit through the FMI terminal. The noise blanker samples from the output of ceramic filter CF1, feeds this through buffer amp Q11 (2SK192 (Y)), then amplifies this by Q12, Q13 and Q14 the noise component is detected by diodes D23 and D24 before

driving switching transistor Q15 to switch the NB gate.

The NB gate also serves as a blanking circuit to eliminate Phase Locked Loop (PLL) "click" noise when the Voltage Controlled Oscillator (VCO) resets (Q9 and Q10).

The signal from the RF unit RIF terminal is fed to the IF unit RIF terminal through matching transformer L1 and through mode-selected Monolithic Crystal Filters (MCFs), and is then amplified by IF amps Q1 and Q4 (3SK73).

The signal in SSB and CW modes is detected by product detector D26 through D29 (1N60), amplified by audio pre-amp Q7 which is common to each mode, and fed through squelch switching transistor Q8 before being output to the gain control.

In the FM mode, the signal is detected by diode D25, then passed through buffer amp Q6 before being fed to pre-amp Q7.

In FM mode, the signal is mixed, amplified and detected in the FM unit, then fed through the IF unit FAF terminal before being input to pre-amp Q7.

The audio input to this pre-amplifier is switched by either D30, for the SSB and CW modes, D32 for the AM mode or D31 for the FM mode.

TRANSMISSION CIRCUIT CONFIGURATION

Like the reception system, the transmission system uses single conversion in the SSB, CW and AM modes, and uses double conversion in the FM mode.

In the SSB, CW and AM modes, audio from the MIC input terminal is amplified by Q34 on the IF unit, then fed through the mic gain control, and further amplified by Q35 before being input to balanced modulator Q36 (AN612).

In the SSB mode, the output from this modulator is Double Side Band, and after passing through the Monolithic Crystal Filter (MCF) YK-88S3 becomes an SSB signal.

In the AM and CW modes, modulator balance is lost by applying the DC voltage to pin 1 of this modulator. At this time, the amount of carrier to be injected is determined by varying the DC bias current to pin diode D44 (MI204). In the AM mode, the output from Q36 is fed through R5 (680 ohm). (However, when AM filter YK-88A is mounted, the signal is also fed through this filter.) In the CW mode, the output is fed through SSB filter YK-88S3. Each mode signal fed through the filter is amplified by transmitter IF amp Q24, then output to the RF unit.

In the FM mode, the audio signal fed through mic amp Q34 which is commonly used is fed to the FM unit where the signal is FM-modulated using the 8831.5 kHz carrier frequency, the out-put of which is input to No. 1 transmitter balanced mixers Q24 and Q25 (3SK122 x 2) of the RF unit.

The switching between the SSB, CW, AM signals and the FM signal is performed by switching diodes D32 and D38.

The ALC (Automatic Level Control) is performed on transmitter IF amp Q42 of the IF unit.

The transmitter signal from the IF unit is mixed with band-wise VCO output at first transmitter balanced mixers Q24 and

TS-670

CIRCUIT DESCRIPTION

Q25, then branched into two signals; 50 MHz and 7, 21, 28 MHz signals. The 50 MHz signal is fed through BPF (T37 to T40), then amplified by transmitter amp Q29 (3SK73) and broad-band amplifiers Q30 and Q31 (2SC2086 x 2), and output as a 50 MHz signal. The 7, 21 and 28 MHz signals are fed through each band-wise BPF (common as in reception), then amplified by broad-band amp Q26 (3SK73), buffer amp Q27 and broad-band amp Q28 (2SC2086). The amplified 50 MHz signal and 7, 21 and 28 MHz signals

are switched by relay RL1, then become a drive output to the final unit.

The signal fed to the final unit is amplified by broad-band push-pull drive amps Q1 and Q2 (2SC1971 x 2), then further amplified by broad-band push-pull final amps Q3 and Q4 (2SC2509 x 2), and becomes a 10 W output. The RF output is fed through the band-wise LPFs in the filter unit, then fed to the antenna for output. The ALC and protection detection are performed at the antenna line after feeding through LPFs.

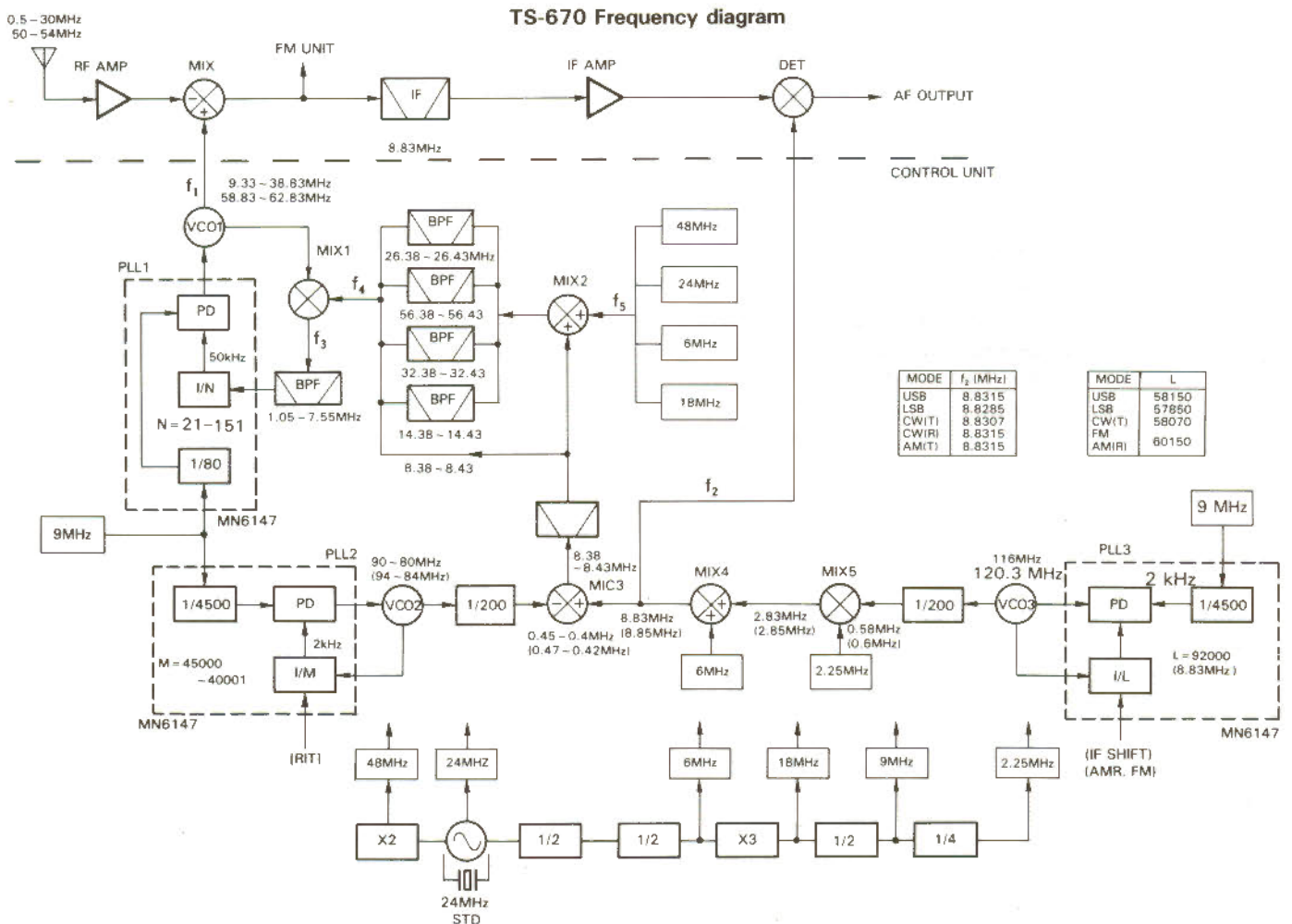

| Item | Rating |
|----------------------------|---|
| Center frequency f_0 | 8830.7 kHz |
| Center frequency deviation | $f_0 \pm 150$ Hz at 6 dB |
| 6 dB bandwidth | ± 250 Hz or more |
| 60 dB bandwidth | ± 900 Hz or less |
| Ripple | 2 dB or less |
| Loss | 6 dB \pm 2 dB |
| Guaranteed attenuation | 80 dB or more within $f_0 \pm 2$ kHz to ± 1 MHz |
| Input and output impedance | 600 Ω /15pF |

Table 1 CW crystal filter YK-88C (L71-0211-05) Option

| Item | Rating |
|----------------------------|---|
| Center frequency f_0 | 8830.7 kHz |
| Center frequency deviation | $f_0 \pm 50$ Hz at 6 dB |
| 6 dB bandwidth | ± 125 Hz or more |
| 60 dB bandwidth | ± 600 Hz or less |
| Ripple | 2 dB or less |
| Loss | 8 dB \pm 2 dB |
| Guaranteed attenuation | 80 dB or more within $f_0 \pm 2$ kHz to ± 1 MHz |
| Input and output impedance | 600 Ω /15pF |

Table 2 CW crystal filter YK-88CN (L71-0221-05) Option

CIRCUIT DESCRIPTION

PLL CIRCUIT

The PLL circuit of the TS-670 consists of 3 PLL circuits using a reference frequency of 24 MHz and all the frequencies are placed under the control of the 24 MHz reference oscillator. ICs 3, 4 and 13 are PLL ICs. A single package of these ICs (MN6147) contains the program divider, phase comparator, and frequency dividers for the reference signal.

The IC3 PLL has a reference comparison frequency of 2 kHz, and oscillates at 116 MHz (120 MHz during AM reception and FM reception). The 9 MHz signal obtained by dividing a 18 MHz signal by 2, the 3rd higher harmonic of 6 MHz which has been produced from a reference frequency of 24 MHz by dividing with 4, is further divided within the PLL to produce 2 kHz, which is in turn used as a reference comparison frequency. Frequency dividing ratios L are 58150 in USB, 57850 in LSB and 58070 in CW (during transmission) and 60150 during FM and AM (reception). The frequency dividing ratios are determined by the signals fed from data bus DB0 to DB3 of the CPU (IC19: TMP8049P-3034).

The 116 MHz (AM reception, FM 120 MHz) output is divided by a ratio $1/100 \times 1/2$ (IC5: M54459L, IC6-b: SN74LS112AN) to become 0.5815 MHz (0.6 MHz AM reception, FM) in USB mode, then mixed with a 2.5 MHz signal produced from the reference oscillator by MIX5 (IC7: SN161913P), fed through the BPF, and then mixed with the 6 MHz signal produced by the reference oscillator to obtain 8.8315 MHz in USB mode. This signal is fed through the buffer amp to become the CAR signal, and, on the other hand, it becomes a signal for other PLL. PLL IC4 has a reference comparison frequency of 2 kHz and oscillates at 90 to 80 MHz (AM reception, FM 94 to 84 MHz) in 2 kHz steps.

The 9 MHz signal obtained by the reference frequency is divided within the IC to produce a 2 kHz signal which is in turn used as a reference comparison frequency. The frequency dividing ratio M of the program divider is 45000 to 40001 and the frequency dividing setting signals for the IC are sent from data bus B0 to B3 of the CPU (IC19: TMP8049P-3034).

An output of 90 to 80 MHz (AM reception; FM 94 to 84 MHz) from VCO2 (Q24: 2SC1923) is divided by $1/100 \times 1/2$ (IC9: M54459L, IC6-a: SN74LS112AN) to become a 10 Hz step signal of 450 - 400 kHz (AM reception; FM 470 to 420 kHz). This signal is mixed with the 8.83 MHz PLL output of IC3 at MIX3 (IC10: SN16913P), then the resultant 8.38 to 8.43 MHz signal is fed through the ceramic filter and input to MIX2 (IC11: SN16913). This 8.38 to 8.43 MHz signal is either kept as it is or mixed with 48 MHz, 24 MHz, 6 MHz or 18 MHz signals generated by the reference oscillator, then input to the final PLL (IC13).

The final PLL IC13 oscillates at VCO frequencies (7, 21, 28 and 50 MHz amateur band frequencies plus 8.83 MHz) corresponding to respective amateur bands using a reference comparison frequency of 50 kHz. A reference comparison frequency of 50 kHz is obtained by dividing the 9 MHz signal generated from a reference frequency of 24 MHz within the PLL IC. Frequency dividing ratio N of the program divider is 31 to 151, and the frequency dividing ratio is given by data bus B0 to B3 of the CPU (IC19: TMP8049P-3034).

| | BAND | Frequency range | VCO (f_1) | (f_2) | (f_3) | (f_5) |
|-----|------|-----------------|------------------|---------------|------------------|-----------|
| ① | 05A | 0.5 ~ 1.8MHz | 9.33 ~ 10.63MHz | 5.05 ~ 3.8MHz | 14.38 ~ 14.43MHz | 6 MHz |
| ② | 2A | 1.8 ~ 4 MHz | 10.63 ~ 12.83MHz | 2.25 ~ 4.4MHz | 8.38 ~ 8.43MHz | — |
| ③ | 4A | 4 ~ 6.6MHz | 12.83 ~ 15.43MHz | 4.45 ~ 7 MHz | 8.38 ~ 8.43MHz | — |
| * ④ | 7A | 6.6 ~ 8 MHz | 15.43 ~ 16.83MHz | 1.05 ~ 2.4MHz | 14.38 ~ 14.43MHz | 6 MHz |
| ⑤ | 8A | 8 ~ 9.9MHz | 16.83 ~ 18.73MHz | 2.45 ~ 4.3MHz | 14.38 ~ 14.43MHz | 6 MHz |
| | 10A | 9.9 ~ 12 MHz | 18.73 ~ 20.83MHz | 4.35 ~ 6.4MHz | 14.38 ~ 14.43MHz | 6 MHz |
| ⑥ | 12A | 12 ~ 16 MHz | 20.83 ~ 24.83MHz | 5.55 ~ 1.6MHz | 26.38 ~ 26.43MHz | 18MHz |
| ⑦ | 16A | 16 ~ 21 MHz | 24.83 ~ 29.83MHz | 7.55 ~ 2.6MHz | 32.38 ~ 32.43MHz | 24MHz |
| * ⑧ | 21A | 21 ~ 24.8MHz | 29.83 ~ 33.63MHz | 3.45 ~ 7.2MHz | 26.38 ~ 26.43MHz | 18MHz |
| * ⑨ | 28A | 24.8 ~ 30 MHz | 33.63 ~ 38.83MHz | 1.25 ~ 6.4MHz | 32.38 ~ 32.43MHz | 24MHz |
| * ⑩ | 50A | 50 ~ 54 MHz | 58.83 ~ 62.83MHz | 2.45 ~ 6.4MHz | 56.38 ~ 56.43MHz | 48MHz |

Note 1: * Mark, original installed (without GC-10)

Note 2: ⑤ Band has change VCO (f_1) only and RF has 8 ~ 12 MHz BPF.

TS-670

CIRCUIT DESCRIPTION

The VCO consists of Q17, Q18, Q19 and Q20, and the VCO frequencies corresponding to 7, 21, 28 and 50 MHz are mixed with either one of the five corresponding frequencies 14.38 - 14.43 MHz, 32.38 - 32.43 MHz, 56.38 - 56.43 MHz, and 26.38 - 26.43 MHz (8.38 - 8.43 MHz is used when the general coverage unit is incorporated) generated by the previous MIX2, then fed through the BPF

and input to the PLL IC where phase is compared with the 50 kHz signal obtained by using dividing ratio N of 31 to 151.

When the optional general coverage unit (GC-10) is incorporated, the outputs from the six VCOs within the GC-10 are fed to MIX1 where phase is compared with the 50 kHz signal just as in amateur bands.

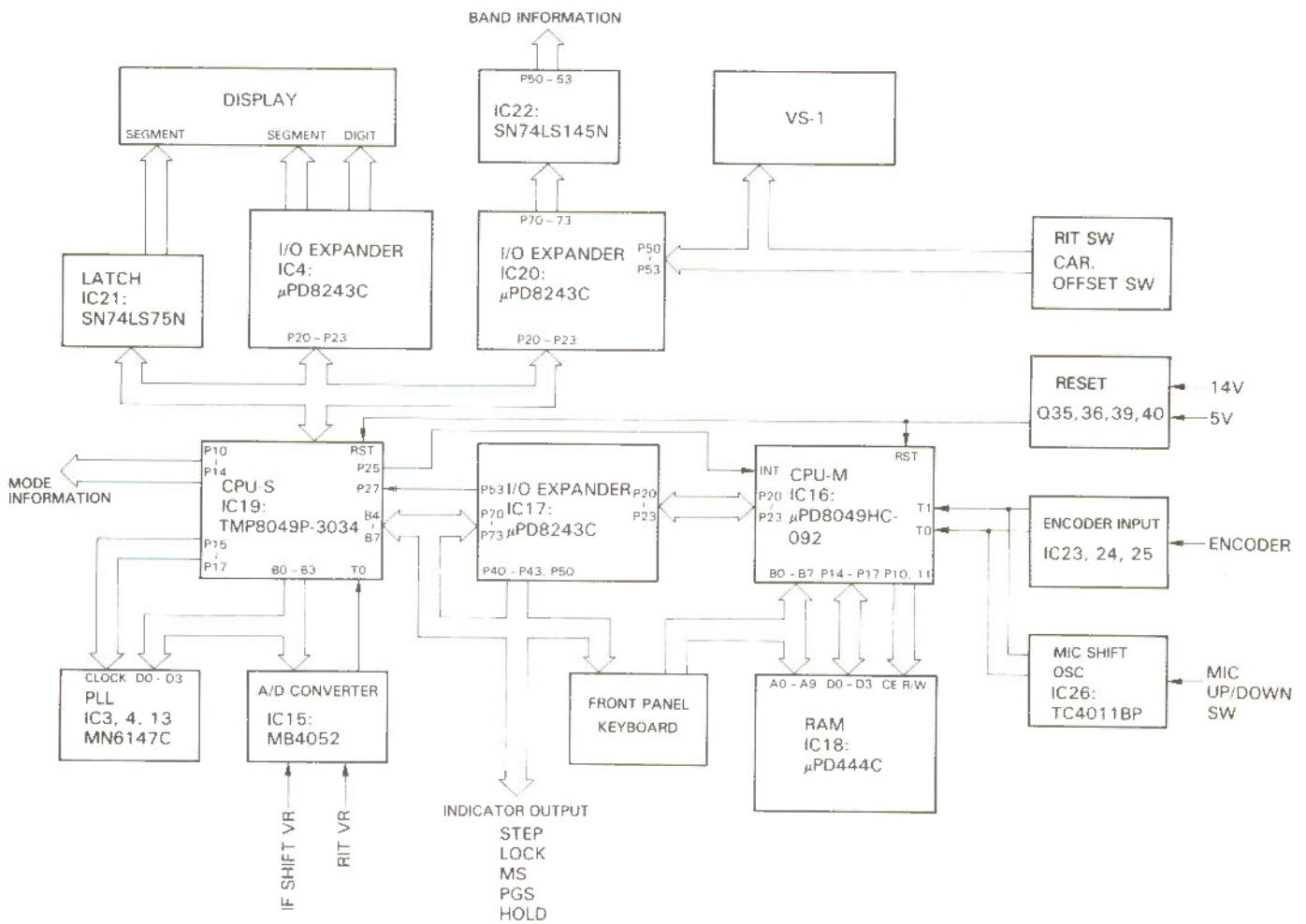

TS-670 CONTROL BLOCK diagram

| Item | Rating |
|----------------------------|--------------------------|
| Center frequency (f_0) | 8831.5 kHz \pm 250 kHz |
| -6 dB bandwidth | 6 kHz |
| Attenuation bandwidth | 11 kHz |
| Guaranteed attenuation | 80 dB or more |
| Ripple | 2 dB or less |
| Loss | 3 dB \pm 2 dB |
| Input and output impedance | 600 Ω /15pF |
| Temperature | -10°C ~ +50°C |

Table 3 AM crystal filter YK-88A (L71-0223-05) Option

| Item | Rating |
|-----------------------------------|---|
| Normal center frequency (f_0) | 8.830 MHz |
| 3 dB bandwidth | $f_0 \pm 5$ kHz or more, total 25 kHz or more |
| 20 dB bandwidth | 90 kHz or less |
| Ripple (Within 3 dB bandwidth) | 1 dB or less |
| Spurious response | 14 dB or more within $f_0 \pm 1.5$ MHz |
| Input and output impedance | 330 Ω |

Table 4 Ceramic filter (L72-0324-05) SFE8.83MF (RF unit, CF1)

CIRCUIT DESCRIPTION

DIGITAL CONTROL CIRCUIT

The controller of the TS-670 uses two 8-bit microprocessors (μ PD8049HC-092, and TMP8049P-3034), and its peripheral circuits consist of three I/O expander ICs (μ PD8243C), externally connected RAM (μ PD444C), etc.

The two CPUs are connected with each other via 4-bit data bus and 2-bit control bus for data interchange.

The microprocessor clock operates at 8.1 MHz, which is oscillated by CPU-S (IC19). The clock pulse is also fed to the other CPU-M (IC16).

The CPU-M (IC16) performs decision and arithmetic operations with which to select the operating state of the unit, using the data from various switches on the panel and encoders, etc., determining the operating frequencies and modes. The determined frequencies and mode data are stored in the externally connected RAM (IC18) and at the same time transferred to the CPU-S (IC19).

To the CPU-M, the I/O expander IC17 is connected, from which control signals for various indicators are output and to which data from the keyboard switches on the front panel is input in matrixed form.

The CPU-S provides the digital frequency display based on the input frequency and mode data, and calculates frequency dividing ratio for each PLL circuit, then set data at PLL ICs (IC3, IC4 and IC13). At the same time, in order to control the

external circuits, the CPU-S also outputs mode data and band data. The band data is output in 5-bit data consisting of 4-bit BCD and 1 bit. The 4-bit BCD data is fed through IC22 (SN74LS145N) where it is divided into 10 bands, and a total of 11-band data is output.

The encoder input circuit consists of the OR, exclusive NOR and NAND gates of IC23, IC24 and IC25; the input 250 pulses/revolution clock rate is multiplied by 4 to become 1000 pulses. The IC25 (TC4011BP) flip-flop circuit detects the direction of revolution of the rotary encoder.

The non-stable multivibrator IC26 (TC4011BP) is an oscillatory circuit for frequency shift by the mic UP/DOWN switch and operates at approx. 55 Hz; this oscillatory frequency determines the shift speed. However, a 1-step feed has nothing to do with this oscillator but is internally processed by the microprocessor.

The RIT and IF shift of the TS-670 are varied by using potentiometers; these can be varied digitally in 10 Hz steps. In RIT mode, the actual frequency is also displayed. The DC voltages preset by potentiometers are divided into approx. 0 to 2.5 V by voltage dividers, then input to the A/D converter (IC15: MB4052) where the signals are converted into the 8-bit (256 steps) data before being input to the CPU-S, varying the frequency dividing ratio of the PLL circuit for control.

μ PA80C MAX Rating

| Item | Symbol | Condition | Rating |
|----------------------|-----------|------------|--------------|
| Power voltage | V_{SS} | -60 | V |
| Input voltage | V_I | -20 | V |
| Output current | I_O | 50 | mA/unit |
| Ross | P_r | 550 | mW |
| Operating case temp. | T_{op} | -25 ~ +75 | $^{\circ}$ C |
| Storage temp. | T_{stg} | -40 ~ +125 | $^{\circ}$ C |

| Item | Rating |
|---------------------------------|--|
| Center frequency f_0 | 455 kHz |
| 3 dB bandwidth | $f_0 \pm 4.2$ kHz or more |
| 6 dB bandwidth | $f_0 \pm 6$ kHz or more |
| 60 dB bandwidth | $f_0 \pm 12$ kHz or less |
| Ripple (With $f_0 \pm 4.2$ kHz) | 3 dB or less |
| Loss | 6 dB or less |
| Guaranteed attenuation | 50 dB or more within $f_0 \pm 100$ kHz |
| Spurious | 25 dB or more within 0.1 MHz to 1 MHz |
| Input and output impedance | 1.5 k Ω |

Table 5 FM crystal filter CFV455F (L72-0342-05)
(FM UNIT, CF1)

μ PA80C Block diagram

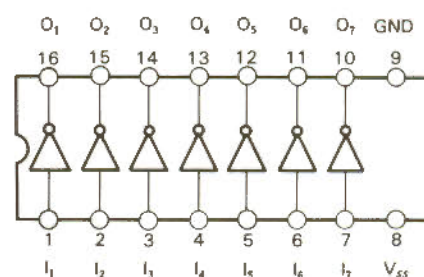

| Item | Rating |
|----------------------------|---|
| Center frequency f_0 | 8830 kHz |
| Center frequency deviation | $f_0 \pm 150$ Hz at 6 dB |
| 6 dB bandwidth | ± 1.2 kHz or more |
| 60 dB bandwidth | ± 3.3 kHz or less |
| Ripple | 2 dB or less |
| Loss | 6 dB or less |
| Guaranteed attenuation | 80 dB or more within $f_0 \pm 3$ kHz to ± 1 MHz |
| Input and output impedance | 600 Ω /15pF |

Table 6 CW crystal filter YK-88S3 (L71-0245-05)
(IF UNIT, XF1)

TS-670

CIRCUIT DESCRIPTION

CPU-M IC6 (μ PD 8049HC-092) Terminal function

| Terminal No. | Symbol | Explanation | Terminal No. | Symbol | Explanation |
|--------------|---------|---|--------------|-----------------|------------------------------------|
| 1 | TO | Encoder UP/DOWN signal input | 21 | P20 | I/O EXPANDER control output (IC17) |
| 2 | X'tal 1 | Microcomputer clock input | 22 | P21 | |
| 3 | X'tal 2 | | 23 | P22 | |
| 4 | RESET | Microcomputer reset input. Normally "H" | 24 | P23 | |
| 5 | SS | Normally "H" | 25 | PROG | |
| 6 | INT | CPU-S control input | 26 | V _{DD} | 5V Power supply |
| 7 | EA | Normally "L" | 27 | P10 | RAM CE output |
| 8 | RD | Open | 28 | P11 | RAM R/W output READ: H WRITE: L |
| 9 | PSEN | | 29 | P12 | 1MHz STEP SW input OFF: H ON: L |
| 10 | WR | | 30 | P13 | POWER DOWN input NORM: H |
| 11 | ALE | Data input | 31 | P14 | RAM Data IN/OUTPUT |
| 12 | DB 0 | | 32 | P15 | |
| 13 | DB 1 | | 33 | P16 | |
| 14 | DB 2 | | 34 | P17 | |
| 15 | DB 3 | | 35 | P24 | RAM Address output (A8) |
| 16 | DB 4 | | 36 | P25 | RAM Address output (A9) |
| 17 | DB 5 | | 37 | P26 | Encoder F.F. Reset output |
| 18 | DB 6 | RAM address output (A0 - 7) | 38 | P27 | TX signal input TX: L RX: H |
| 19 | DB 7 | | 39 | T 1 | Encoder clock output |
| 20 | GND | | GND terminal | 40 | V _{CC} |

CPU-S IC19 (TMP8049P-3034) Terminal function

| Terminal No. | Symbol | Explanation | Terminal No. | Symbol | Explanation | |
|--------------|---------|--|---------------------------|-----------------|------------------------------------|--------------------------|
| 1 | TO | A/D converter input | 21 | P20 | I/O EXPANDER control output (IC20) | |
| 2 | X'tal 1 | Microcomputer clock OSC | 22 | P21 | | |
| 3 | X'tal 2 | | 23 | P22 | | |
| 4 | RESET | Microcomputer reset input. Normally "H" | 24 | P23 | LATCH IC data output | |
| 5 | SS | Normally "H" | 25 | PROG | 5V Power supply | |
| 6 | INT | Display dynamic drive clock input (1kHz) | 26 | V _{DD} | | |
| 7 | EA | Normally "L" (GND) | 27 | P10 | | |
| 8 | RD | Open | 28 | P11 | | MODE output Normally "H" |
| 9 | PSEN | | 29 | P12 | | |
| 10 | WR | | 30 | P13 | | |
| 11 | ALE | 31 | P14 | | | |
| 12 | DB 0 | PLL dividing ratio output | 32 | P15 | PLL 1 clock output (IC13) | |
| 13 | DB 1 | | 33 | P16 | PLL 2 clock output (IC4) | |
| 14 | DB 2 | | 34 | P17 | PLL 3 clock output (IC3) | |
| 15 | DB 3 | A/D control output | 35 | P24 | LATCH output | |
| 16 | DB 4 | Data input | 36 | P25 | CPU-M control output | |
| 17 | DB 5 | | 37 | P26 | EXPANDER CHIP SELECT output | |
| 18 | DB 6 | | CPU-M control bus (input) | 38 | P27 | CPU-M control input |
| 19 | DB 7 | | 39 | T 1 | PLL UNLOCK input NOR: H UNLOCK: L | |
| 20 | GND | GND terminal | 40 | V _{CC} | 5V Power supply | |

CIRCUIT DESCRIPTION

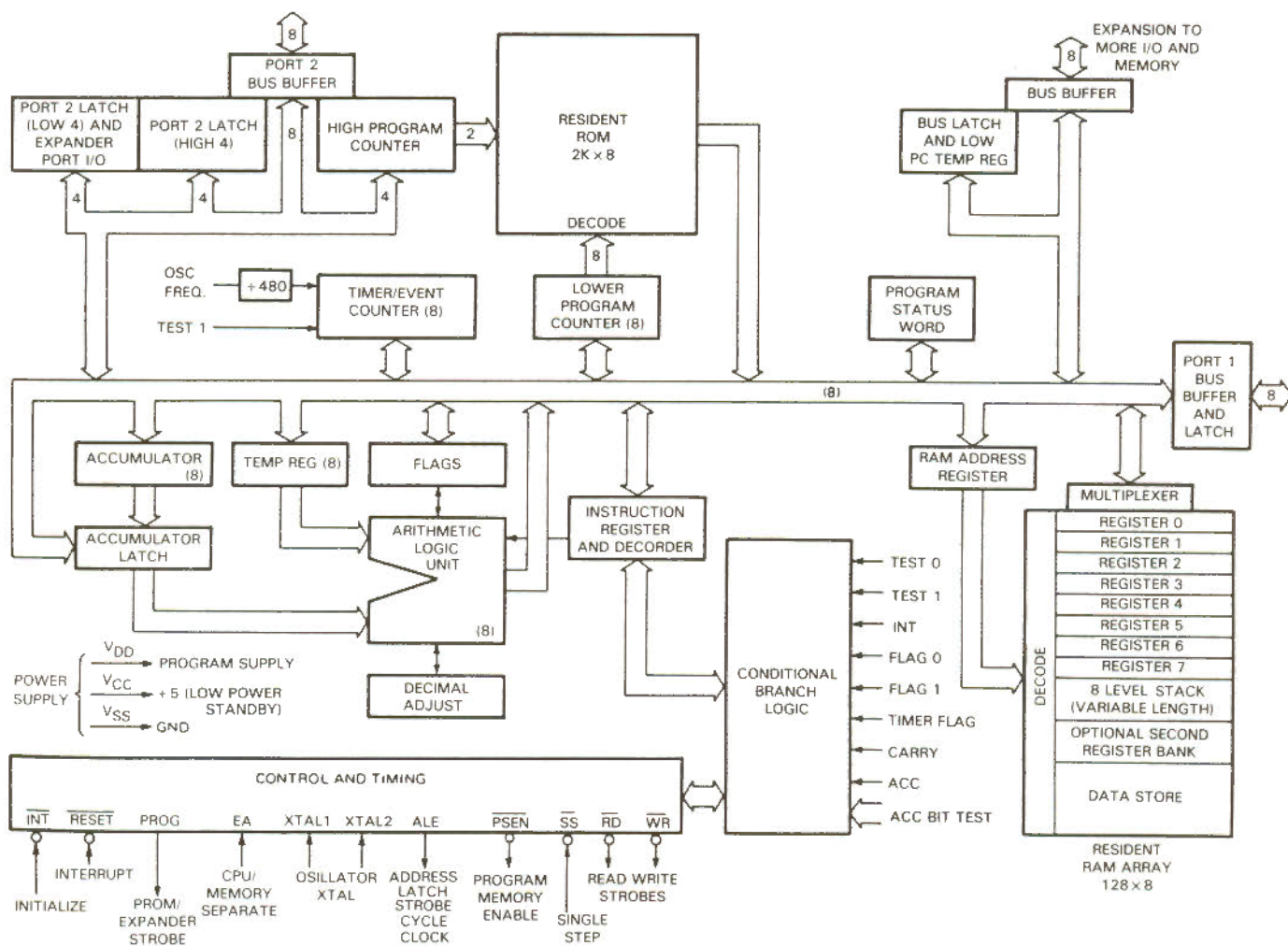

μPD8049HC-092/TM8049P-3034 Block diagram

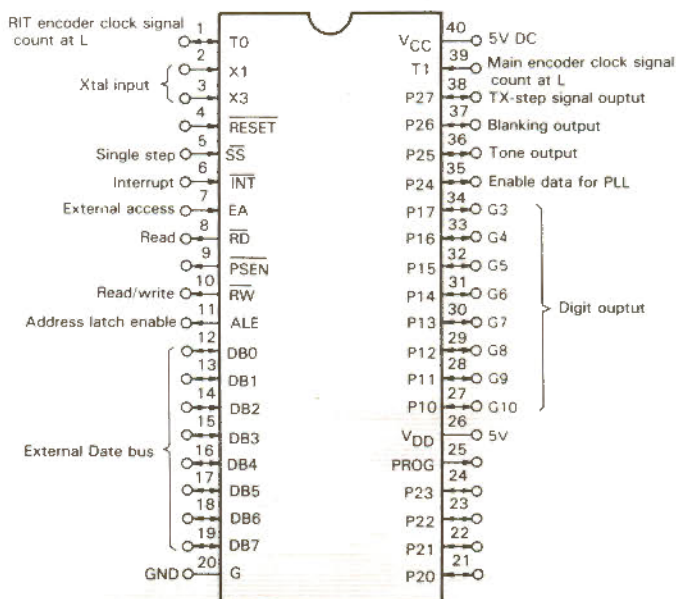

μPD8049HC-092/TMP8049P-3034 Terminal name

TS-670

CIRCUIT DESCRIPTION

MB4052 Terminal name (TOP VIEW)

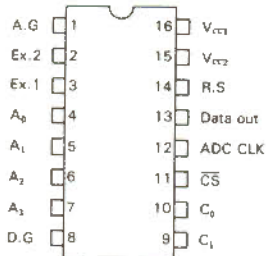

MB4052 Block diagram

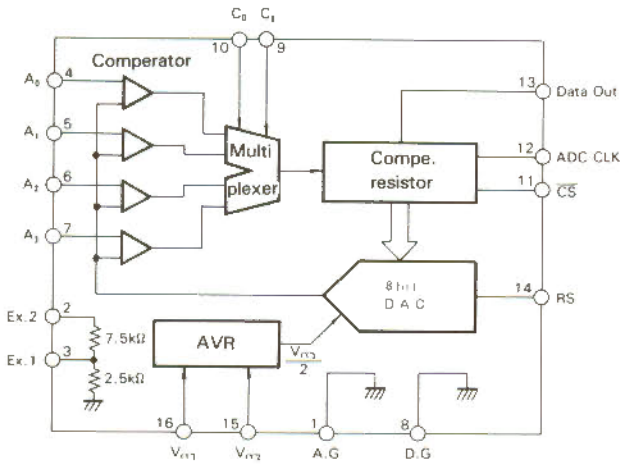

MB4052 Wave form

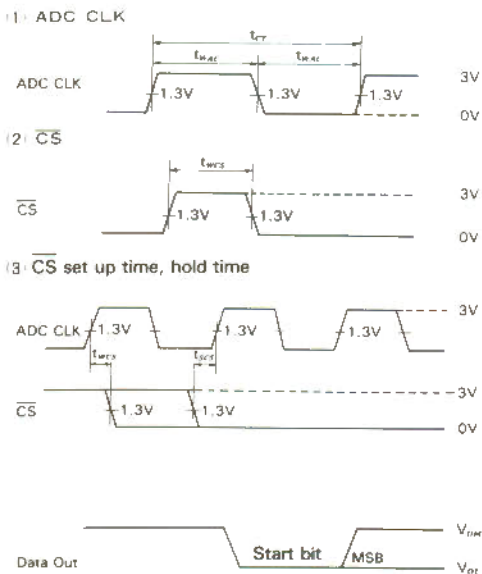

TC4071BP Max rating

| Item | Symbol | Rating | Unit |
|-----------------------------|-----------|----------------------------------|------|
| Operating voltage | V_{DD} | $V_{SS} - 0.5 \sim V_{SS} + 20$ | V |
| Input voltage | V_{IN} | $V_{SS} - 0.5 \sim V_{DD} + 0.5$ | V |
| Output voltage | V_{OUT} | $V_{SS} - 0.5 \sim V_{DD} + 0.5$ | V |
| Input current | I_{IN} | ± 10 | mA |
| Packaged loss | P_D | 300 | mW |
| Operating temperature | Tstg | -65 ~ 150 | °C |
| Soldering time, temperature | Tsol. | 260°C·10sec | |

TC4071BP Block diagram

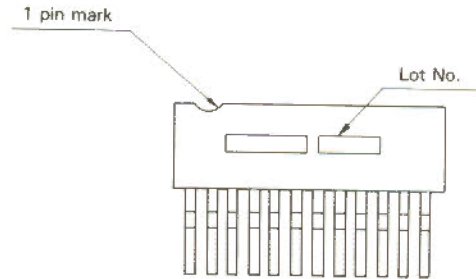

TA57 Max rating (Ta = 25°C)

| Item | Symbol | Rating |
|---------------------------|-----------|--------------|
| Collector-Base voltage | V_{CBO} | -75V |
| Collector-Emitter voltage | V_{CER} | -75V* |
| Emitter-Base voltage | V_{EB0} | -5V |
| Collector current | I_C | -50mA |
| Collector loss | P_C | 50mW/element |
| Junction temperature | Tj | 125°C |
| Operating temperature | Tstg | -55 ~ 125°C |

* $R_{th} = 10k\Omega$

TA57 Terminal diagram

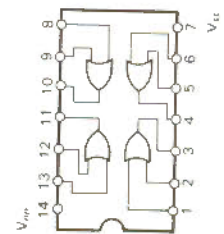

14) channel set up time

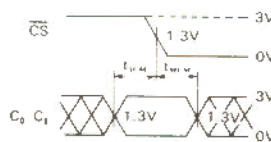

15) Pulse delay timing

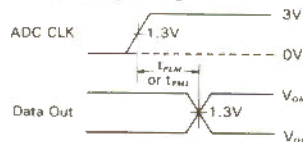

CAPACITORS

CC 45 TH 1H 220 J
 1 2 3 4 5 6

- 1 = Type ... ceramic, electrolytic, etc
- 2 = Shape ... round, square, etc
- 3 = Temp coefficient
- 4 = Voltage rating
- 5 = Value
- 6 = Tolerance

● Temperature coefficient

| 1st Word | C | L | P | R | S | T | U |
|----------|-------|-----|--------|--------|-------|------|--------|
| Color* | Black | Red | Orange | Yellow | Green | Blue | Violet |
| ppm/°C | 0 | -80 | -150 | -220 | 330 | -470 | -750 |

| 2nd Word | G | H | J | K | L |
|----------|------|------|-------|-------|-------|
| ppm/°C | ± 30 | ± 60 | ± 120 | ± 250 | ± 500 |

Example CC45TH = -470 ± 60 ppm/°C

● Tolerance

| Code | C | D | G | J | K | M | X | Z | P | No code |
|------|--------|-------|-----|-----|------|------|------|------|-------|---|
| (%) | ± 0.25 | ± 0.5 | ± 2 | ± 5 | ± 10 | ± 20 | + 40 | + 80 | + 100 | More than 10µF - 10 ~ + 50 Less than 4.7µF - 10 ~ + 75 |
| | | | | | | | 20 | - 20 | - 0 | |

Less than 10 pF

| Code | B | C | D | F | G |
|------|-------|--------|-------|-----|-----|
| (pF) | ± 0.1 | ± 0.25 | ± 0.5 | ± 1 | ± 2 |

| Abbreviation | | Abbreviation | |
|--------------|--------------|--------------|----------|
| Cap | Capacitor | ML | Mylar |
| C | Ceramic | S | Styren |
| E | Electrolytic | T | Tantalum |
| MC | Mica | | |

Resistors not listed in this parts list are standard, fixed carbon composition, 1/4W or 1/8W. The resistance values, in ohms, are indicated on the schematic diagram.

● Rating voltage

| 2nd word 1st word | A | B | C | D | E | F | G | H | J | K | V |
|----------------------|------|------|------|------|------|------|------|------|------|------|----|
| 0 | 1.0 | 1.25 | 1.6 | 2.0 | 2.5 | 3.15 | 4.0 | 5.0 | 6.3 | 8.0 | - |
| 1 | 10 | 12.5 | 16 | 20 | 25 | 31.5 | 40 | 50 | 63 | 80 | 35 |
| 2 | 100 | 125 | 160 | 200 | 250 | 315 | 400 | 500 | 630 | 800 | - |
| 3 | 1000 | 1250 | 1600 | 2000 | 2500 | 3150 | 4000 | 5000 | 6300 | 8000 | - |

● Capacitor value

- 0 1 0 = 1pF
 - 1 0 0 = 10pF
 - 1 0 1 = 100pF
 - 1 0 2 = 1000pF = 0.001µF
 - 1 0 3 = 0.01µF
 - 2 2 0 = 22pF
- 1st number | Multiplier
2nd number

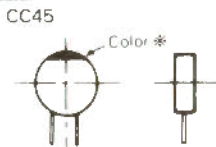

| Symbol | Destination |
|--------|----------------|
| K | U.S.A. |
| W | Europe |
| T | Britain |
| M | General market |

PARTS LIST

SEMICONDUCTORS

N : New parts

* : Please note that parts are sometimes not in stock and it takes much time to deliver.

| Item | Re- marks | Name | Item | Re- marks | Name | Item | Re- marks | Name | Item | Re- marks | Name | Item | Re- marks | Name |
|----------------|--------------|---|-------------|--------------|---|----------|--------------|--|------------|--------------|---|------|--------------|--|
| Diode | | BA282 IN60 IS1007 IS1587 IS2208 IS2588 ISS101 ISS133 ISS1555 1TT310TE MC921 M1204 MV13 MV203 V06B | Zener Diode | | MTZ3.9JA MTZ4.3JA MTZ6.2JA MTZ7.3JC MTZ7.5JA MTZ8.2JB MTZ9.1JB MTZ10JA MTZ12JB WZ071 | | | 2SC496(Y) 2SC1775(E) 2SC1815(Y) 2SC1907 2SC1923(O) 2SC1959(Y) 2SC1971 2SC2086 2SC2240(GR) 2SC2347 2SC2458(Y) 2SC2459(BL) 2SC2509 2SC2703(O,Y) 2SC2787(L) TA57 | Digital-TR | N | DTA114ES DTC114YS | | | MN6147C SN74LS11.2AN SN74LS75N SN74LS93N SN74LS145N SN16913P TA1061AP TC4011BP TC4071BP TMP8049P-3034 µPA80C µPC2002V µPD444C-0 µPD8049HC-092 µPD8243C |
| Vari-cap Diode | N | 1SV53A | Photo-diode | | LN66 | | | 2SA562(Y) 2SA733(R) 2SA1015(Y) 2SA1115(E) 2SC460(B) | IC | | AN612 AN7805 AN7808 LM358P M54459L MB3614 MB4052 MC3357P MC14077B | | | |
| | | | TR | N | | Photo-TR | | PN1265 | | N | | | | |

TS-670

| Parts No. | Re- marks | Description | Q'ty | Ref No. |
|---------------|--------------|-------------------------------|------|-------------|
| TS-670 | | | | |
| A01-0974-02 | | CASE (A) | 1 | |
| A01-0975-02 | | CASE (B) | 1 | |
| A20-2506-03 | N | PANEL | 1 | |
| B05-0708-04 | | SP GRILE | 1 | |
| B10-0664-04 | N | FRONT GLASS | 1 | |
| B30-0817-15 | | LAMP | 1 | |
| B31-0653-05 | N | METER | 1 | |
| B39-0407-04 | | SPACER FOOT | 2 | |
| B40-3501-04 | N | NAME PLATE KENWOOD | 1 | |
| B42-2378-04 | N | FCC PLATE | 1 | K type only |
| B43-1007-04 | N | BADGE KENWOOD | 1 | |
| B50-4115-00 | | INSTRUCTION MANUAL KENWOOD | 1 | |
| CE04W1A470M | | ELECTRO 47 10V | 1 | |
| CK45F1H103Z | | CERAMIC 0.01 50V | 2 | |
| CK45F1H473Z | | CERAMIC 0.047 50V | 1 | |
| D09-0306-04 | | | 1 | M type only |
| D09-0307-04 | | | 1 | M type only |
| D40-0626-15 | | MECHANISM ASS'Y | 1 | |
| ER2D03DK331 | | SERGE ABSORB | 2 | |
| E04-0152-05 | | RF COAXIAL CABLE RECEPTACLE | 2 | |
| E06-0751-05 | | CYLINDRICAL RECEPTACLE REMOTE | 1 | |
| E07-0852-05 | | VOLTAGE SELECTOR PLUG | 1 | M type only |
| E08-0203-25 | | VOLTAGE SELECTOR SOCKET | 1 | |
| E30-1648-05 | | DC CABLE ASS'Y | 1 | |
| E31-0431-05 | | SPEAKER CABLE | 1 | |
| E31-2161-05 | | INSIDE CONNECTING WIRE | 1 | M type only |
| E40-0474-05 | | PIN ASS'Y | 1 | M type only |
| F05-4022-05 | | FUSE(4A) | 1 | |
| F05-4022-05 | | FUSE(4A) | 1 | |
| F10-1302-12 | N* | SHIELDING PLATE | 1 | |
| F11-0858-03 | N | SHIELDING CASE | 1 | |
| F15-0653-04 | N | SHADE | 1 | |
| G02-0505-05 | | KNOB FITTING HARDWARE SPRING | 3 | |
| G09-0405-05 | | SPRING | 1 | |
| G11-0613-04 | N | SOFT TAPE VFO | 1 | |
| G11-0609-04 | | SOFT TAPE MIC | 2 | M type only |
| G13-0666-04 | | CUSHION PANEL | 2 | |
| G13-0649-04 | | MOUNTING HARDWARE METER | 2 | |
| G53-0511-04 | | PACKING | 4 | |
| H01-4547-04 | | CARTON CASE (OUT) | 1 | |
| H03-2177-04 | | CARTON CASE (IN) | 1 | |
| H10-2508-02 | N | POLYSTYRENE FOAM (F) | 1 | |
| H10-2509-02 | N | POLYSTYRENE FOAM (R) | 1 | |
| H12-1315-04 | | | 1 | |
| H25-0079-04 | | BAG 200X200 | 1 | M type only |
| J02-0323-05 | | FOOT BOTTOM CASE | 4 | |
| J02-0407-04 | | FOOT METAL | 1 | |
| J02-0403-04 | | FOOT RUBBER | 4 | |
| J30-0534-04 | | SPACER (PLATE TYPE) | 2 | |
| J31-0141-04 | | COLLAR MIC | 1 | |
| J32-0781-04 | N | BOSS 11.5CM | 4 | |
| J32-0782-04 | N | BOSS 11CM | 2 | |
| J32-0786-04 | N | BOSS 8.5CM POWER SW | 2 | |
| J61-0019-05 | | VINYL TIE | 5 | |
| J61-0408-05 | | VINYL TIE | 5 | |
| K01-0410-05 | | HANDLE | 1 | |
| K21-0768-04 | | MAIN KNOB | 1 | |
| K23-0710-04 | | KNOB AF RIT MIC | 3 | |
| K23-0721-04 | | KNOB SQL | 1 | |
| K27-0467-04 | N | KNOB BAND | 2 | |
| K29-0741-24 | | KNOB RF GAIN,IF SHIF | 3 | |
| K29-0758-04 | | KNOB POWER | 1 | |
| K29-3001-04 | N | KNOB 1MHZ RIT SEND | 5 | |

| Parts No. | Re- marks | Description | Q'ty | Ref No. |
|----------------------------------|--------------|-------------------------------|------|----------------|
| K29-3002-04 | N | KNOB VOICE NB ALC | 3 | |
| K29-0771-04 | | KNOB MAIN RING | 1 | |
| LM358P | | IC | 1 | |
| LN01201C | N | DIODE RED | 2 | |
| LN01301C | N | DIODE GREEN | 5 | |
| LN01401C | N | DIODE UMBER | 4 | |
| LN66(R) | | DIODE | 2 | |
| N09-0256-05 | | SCREW | 4 | |
| N09-0682-04 | N | SCREW (ACS. MOUNTING BRACKET) | 1 | |
| N09-0646-04 | | SCREW M4X4 | 2 | |
| N14-0509-05 | | NUT GND | 1 | |
| N14-0115-05 | | NUT GND | 1 | |
| N15-1040-46 | | FLAT WASHER GND | 2 | |
| N30-2004-46 | | PAN HD SCREW | 2 | |
| N30-2604-46 | | PAN HD SCREW | 4 | |
| N32-2604-46 | | FLAT HD SCREW | 6 | |
| N32-2606-46 | | FLAT HD SCREW | 10 | |
| N32-3006-46 | | FLAT HD SCREW | 2 | |
| N33-3006-41 | | ROUND FLAT SCREW | 4 | |
| N33-3006-45 | | ROUND FLAT SCREW | 4 | |
| N35-3004-41 | | BIND SCREW | 16 | |
| N35-3006-46 | | BIND SCREW | 2 | |
| N87-2608-46 | | TAPPING SCREW | 2 | |
| N87-3006-41 | | TAPPING SCREW | 6 | |
| N87-3006-46 | | TAPPING SCREW | 16 | |
| N87-3012-46 | | TAPPING SCREW | 29 | |
| N88-2605-46 | | | 2 | |
| N88-3006-46 | | FLAT TAPPING SCREW | 12 | |
| PN126S | | PHOTO TRANSISTOR | 2 | |
| RS14AB3A100J | | METAL FILM 10 OHM 1W | 1 | |
| R12-2411-05 | | SEMI FIXED | 2 | |
| S31-2045-05 | | | 1 | |
| S40-2437-05 | | PUSH SW POWER | 1 | |
| S50-1406-05 | | TACT SW(TCH(UP,DOWN) | 2 | |
| S59-0421-05 | N | KEYBOARD SWITCH | 1 | M type only |
| T03-0027-15 | | SPEAKER | 1 | |
| T91-0316-15 | | MIC | 1 | M type only |
| W02-0328-10 | | ENCODER ASS'Y | 1 | |
| W09-0323-05 | | LITHUM BATTERY CR2032 | 2 | |
| X41-1550-00 | N | SWITCH UNIT | 1 | |
| X44-1580-00 | N | RF UNIT | 1 | |
| X45-1350-00 | N | PA UNIT | 1 | |
| X48-1390-00 | N | IF UNIT | 1 | |
| X51-1320-00 | N | FILTER UNIT | 1 | |
| X53-1370-00 | N | CONT UNIT | 1 | |
| X54-1800-00 | N | DISP UNIT | 1 | |
| 2SA1015(Y) | | TR | 1 | |
| 25D29 | | DIODE | 1 | M type only |
| 490-0067-05 | | TAPE 3 MM | 4 | |
| SWITCH UNIT (X41-1550-00) | | | | |
| CK45F1H103Z | | CERAMIC 0.01 50V | 3 | C , 7, 8, 9 |
| CK45F1H473Z | | CERAMIC 0.047 50V | 4 | C , 3, 4, 5, 6 |
| C90-0817-05 | | FIXED ELECTRO | 2 | C , 1, 2 |
| E06-0858-05 | | CYLINDRICAL RECEPTACLE 8P | 1 | |
| E08-0272-05 | | VOLTAGE SELECTOR SOCKET 2P | 1 | |
| E08-0373-05 | | VOLTAGE SELECTOR SOCKET 3P | 1 | |
| E11-0401-05 | | EARPHONE JACK EXT.SP | 1 | |
| E11-0413-05 | | PHONE JACK PHONES | 1 | |
| E11-0418-05 | | PHONE JACK 3P KEY JACK | 1 | |
| E23-0401-05 | | TERMINAL (INSIDE) | 1 | |

| Parts No. | Re- marks | Description | Q'ty | Ref No. |
|-------------|--------------|----------------------|------|-------------------------|
| E40-0273-05 | | MINI CONNECTOR 2P | 5 | |
| E40-0373-05 | | MINI CONNECTOR 3P | 2 | |
| E40-0473-05 | | MINI CONNECTOR 4P | 1 | |
| E40-0673-05 | | MINI CONNECTOR 6P | 1 | |
| E40-0873-05 | | MINI CONNECTOR 8P | 1 | |
| E40-0973-05 | | PIN ASS'Y 9P | 1 | |
| L15-0016-05 | | LOW-FREQUENCY COIL | 1 | CM / 1 |
| R06-9407-05 | N | POTENTIOMETER 50 | 1 | VR / 1 |
| R12-1428-05 | N | TRIM.POT. RVF6P01 1K | 3 | VR / 5, 7, 10 |
| R12-3443-05 | N | TRIM.POT. 10K | 1 | VR / 9 |
| R12-4413-05 | N | TRIM.POT. 50K | 1 | VR / 6 |
| R12-1430-05 | N | TRIM.POT. 3K | 1 | VR / 8 |
| R19-3418-05 | N | POTENTIOMETER | 1 | VR / 3 |
| R19-3419-05 | N | POTENTIOMETER | 1 | VR / 2 |
| R19-3420-05 | N | POTENTIOMETER | 1 | VR / 4 |
| S40-2440-15 | | PUSH SW 2-2 | 7 | S / 3, 4, 5, 6, 7, 8, 9 |
| S40-2441-15 | | PUSH SW NON LDCX | 1 | S / 10 |
| S50-2402-05 | N | TACT SWITCH | 2 | S / 1, 2 |
| U05B | | DIODE | 1 | D / 1 |

RF UNIT (X44-1580-00)

| Parts No. | Re- marks | Description | Q'ty | Ref No. |
|--------------|--------------|------------------|------|--|
| BA282 | | DIODE | 5 | D / 3, 32, 34, 35, 36 |
| CC45UJ1H030C | | CERAMIC 3P 50V | 1 | C / 101 |
| CC45UJ1H120J | | CERAMIC 12P 50V | 1 | C / 96 |
| CC45SL1H0R5C | | CERAMIC 0.5P 50V | 1 | C / 7 |
| CC45SL1H121J | | CERAMIC 120P 50V | 1 | C / 136 |
| CC45CH1H040C | | CERAMIC 4P 50V | 2 | C / 6, 159 |
| CC45SL1H010C | | CERAMIC 1P 50V | 1 | C / 152 |
| CC45CH1H050C | | CERAMIC 5P 50V | 3 | C / 106, 113, 114 |
| CC45UJ1H150J | | CERAMIC 15P 50V | 2 | C / 99, 100 |
| CC45SL1H030C | | CERAMIC 3P 50V | 1 | C / 71 |
| CC45UJ1H180J | | CERAMIC 18P 50V | 5 | C / 84, 85, 86, 90, 102 |
| CC45CH1H090D | | CERAMIC 9P 50V | 2 | C / 105, 150 |
| CC45UJ1H220J | | CERAMIC 22P 50V | 1 | C / 102 |
| CC45SL1H331J | | CERAMIC 330P 50V | 1 | C / 75 |
| CC45SL1H470J | | CERAMIC 47P 50V | 2 | C / 51, 52 |
| CC45UJ1H270J | | CERAMIC 27P 50V | 2 | C / 83, 91 |
| CC45UJ1H300J | | CERAMIC 30P 50V | 1 | C / 89 |
| CC45RH1H120J | | CERAMIC 12P 50V | 2 | C / 37, 148 |
| CC45UJ1H330J | | CERAMIC 33P 50V | 1 | C / 94 |
| CC45RH1H150J | | CERAMIC 15P 50V | 1 | C / 175 |
| CC45SL1H101J | | CERAMIC 100P 50V | 2 | C / 139, 160 |
| CC45SL1H100D | | CERAMIC 10P 50V | 2 | C / 57, 65 |
| CC45SL1H151J | | CERAMIC 150P 50V | 2 | C / 109, 110 |
| CC45UJ1H100D | | CERAMIC 10P 50V | 1 | C / 95 |
| CC45SL1H221J | | CERAMIC 220P 50V | 1 | C / 111 |
| CC45SL1H220J | | CERAMIC 22P 50V | 1 | C / 38 |
| CC45RH1H180J | | CERAMIC 18P 50V | 2 | C / 176, 177 |
| CC45RH1H050C | | CERAMIC 5P 50V | 3 | C / 153, 173, 174 |
| CC45SL1H350J | | CERAMIC 33P 50V | 3 | C / 8, 117, 119 |
| CC45CH1H080D | | CERAMIC 8P 50V | 1 | C / 14 |
| CC45CH1H150J | | CERAMIC 15P 50V | 1 | C / 13 |
| CC45RH1H100D | | CERAMIC 10P 50V | 1 | C / 15 |
| CC45SL1H680J | | CERAMIC 68P 50V | 2 | C / 118, 166 |
| CC45SL1H820J | | CERAMIC 82P 50V | 1 | C / 145 |
| CC45CH1H220J | | CERAMIC 22P 50V | 1 | C / 149 |
| CC45CH1H240J | | CERAMIC 24P 50V | 1 | C / 151 |
| CE04W1A470M | | ELECTRO 47 10V | 4 | C / 88, 93, 98, 104 |
| CE04W1C100M | | ELECTRO 10 16V | 1 | C / 55 |
| CE04W1HR33M | | ELECTRO 0.33 50V | 1 | C / 169 |
| CE04W1H010M | | ELECTRO 1 50V | 1 | C / 79 |
| CE04W1H3R3M | | ELECTRO 3.3 50V | 1 | C / 170 |
| CK45F1H103Z | | CERAMIC 0.01 50V | 30 | C / 5, 12, 20, 27, 31, 41, 48, 53, 56, 63, 68, 76, 81, 112, 115, 121, 124, 125, 128, 130, 133, 146, 156, 157, 158, 162, 164, 168, 178, 179 |

| Parts No. | Re- marks | Description | Q'ty | Ref No. |
|-------------|--------------|---------------------------|------|--|
| CK45F1H223Z | | CERAMIC 0.022 50V | 15 | C / 19, 21, 22, 23, 29, 36, 45, 50, 73, 107, 123, 129, 138, 140 |
| CK45F1H223Z | | CERAMIC 0.022 50V | | C / 165 |
| CK45B1H471K | | CERAMIC 470P 50V | 2 | C / 120, 161 |
| CK45B1H102K | | CERAMIC 1000P 50V | 4 | C / 46, 67, 74, 134 |
| CK45F1H473Z | | CERAMIC 0.047 50V | 1 | C / 35 |
| C092M1H122K | | MYLAR 1200P 50V | 1 | C / 2 |
| C092M1H272K | | MYLAR 2700P 50V | 1 | C / 3 |
| C092M1H472K | | MYLAR 4700P 50V | 1 | C / 4 |
| C05-0030-15 | | TRIMMER 20PF | 1 | TC / 4 |
| C05-0309-05 | | TRIMMER 40P | 3 | TC / 1, 2, 3 |
| C90-0838-05 | | ELECTRO 1 50V | 1 | C / 60 |
| C91-0117-05 | | CERAMIC CAP 0.01 | 30 | C / 1, 10, 11, 16, 32, 34, 40, 44, 47, 54, 58, 59, 62, 66, 70, 78, 87, 92, 97, 103, 116, 122, 132, 135, 141, 142, 147, 155, 163, 171 |
| C91-0117-05 | | CERAMIC CAP 0.01 | | C / 30 |
| C91-1031-05 | N | FIXED 1200P 50V | 1 | C / 17, 18, 24, 25, 26, 28, 39 |
| C91-1008-05 | | CERAMIC 0.022 | 18 | C / 42, 43, 49, 69, 72, 77, 82 |
| C91-1008-05 | | CERAMIC 0.022 | | C / 108, 126, 127, 143 |
| C91-0119-05 | | CERAMIC 0.047 25V | 4 | C / 9, 33, 61, 80 |
| DTA114E(S) | N | DIGITAL TR | 6 | Q / 33, 35, 36, 37, 38, 44 |
| DTC114E(S) | | DIGITAL TR | 1 | Q / 43 |
| E23-0443-05 | | TERMINAL (INSIDE) TP | 5 | TP / 1, 2, 3, 4, 5 |
| E31-2170-05 | | JUMPER WIRE | 55 | |
| E40-0273-05 | | MINI CONNECTOR 2P | 11 | |
| E40-0373-05 | | MINI CONNECTOR 3P | 2 | |
| E40-0473-05 | | MINI CONNECTOR 4P | 1 | |
| E40-0573-05 | | MINI CONNECTOR 5P | 2 | |
| E40-0673-05 | | MINI CONNECTOR 6P | 1 | |
| ITT310TE | | VARI-CAP DIODE | 4 | D / 27, 29, 31, 33 |
| J31-0503-05 | | BEADS | 2 | |
| J31-0502-04 | | COLLAR | 8 | |
| J42-0428-05 | | BUSHING | 8 | |
| J61-0408-05 | | VINYL TIE | 1 | |
| L19-0324-05 | | TRANSFORMER | 2 | T / 20, 32 |
| L19-0328-05 | | TRANSFORMER | 1 | T / 36 |
| L19-0344-05 | | TRANSFORMER | 1 | T / 1 |
| L30-0506-05 | | I FT | 1 | T / 21 |
| L30-0511-05 | | I FT | 1 | T / 25 |
| L30-0512-05 | | I FT | 1 | T / 22 |
| L32-0193-05 | | OSCILLATING COIL 7MHZ | 1 | T / 31 |
| L32-0197-05 | | OSCILLATING COIL 21,28MHZ | 2 | T / 29, 30 |
| L32-0639-05 | | OSCILLATING COIL 50MHZ | 1 | T / 28 |
| L33-0222-05 | | CHOKE COIL | 2 | L / 39, 44 |
| L34-0535-05 | | TUNING COIL | 1 | T / 26 |
| L34-0536-05 | | TUNING COIL | 2 | T / 23, 27 |
| L34-0558-05 | | TRAP COIL | 1 | T / 3 |
| L34-0696-35 | | IN PUT COIL | 1 | T / 9 |
| L34-0697-05 | | OUTPUT COIL | 1 | T / 33 |
| L34-0908-05 | | TUNING COIL | 2 | L / 26, 27 |
| L34-0942-05 | | TUNING COIL | 1 | T / 24 |
| L34-0966-05 | | TRAP COIL | 2 | T / 2, 19 |
| L34-1021-05 | | INPUT COIL | 1 | L / 41 |
| L34-1022-05 | | OUTPUT COIL | 1 | L / 45 |
| L34-2054-05 | | TUNING COIL 52MHZ | 8 | T / 4, 5, 6, 7, 8, 38, 39, 40 |
| L34-2055-05 | | TUNING COIL 52MHZ | 2 | T / 41, 42 |
| L34-2205-05 | N | TUNING COIL 52MHZ | 1 | T / 37 |
| L34-2206-05 | N | TRAP COIL 8.83MHZ | 2 | T / 34, 35 |
| L34-3093-05 | N | BPF COIL 28MHZ | 2 | T / 10, 16 |
| L34-3094-05 | N | BPF COIL 28MHZ | 1 | T / 13 |
| L34-3095-05 | N | BPF COIL 21MHZ | 2 | T / 11, 17 |
| L34-3096-05 | N | BPF COIL 21MHZ | 1 | T / 12 |
| L34-3097-05 | N | BPF COIL 7MHZ | 1 | T / 12 |
| L34-3098-05 | N | BPF COIL 7MHZ | 1 | T / 18 |
| L34-3105-05 | N | BPF COIL 7MHZ | 1 | T / 18 |
| L40-1001-02 | | INDUCTOR 10 UH | 3 | L / 2, 3, 4 |
| L40-1011-03 | | INDUCTOR 100 UH | 1 | L / 18 |

PARTS LIST TS-670

| Parts No. | Re- marks | Description | Q'ty | Ref No. |
|---------------|--------------|--------------------------|------|--------------------------------|
| L40-1511-03 | | INDUCTOR 150 UH | 8 | L , 6, 9, 14, 16, 17, 32, 33 |
| L40-3391-13 | | INDUCTOR 3.3 UH | 1 | L , 34 |
| L40-4791-13 | | INDUCTOR 4.7 UH | 1 | L , 38 |
| L40-1001-13 | | INDUCTOR 10 UH | 1 | L , 43 |
| L40-4701-13 | | INDUCTOR 47 UH | 1 | L , 42 |
| L40-1011-17 | N | INDUCTOR 100 UH | 2 | L , 47 |
| L40-3982-14 | | INDUCTOR 0.39UH | 2 | L , 13, 29 |
| L40-8282-14 | | INDUCTOR 0.82UH | 2 | L , 21, 22 |
| L40-1092-14 | | INDUCTOR 1 UH | 1 | L , 20, 23 |
| L40-1592-14 | | INDUCTOR 1.5 UH | 1 | L , 40 |
| L40-4701-14 | | INDUCTOR 47 UH | 2 | L , 10 |
| L40-1011-14 | | INDUCTOR 100 UH | 15 | L , 15, 37 |
| L40-1011-14 | | INDUCTOR 100 UH | 1 | L , 1, 5, 7, 8, 11, 12, 19 |
| L40-2211-14 | | INDUCTOR 220 UH | 1 | L , 24, 28, 30, 31, 35, 36, 46 |
| L72-0324-05 | | CERAMIC FILTER 8.83MHZ | 1 | L , 48 |
| MC921 | | DOUBLE DIODE | 2 | L , 25 |
| MV13 | | VARISTOR | 2 | CF , 1 |
| MV203 | | VARISTOR | 1 | D , 40, 50 |
| R12-1429-05 | N | TRIM.POT. 500 | 2 | D , 22, 25 |
| R12-1430-05 | N | TRIM.POT. 3K | 2 | D , 48 |
| R12-7403-05 | | SEMI FIXED RGS6-FAM 500K | 1 | |
| R92-0150-05 | | JUMPER WIRE | 20 | |
| S51-1422-05 | N | RELAY | 2 | VR , 1, 2 |
| 1N60 | | DIODE | 3 | VR , 3, 4 |
| 1SS133 | | DIODE | 8 | VR , 5 |
| 1S1555 | | DIODE | 9 | RL , 1, 2 |
| 1S1587 | | DIODE | 16 | D , 21, 23, 24 |
| 1S1587 | | DIODE | 16 | D , 26, 37, 38, 41, 42, 43, 44 |
| 1S2588 | | DIODE | 7 | D , 46 |
| 2SA733(R) | | TR | 1 | D , 51, 52, 53, 54, 55, 56, 57 |
| 2SA562(Y) | N | TR | 4 | D , 58, 59 |
| 2SA1115(E) | | TR | 1 | D , 6, 8, 9, 11, 12, 13, 15 |
| 2SC2787(L) | N | TR | 3 | D , 16, 17, 18, 19, 20, 28, 30 |
| 2SC1923(O) | | TR | 1 | D , 45, 47 |
| 2SC2086 | | TR | 3 | D , 1, 2, 4, 5, 7, 10, 14 |
| 2SC2347 | | TR | 1 | Q , 32 |
| 2SC2458(Y) | | TR | 6 | Q , 39, 40, 41, 42 |
| 2SC460(B) | | TR | 3 | Q , 34 |
| 2SC1907 | N | TR | 3 | Q , 17, 18, 19 |
| 2SK192(Y) | | FET | 1 | Q , 23 |
| 2SK192A(GR)*N | | FET | 1 | Q , 28, 30, 31 |
| 3SK73(GR) | | FET | 3 | Q , 21 |
| 3SK74(L) | | FET | 2 | Q , 4, 8, 9, 10, 15, 16 |
| 3SK122(L) | | FET | 4 | Q , 12, 13, 14 |

FINAL UNIT (X45-1350-00)

| | | | | | |
|--------------|---------|-------|------|----|---------------------------|
| CC45SL1H220J | CERAMIC | 22P | 50V | 1 | C , 1 |
| CC45SL1H820J | CERAMIC | 82P | 50V | 1 | C , 6 |
| CC45SL2H220J | CERAMIC | 22P | 500V | 1 | C , 30 |
| CC45SL2H820J | CERAMIC | 82P | 500V | 1 | C , 11 |
| CC45SL2H221J | CERAMIC | 220P | 500V | 2 | C , 27, 28 |
| CC45SL2H331J | CERAMIC | 330P | 500V | 1 | C , 26 |
| CC45SL2H151J | CERAMIC | 150P | 500V | 1 | C , 29 |
| CE04W1C100M | ELECTRO | 10 | 16V | 2 | C , 16, 20 |
| CE04W1C221M | ELECTRO | 220 | 16V | 1 | C , 9 |
| CK45B1H102K | CERAMIC | 1000P | 50V | 4 | C , 12, 13, 14, 21 |
| CK45F1H103Z | CERAMIC | 0.01 | 50V | 12 | C , 2, 3, 4, 7, 8, 15, 17 |
| CK45F1H103Z | CERAMIC | 0.01 | 50V | 1 | C , 18, 19, 22, 24, 25 |
| CK45F1H223Z | CERAMIC | 0.022 | 50V | 2 | C , 5, 10 |
| C05-0043-05 | TRIMMER | 20P | | 1 | TC , 1 |

| Parts No. | Re- marks | Description | Q'ty | Ref No. |
|-------------|--------------|---------------------|------|-------------|
| E23-0401-05 | | TERMINAL (INSIDE) | 1 | |
| E23-0512-05 | | TERMINAL | 1 | |
| E31-2061-05 | | JUMPER WIRE | 2 | |
| F01-0761-03 | | HEAT SINK | 1 | |
| F20-0078-05 | | INSULATING PLATE | 1 | |
| J31-0505-04 | | COLLAR | 6 | |
| L19-0315-25 | | COIL | 1 | T , 1 |
| L19-0325-05 | | COIL | 1 | T , 2 |
| L19-0326-05 | | COIL | 1 | T , 3 |
| L19-0327-05 | | COIL | 1 | T , 4 |
| L33-0617-05 | | CHOKE COIL | 1 | L , 3 |
| L33-0025-05 | | CHOKE COIL 1.3UH | 3 | L , 1, 2, 4 |
| MV-5T | | DIODE | 1 | D , 1 |
| R12-0408-05 | | SEMI FIXED | 1 | VR , 2 |
| R12-1422-05 | | SEMI FIXED | 1 | VR , 1 |
| R92-0601-05 | | FIXED RESISTOR 0.22 | 1 | R , 9 |
| R92-0150-05 | | JUMPER WIRE | 3 | |
| SV03Y | | DIODE | 1 | D , 2 |
| 2SC1971 | | TR | 2 | Q , 1, 2 |
| 2SC2509 | | TR | 2 | Q , 3, 4 |
| 2SC496(Y) | | TR | 1 | Q , 5 |

IF UNIT (X48-1390-00)

| | | | | | |
|--------------|---------------|-------|------|----|--------------------------------|
| AN612 | IC | | | 1 | Q , 36 |
| AN7805 | IC | | | 1 | Q , 26 |
| AN7808 | IC | | | 1 | Q , 27 |
| CC45SL1H101J | CERAMIC | 100P | 50V | 3 | C , 44, 88, 89 |
| CC45J1H150J | CERAMIC | 15P | 50V | 1 | C , 35 |
| CC45SL1H221J | CERAMIC | 220P | 50V | 1 | C , 54 |
| CC45SL1H050C | CERAMIC | 5P | 50V | 1 | C , 12 |
| CC45SL1H100D | CERAMIC | 10P | 50V | 1 | C , 32 |
| CC45SL1H150L | CERAMIC | 15P | 50V | 2 | C , 4, 13 |
| CC45SL1H470L | CERAMIC | 47P | 50V | 5 | C , 53, 55, 107, 110, 121 |
| CE04W1C470M | ELECTRO | 47 | 16V | 1 | C , 75 |
| CE04W1HOR1M | ELECTRO | 0.1 | 50V | 1 | C , 50 |
| CE04W1HR22M | ELECTRO | 0.22 | 50V | 2 | C , 61, 81 |
| CE04W1HR47M | ELECTRO | 0.47 | 50V | 4 | C , 38, 46, 59, 140 |
| CE04W1H010M | ELECTRO | 1 | 50V | 13 | C , 44, 57, 72, 78, 80, 84, 86 |
| CE04W1A470M | ELECTRO | 47 | 10V | 8 | C , 92, 96, 98, 125, 126, 130 |
| CE04W1A221M | ELECTRO | 220 | 10V | 1 | C , 43, 48, 51, 70, 90, 97, 99 |
| CE04W1H477M | ELECTRO | 4.7 | 50V | 3 | C , 105 |
| CE04BW1HR22M | ELECTRO | 0.22 | 50V | 1 | C , 95 |
| CE04W1C100M | ELECTRO | 10 | 16V | 4 | C , 45, 58, 47 |
| CE04W1C220M | ELECTRO | 22 | 16V | 1 | C , 49 |
| CK45B1H471K | CERAMIC | 470P | 50V | 1 | C , 64, 82, 94, 113 |
| CK45B1H102K | CERAMIC | 1000P | 50V | 5 | C , 73 |
| CK45F1H223Z | CERAMIC | 0.022 | 50V | 4 | C , 111 |
| CQ45F1H103Z | CERAMIC | 0.01 | 50V | 2 | C , 14, 26, 34, 100, 108 |
| CQ92M1H222K | MYLAR | 2200P | 50V | 4 | C , 18, 19, 30, 123 |
| CQ92M1H822K | MYLAR | 8200P | 50V | 1 | C , 69, 127 |
| CQ92M1H103K | MYLAR | 0.01 | 50V | 3 | C , 41, 114, 135, 138 |
| CQ92M1H123K | MYLAR | 0.012 | 50V | 4 | C , 60 |
| CQ92M1H153K | MYLAR | 0.015 | 50V | 1 | C , 42, 136, 137 |
| CQ92M1H333K | MYLAR | 0.033 | 50V | 2 | C , 115, 116, 117, 118 |
| CQ92M1H473K | MYLAR | 0.047 | 50V | 3 | C , 91 |
| CQ92M1H104K | MYLAR | 0.1 | 50V | 1 | C , 37, 62 |
| CS15E1VR22M | TANTALUM | 0.22 | 35V | 1 | C , 65, 93, 139 |
| C05-0030-15 | TRIMMER | 20PF | | 1 | C , 67 |
| C90-0820-05 | ELECTRO | 470 | 16V | 1 | C , 31 |
| C90-0864-05 | FIXED ELECTRO | 220 | 10V | 1 | TC , 1 |
| C90-0866-05 | FIXED ELECTRO | 470 | 6.3V | 1 | C , 66 |
| C91-0769-05 | FIXED CAP | 0.01 | | 33 | C , 68 |

C , 1, 2, 3, 5, 6, 7, 8
9, 10, 11, 16, 17, 20, 29

| Parts No. | Re- marks | Description | Q'ty | Ref No. |
|-------------|--------------|--------------------------|------|-------------------------------------|
| C91-0769-05 | | FIXED CAP 0.01 | 1 | C / 33, 36, 39, 56, 74, 77, 79 |
| C91-0769-05 | | FIXED CAP 0.01 | 1 | C / 83, 87, 101, 102, 103, 106, 109 |
| C91-0117-05 | | FIXED CAP 0.01 | 4 | C / 112, 119, 122, 124, 128 |
| C91-0119-05 | | CERAMIC CAP 0.047 | 6 | C / 52, 71, 85, 132 |
| C91-1008-05 | | CERAMIC CAP 0.023 | 6 | C / 15, 28, 76, 104, 34, 0, 0 |
| | | | 1 | C / 0, 0, 0, 141 |
| | | | 1 | C / 133 |
| DTA114E(S) | N | DIGITAL TR | 1 | Q / 52 |
| DTC114E(S) | N | DIGITAL TR | 8 | Q / 2, 21, 24, 29, 30, 31, 37 |
| | | | 1 | Q / 38 |
| E29-0413-05 | | TERMINAL 1P | 1 | |
| E31-2170-05 | | JUMPER WIRE | 52 | |
| E40-0273-05 | | MINI CONNECTOR 2P | 21 | |
| E40-0373-05 | | MINI CONNECTOR 3P | 4 | |
| E40-0473-05 | | MINI CONNECTOR 4P | 4 | |
| E40-0573-05 | | MINI CONNECTOR 5P | 2 | |
| E40-0673-05 | | MINI CONNECTOR 6P | 1 | |
| E40-0773-05 | | PIN ASS'Y 7P | 1 | |
| F01-0784-03 | | HEAT SINK | 1 | |
| F20-0078-05 | | INSULATING PLATE | 1 | |
| F29-0014-05 | | INSULATING WASHER | 1 | |
| J31-0502-04 | | COLLAR | 7 | |
| J42-0428-05 | | BUSHING | 7 | |
| L34-0535-05 | | TUNING COIL | 1 | L / 10 |
| L34-0536-05 | | TUNING COIL | 1 | L / 4 |
| L34-0708-05 | | TUNING COIL | 1 | L / 1 |
| L34-2077-05 | | TUNING COIL | 1 | L / 2 |
| L40-1011-14 | | INDUCTOR 100 UH | 1 | L / 12 |
| L40-3391-13 | | INDUCTOR 3.3 UH | 1 | L / 8 |
| L40-1021-03 | | INDUCTOR 1 MH | 1 | L / 6 |
| L40-1011-17 | | INDUCTOR 100 UH | 2 | L / 9, 11 |
| L40-1511-14 | | INDUCTOR 150 UH | 3 | L / 5, 7, 14 |
| L40-4711-14 | | INDUCTOR 470 UH | 1 | L / 13 |
| L71-0245-05 | N | CRYSTAL FILTER YK-8B53 | 1 | XF / 1 |
| MC921 | N | DOUBLE DIODE | 7 | D / 66, 67, 68, 69, 70, 71, 72 |
| MI204 | | DIODE | 1 | D / 44 |
| MT24.3JA | | ZENER DIODE 4.3V | 1 | D / 73 |
| MT26.2JA | | ZENER DIODE 6.2V | 1 | D / 40 |
| MT29.1JB | | ZENER DIODE 9.1V | 1 | D / 60 |
| MT210JA | | ZENER DIODE 10V | 1 | D / 38 |
| MT212JB | | ZENER DIODE 12V | 1 | D / 63 |
| R12-1414-05 | | TRIM.POT. 1K OHM | 1 | VR / 1 |
| R12-2409-05 | | SEMI FIXED 5k | 1 | VR / 7 |
| R12-3430-05 | | TRIM.POT. 10K OHM | 3 | VR / 3, 5, 8 |
| R12-4408-05 | | SEMI FIXED 50k | 1 | VR / 10 |
| R12-7403-05 | | SEMI FIXED RGS6-FAN 500K | 1 | VR / 4 |
| R12-2413-05 | | TRIM.POT. 5k | 2 | VR / 2, 6 |
| R12-3443-05 | | TRIM.POT. 10K | 1 | VR / 9 |
| R92-0150-05 | | JUMPER WIRE | 18 | |
| UPC2002V | | IC | 1 | Q / 25 |
| V06B | | DIODE | 1 | D / 61 |
| 1N60 | | DIODE | 7 | D / 25, 26, 27, 28, 29, 33, 34 |
| 1S5133 | | DIODE | 8 | D / 11, 13, 19, 20, 35, 47, 48 |
| 1S1555 | | DIODE | 30 | D / 50 |
| 1S1555 | | DIODE | 1 | D / 1, 2, 12, 14, 16, 17, 18 |
| 1S1555 | | DIODE | 1 | D / 21, 22, 23, 24, 30, 31, 32 |
| 1S1555 | | DIODE | 1 | D / 36, 37, 39, 43, 49, 51, 52 |
| 1S1555 | | DIODE | 1 | D / 53, 54, 55, 56, 57, 58, 64 |
| 1S1555 | | DIODE | 1 | D / 65, 74 |
| 1S1555 | | DIODE | 8 | D / 2, 12, 14, 16, 17, 37, 52 |
| 1S1587 | | DIODE | 3 | D / 57 |
| 1S1007 | | DIODE | 6 | D / 9, 10, 46 |
| 1S2588 | | DIODE | 1 | D / 3, 4, 5, 6, 7, 8 |
| | | | 1 | D / 45 |

| Parts No. | Re- marks | Description | Q'ty | Ref No. |
|----------------------------------|--------------|-------------------------------|------|--------------------------------|
| 2SA1115(E) | | TR | 1 | Q / 23 |
| 2SA733(R) | | TR | 7 | Q / 9, 10, 11, 12, 13, 14, 18 |
| 2SC245B(Y) | | TR OR 2SC2603(E) | 16 | Q / 5, 15, 16, 20, 33, 39, 40 |
| | | | 1 | Q / 41, 43, 44, 45, 46, 47, 49 |
| 2SC245B(Y) | | TR OR 2SC2603(E) | 1 | Q / 50, 51 |
| 2SC2459(BL) | | TR | 5 | Q / 6, 7, 8, 34, 35 |
| 2SC2703(D,Y) | | TR | 2 | Q / 28, 48 |
| 2SD880(Y) | | TR | 1 | Q / 32 |
| 2SK192A(GR) | | FET | 1 | Q / 22 |
| 2SK30A(D) | | FET | 2 | Q / 17, 19 |
| 3SK73(GR) | | FET | 3 | Q / 1, 4, 42 |
| FILTER UNIT (X51-1320-00) | | | | |
| CC45SL2H330J | | CERAMIC 33P 500V | 1 | C / 16 |
| CC45SL2H470J | | CERAMIC 47P 500V | 1 | C / 14 |
| CC45SL2H560J | | CERAMIC 56P 500V | 5 | C / 22, 26, 33, 36, 38 |
| CC45SL2H020C | | CERAMIC 2P 500V | 1 | C / 46 |
| CC45SL2H101J | | CERAMIC 100P 500V | 3 | C / 7, 13, 17 |
| CC45SL2H121J | | CERAMIC 120P 500V | 1 | C / 5 |
| CC45SL2H151J | | CERAMIC 150P 500V | 3 | C / 9, 24, 44 |
| CC45SL2H1000 | | CERAMIC 10P 500V | 3 | C / 18, 32, 41 |
| CC45SL2H181J | | CERAMIC 180P 500V | 2 | C / 4, 8 |
| CC45SL2H221J | | CERAMIC 220P 500V | 2 | C / 15, 47 |
| CC45SL2H180J | | CERAMIC 18P 500V | 1 | C / 27 |
| CC45SL2H220J | | CERAMIC 22P 500V | 3 | C / 34, 37, 39 |
| CC45SL2H471J | | CERAMIC 470P 500V | 1 | C / 6 |
| CC45SL2H270J | | CERAMIC 27P 300V | 2 | C / 31, 40 |
| CE04W1HR47M | | ELECTRO 0.47 50V | 3 | C / 53, 55, 61 |
| CE04W1H010M | | ELECTRO 1 50V | 1 | C / 56 |
| CE04W1H3R3M | | ELECTRO 3.3 50V | 2 | C / 51, 57 |
| CE04W1C220M | | ELECTRO 22 16V | 1 | C / 49 |
| CK45B1H102K | | CERAMIC 1000P 50V | 5 | C / 48, 65, 66, 67, 68 |
| CK45F1H103Z | | CERAMIC 0.01 50V | 24 | C / 1, 2, 3, 10, 11, 12, 19 |
| | | | 1 | C / 20, 21, 28, 29, 30, 42, 43 |
| | | | 1 | C / 45, 50, 52, 54, 58, 59, 60 |
| | | | 1 | C / 62, 63, 64 |
| CK45F1H103Z | | CERAMIC 0.01 50V | 24 | C / 1, 2, 3, 10, 11, 12, 19 |
| C05-0043-05 | | TRIMMER 20P | 1 | TC / 1 |
| E04-0154-05 | | RF COAXIAL CABLE CONNECTOR RA | 2 | |
| E04-0157-05 | | RF COAXIAL CABLE RECEPTACLE | 1 | |
| E23-0430-05 | | TERMINAL (INSIDE) | 1 | |
| E40-0273-05 | | MINI CONNECTOR 2P | 3 | |
| E40-0673-05 | | MINI CONNECTOR 6P | 1 | |
| E40-0773-05 | | PIN ASS'Y 7P | 1 | |
| J31-0502-04 | | COLLAR | 7 | |
| J42-0428-05 | | BUSHING | 7 | |
| L34-3099-05 | N | LPF COIL 7MHZ | 2 | L / 5, 6 |
| L34-3100-05 | N | LPF COIL 21MHZ | 2 | L / 9, 10 |
| L34-3101-05 | N | LPF COIL 28MHZ | 2 | L / 13, 14 |
| L34-3102-05 | N | LPF COIL 50MHZ | 1 | L / 18 |
| L34-3103-05 | N | LPF COIL 50MHZ | 3 | L / 17, 19, 20 |
| L39-0410-15 | | COIL | 1 | T / 1 |
| L40-1011-13 | | INDUCTOR 100 UH | 4 | L / 1, 2, 24, 30 |
| L40-1011-14 | | INDUCTOR 100 UH | 14 | L / 3, 7, 11, 15, 21, 22, 23 |
| | | | 1 | L / 25, 26, 27, 28, 29, 32, 33 |
| M83614 | | IC | 1 | IC / 1 |
| MT26.2JB | | ZENER DIODE | 1 | D / 17 |
| R12-1418-05 | | SEMI FIXED | 2 | VR / 4, 5 |
| R12-3434-05 | | TRIM.POT. 10K(B)3 | 1 | VR / 3 |
| R12-4411-05 | | TRIM.POT. 50K | 2 | VR / 1, 2 |
| R92-0150-05 | | JUMPER WIRE | 24 | |
| S51-1420-05 | | RELAY DS-1 DC-12V | 10 | RL / 1, 2, 3, 4, 5, 6, 7 |
| | | | 1 | RL / 8, 9, 10 |
| 1N60 | | DIODE | 2 | D / 6, 7 |

PARTS LIST TS-670

| Parts No. | Re- marks | Description | Q'ty | Ref No. |
|------------|--------------|-------------|------|-------------------------|
| 1SS101 | | DIODE | 3 | D / 10, 15, 16 |
| 1S1555 | | DIODE | 12 | D / 1, 2, 3, 4, 5, 8, 9 |
| 1S1555 | | DIODE | 12 | D / 11, 12, 13, 14, 18 |
| 112-503-2 | | DIODE | 1 | TH / 14, 18 |
| 2SA562(Y) | | TR | 4 | Q / 1, 2, 3, 4 |
| 2SA1115(E) | | TR | 1 | Q / 5 |
| 2SC1815(Y) | | TR | 2 | Q / 6, 7 |

CONTROL UNIT (X53-1370-00)

| | | | | | | |
|--------------|--|-----------|-------|-----|----|---|
| CC45SL1H050C | | CERAMIC | 5P | 50V | 3 | C / 7, 74, 135 |
| CC45CH1H0R5C | | CERAMIC | 0.5P | 50V | 3 | C / 46, 98, 112 |
| CC45RH1H070D | | CERAMIC | 7P | 50V | 1 | C / 71 |
| CC45CH1H010C | | CERAMIC | 1P | 50V | 4 | C / 20, 27, 51, 56 |
| CC45RH1H120J | | CERAMIC | 12P | 50V | 1 | C / 132 |
| CC45SL1H100D | | CERAMIC | 10P | 50V | 5 | C / 6, 9, 75, 136, 223 |
| CC45CH1H020C | | CERAMIC | 2P | 50V | 3 | C / 12, 33, 41 |
| CC45RH1H150J | | CERAMIC | 15P | 50V | 3 | C / 25, 26, 34 |
| CC45RH1H180J | | CERAMIC | 18P | 50V | 1 | C / 172 |
| CC45SL1H150J | | CERAMIC | 15P | 50V | 1 | C / 15 |
| CC45RH1H220J | | CERAMIC | 22P | 50V | 5 | C / 45, 47, 96, 97, 131 |
| CC45UJ1H050C | | CERAMIC | 5P | 50V | 1 | C / 3 |
| CC45UJ1H100D | | CERAMIC | 10P | 50V | 1 | C / 5 |
| CC45RH1H270J | | CERAMIC | 27P | 50V | 2 | C / 168, 174 |
| CC45SL1H330J | | CERAMIC | 33P | 50V | 3 | C / 31, 101, 103 |
| CC45RH1H330J | | CERAMIC | 33P | 50V | 2 | C / 50, 52 |
| CC45CH1H150J | | CERAMIC | 15P | 50V | 2 | C / 113, 218 |
| CC45CH1H180J | | CERAMIC | 18P | 50V | 1 | C / 217 |
| CC45RH1H390J | | CERAMIC | 39P | 50V | 2 | C / 169, 173 |
| CC45SL1H470J | | CERAMIC | 47P | 50V | 2 | C / 87, 89 |
| CC45SL1H560J | | CERAMIC | 56P | 50V | 1 | C / 102 |
| CC45RH1H470J | | CERAMIC | 47P | 50V | 2 | C / 170, 171 |
| CC45RH1H560J | | CERAMIC | 56P | 50V | 2 | C / 110, 111 |
| CC45SL1H101J | | CERAMIC | 100P | 50V | 3 | C / 24, 88, 175 |
| CC45RH1H030C | | CERAMIC | 3P | 50V | 1 | C / 84, 133 |
| CC45SL1H151J | | CERAMIC | 150P | 50V | 6 | C / 4, 17, 81, 83, 141, 143 |
| CC45RH1H050C | | CERAMIC | 5P | 50V | 2 | C / 73, 84 |
| CC45TH1H100D | | CERAMIC | 10P | 50V | 1 | C / 130 |
| CC45TH1H120J | | CERAMIC | 12P | 50V | 1 | C / 70 |
| CC45TH1H390J | | CERAMIC | 39P | 50V | 1 | C / 129 |
| CE04W1C100M | | ELECTRO | 10 | 16V | 1 | C / 199 |
| CE04W1A470M | | ELECTRO | 47 | 10V | 7 | C / 189, 194, 195, 196, 213, 215, 216 |
| CE04W1A101M | | ELECTRO | 100 | 10V | 5 | C / 1, 68, 125, 185, 192 |
| CE04W1HR47M | | ELECTRO | 0.47 | 50V | 1 | C / 120 |
| CE04W1H010M | | ELECTRO | 1 | 50V | 2 | C / 118, 214 |
| CE04W1H2R2M | | ELECTRO | 2.2 | 50V | 1 | C / 190 |
| CE04W1H4R7M | | ELECTRO | 4.7 | 50V | 1 | C / 203 |
| CK45B1H331K | | CERAMIC | 330P | 50V | 2 | C / 82, 142 |
| CK45B1H102K | | CERAMIC | 1000P | 50V | 8 | C / 114, 115, 119, 151, 164, 179, 197, 198 |
| CK45B1H222K | | CERAMIC | 2200P | 50V | 3 | C / 69, 126, 187 |
| CK45F1H103Z | | CERAMIC | 0.01 | 50V | 30 | C / 29, 36, 60, 61, 63, 76, 77, 80, 85, 86, 90, 95, 99, 100, 104, 109, 116, 121, 134, 137, 140, 144, 149, 155, 166, 167, 176, 205, 212, 219 |
| CK45F1H103Z | | CERAMIC | 0.01 | 50V | 1 | C / 66 |
| CQ92M1H103K | | MYLAR | 0.01 | 50V | 1 | C / 123 |
| CQ92M1H473K | | MYLAR | 0.047 | 50V | 1 | C / 182 |
| CQ92M1H104K | | MYLAR | 0.1 | 50V | 1 | C / 122 |
| CQ92M1H102K | | MYLAR | 1000P | 50V | 1 | C / 65, 181 |
| CQ92M1H152K | | MYLAR | 1500P | 50V | 2 | C / 1 |
| CO5-0309-05 | | TRIMMER | 40P | | 1 | TC / 1 |
| CO5-0030-15 | | TRIMMER | 20PF | | 1 | TC / 2 |
| C90-0838-05 | | ELECTRO | 1 | 50V | 1 | C / 202 |
| C91-0119-05 | | CERAMIC | 0.047 | 25V | 35 | C / 2, 16, 21, 22, 28, 32, 64, 67, 72, 79, 91, 92, 93, 94, 117, 124, 127, 128, 139, 145, 146, 147, 148, 152, 160, 177, 180, 183, 184, 186, 188, 191, 193, 204, 211, 39, 201 |
| C91-0119-05 | | CERAMIC | 0.047 | 25V | 1 | C / 201 |
| C91-0119-05 | | CERAMIC | 0.047 | 25V | 1 | C / 201 |
| C91-0498-05 | | FIXED CAP | 0.35P | | 1 | C / 39 |
| C91-0457-05 | | FIXED CAP | 0.022 | | 1 | C / 201 |

| Parts No. | Re- marks | Description | Q'ty | Ref No. |
|-------------|--------------|--------------------------|------|---|
| C91-0769-05 | | FIXED CAP 0.01 | 38 | C / 8, 10, 14, 23, 30, 35, 37, 43, 44, 48, 49, 53, 54, 58 |
| C91-0769-05 | | FIXED CAPACITOR 0.01UF | C | / 59, 62, 78, 105, 106, 107, 108, 138, 153, 156, 157, 158, 159, 161, 162, 163, 165, 178, 200, 206, 207, 208, 209, 210 |
| C91-0769-05 | | FIXED CAPACITOR 0.01UF | C | / 162, 163, 165, 178, 200, 206, 207, 208, 209, 210 |
| E23-0443-05 | | TERMINAL (INSIDE) TP | 3 | |
| E31-2170-05 | | JUMPER WIRE | 81 | |
| E40-5023-05 | N | LP CONNECTOR 2P | 3 | |
| E40-5024-05 | N | LP CONNECTOR 3P | 1 | |
| E40-5025-05 | N | LP CONNECTOR 5P | 2 | |
| E40-5026-05 | N | LP CONNECTOR 6P | 1 | |
| E40-0273-05 | | MINI CONNECTOR 2P | 14 | |
| E40-0373-05 | | MINI CONNECTOR 3P | 5 | |
| E40-0473-05 | | MINI CONNECTOR 4P | 3 | |
| E40-0673-05 | | MINI CONNECTOR 6P | 1 | |
| E40-0773-05 | | PIN ASS'Y 7P | 2 | |
| ITT310TE | | VARI-CAP DIODE | 1 | D / 21 |
| J31-0502-04 | | COLLAR | 8 | |
| J42-0428-05 | | BUSHING | 8 | |
| J61-0408-05 | | VINYL TIE | 3 | |
| L32-0666-05 | N | OSCILLATING COIL | 2 | L / 6, 20 |
| L34-2207-05 | N | TUNING COIL 48MHZ | 1 | T / 1 |
| L34-2208-05 | N | TUNING COIL 24MHZ | 4 | T / 2, 5, 6, 7 |
| L34-2209-05 | N | TUNING COIL 6MHZ | 2 | T / 3, 4 |
| L34-2211-05 | N | TUNING COIL 56MHZ | 3 | T / 8, 9, 10 |
| L34-2212-05 | N | TUNING COIL 14MHZ | 2 | T / 15, 16 |
| L34-2213-05 | N | TUNING COIL 2.8MHZ | 2 | T / 17, 18 |
| L34-2214-05 | N | TUNING COIL 8.4MHZ | 2 | T / 21, 22 |
| L34-0781-05 | | TUNING COIL 9MHZ | 2 | T / 19, 20 |
| L34-3064-05 | | TUNING COIL | 4 | T / 11, 12, 13, 14 |
| L34-3104-05 | N | LPF COIL | 2 | T / 23, 24 |
| L40-2201-13 | | INDUCTOR 22 UH | 1 | L / 32 |
| L40-1801-03 | | INDUCTOR 18 UH | 2 | L / 24, 25 |
| L40-1011-13 | | INDUCTOR 100 UH | 7 | L / 33, 34, 36, 37, 38, 39, 40 |
| L40-2201-03 | | INDUCTOR 22 UH | 2 | L / 12, 13 |
| L40-8201-03 | | INDUCTOR 82 MH | 2 | L / 10, 11 |
| L40-1001-14 | | INDUCTOR 10 UH | 1 | L / 41 |
| L40-1011-03 | | INDUCTOR 100 UH | 2 | L / 4, 18 |
| L40-2711-03 | | INDUCTOR 270 UH | 2 | L / 21, 22 |
| L40-3311-03 | | INDUCTOR 330 UH | 2 | L / 8, 9 |
| L40-4711-03 | | INDUCTOR 470 UH | 2 | L / 5, 17 |
| L40-1011-14 | | INDUCTOR 100 UH | 7 | L / 1, 2, 15, 16, 23, 29, 31 |
| L40-1511-14 | | INDUCTOR 150 UH | 3 | L / 14, 26, 27 |
| L40-2211-14 | | INDUCTOR 220 UH | 6 | L / 3, 7, 19, 28, 30, 35 |
| L72-0343-05 | N | CERAMIC FILTER 8.4MHZ | 1 | CF / 1 |
| L77-1226-05 | N | CRYSTAL 24MHZ | 1 | X / 1 |
| L77-1257-05 | N | CRYSTAL 8.1MHZ | 1 | X / 2 |
| MB4052 | N | IC | 1 | IC / 15 |
| MC14077B | | IC | 1 | IC / 24 |
| MC911 | | DIODE | 1 | D / 56 |
| MN6147C | | IC | 3 | IC / 3, 4, 13 |
| MTZ7.5JC | | DIODE | 1 | D / 25 |
| M54459L | | IC | 2 | IC / 5, 9 |
| R12-4411-05 | | TRIM.POT. 50K | 1 | VR / 1 |
| R90-0511-05 | | RESISTOR BLOCK | 2 | RB / 1, 2 |
| R90-0515-05 | | RESISTOR BLOCK 10K X 4 | 1 | RB / 4 |
| R90-0534-05 | | RESISTOR BLOCK 10K X 5 | 1 | RB / 7 |
| R90-0561-05 | | RESISTOR BLOCK 22K X 6 | 1 | RB / 5 |
| R90-0574-05 | N | RESISTOR BLOCK 4.7K X 11 | 1 | RB / 3 |
| R90-0575-05 | N | RESISTOR BLOCK 10K X 3 | 1 | RB / 6 |
| R92-0150-05 | | JUMPER WIRE | 20 | |
| SN16913P | | IC | 5 | IC / 7, 8, 10, 11, 12 |
| SN74LS75N | | IC | 1 | IC / 21 |
| SN74LS93N | | IC | 1 | IC / 2 |
| SN74LS112AN | | IC | 2 | IC / 1, 6 |
| SN74LS145N | | IC | 1 | IC / 22 |

| Parts No. | Re- marks | Description | Q'ty | Ref No. |
|---------------|--------------|-----------------|------|---|
| S31-0401-05 | N | DIP SWITCH 10P | 1 | |
| TAS7 | N | TRANSISTOR AREY | 1 | Q / 55 |
| TC4011BP | | IC | 3 | IC / 14, 25, 26 |
| TC4071BP | N | IC | 2 | IC / 23, 27 |
| TMP8049P-3034 | N | IC | 1 | IC / 19 |
| UPD8049HC-092 | N | IC | 1 | IC / 16 |
| UPD8243C | | IC | 2 | IC / 17, 20 |
| UPD444C-0 | | IC | 1 | IC / 18 |
| 1N60 | | DIODE | 1 | D / 38 |
| 1S133 | | DIODE | 6 | D / 26, 27, 28, 29, 39, 40 |
| 1SV53A | | DIODE | 1 | D / 20 |
| 1S1555 | | DIODE | 48 | D / 5, 6, 7, 8, 22, 23, 24 / 30, 31, 32, 33, 34, 35, 36 / 47, 48, 49, 50, 51, 52, 53 |
| 1S1555 | | DIODE | | D / 54, 55, 58, 59, 60, 61, 62 / 63, 64, 65, 66, 67, 68, 69 |
| 1S1555 | | DIODE | | D / 70, 71, 72, 73, 74, 75 |
| 1S1587 | | DIODE | 12 | D / 2, 3, 4, 9, 10, 12, 13 / 14, 16, 17, 18, 19 |
| 1S2588 | | DIODE | 3 | D / 1, 11, 15 |
| 2SA1015(Y) | | TR | 7 | Q / 35, 43, 50, 51, 52, 53, 54 |
| 2SC1923(O) | | TR | 4 | Q / 9, 13, 14, 24 |
| 2SC1775(E) | | TR | 9 | Q / 10, 11, 12, 21, 22, 23, 32 / 33, 34 |
| 2SC460(B) | | TR | 3 | Q / 1, 16, 17 |
| 2SC1959(Y) | | TR | 1 | Q / 19 |
| 2SC1815(Y) | | TR | 30 | Q / 2, 3, 4, 5, 6, 7, 8 / 15, 18, 20, 25, 26, 27, 28 / 29, 30, 31, 36, 37, 38, 39 / 40, 41, 42, 44, 45, 46, 47 |
| 2SC1815(Y) | | TR | | Q / 48, 49 |

| Parts No. | Re- marks | Description | Q'ty | Ref No. |
|-----------------------------------|--------------|--------------------------|------|----------------|
| DISPLAY UNIT (X54-1800-00) | | | | |
| CE04W1A470M | | ELECTRO 47 10V | 1 | C / 1 |
| CE04W1C101M | | ELECTRO 100 16V | 1 | C / 2 |
| CE04W1V100M | | ELECTRO 10 35V | 3 | C / 3, 5, 6 |
| CQ92M1H103K | | MYLAR 0.01 50V | 1 | C / 4 |
| C90-0840-05 | | ELECTRIC BLOCK CAPACITOR | 1 | C / 7 |
| C91-0119-05 | | CERAMIC CAP 0.047 | 2 | C / 8, 9 |
| E31-3024-05 | N | TAPE CABLE 2 WIRE | 1 | |
| E31-3025-05 | N | TAPE CABLE 10 WIRE | 2 | |
| E40-0273-05 | | MINI CONNECTOR 2P | 1 | |
| E40-0373-05 | | MINI CONNECTOR 3P | 1 | |
| E40-0773-05 | | PIN ASS'Y 7P | 1 | |
| E40-3008-05 | | PIN CONNECTOR 3P | 1 | |
| FIP11FM7 | N | DISPLY TUBE | 1 | |
| J21-4133-04 | N | HARDWARE FIXTURE | 1 | |
| L19-0323-05 | | TRANSFORMER | 1 | T / 1 |
| L40-1011-14 | | INDUCTOR 100 UH | 1 | L / 2 |
| L40-1011-13 | | INDUCTOR 100 UH | 1 | L / 1 |
| MT28.2JB | | ZENER DIODE 8.2V | 1 | D / 5 |
| MTZ6.2JA | | ZENER DIODE 6.2V | 1 | D / 6 |
| R92-0150-05 | | JUMPER WIRE | 17 | |
| UPA80C | N | IC | 3 | IC / 1, 2, 3 |
| UPD8243C | | IC | 1 | IC / 4 |
| 1S1555 | | DIODE | 4 | D / 1, 2, 3, 4 |
| 2SC1959(Y) | | TR | 2 | Q / 1, 2 |

TS-670 PC BOARD VIEW

SWITCH UNIT (X41-1550-00) Component side view

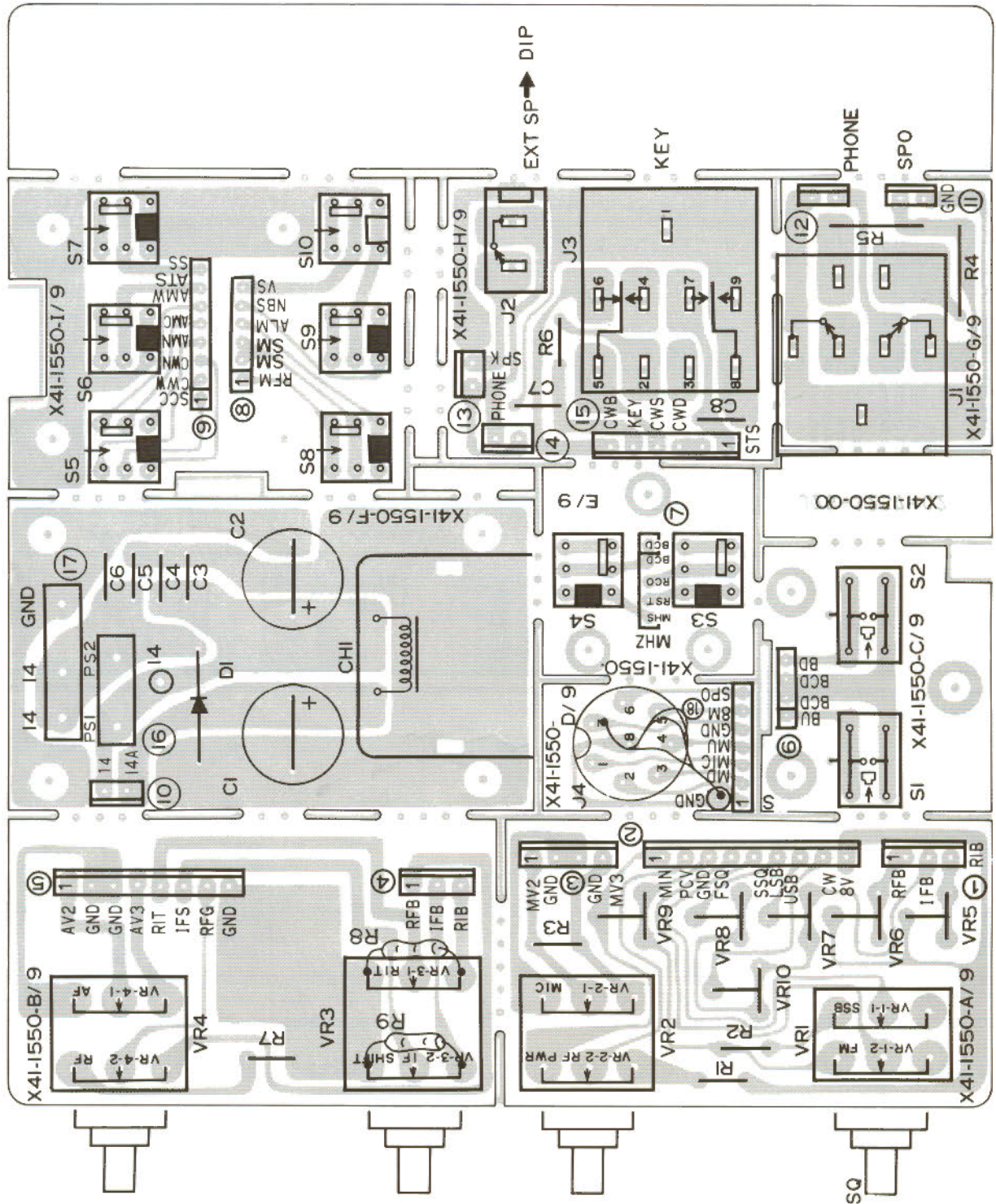

Terminal number



PC BOARD VIEW

RF UNIT (X44-1580-00)

Component side view

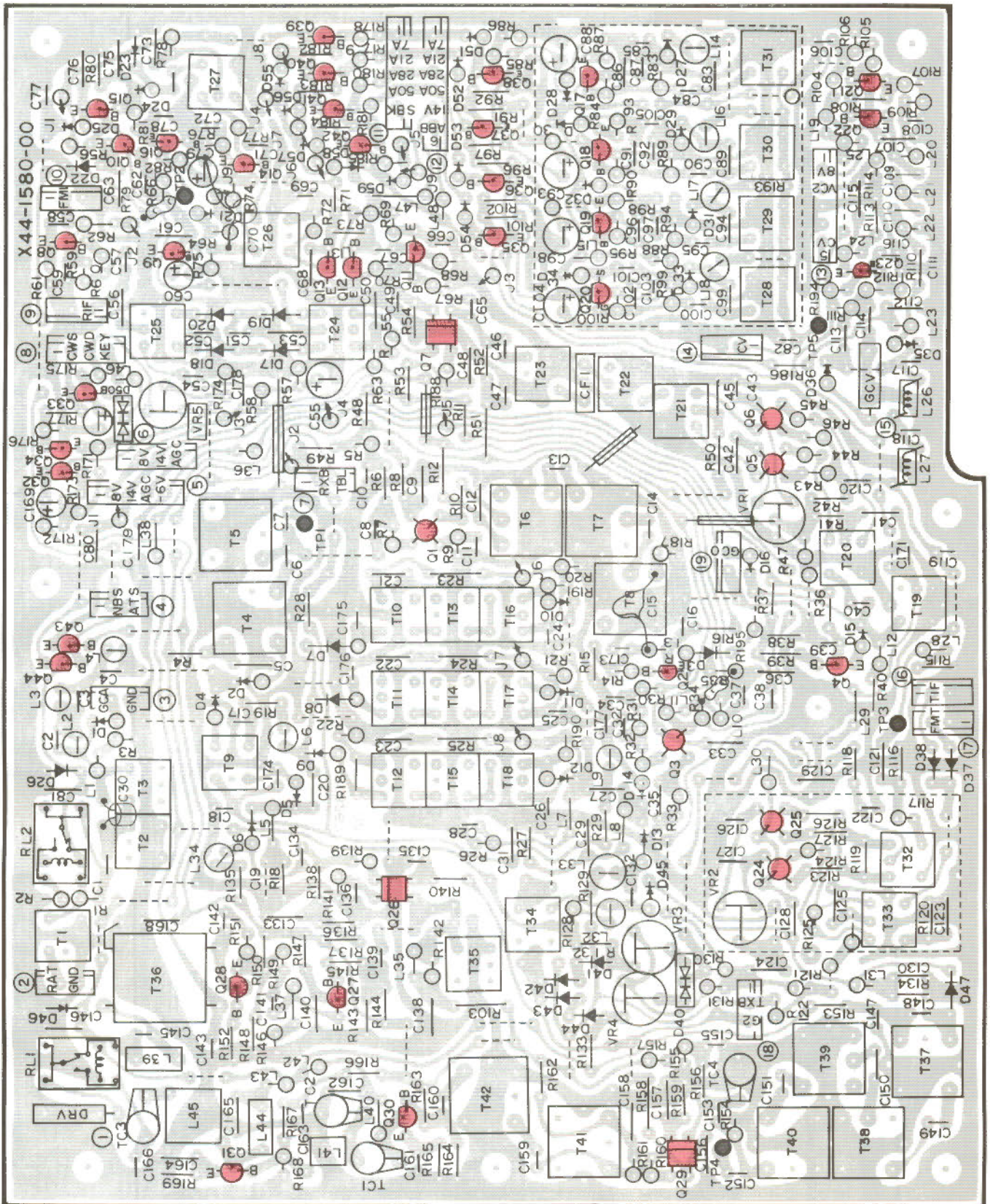

PC BOARD VIEW

IF UNIT (X48-1390-00) Component side view

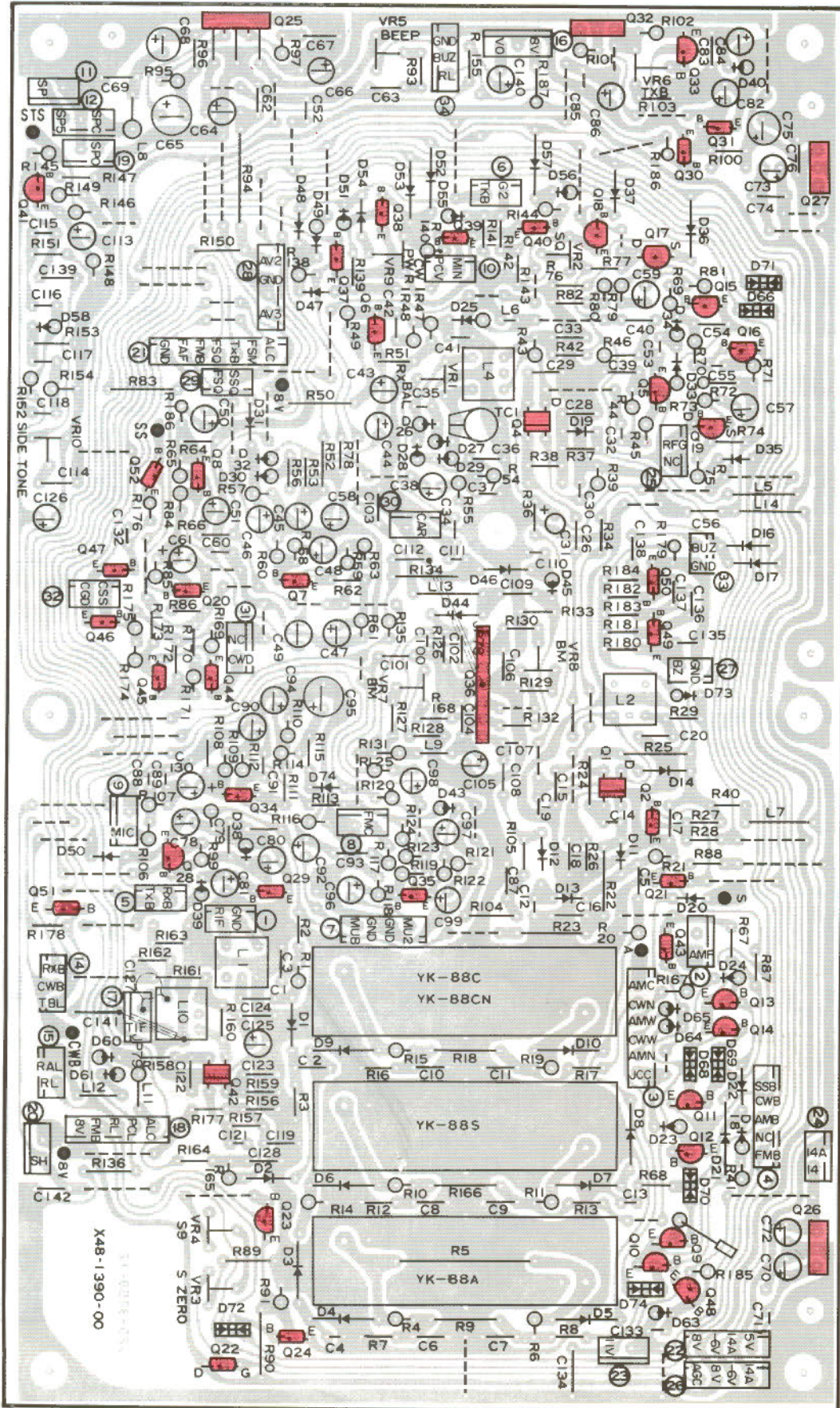

PC BOARD VIEW

CONTROL UNIT (X53-1370-00) Component side view

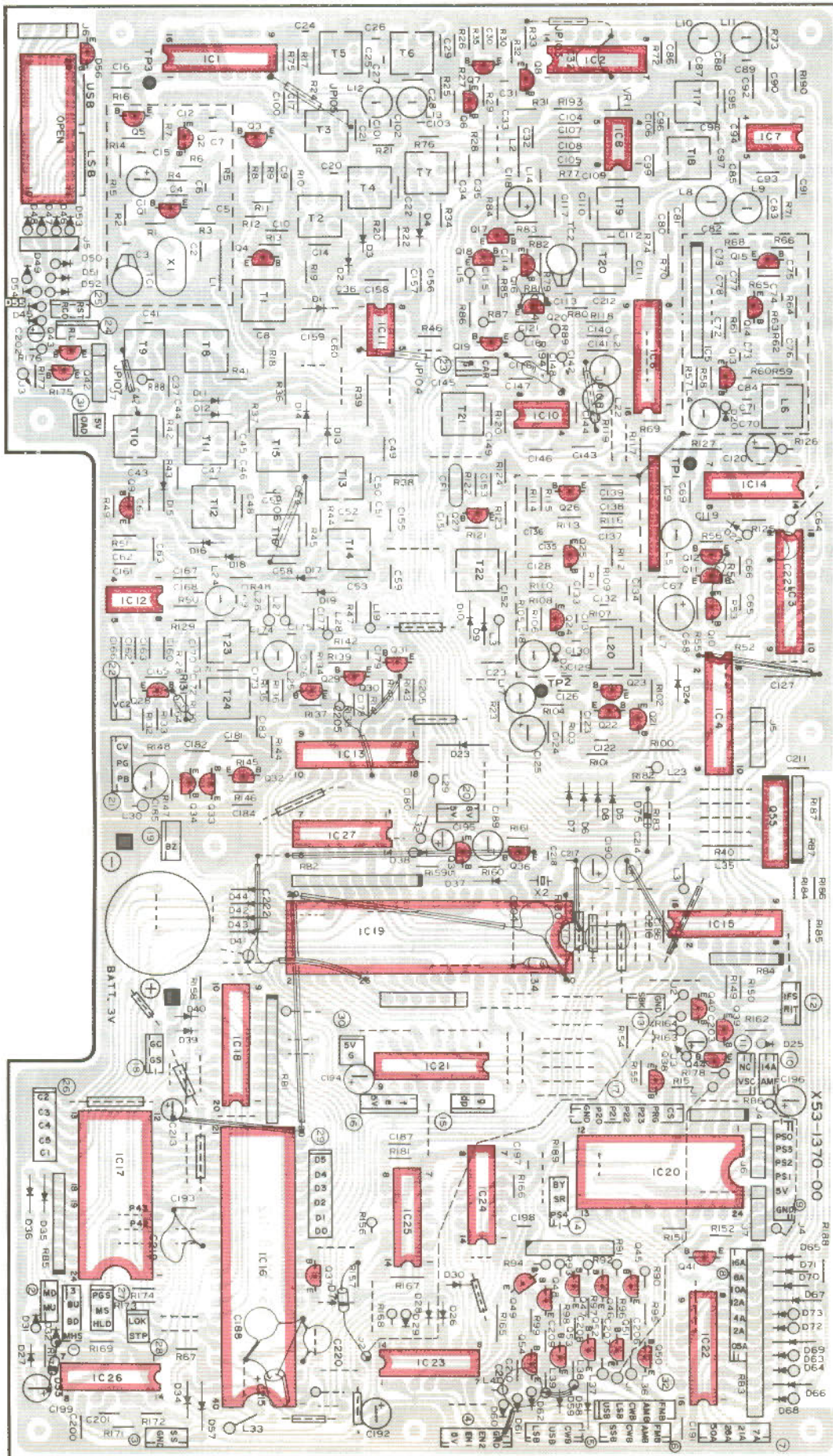

M54459L



SN16913P



2SC460

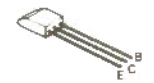

2SA1015

2SC1815

2SC1923

2SC1775



TS-670 PC BOARD VIEW

FINAL UNIT (X45-1350-00) Component side view

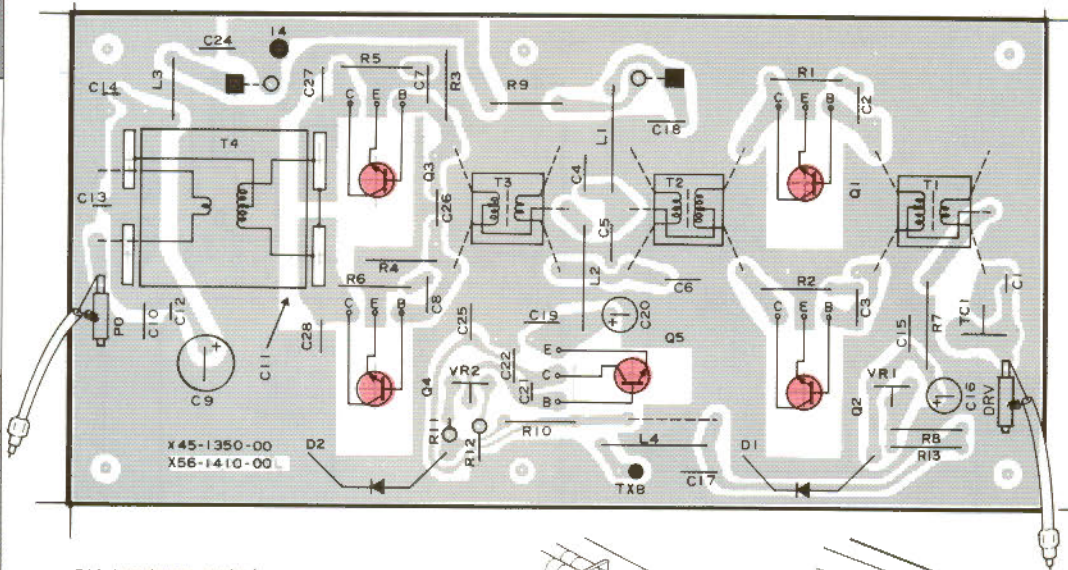

C11 Attachment method



- 1 Cut wire short as possible on C11
- 2 Bend C11 as shown left after solder confirm not over edge.

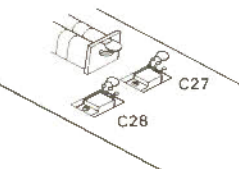

C27 and C28 should be installed as shown above. Do not install them as indicated in the PC board with silk printed pattern.

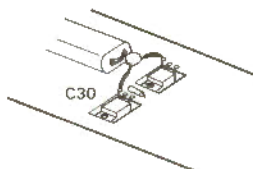

C30 should be installed externally and directly as shown above
(Cover the C30 leads with flux tubes (212-1019-05); the leads length should be minimum.)

2SC1971
2SC2509

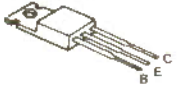

2SC496



2SA562
2SA1115
2SC1815

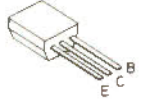

FILTER UNIT (X51-1320-00) Component side view

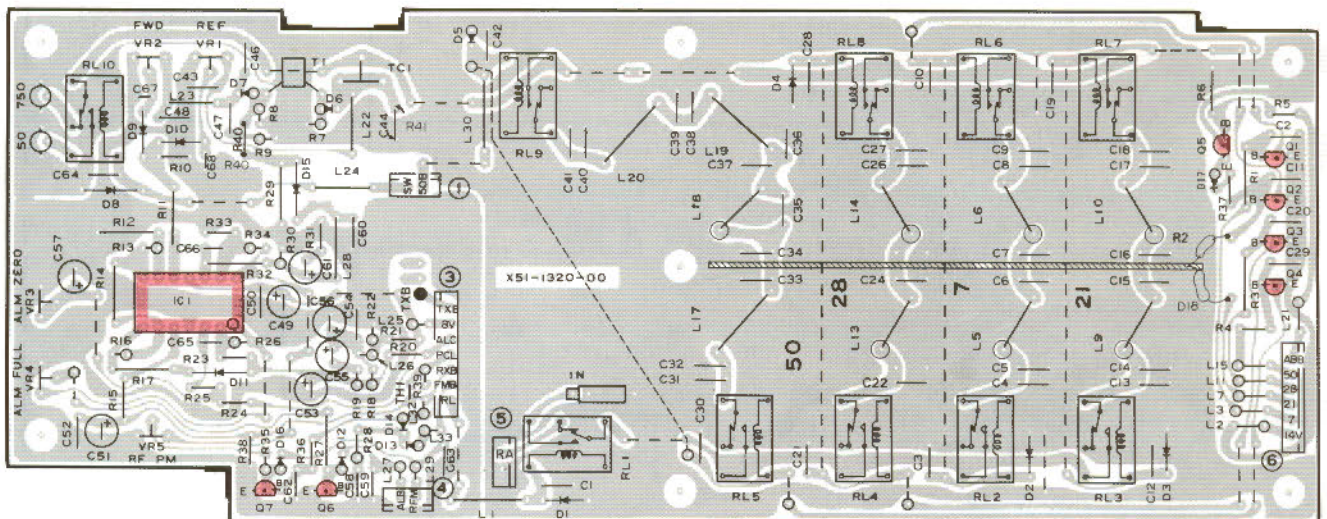

Q1-4: 2SA562(Y) Q5: 2SA1115(E) Q6, 7: 2SC1815(Y) IC1: MB3614 CRLM324 D1-5, 8, 11-14: 1S1555 D6, 7: 1N60 D9, 10, 15, 16: 1SS101 D17: MTZ3.9JA

Attachment method of L5, 6, 9, 10, 13, 14, 18.



Attachment method of JP24 as shown following.

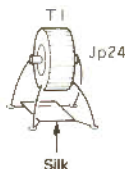

MB3614
LM324



3SK73(GR)



DISPLAY UNIT (X54-1800-00) Component side view

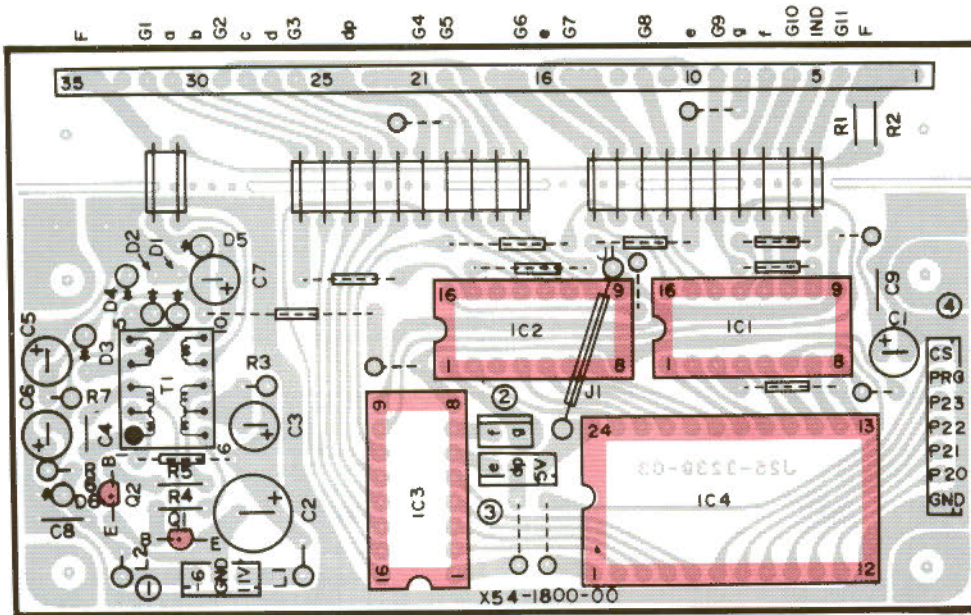

DISPLAY TUBE
FIP11FM7

| Place | Character |
|-------|-----------|
| G 1 | RIT |
| G 2 | |
| G 3 | |
| G 4 | AL |
| G 5 | |
| G 6 | SPLIT |
| G 7 | B |
| G 8 | VFO |
| G 9 | A |
| G10 | T |
| G11 | M.CH |

IC4 (μ PD8243C)

| Terminal No. | Terminal name |
|--------------|---------------|
| 24 | Vcc |
| 2 | P40 |
| 3 | P41 |
| 4 | P42 |
| 5 | P43 |
| 6 | CS |
| 7 | PROG |
| 8 | P23 |
| 9 | P22 |
| 10 | P21 |
| 11 | P20 |
| 12 | GND |
| 13 | P70 |
| 14 | P71 |
| 15 | P72 |
| 16 | P73 |
| 17 | P63 |
| 18 | P62 |
| 19 | P61 |
| 20 | P60 |
| 21 | P53 |
| 22 | P52 |
| 23 | P51 |
| 1 | P50 |

ENCODER UNIT (W02-0328-10) Component side view

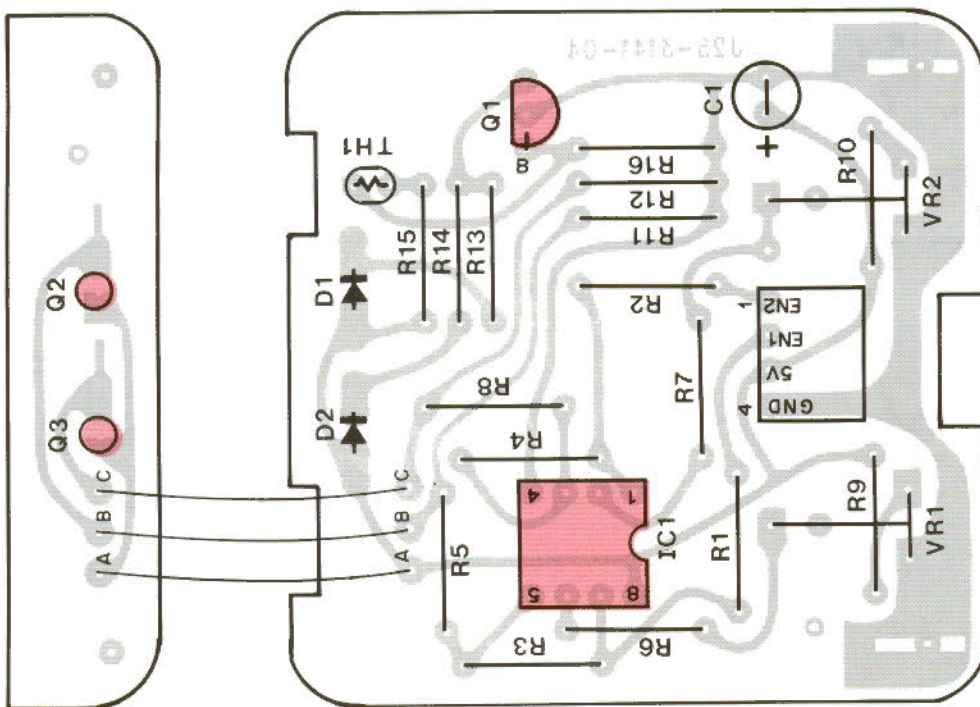

TS-670

ADJUSTMENT

REQUIRED TEST EQUIPMENT

1. DC Voltmeter

- 1) Input resistance: More than 1 M Ω
- 2) Voltage range: 1.5 to 1000 V AC/DC

NOTE: A high-precision multimeter may be used. However, accurate readings can not be obtained for high-impedance circuits.

2. DC Ammeter

- 1) Current range: 150 mA, 500 mA, 2 A, 10 A, High-precision ammeter may be used.

3. RF VTVM

- 1) Input impedance: 1 M Ω and less than 3 pF, min.
- 2) Voltage range: 10 mV to 300 V
- 3) Frequency range: 10 kHz ~ 100 MHz or greater

4. AF Voltmeter

- 1) Frequency range: 50 Hz to 10 kHz
- 2) Input resistance: 1 M Ω or greater
- 3) Voltage range: 10 mV to 30 V

5. AF Generator (AG)

- 1) Frequency range: 200 Hz to 5 kHz
- 2) Output: 1 mV or less ~ 1 V, low distortion

6. AF Dummy Load

- 1) Impedance: 8 Ω
- 2) Dissipation: 3 W or greater

7. Oscilloscope

Requires high sensitivity, and external synchronization capability.

8. Sweep Generator

- 1) Center frequency: 5 MHz ~ 60 MHz
- 2) Frequency deviation: Maximum ± 16 MHz
- 3) Output voltage: 0.1 V or greater
- 4) Sweep rate: At least 0.5 sec/cm

9. Standard Signal Generator (SSG)

- 1) Frequency range: 8 to 60 MHz
- 2) Output: -20 dB/0.1 μ V ~ 120 dB/1 V
- 3) Output impedance: 50 Ω
- 4) AM and FM modulation can be possible.

NOTE: Generator must be frequency stable.

10. Frequency Counter

- 1) Minimum input voltage: 50 mV
- 2) Frequency range: 60 MHz or greater

11. Noise Generator

Must generate ignition noise containing harmonics beyond 60 MHz.

12. Power Meter

- 1) Impedance: 50 Ω
- 2) Dissipation: 15 W continuous or greater
- 3) Frequency limits: 60 MHz or greater

13. Spectrum Analyzer

- 1) Frequency range: 100 K to 110 MHz or greater
- 2) Bandwidth: 1 kHz to 3 MHz

14. Detector

- 1) For adjustment of TX BPF

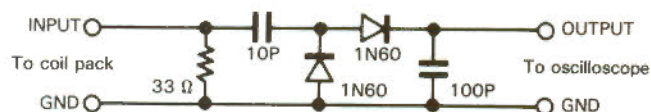

- 2) For adjustment of PLL BPF

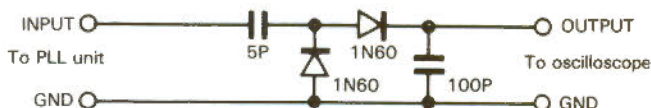

15. Directional Coupler

16. Power supply

13.8 V DC. Min 4 A

PREPARATION

Unless otherwise specified, set the controls as follows.

| | | | |
|----------------|------|----------------|-----|
| POWER | ON | STEP | OFF |
| NB | OFF | MIC | MIN |
| SEND/REC | REC | RF PWR | MAX |
| ATT | OFF | SQUELCH | MIN |
| NAR/WIDE | WIDE | RIT | CEN |
| VFO/M | VFO | IF SHIFT | CEN |
| MODE | VSB | AF | MIN |
| FUNCTION | A | RF | MAX |
| SPLIT | OFF | BAND | 50 |
| LOCK | OFF | RIT | OFF |

ADJUSTMENT

VOLTAGE ADJUSTMENT

| Item | Condition | Measurement | | | Adjustment | | | Specification | Remarks |
|-------------------------------------|---|----------------|------|--------------|-------------|----------------|-------------|------------------------------|---------|
| | | Test equipment | Unit | Terminal | Unit | Parts | Method | | |
| Voltage adjustment and confirmation | POWER SW: ON MODE: SSB SEND SW: REC | DC VM | IF | | | | | | |
| | (1) 8V | | | 22 -1 | | | | 8.55 - 9.45V | |
| | (2) -6V | | | 22 -2 | | | | -5.9 - -6.1V | |
| | (3) 14V | | | 22 -3 | | | | 13.5V ± 0.3V | |
| | 5V | | | 22 -4 | | | | 4.75 - 5.25V | |
| | (4) RFG | | | 25 -1 | SWITCH | VR6 | | 2.6V ± 0.05_V ₀ | |
| | (5) RXB | | | 23 -2 | | | | 11.0V ± 0.3V | |
| | | | | 5 -2 | | | | 8.0V - 9.0V | |
| | (6) RXB | | | 5 -2 | | | SEND SW: ON | 0V ON AIR (IND) lights | |
| | | | | | | | SEND SW: ON | 13.2V ± 0.2V | |
| | (7) RL | | | 34 -3 | | | : OFF | 0V ON AIR (IND) goes off | |
| (8) TXB | 5 -1 | IF | VR6 | SEND SW: ON | 8.8V ± 0.1V | | | | |
| (9) TXB | 5 -1 | | | SEND SW: OFF | 0V | | | | |
| (10) LI BATT | | CONTROL | + | | | More than 3.0V | | | |

CONTROL ADJUSTMENT

| Item | Condition | Measurement | | | Adjustment | | | Specification | Remarks | | |
|--|--|----------------|------|--------------|-------------------|----------|---------------------|---------------------|---------------------|---------------------|------------------------|
| | | Test equipment | Unit | Terminal | Unit | Parts | Method | | | | |
| 1. Adjustment of standard oscillation | (1) Use synoscope probe (2) 24MHz | F COUNTER | CONT | TP3 | CONT | TC1 | ADJ to 24,000,000Hz | ± 7Hz | | | |
| 2. Voltage adjustment and confirmation | (1) VCO3 (2) Display: 50.050.0MHz (3) MODE: FM | DC VM | | TP1 | | L6 | ADJ to 6.8V | 6.8V (FM) | Confirm | | |
| | | | | | | | | 2.1V ± 0.3V (LSB) | | | |
| | (4) VCO2 | | | TP2 | | L20 | ADJ to 6.8V | 6.8V (FM) | Confirm | | |
| | | | | | 1.7V ± 0.3V (USB) | | | | | | |
| 3. CAR LEVEL | (1) CAR | RF V.M | | Hot terminal | | TC2 | ADJ to 0.32V | 0.32V (1.0V P-P) | | | |
| 4. VCO COIL | (1) Display: 51.025MHz | RF VM | CONT | D3 ANODE | CONT | T1 | ADJ to MAX output | About 0.32V | 48MHz MATCHING COIL | | |
| | (2) Display: 28.025MHz | | | | | T2 | | About 0.2V | 24MHz MATCHING COIL | | |
| | (3) Display: 7.025MHz | | | | | T3,4 | | About 0.25V | 6MHz MATCHING COIL | | |
| | (4) Display: 21.025MHz | | | | | IC2 14 | T5,6 | | About 0.54V | 18MHz MATCHING COIL | |
| | (5) Display: 21.025MHz | | | | | D3 ANODE | T7 | | About 0.2V | | |
| | (6) Display: 50.025MHz MODE: USB | | | | | IC12 2 | T8,9,10 | | About 0.24V | 48MHz BPF COIL | |
| | (7) Display: 28.025MHz MODE: USB | | | | | | T11,12 | | About 0.35V | 24MHz BPF COIL | |
| | (8) Display: 21.025MHz MODE: USB | | | | | IC12 3 | T13,14 | | About 0.25V | 18MHz BPF COIL | |
| | (9) Display: 7.025MHz MODE: USB | | | | | | T15,16 | | About 0.24V | 6MHz BPF COIL | |
| | (10) CAR output | | | | | IC8 1 | T17,18 | | About 0.15V | 2.83MHz BPF COIL | |
| | (11) CAR output | | | | | | Hot terminal | T19,20 TC2 | ADJ to 0.32V | 0.32V | 8.831MHz BPF COIL |
| | (12) Display: 51.025MHz MODE: USB | | | | | | D9 ANODE | T21,22 | ADJ to MAX output | About 0.35V | 0.15 - 0.4MHz BPF COIL |

TS-670

ADJUSTMENT

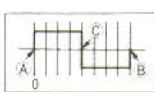
| Item | Condition | Measurement | | | Adjustment | | | Specification | Remarks | | | | | |
|-----------------------------------|---|----------------|------|-----------------|--------------------------------------|-------------|-------------------------------------|---|--|------|-----|---|--|---|
| | | Test equipment | Unit | Terminal | Unit | Parts | Method | | | | | | | |
| | (13) Display: 50.025MHz Connection •IC12 1 SWEEP •Q31 E Detector | SWEEP SCOPE | CONT | IC12 2 Q31 E | CONT | T23,24 | Adjust to 8.5MHz as shown at right. |  | 1.05 - 7.55MHz BPF COIL | | | | | |
| 5. Encoder adjustment | (1) Remove the VFO knob and motor-drive the encoder at approx. 300rpm. | SCOPE | CONT | 4 -3 | Encoder | VR1 | |  | Point C may be located anywhere. When a motor is not available, manually turn the VFO to check the duty ratio. | | | | | |
| | (2) EN1 duty ratio adjustment: Turn a motor CW and CCW. | | | | | | | | | | | | | After adjusting with the VFO control turned CW, check that internals D and E are also identical when the VFO control is turned CCW. |
| | (3) EN2 duty ratio adjustment: Turn a motor in the both direction. | | | | | | | | | 4 -2 | VR2 | Adjust until intervals D and E are equal to each other with point C placed at the center. | | |
| 6. VCO adjustment | (1) Voltage adjustment MODE: FM | DC VM | RF | TP5 | RF | | | | | | | | | |
| | 7.990 7.499MHz | | | | | T28 | ADJ to 6.0V | 6.0V | | | | | | |
| | 6 660 6.600MHz | | | | | | | 1.5V ~ 2.5V | Confirm | | | | | |
| | 24 790 24.790MHz | | | | | T29 | ADJ to 6.5V | 6.5V | | | | | | |
| | 21 000 21.000MHz | | | | | | | 1.3V ~ 2.2V | Confirm | | | | | |
| | 29 990 29.999MHz | | | | | T30 | ADJ to 6.5V | 6.5V | | | | | | |
| | 24 800 24.800MHz | | | | | | | 1.3V ~ 2.2V | Confirm | | | | | |
| | 53 990 53.999MHz | | | | | T31 | ADJ to 6.5V | 6.5V | | | | | | |
| | 50 000 50.000MHz | | | 1.3V ~ | Confirm | | | | | | | | | |
| (2) All BAND 7.00MHz 53.000MHz | RF VM | | TP3 | | Confirm all BAND by pushing BAND SW. | 0.9V ~ 2 dB | Comfirm | | | | | | | |

RX ADJUSTMENT

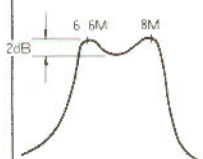
| Item | Condition | Measurement | | | Adjustment | | | Specification | Remarks |
|-------------|--|----------------------|------|--------------|------------|-------|-------------------------------------|--|---------|
| | | Test equipment | Unit | Terminal | Unit | Parts | Method | | |
| 1. RX B-P-F | (1) Display: 7 MHz BAND MODE: FM Connection •RF U 2 : SWEEP •RF U D3: DETECTOR •Preset core of RF U ,T2,T3,T19 att the way inside. P.S 1 : T2,3,19 is IF trap coil See item No. 4 2 : 7,12,28MHz BANDS are adjust under TX BPF | SWEEP SCOPE DETECTOR | RF | D3 (cathode) | RF | | Confirm waveform as shown at right. | 6.6M 8M 2dB  | Confirm |

ADJUSTMENT

| Item | Condition | Measurement | | | Adjustment | | | Specification | Remarks |
|-------------|---|------------------------------|------|--------------|------------|--|--|--|--|
| | | Test equipment | Unit | Terminal | Unit | Parts | Method | | |
| 1. RX B-P-F | (2) Display: 21MHz BAND | SWEEP SCOPE DETECTOR | RF | D3 (cathode) | RF | | 1dB 21M 22M | 23M | Confirm |
| | (3) Display: 28MHz BAND | | | | | | 24M 26.5M 3dB | 30M | |
| | (4) Display: 50MHz BAND | | | | | | T4,5,6 7,8 | 2dB 50M 52M | |
| 2. NULL | (1) RF GAIN VR: CCW MAX IF SHIFT VR: CENTER | RF VM | IF | R46 | IF | TC1 VR1 | LEVEL MIN adjust back and forth. | | |
| 3. RX AMP | (1) Display: 7.150MHz MODE: CW SSG OUT: -6 dB RF GAIN VR: CW MAX | AF VM SSG SCOPE S.P | | EXT.SP | IF | L1,2 L4 | ADJ AF output MAX. | | * L2 must realign at FTEM6 S. meter. * T24 will realign at NB alignment. |
| | | | | | RF | T20 T22 T23 T24 T25 VR1 | ADJ AF output MAX. Repeat 2~3 times this ADJ. | | |
| 4. IF TRAP | (1) Display: 7.990MHz SSG display: 8.830MHz SSG ATT: 80dB | AFVM SSG SCOPE S.P | IF | EXT.SP | RF | T2,3 T19 | Align to MIN order as T19, 2, 3. | More than 70dB | |
| 5. NB AMP | (1) Display: 50MHz BAND ANT: NOISE GENERATOR NB SW: ON | N.G. SCOPE S.P | IF | EXT.SP | RF | T26,27 T24 | •Adjust T26,27 to will work point dec- reasing N.G output. •Align slug out point. | Confirm under high input (SSG + 30dB) and low input (SSG + 3 dB). | |
| 6. S METER | (1) Display: 28.900.0MHz MODE: CW NO SIGNAL | SSG | | S meter | IF | VR3 | Set to mechanical start point. | | |
| | | | | | RF | T9 | ADJ AF output MAX. | | |
| | (2) SSG OUT: 8dB | SSG | IF | S METER | IF | L2 | S1 adjust CCW from peak (turn stug out) | S1 (8 ± 3dB) | Confirm |
| | (3) SSG OUT: 30dB | | | | | VR4 | S9 | S9 (30 ± 6dB) | |
| | (4) S-1, S-9 | | | | | | Adjust repeat (2.), (3). | | |
| | (5) MODE: FM SSG OUT: 30dB (MOD 1kHz DEV 5kHz) | | | | FM | VR2 | Adjust at 52.010.00 | RF meter "20" (30 ± 6dB) | |

TS-670

ADJUSTMENT

| Item | Condition | Measurement | | | Adjustment | | | Specification | Remarks |
|--------------|---|----------------|------|----------|----------------|-----------|---|---|----------|
| | | Test equipment | Unit | Terminal | Unit | Parts | Method | | |
| 7. AGC | (1) SSG OUT: 30dB MODE: CW, AM : SSB | | | | | | | CW, AM—FAST SSB—SLOW | Confirm |
| 8. SQ | (1) MODE: SSB SQ VR: 12 o'clock | | | | IF | VR2 | Adjust VR slowly and step at threshold. | | Confirm |
| | (2) MODE: FM | | | | | | | 8:30 ~ 9:30 | |
| 9. BEEP tone | (1) AF GAIN VR: CENTER BAND SW: UP AND DOWN Connect IF U 27 hot line to GND. | AF VM SCOPE | | EXT.SP | IF | VR5 | Adjust "PEE" tone. | 100mV | |
| 10. RIT | (1) RIT: CENTER SSG OUT: 10dB RIT SW: ON OFF | | | | SW | VR5 | RIT SW ON, OFF equal level | Same AF tone. RIT RIT ON, RIT IND light on. | |
| | | | | | FRONT PANEL | RIT VR | | | ± 1.1kHz |
| 11. RF ATT | | | | | | | RF ATT ON, OFF | About 30dB DOWN | Confirm |

TX adjustment

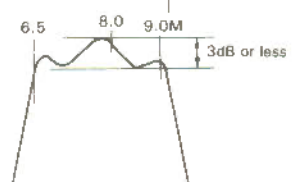
| Item | Condition | Measurement | | | Adjustment | | | Specification | Remarks | | | | |
|------------------------|--|---|-------|---------------|------------|----------------------------|---|--|---|--------------|-----|--|--|
| | | Test equipment | Unit | Terminal | Unit | Parts | Method | | | | | | |
| 1. Base current | (1) Display: 28.800MHz MODE: USB MIC VR: CCW MAX RF PWR VR: CCW MAX FILTER U : VR1, VR2 CCW MAX | DC AM | FINAL | A | FINAL | VR1 | If adjustment to 300mA is not possible. 200mA or more at position where reduced about 10mA from about 10mA from VR MAX. | 300mA (200 ~ 300mA) | | | | | |
| |  FILTER UNIT | | | | | | | | | B | VR2 | | 200mA |
| | SEND SW: ON | | | | | | | | | | | | |
| | (2) SEND SW: OFF POWER SW: OFF | | | | | | | | | | | | |
| | (3) POWER SW: ON | | | | | | | | | | | | |
| 2. POWER | (1) Display: 52.000.000MHz MODE: CW RF PWR VR: CW MAX FILTER U VR1,2: CW MAX RF U TC4: MAX CAP IF U VR9: CENTER RF U DRV Connect terminal SEND SW: ON FINAL U TC1: MAX CAP | POWER METER SCOPE | | ANT (50-7) | RF | TC1 2 3 T41 42 | •Adjust to MAX power output. •Repeat adjust RF U TC1 ~ 3. | | | | | | |
| | | | | | | | | | | IF | L10 | | |
| | | | | | | | | | | FINAL | TC1 | If power is over 10W reduce to 10W with VR and adjust. | |
| | SEND SW: OFF | | | | | | | | | | | | |
| 3. TX-BPF | MODE: FM Connection RF U R123: SWEEP RF U VR2: CCW MAX RF U DRV: 50Ω DUMM and SPECTRUM ANA- LYZER | SWEEP SPECT- RUM ANALY- ZER 50Ω DUMMY | | | | | Adjust us shown at right with MAX gain and band width. | *Following wave- form has measured 2 dB/div scale. |  | | | | |
| (1) Display: 7MHz BAND | RF | | | | | | | | | 50Ω DUMMY | RF | T12 15 18 | Slug out over 3 turn on RF U T34, 35 |

ADJUSTMENT

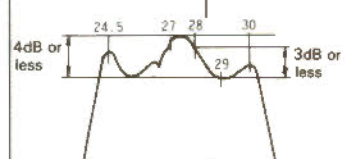
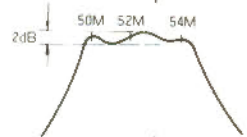
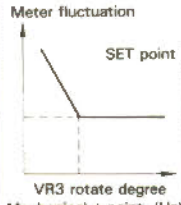
| Item | Condition | Measurement | | | Adjustment | | | Specification | Remarks |
|--------------|---|----------------------------|------|-------------|------------|-----------------------|---------------------------------|---|-----------|
| | | Test equipment | Unit | Terminal | Unit | Parts | Method | | |
| | SEND SW: ON (2) Display: 21MHz BAND | | | | | T11 14 17 | |  | |
| | (3) Display: 28MHz BAND | | | | RF | T10 13 16 | |  | |
| | (4) Display: 50MHz BAND | | | | | TC3 2 T37 42 | TC3,2 has adjusted for gain up. |  | |
| | SEND SW: OFF | | | | | | | | |
| 4. POWER SET | (1) Display: 53.999MHz MODE: USB AG OUT: 1.5kHz 10mV SEND SW: ON adjust power to 15W by MIC VR. | POWER METER AG AF VM | | ANT 50-7 | FILTER | VR2 | Adjust to 11W | 11W | |
| | (2) RF PWR VR: CCW | | | | SW | VR9 | Adjust to 1.5W | 2.5W or less | |
| | (3) SEND SW: OFF | | | | | | | | |
| | (4) MODE: CW RF PWR VR: CW MAX SEND SW: ON | | | | IF | VR9 | Adjust to 11W | | |
| | (5) Confirm power each BAND edge. | | | | | | | | 10W ~ 12W |
| 5. ALC METER | (1) MODE: USB MIC VR: CCW MAX RF PWR VR: CW MAX SEND SW: ON RF/ALC SW: ALC | POWER METER AG AF VM | | METER | FILTER | VR3 | Adjust mechanical ϕ point. | Meter fluctuation SET point  | |
| | (2) AG out: 1.5kHz 5mV MIC VR: set to S1 | | | | | VR4 | AG out: increase 6dB from 5mV. | Adjust ALC full scale. | |
| | (3) MIC input: OFF RF PWR VR: CCW MAX | | | | | | | No ALC METER swing | |
| | SEND SW: OFF | | | | | | | | Confirm |

TS-670

ADJUSTMENT

| Item | Condition | Measurement | | | Adjustment | | | Specification | Remarks | | | |
|--------------------------------|---|--|------|-------------------------------|------------|-------------------|---|---------------------|---------|-----------------------------|--------|--|
| | | Test equipment | Unit | Terminal | Unit | Parts | Method | | | | | |
| 6. PROTECTION | (1) Display: 53.499MHz MODE: CW RF PWR: CW MAX FILTER U VR1: CCW MAX SEND SW: ON | POWER METER V METER | | ANT (50-7) Both end of VR1 | FILTER | TC1 | Minimum voltage | About 100mV or less | | | | |
| | SEND SW: OFF | | | | | | | | | | | |
| | (2) Display: 21.499MHz : 28.499MHz ANT: 150Ω load SEND SW: ON | | | | | | | | | POWER METER 150Ω LOAD | | |
| SEND SW: OFF | | | | | | | | | | | | |
| | (3) Confirm at 4 points 7.499MHz, 50.499MHz 52.499MHz, 53.499MHz | | | | | | | 4W or more | | | | |
| | | | | | | | | | | | | |
| 7. SPRIOUS | (1) Display: 50.000MHz MODE: CW SEND SW: ON | POWER METER SPE-ANA | | ANT (7-50) | RF | VR2 VR4 T33 | Adjust to minimize spurious at ±8.83MHz (Repeat VR2, 4 twice) | 60dB or less | | | | |
| | SEND SW: OFF | | | | | | | | | | | |
| | (2) Confirm at 52.990MHz | | | | | | | | | | | |
| | (3) Display: 53.999MHz MODE: AM SEND SW: ON | | | | | | | | | CONT | VR1 | Adjust to MIN spurious at ±100kHz |
| | (4) Display: 21.499MHz SEND SW: ON | | | | | | | | | RF | VR3 | Adjust to minimize spurious. |
| | (5) Display: 7.499MHz | | | | | | | | | | T34,35 | Adjust minimize spurious at ±1.33MHz. (Repeat T34, 35 twice) |
| SEND SW: OFF | | | | | | | | | | | | |
| 8. SSB MODE FREQUENCY RESPONSE | (1) AG out: 5mV | | | | CONTROL | DIP S/W | | | | | | |
| | <p>SEND SW: ON MIC VR: 9 o'clock</p> | | | | | | | | | | | |
| | SEND SW: OFF | | | | | | | | | | | |
| 9. CAR BALANCE | (1) Display: 28.8MHz MODE: USB, LSB MIC VR: CCW MAX RF POWER VR: CW MAX SEND SW: ON | POWER METER SCOPE AG 2 SET AF VM | | ANT (7-50) | IF | VR7 VR8 | Adjust repeatedly to minimize. | -50dB or less | | | | |
| | SEND SW: OFF | | | | | | | | | | | |

ADJUSTMENT

| Item | Condition | Measurement | | | Adjustment | | | Specification | Remarks |
|----------------------------|--|--------------------------|------|-----------|------------|--------------------|---|---|---------|
| | | Test equipment | Unit | Terminal | Unit | Parts | Method | | |
| 10. TX. RF FREQ-ENCY ERROR | RF POWER: CCW MAX MODE: USB, LSB, CW | POWER METER F COUNTER | IF | 30 -1 | SW | VR7 VR8 VR10 | SEND: Adjust at OFF as ON frequency USB LSB CW | USB: LSB: TX.RX equal frequency CW: Same as USB frequency | |
| 11. RF POWER METER | (1) MODE: FM RF PWR: CW MAX SEND SW: ON RF/ALC SW: RF | POWER METER | | ANT METER | FILTER | VR5 | RF PWR VR: Adjust to 10W. | RF METER "10" | Confirm |
| | (2) RF PWR VR: Adjust 2W | | | | | | Confirm | RF METER 2W ± 1W | |
| | SEND SW: OFF | | | | | | | | |
| 12. HF: VHF LEVEL ERROR | (1) Display: 53.499MHz, 7.499MHz MODE: CW SEND SW: ON RF/AFC SW: ALC | POWER METER | | METER | RF | TC4 | Adjust to equal fluctuation on ALC meter between 53.499MHz and 7.499MHz | If 53.499 is low as 7.499 adjust to MAX and within 6dB. | |
| | SEND SW: OFF | | | | | | | | |
| 13. SIDE TONE | (1) MODE: CW AF GAIN VR: 12 o'clock KEY JACK: KEY SEND SW: ON | POWER METER AF VM | | EXT.SP | IF | VR10 | KEY DOWN | 0.63V/80 about 800Hz Low distortion. | Confirm |
| 14. CW BREAKE IN | (1) SEND SW: OFF | | | | RF | | | | |

TS-670

ADJUSTMENT

MICROPROCESSOR OPERATION CHECK

| Item | Condition | Measurement | | | Adjustment | | | Specification | Remarks |
|-------------|--|-----------------|---------|----------|------------|-------|---|--|-------------------------------|
| | | Test equipment | Unit | Terminal | Unit | Parts | Method | | |
| 1. BAND | (1) POWER PLUG: CONNECT : (13.8V) POWER: ON | | | Display | | | | METER CAMP: light on VFO A 50.000.00 | |
| | (2) UP: Push | | | | | | | Display: 51.000.00 Confirm "PEE" tone. | Confirm light doesn't change. |
| | (3) UP: Continue push | | | | | | | 7.000.00—21.000.00—28.000.00 ↓ 29.000.00 ↓ 50.000.00 ↓ 53.000.00—52.000.00—51.000.00 | |
| | (4) DOWN: Push | | | | | | Confirm light doesn't change. | Display changes down 1MHz or 1 BAND and "PEE" TONE. | |
| | (5) DOWN: Continue push | | | | | | | Back words of UP switch. | |
| 6. FUNCTION | (1) ANT: 7 - 28, 50 ANTS A/B SW: VFO A and VFO B MODE: ULB | POWER METER SET | DISPLAY | DISPLAY | | | SEND SW OFF—ON—OFF | VFO A shows VFO A VFO B shows VFO B | |
| | SPLIT: ON A/B SW: VFO B | | | | | | SEND SW OFF ↓ ON ↓ OFF | VFO B ↓ VFO A As display ↓ VFO B | |
| | A/B SW: VFO A | | | | | | | Back words function of VFO B | |
| | SPLIT SW: ON | | | | | | | | |
| 3. F. STEP | (1) F. STEP: OFF MODE: SSB, CW, AM | | | | | | Confirm frequency change: CW: High freq. CCW: Low freq. | One knob rotate about 10kHz change | |
| | (2) F. STEP: ON | | | | | | | About 100kHz change IND light on | |
| | (3) MODE: FM | | | | | | | About 100kHz change | |
| | (4) F. STEP: OFF | | | | | | | About 500kHz change IND light on | |
| 4. F. LOCK | (1) F. LOCK: ON | | | | | | Confirm by knob rotate. | Display doesn't change. IND light on | |
| | (2) F. LOCK: OFF | | | | | | | IND goes off | |
| 5. MEMORY | (1) POWER OFF—ON HOLDING HOLD SW. | | | | | | | Display: VFO A : 50.000.00 : USB All RESET | |
| | (2) VFO/MEMO: ON | | | | | | Confirm each memo by 10 KEY which frequency has same as entered previously. | Confirm all memo call back. | |
| | (3) MS: ON | | | | | | Confirm at SEND SW ON, OFF. | Scan time: about 2 sec. each channel. | |

ADJUSTMENT/PACKING

| Item | Condition | Measurement | | | Adjustment | | | Specification | Remarks |
|-----------------|--|----------------|------|----------|------------|-------|--|---|---------|
| | | Test equipment | Unit | Terminal | Unit | Parts | Method | | |
| | (4) HOLD: ON | | | | | | | STOP SCAN | |
| | (5) 10 KEY: "1" PUSH HOLD: OFF F. LOCK: ON | | | | | | | Confirm display has changes by DIAL and BAND knob. IND light on | |
| | (6) VFO/MEMO: ON | | | | | | | Starts SCAN | |
| 6. PROGRAM SCAN | (7) VFO/MEMO: OFF F. LOCK: OFF | | | | | | | IND goes off | |
| | PS. G: ON | | | | | | Confirm frequency has change from 8 CH MEMO to 9 CH MEMO which is within 1MHz. | IND light on | |
| | F. STEP ON-OFF | | | | | | | SCAN speed has change | |
| | PS. G: OFF | | | | | | | IND goes off | |
| 7. ENTER | (1) VFO/MEMO: VFO A ENT: ON 10 KEY: 5 3 2 1 0 1 ENT: ON | | | | | | | Display: 53.210.1 IND light on | |
| | (2) ENT: ON 10 KEY: 0 7 ENT: ON | | | | | | | Display: 7.000.0 | |

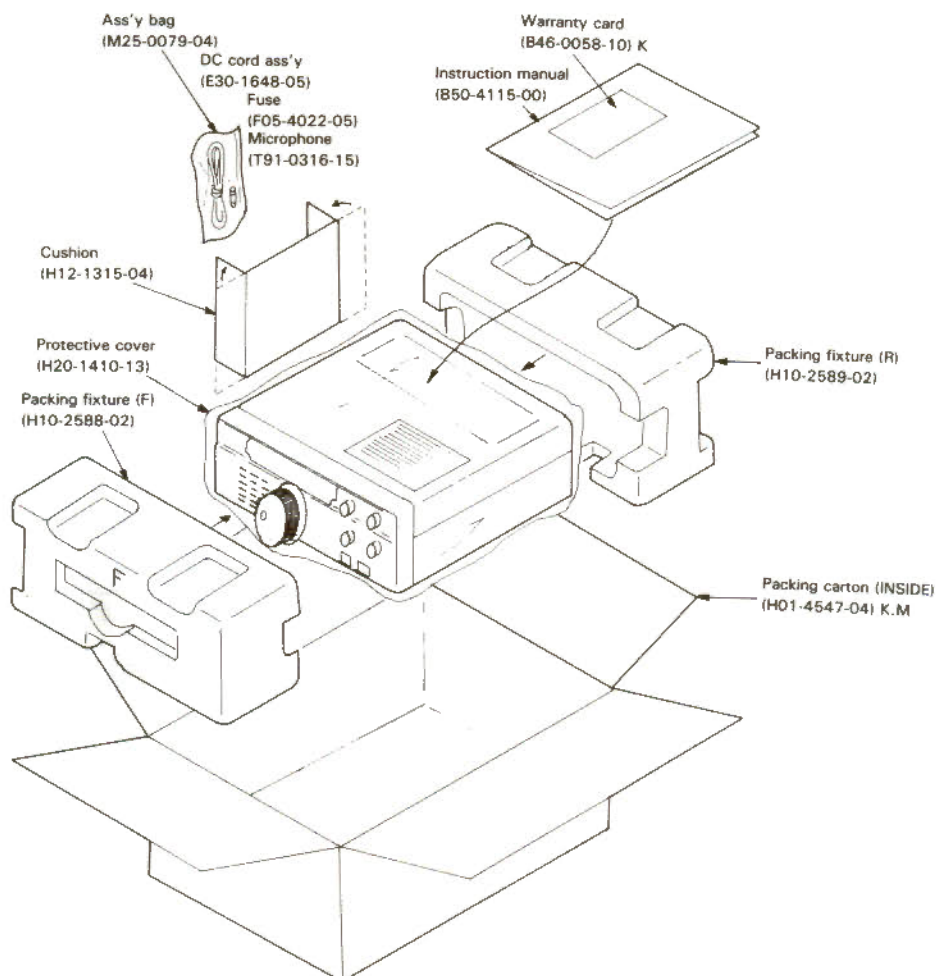

TS-670

ADJUSTMENT

ADJUSTMENT PART LOCATION (TOP VIEW)

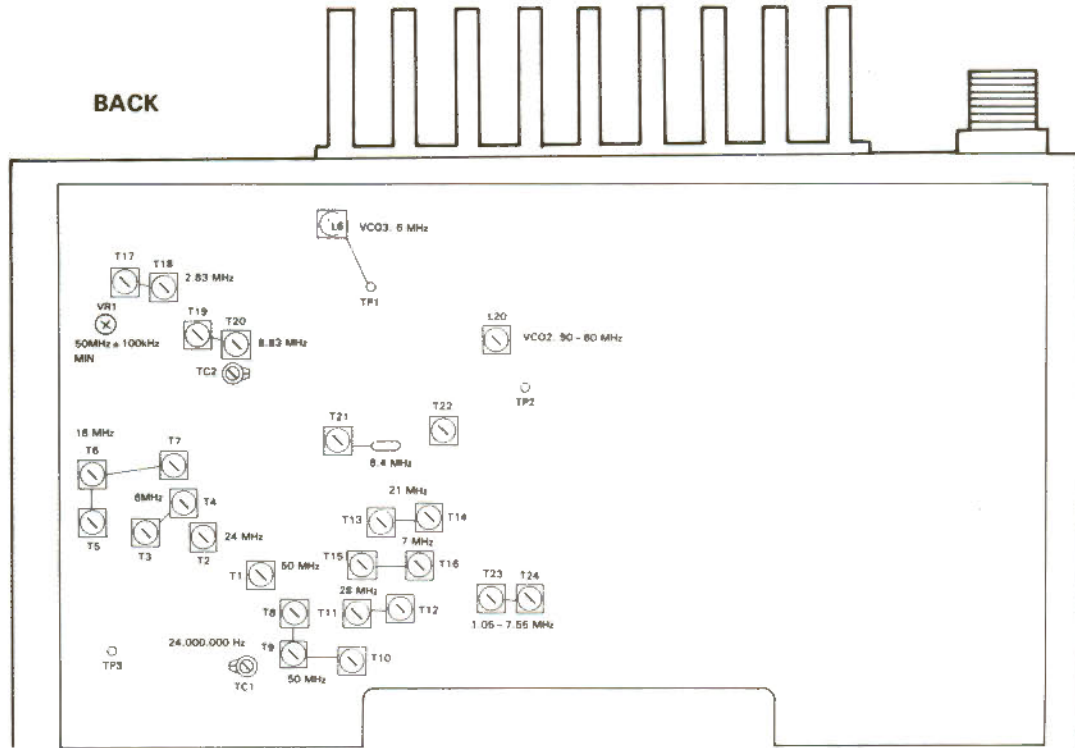

CONTROL UNIT (X53-1370-00)

IF UNIT (X48-1390-00)

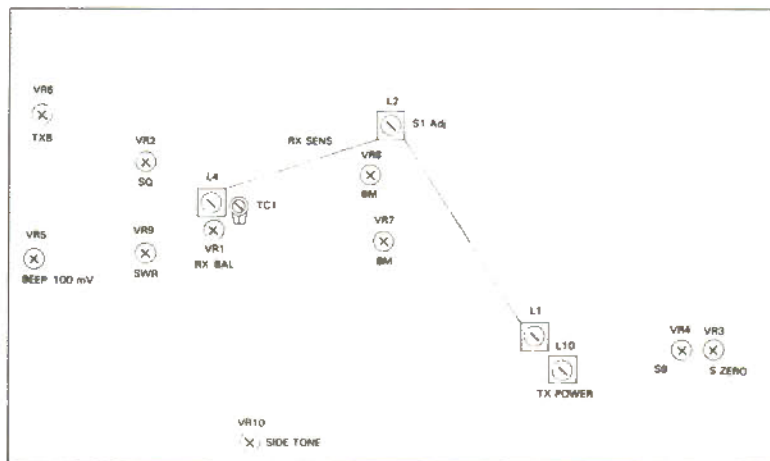

FM-430 UNIT (X48-1340-01) (Option)

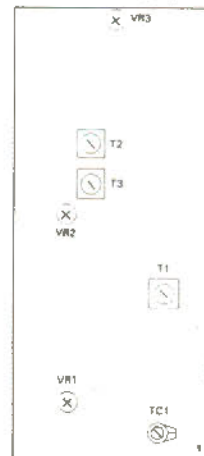

ENCODER UNIT (W02-0328-10)



SWITCH UNIT



SWITCH UNIT

FRONT

ADJUSTMENT

ADJUSTMENT PART LOCATION (BOTTOM VIEW)

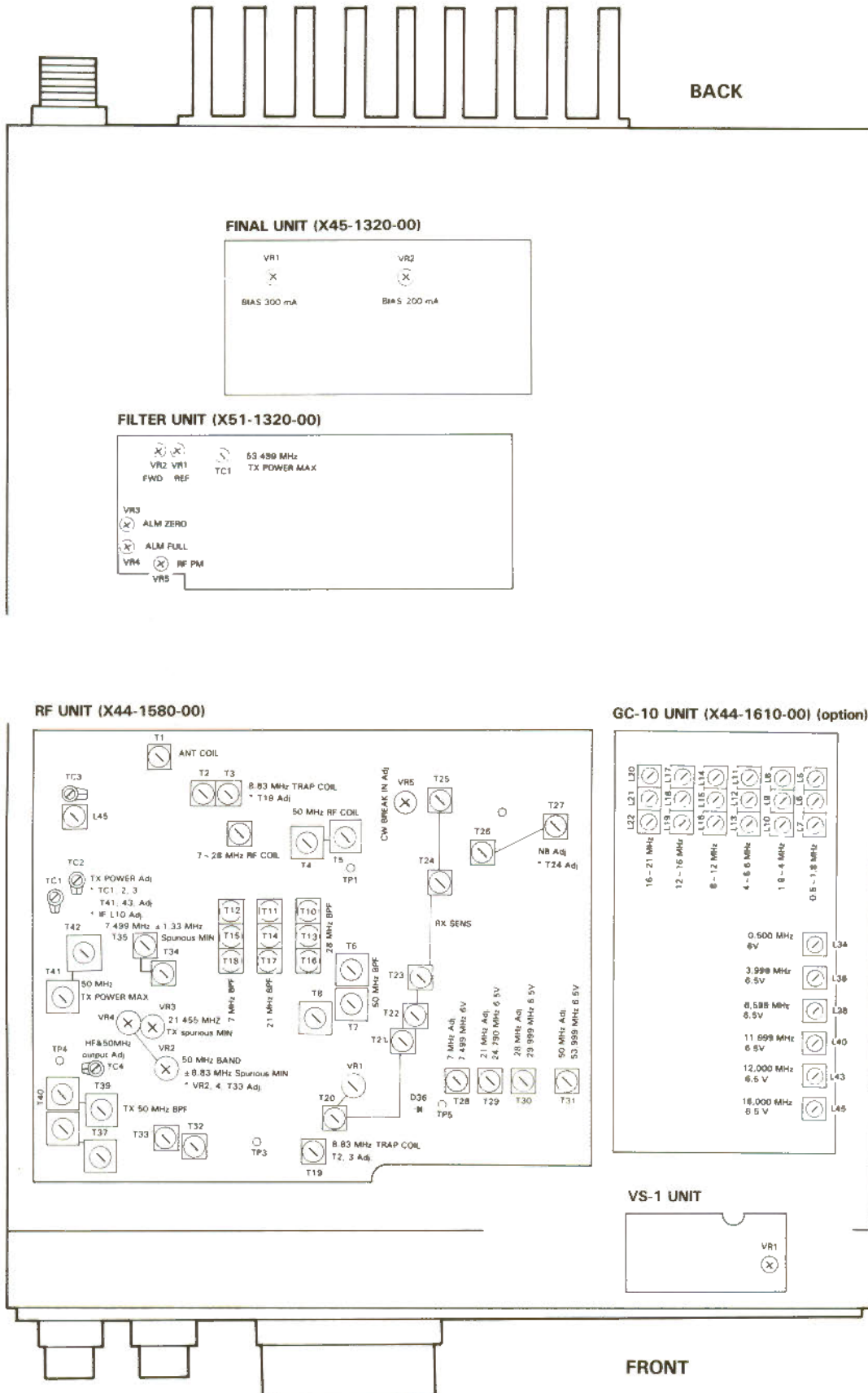

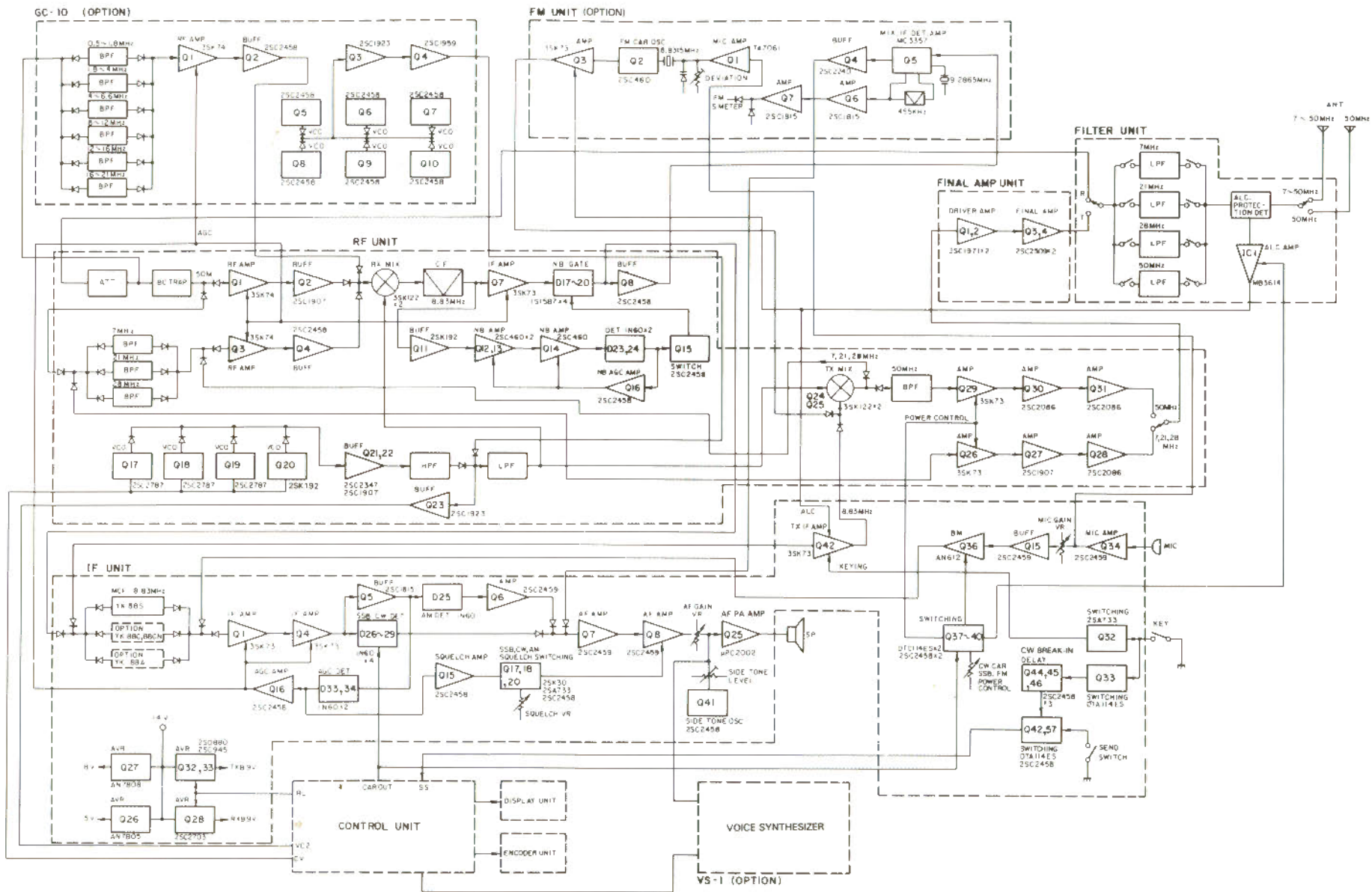

BLOCK DIAGRAM

TS-670

TS-670 DISASSEMBLY

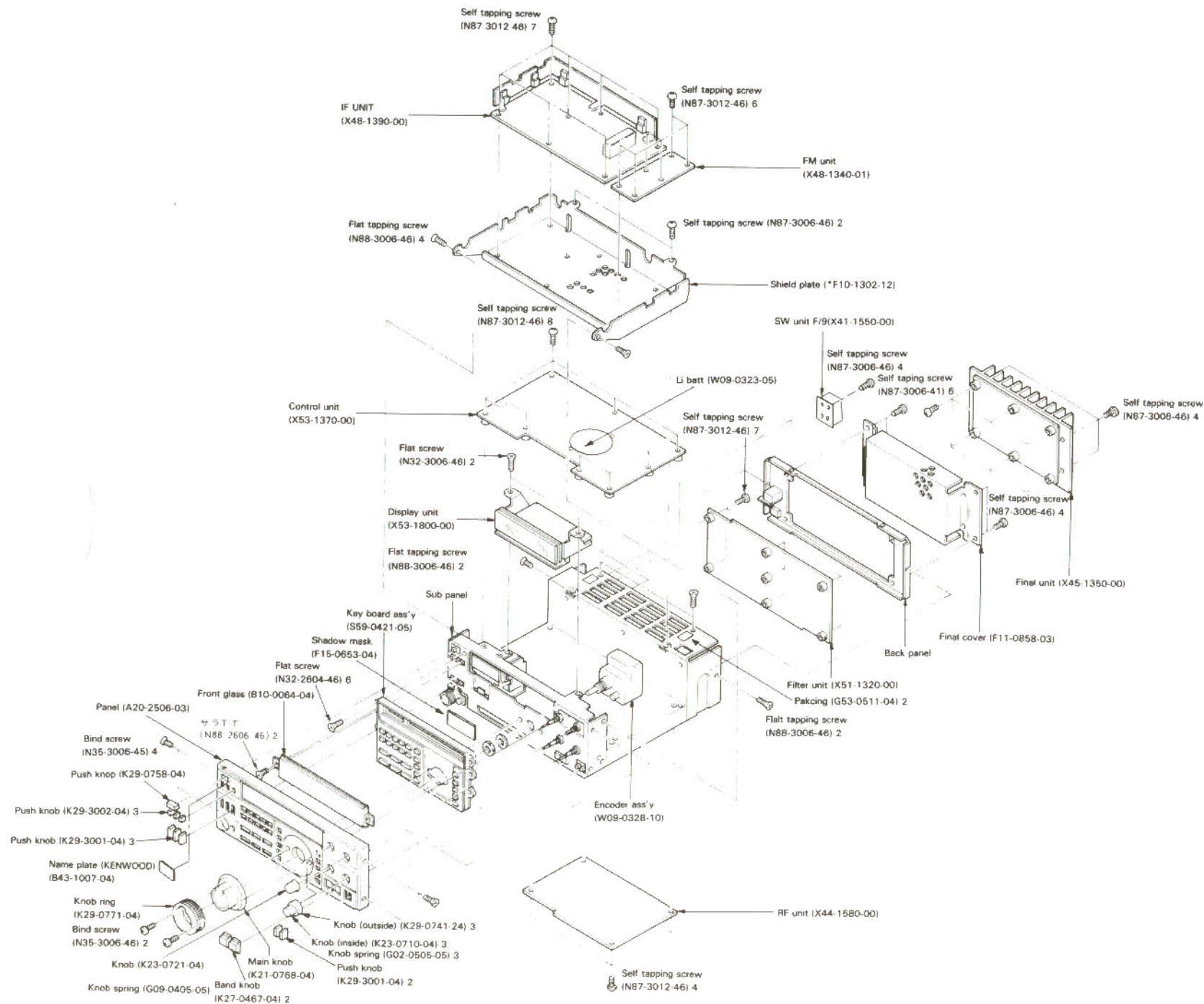

DISASSEMBLY

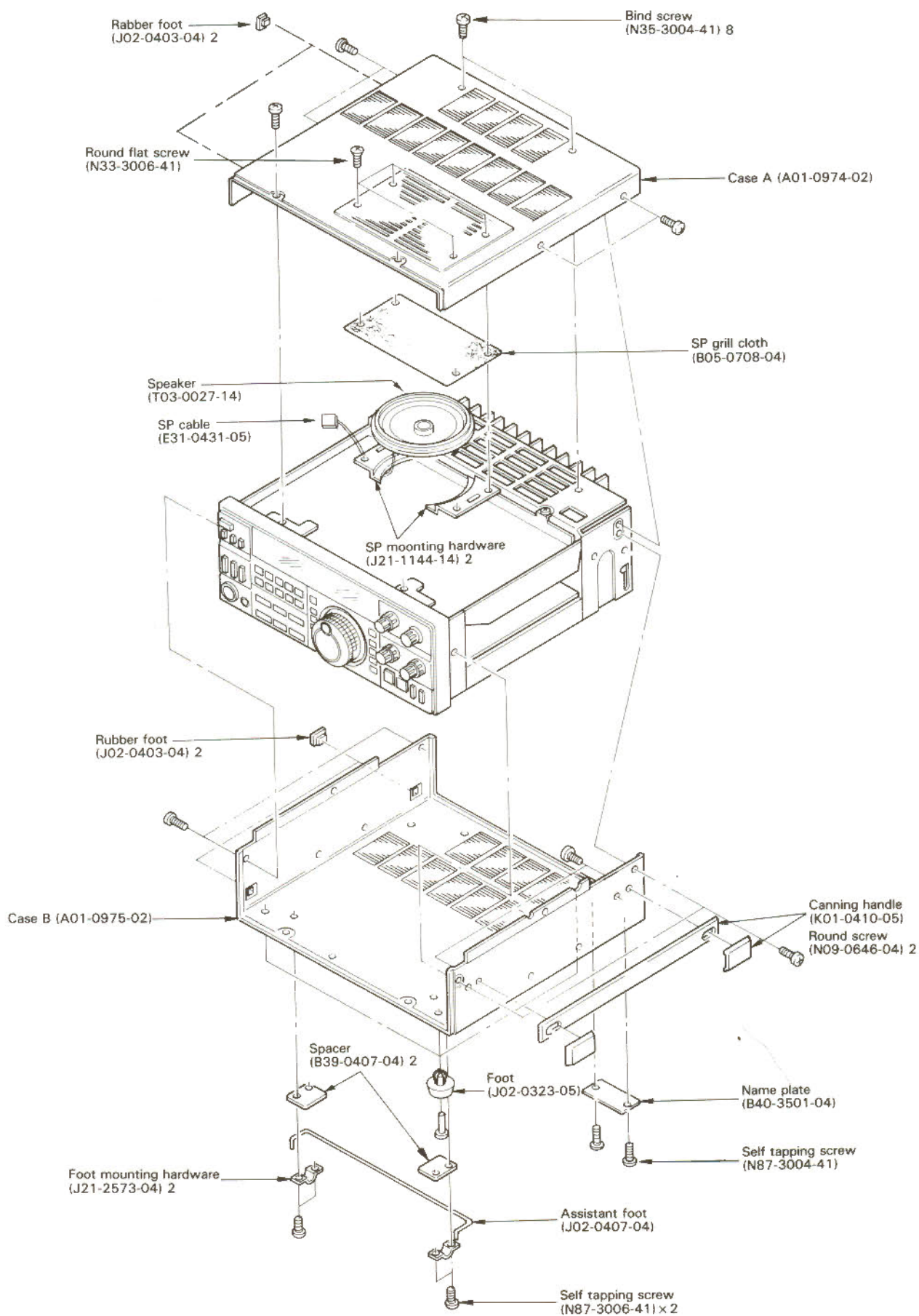

TS-670

TERMINAL FUNCTIONS

| Connector No. | Terminal No. | Terminal name | Function |
|----------------------------------|--------------|---------------|--|
| SWITCH UNIT (X41-1550-00) | | | |
| (A/9) | 1 | RFB | RF GAIN VR voltage output |
| | 2 | IFB | IF SHIFT VR voltage output |
| | 3 | RIB | RIT VR voltage output |
| (A/9) | 1 | MIN | RF PWR VR GNDMIN voltage AOS |
| | 2 | PCV | RF PWR VR control voltage output |
| | 3 | GND | |
| | 4 | FSQ | FM SQUELCH VR input |
| | 5 | SSQ | SSB SQUELCH VR input |
| | 6 | LSB | LSB IF SHIFT VR input |
| | 7 | USB | USB IF SHIFT VR input |
| | 8 | CW | CW IF SHIFT VR input |
| | 9 | 8 V | 8 V LINE |
| (A/9) | 1 | MV2 | MIC VR output |
| | 2 | GND | MIC VR GND |
| | 3 | GND | MIC VR GND |
| | 4 | MV3 | MIC VR input |
| | 1 | RFB | RF GAIN VR input |
| | 2 | IFB | IF SHIFT VR input |
| | 3 | RIB | RIT VR input |
| | 1 | AV2 | AF GAIN VR output |
| | 2 | GND | AF GAIN VR GND |
| | 3 | GND | AF GAIN VR GND |
| | 4 | AV3 | AF GAIN VR input |
| | 5 | RIT | RIT VR output |
| | 6 | IFS | IF SHIFT VR output |
| | 7 | RFG | RF GAIN VR output |
| | 8 | GND | RIT VR GND IF SHIFT |
| (C/9) | 1 | BU | BAND UP switch MAKE (ON CONTACT) |
| | 2 | BCD | BAND switch common (GND) |
| | 3 | BCD | BAND switch common (GND) |
| | 4 | BD | BAND DOWN switch MAKE (ON GND) |
| (E/9) | 1 | BCD | 1 MHz STEP switch common (GND) |
| | 2 | BCD | 1 MHz STEP switch common (GND) |
| | 3 | RCO | RIT switch common |
| | 4 | RST | RIT switch side |
| | 5 | MHS | 1 MHz STEP switch ON side (ON GND) |
| (I/9) | 1 | RFM | RF/ALC switch RF meter |
| | 2 | SM | RF/ALC switch common |
| | 3 | SM | RF/ALC switch common |
| | 4 | ALM | RF/ALC switch ALC meter |
| | 5 | NBS | NB switch (ON GND) |
| | 6 | VS | VOICE switch (Push GND) |
| (I/9) | 1 | SCC | WIDE/NAR switch CW common |
| | 2 | CWW | WIDE/NAR switch CW WIDO |
| | 3 | CWN | WIDE/NAR switch CW NARROW |
| | 4 | AMN | WIDE/NAR switch AM NARROW |
| | 5 | AMC | WIDE/NAR switch AM common |
| | 6 | AMW | WIDE/NAR switch AM WIDE |
| | 7 | ATS | ATT switch (OFF open, ON GND) |
| | 8 | SS | REC/SEND switch (SEND GND) = SS LINE |
| (F/9) | 1 | 14 A | 14 V LINE (after choke coil) |
| | 2 | 14 | 14 V LINE (in front choke coil = after POWER switch) |
| (G/9) | 1 | SPO | PHONES AF input |
| | 2 | GND | PHONES GND |
| (G/9) | 1 | GND | PHONES GND |
| | 2 | PHONE | PHONES SP output |

| Connector No. | Terminal No. | Terminal name | Function |
|------------------------------|--------------|---------------|--|
| (H/9) | 1 | GND | 14 No. 1 (terminal) |
| | 2 | SPK | AF input (SPEAKER) (EXT. SP jack, input) |
| (H/9) | 1 | GND | 13 No.1 (terminal) |
| | 2 | PHONE | inside SP AF output |
| (H/9) | 1 | STS | KEY side tone switch (KEY IN open) connected (terminal) |
| | 2 | CWD | |
| | 3 | CWD | KEY CW switch (KEY IN switch to No. 6 CWB) KEY signal output KEY CW switch input = CWB LINE |
| | 4 | CWS | |
| (F/9) | 1 | PS1 | POWER switch 14 V LINE LOAD side |
| | 2 | PS2 | POWER switch 14 V LINE outlet side |
| (F/9) | 1 | GND | DC: ⊖ input |
| | 2 | 14 | DC: ⊕ input |
| | 3 | 14 | DC: ⊕ input |
| (D/9) | 1 | SS | MIC: 2 = SS LINE |
| | 2 | MD | MIC: 3 = DOWN |
| | 3 | MIC | MIC: 1 = MIC HOT |
| | 4 | MU | MIC: 4 = UP |
| | 5 | GND | MIC: 7 = MIC GND |
| | 6 | 8 M | MIC: 5 = 8 V source |
| | 7 | SPO | MIC: 6 = AF output |
| RF UNIT (X44-1580-00) | | | |
| | 1 | DRV | DRIVE RF output |
| | 1 | RAT | RX ANT input |
| | 2 | GND | RX ANT GND |
| | 1 | GCA | GC-10: ANT output |
| | 2 | GND | GND |
| | 1 | NBS | Noise Blanker switch GND to ON |
| | 2 | ATS | GND to RF ATT ON |
| | 1 | 8 | 8 V input |
| | 2 | 14 | 14 V input |
| | 3 | AGC | AGC input |
| | 4 | -6 | -6 V input |
| | 1 | 8 | GC UNIT 8 V output |
| | 2 | 14 | GC UNIT 14 V output |
| | 3 | AGC | GC UNIT AGC output |
| | 1 | RXB | RX about 8.5 V input |
| | 2 | TBL | TX about 8.5 V output |
| | 1 | CWS | KEY IN signal • CWB has add when key in. |
| | 2 | CWD | CW Brake in time constant |
| | 3 | KEY | TRANSMITT when key down on CW |
| | 1 | RIF | IF output (8.83 MHz) |
| | 2 | GND | GND |
| | 1 | FMI | FM IF output (8.38 MHz) |
| | 2 | GND | GND |
| | 1 | 7 A | 7 MHz BAND information ON = L |
| | 2 | 21 A | 21 MHz BAND information ON = L |
| | 3 | 28 A | 28 MHz BAND information ON = L |
| | 4 | 50 A | 50 MHz BAND information ON = L |
| | 5 | SBK | RX Blanking pulse input at PLL switch |

TERMINAL FUNCTIONS

| Connector No. | Terminal No. | Terminal name | Function |
|------------------------------|--------------|---------------|--|
| | 1 | 7 A | 7 MHz BAND information |
| | 2 | 21 A | 21 MHz BAND information |
| | 3 | 28 A | 28 MHz BAND information |
| | 4 | 50 A | 50 MHz BAND information |
| | 5 | 14 | 14 V input |
| | 6 | ABB | 7, 21, 28, 50 MHz BAND USE = "H" (about 11.5 V) |
| | 1 | PB | PLL 8 V output |
| | 2 | VC2 | VCO output to CONT UNIT |
| | 3 | PG | PLL GND |
| | 4 | GND | GND |
| | 5 | CV | VCO control voltage |
| | 1 | CV | VCO control voltage |
| | 2 | GND | GND |
| | 1 | GCV | VCO input from GC-10 |
| | 1 | TIF | TX 8.83 MHz input |
| | 2 | GND | GND |
| | 1 | GND | GND |
| | 2 | FMT | FM TX 8.83 MHz input |
| | 1 | TXB | TX + 8.8 V |
| | 2 | G2 | Gain control voltage on TX |
| | 1 | GCO | RF input from GC-10 |
| | 2 | GND | GND |
| IF UNIT (X48-1390-00) | | | |
| | 1 | RIF | RX IF signal input |
| | 2 | GND | |
| | 1 | NC | |
| | 2 | AMF | AM Frequency shift signal |
| | 1 | AMC | Filter switch signal AM common |
| | 2 | CWN | Filter switch signal YK-88C |
| | 3 | AMW | Filter switch signal YK-88A |
| | 4 | CWW | Filter switch signal YK-88S |
| | 5 | AMN | Filter switch signal YK-88S |
| | 6 | SCC | Filter switch signal SSB, CW common |
| | 1 | SSB | SSB: 7 V |
| | 2 | CWB | CW: 7 V |
| | 3 | AMB | AM: 7 V |
| | 4 | NC | |
| | 5 | FMB | FM: 8 V |
| | 1 | TXB | TX: 8.8 V |
| | 2 | RXB | RX: 9 V |
| | 1 | TXB | TX: 8.8 V |
| | 2 | G2 | RF UNIT TX FET AMP G2 Control voltage |
| | 1 | MV2 | MIC VR 2 |
| | 2 | GND | |
| | 3 | GND | |
| | 4 | MV3 | MIC VR 3 |
| | 1 | GND | |
| | 2 | FMC | FM UNIT MIC ANP output |
| | 1 | MIC | MIC input |
| | 2 | GND | |
| | 1 | PCV | Power control VR signal |
| | 2 | MIN | Power control MIN power set |
| | 1 | GND | |
| | 2 | SP | SPEAKER |

| Connector No. | Terminal No. | Terminal name | Function |
|---------------|--------------|---------------|-------------------------------------|
| | 1 | SPO | |
| | 2 | GND | |
| | 3 | SPJ | |
| | 1 | TBL | CW key down about 8 V |
| | 2 | CWB | CW, about 7 V |
| | 3 | RXB | RX, about 9 V |
| | 1 | RL | TX about 13 V Relay control voltage |
| | 2 | RAL | Remote ALC input |
| | 1 | VO | Voice synthesizer signal |
| | 2 | GND | |
| | 3 | 8 V | DC 8 V |
| | 1 | TIF | TX output |
| | 2 | GND | |
| | 1 | ALC | ALC signal |
| | 2 | PCL | power control DC signal |
| | 3 | RL | TX about 13 V Relay control voltage |
| | 4 | FMB | FM about 8 V |
| | 5 | 8 V | DC 8 V |
| | 1 | GND | |
| | 2 | SPO | |
| | 1 | SM | S meter signal |
| | 2 | NC | |
| | 1 | GND | |
| | 2 | FAF | FM AF signal |
| | 3 | FMB | FM about 8 V |
| | 4 | FSQ | FM SQ |
| | 5 | TXB | TX about 8.8 V |
| | 6 | FSM | FM S meter signal |
| | 7 | ALC | FM ALC signal |
| | 1 | 8 V | DC 8 V |
| | 2 | -6 | DC -6 V |
| | 3 | 14 A | 14 V after choke coil |
| | i | 5 V | DC 5 V |
| | 1 | GND | |
| | 2 | 11 V | DC 11 V Display |
| | 1 | 14 A | 14 V after choke coil |
| | 2 | 14 | 14 V input |
| | 1 | RFG | RF gain control signal DC |
| | 2 | NC | |
| | 1 | AGC | AGC LINE |
| | 2 | 8 V | DC 8 V |
| | 3 | -6 | DC -6 V |
| | 4 | 14 A | 14 V after choke coil |
| | 1 | GND | |
| | 2 | BZ | BEEP TONE ON |
| | 1 | AV2 | AF VR 2 |
| | 2 | GND | |
| | 3 | GND | |
| | 4 | AV3 | AF VR 3 |
| | 1 | SSQ | SSB SQ VR |
| | 2 | FSQ | FM SQ VR |
| | 1 | GND | |
| | 2 | CAR | 8.83 MHz Carrier input |
| | 1 | NC | |
| | 2 | CWD | CW Brake in time constant control |

TS-670

TERMINAL FUNCTIONS

| Connector No. | Terminal No. | Terminal name | Function |
|-----------------------------------|--------------|---------------|---|
| | 1 | CGD | GND at control UNIT |
| | 2 | CSS | Stand By signal to control UNIT |
| | 1 | BUZ | BEEP TONE output |
| | 2 | GND | |
| | 1 | RL | TX of 13 V Relay control |
| | 2 | BUZ | BEEP Tone input |
| | 3 | GND | |
| IP | 1 | STS | KEY DOWN to SIDETONE ON |
| IP | 1 | SS | STAND BY |
| IP | 1 | 8 V | DC 8 V |
| IP | 1 | CWB | CW about 7 V |
| FILTER UNIT (X51-1320-00) | | | |
| | 1 | SW | ANT switch: ON = 50B |
| | 2 | 50B | 50 MHz BAND Relay Source |
| | 1 | RL | TX about 13 V Relay control |
| | 2 | FMB | FM: about 8 V |
| | 3 | RXB | RX: about 9 V |
| | 4 | PCL | Power control VR change about 0.4~3 V |
| | 5 | ALC | ALC LINE: NO ALC about 2.7 V |
| | 6 | 8 V | DC 8 V LINE |
| | 7 | TXB | TX about 8.8 V DC LINE |
| | 1 | RFM | RF meter control |
| | 2 | ALM | ALC meter control |
| | 1 | RA | RX ANT input |
| | 2 | E | GND |
| | 1 | ABB | AMATEUR BAND HAM = "H", ETC = "L" |
| | 2 | 50 | 50 MHz BAND information |
| | 3 | 28 | 28 BAND information |
| | 4 | 21 | 21 BAND information |
| | 5 | 7 | 7 BAND information |
| | 6 | 14 V | 14 V LINE |
| COAX | | IN | Power input from FINAL |
| COAX | | 50 | 50 MHz ANT output |
| COAX | | 750 | 7~50 MHz ANT output |
| IP | | TXB | TX about 8.8 V DC LINE |
| CONTROL UNIT (X53-1370-00) | | | |
| | 1 | MHS | 1 MHz STEP by touch to GND |
| | 2 | BD | 1 BAND or 1 MHz STEP DOWN by touch to GND |
| | 3 | BU | 1 BAND or 1 MHz STEP UP by touch to GND |
| | 1 | MU | MIC UP by GND |
| | 2 | MU | MIC DOWN by GND |
| | 1 | SS | STAND BY |
| | 2 | GND | GND |
| | 1 | GND | GND |
| | 2 | EN2 | Encoder input |
| | 3 | EN1 | |
| | 4 | 5 V | |

| Connector No. | Terminal No. | Terminal name | Function |
|---------------|--------------|---------------|---------------------------------------|
| | 1 | CWB | CW MODE information + B |
| | 2 | USB | USB MODE information + B |
| | 3 | LSB | LSB MODE information + B |
| | 1 | FMB | FMB MODE information + B |
| | 2 | AMB | AM MODE information + B |
| | 3 | CWB | CW MODE information + B |
| | 4 | SSB | SSB MODE information + B |
| | 1 | 7 A | 7 MHz BAND information operate "L" |
| | 2 | 21 A | 21 MHz BAND information operate "L" |
| | 3 | 28 A | 28 MHz BAND information operate "L" |
| | 4 | 50 A | 50 MHz BAND information operate "L" |
| | 1 | 05 A | 0.5 MHz BAND information operate "L" |
| | 2 | 2 A | 2 MHz BAND information operate "L" |
| | 3 | 4 A | 4 MHz BAND information operate "L" |
| | i | 12 A | 12 MHz BAND information operate "L" |
| | 5 | 10 A | 10 MHz BAND information operate "L" |
| | 6 | 8 A | 8 MHz BAND information operate "L" |
| | 7 | 16 A | 16 MHz BAND information operate "L" |
| | 1 | PS0 | VS-1 voice synthesizer address signal |
| | 2 | PS3 | VS-1 voice synthesizer address signal |
| | 3 | PB2 | VS-1 voice synthesizer address signal |
| | 4 | PS1 | VS-1 voice synthesizer address signal |
| | 5 | 5 V | 5 V output |
| | 6 | GND | GND |
| | 1 | 14 A | 14 V input |
| | 2 | AMF | AM Frequency shift control |
| | 1 | (NC) | — |
| | 2 | VSC | VS-1 operate by GND |
| | 1 | IFS | IF shift control voltage input |
| | 2 | RIT | RIT control input |
| | 1 | SBK | RX Blanking pulse input at PLL switch |
| | 2 | (GND) | — |
| | 1 | PS4 | VS-1 voice synthesizer address signal |
| | 2 | SR | Voice synthesizer start signal |
| | 3 | BY | Voice synthesizer ON = "H" |
| | 1 | dp | "d.p." data for display |
| | 2 | g | "g" data for display |
| | 1 | f | "f" data for display |
| | 2 | e | "e" data for display |
| | 3 | 5 V | 5 V output |
| | 1 | GND | GND |
| | 2 | P20 | expander control output |
| | 3 | P21 | |
| | 4 | P22 | |
| | 5 | P23 | |
| | 6 | PLG | clock output |
| | 7 | CS | chip selector output |
| | 1 | GS | GC-10 installation sencer |
| | 2 | GC | GC-10 installation sencer |
| | 1 | BZ | BEEP TONE control "L" = BEEP |
| | 2 | GND | GND |
| | 1 | 5 V | 5 V input |
| | 2 | 8 V | 8 V input |

TERMINAL FUNCTIONS

| Connector No. | Terminal No. | Terminal name | Function |
|-----------------------------------|--------------|---------------|---|
| | 1 | PB | PLL 8 V input |
| | 2 | PG | PLL GND |
| | 3 | CV | VCO control voltage output |
| | 1 | VC2 | VCO RF voltage input |
| | 2 | GND | GND |
| | 1 | CAR | carrier output |
| | 2 | GND | GND |
| | 1 | RL | TX about + 12 Relay control |
| | 2 | (GND) | — |
| | 1 | RC | RIT switch RIT works when toucher RC and RS |
| | 2 | RS | |
| | 1 | C2 | MATRIX input of KEY BOARD |
| | 2 | C3 | |
| | 3 | C4 | |
| | 4 | C5 | |
| | 5 | C1 | |
| | 1 | PGS | Program scan IND output |
| | 2 | MS | Memory scan IND output |
| | 3 | HLD | Hold IND output |
| | 1 | LOK | lock IND output |
| | 2 | STP | Step IND output |
| | 1 | D6 | MATRIX input of KEY BOARD |
| | 2 | D5 | |
| | 3 | D4 | |
| | 4 | D3 | |
| | 5 | D2 | |
| | 6 | D1 | |
| | 1 | 5 V | 5 V output |
| | 2 | GND | GND |
| | 1 | OAD | "ON AIR" display |
| | 2 | 5 V | 5 V output |
| DISPLAY UNIT (X54-1880-00) | | | |
| | 1 | 11 V | 11 V LINE (DC-DC CONVERTER SOURCE) |
| | 2 | GND | 0 V (DC-DC CONVERTER) |
| | 3 | -6 | -6 V LINE (DC-DC CONVERTER output) |
| | 1 | f | "f" data for display |
| | 2 | g | "g" data for display |
| | 1 | 5 V | 5 V LINE |
| | 2 | dp | "d.p." (dot point) data for display |
| | 3 | e | "e" data for display |
| | 1 | CS | chip select input |
| | 2 | PRG | clock input |
| | 3 | P23 | expander control output |
| | 4 | P22 | |
| | 5 | P21 | |
| | 6 | P20 | |
| | 7 | GND | GND |

TS-670

OPTION (GC-10)

GC-10 CIRCUIT DESCRIPTION

The GC-10 is an optional unit to be attached to the TS-670 to permit reception of 0.5 to 30 MHz (excluding certain frequencies).

The GC-10 consists of RF amp and 6 sets of BPFs, and six VCOs.

The RF signal is fed from the TS-670 via the RF attenuator, then each band is selected by switching diodes D1 to D12 (IS2588) and amplified by RF amp Q1 (3SK74), then fed

through buffer amp Q2 before being input to the reception mixer of the TS-670.

Excluding the 0.5 to 1.8 MHz band, the medium frequency trap for other bands is inserted at the input.

The VCO output for each band is fed through buffer amps Q3 and Q4, then output to the reception mixer of the TS-670.

D31 is a circuit which permits the control unit to detect that the GC-10 is attached to the TS-670.

ADJUSTMENT

| Item | Condition | Measurement | | | | Adjustment | | Specification | Remarks | |
|----------------------|--|----------------------|------|--------------|------|------------|-------------------------------|---------------|-------------|---------|
| | | Test equipment | Unit | Terminal | Unit | Parts | Method | | | |
| 1. VCO adjustment | Voltage adjustment MODE: FM | DC VM | GC | CV | GC | | | | | |
| | | | | | | | | L34 | 6.0V | |
| | | | | | | | | | 1.8 ~ 2.8V | Confirm |
| | | | | | | | | L36 | 6.5V | |
| | | | | | | | | | 1.8V ± 0.5V | Confirm |
| | | | | | | | | L38 | 6.5V | |
| | | | | | | | | | 1.9V ± 0.5V | Confirm |
| | | | | | | | | L40 | 6.5V | |
| | | | | | | | | | 1.7V ± 0.5V | Confirm |
| | | | | | | | | | 2V ± 0.5V | |
| | | | | | | | | | 5.7V ± 0.5V | Confirm |
| | | | | | | | | L43 | 6.5V | |
| | | | | | | | | L45 | 6.5V | |
| | 1 ~ 1.9V | Confirm | | | | | | | | |
| 2. RX BPF adjustment | (1) Display: 1MHz (0.5 ~ 1.799MHz) MODE: FM •Connect the sweep output to RF U 2 connector. •Connect the detector to the RF U D3 cathode. | SWEEP SCOPE DETECTOR | RF | D3 (cathode) | GC | L5,6,7 | Adjust as shown on the right. | | | |
| | (2) Display: 2MHz (1.8 ~ 3.999MHz) | | | | | | | L8,9,10 | | |
| | (3) Display: 5MHz (4 ~ 6.599MHz) | | | | | | | L11,12,13 | | |

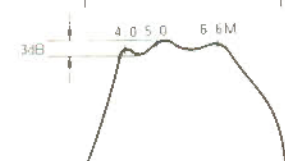
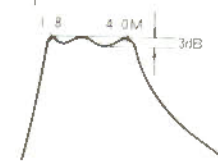
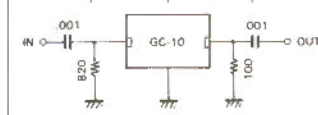
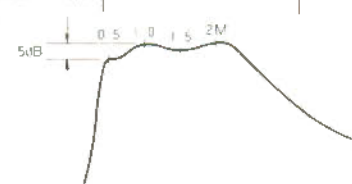

OPTION (GC-10)

ADJUSTMENT

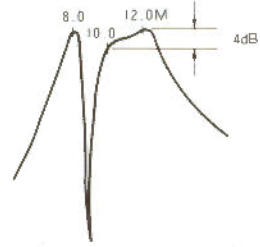
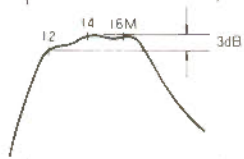
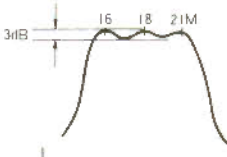
| Item | Condition | Measurement | | | | Adjustment | | Specification | Remarks |
|----------------------|---------------------------------------|---------------------------------|------|-----------------|------|---------------|---|---|---------|
| | | Test equipment | Unit | Terminal | Unit | Parts | Method | | |
| 3. RX BPF adjustment | (4) Display: 10MHz (8 ~ 11.999MHz) | SWEEP SCOPE DETECT- OR | RF | D3 (cathode) | GC | L14, 15 16 | |  | |
| | L17, 18 19 | | | | | |  | | |
| | L20, 21 22 | | | | | |  | | |

GC-10 SPECIFICATIONS

- Reception frequency range : 500 kHz ~ 30 MHz
(Except around 8.83MHz)
- Image ratio : 40 dB or more*
- IF disturbance ratio : 40 dB or more*
* Except 7.0 ~ 7.1 MHz, 21.0 ~ 21.45MHz and 28 ~ 29.7 MHz
- Sensitivity

| Frequency | Mode | SSB, CW (10 dB S/N) | AM (10 dB S/N) |
|-----------------|--------------|-------------------------------------|------------------------------------|
| | 0.5 ~ 1.8MHz | | 6 dB μ (2 μ V) or less |
| 1.8 ~ 7MHz | | -6 dB μ (0.5 μ V) or less | 12 dB μ (4 μ V) or less |
| * 7 ~ 7.1MHz | | -12 dB μ (0.25 μ V) or less | 6 dB μ (2 μ V) or less |
| 7.1 ~ 8.3MHz | | -6 dB μ (0.5 μ V) or less | 12 dB μ (4 μ V) or less |
| 9.5 ~ 21MHz | | -6 dB μ (0.5 μ V) or less | 12 dB μ (4 μ V) or less |
| * 21 ~ 21.45MHz | | -12 dB μ (0.25 μ V) or less | 6 dB μ (2 μ V) or less |
| 21.45 ~ 23MHz | | -6 dB μ (0.5 μ V) or less | 12 dB μ (4 μ V) or less |
| 23 ~ 24.8MHz | | 4 dB μ (1.6 μ V) or less | 22 dB μ (12.5 μ V) or less |
| * 24.8 ~ 28MHz | | -6 dB μ (0.5 μ V) or less | 12 dB μ (4 μ V) or less |
| 28 ~ 29.7MHz | | -12 dB μ (0.25 μ V) or less | 6 dB μ (2 μ V) or less |
| 29.7 ~ 30MHz | | -6 dB μ (0.5 μ V) or less | 12 dB μ (4 μ V) or less |

* TS-670

- Dimensions : 71 mm width
23 mm height
135 mm depth
- Weight : Approx. 100 g

| Parts No. | Re- marks | Description | Q'ty | Ref No. |
|---------------------------------|--------------|---------------------------|------|--|
| GC-10 | | | | |
| B50-4140-00 | | OPERATING MANUAL | 1 | |
| H01-4567-03 | | CARTON (INSIDE) | 1 | |
| H03-2193-04 | | PACKING CASE OUTSIDE | 110 | |
| H12-1365-04 | | BUFFER | 1 | |
| J61-0408-05 | | VINYL TIE | 3 | |
| N87-3012-46 | | TAPPING SCREW | 6 | |
| X44-1610-00 | | GC UNIT | 1 | |
| GC-10 UNIT (X44-1610-00) | | | | |
| CC45RH1H050C | | CERAMIC 5P 50V | 1 | C , 38 |
| CC45TH1H060D | | CERAMIC 6P 50V | 1 | C , 33 |
| CC45TH1H070D | | CERAMIC 7P 50V | 1 | C , 60 |
| CC45SL1H820J | | CERAMIC 82P 50V | 2 | C , 22, 24 |
| CC45RH1H100D | | CERAMIC 10P 50V | 3 | C , 30, 32, 42 |
| CC45SL1H101J | | CERAMIC 100P 50V | 2 | C , 12, 16 |
| CC45RH1H120J | | CERAMIC 12P 50V | 2 | C , 37, 45 |
| CC45TH1H150J | | CERAMIC 15P 50V | 1 | C , 46 |
| CC45SL1H151J | | CERAMIC 150P 50V | 1 | C , 23 |
| CC45RH1H180J | | CERAMIC 18P 50V | 1 | C , 41 |
| CC45RH1H220J | | CERAMIC 22P 50V | 1 | C , 79 |
| CC45UJ1H330J | | CERAMIC 33P 50V | 1 | C , 80 |
| CC45RH1H470J | | CERAMIC 47P 50V | 1 | C , 29 |
| CC45RH1H560J | | CERAMIC 56P 50V | 1 | C , 31 |
| CC45UJ1H100D | | CERAMIC 10P 50V | 2 | C , 56, 61 |
| CC45UJ1H150J | | CERAMIC 15P 50V | 4 | C , 47, 48, 57, 62 |
| CC45UJ1H470J | | CERAMIC 47P 50V | 3 | C , 44, 52, 59 |
| CE04W1A470M | | ELECTRO 47 10V | 7 | C , 27, 34, 36, 40, 49, 55, 64 |
| CK45F1H103Z | | CERAMIC 0.01 50V | 3 | C , 5, 7, 26 |
| CQ92M1H122K | | MYLAR 1200P 50V | 1 | C , 4 |
| CQ92M1H272K | | MYLAR 2700P 50V | 1 | C , 3 |
| CQ92M1H472K | | MYLAR 4700P 50V | 1 | C , 2 |
| CQ92M1H682K | | MYLAR 6800P 50V | 1 | C , 1 |
| C91-0117-05 | | CERAMIC CAP 0.01 | 12 | C , 25, 28, 33, 35, 39, 43, 50, 51, 54, 58, 63, 65 |
| C91-1008-05 | | CERAMIC 0.022 | 6 | C , 68, 70, 72, 74, 76, 77 |
| C91-0119-05 | | CERAMIC 0.047 25V | 11 | C , 8, 9, 10, 15, 66, 67, 69, 71, 73, 75, 78 |
| E31-2170-05 | | JUMPER WIRE | 13 | |
| E40-0273-05 | | MINI CONNECTOR 2P | 4 | |
| E40-0573-05 | | MINI CONNECTOR 5P | 1 | |
| E40-0773-05 | | PIN ASS'Y 7P | 1 | |
| F11-0867-04 | | SHIELDING CASE | 1 | |
| ITT310TE | | VARI-CAP DIODE | 8 | D , 15, 17, 18, 20, 21, 23, 27, 29 |
| J31-0502-04 | | COLLAR | 6 | |
| J42-0428-05 | | BUSHING | 6 | |
| L32-0195-05 | | OSCILLATING COIL | 2 | L , 40, 43 |
| L32-0197-05 | | OSCILLATING COIL 21.28MHZ | 1 | L , 45 |
| L32-0668-05 | N | OSCILLATING COIL | 1 | L , 34 |
| L32-0669-05 | N | OSCILLATING COIL | 1 | L , 36 |
| L32-0670-05 | N | OSCILLATING COIL | 1 | L , 38 |
| L34-3106-05 | N | BPF COIL 05A | 1 | L , 5 |
| L34-3107-05 | N | BPF COIL 05B | 1 | L , 6 |
| L34-3108-05 | N | BPF COIL 05C | 1 | L , 7 |
| L34-3109-05 | N | BPF COIL 2A | 1 | L , 8 |
| L34-3110-05 | N | BPF COIL 2B | 1 | L , 9 |
| L34-3111-05 | N | BPF COIL 2C | 1 | L , 10 |
| L34-3112-05 | N | BPF COIL 4A | 1 | L , 11 |
| L34-3113-05 | N | BPF COIL 4B | 1 | L , 12 |
| L34-3114-05 | N | BPF COIL 4C | 1 | L , 13 |
| L34-3115-05 | N | BPF COIL 8A | 1 | L , 14 |

| Parts No. | Re- marks | Description | Q'ty | Ref No. |
|-------------|--------------|----------------------------|------|---|
| L34-3116-05 | N | BPF COIL 8B | 1 | L , 15 |
| L34-3117-05 | N | BPF COIL 8C | 1 | L , 16 |
| L34-3118-05 | N | BPF COIL 12A | 1 | L , 17 |
| L34-3119-05 | N | BPF COIL 123B | 1 | L , 18 |
| L34-3120-05 | N | BPF COIL 12C | 1 | L , 19 |
| L34-3121-05 | N | BPF COIL 16A | 1 | L , 20 |
| L34-3122-05 | N | BPF COIL 16B | 1 | L , 21 |
| L34-3123-05 | N | BPF COIL 16C | 1 | L , 22 |
| L40-3392-02 | | INDUCTOR 3.3 UH | 1 | L , 1 |
| L40-1001-02 | | INDUCTOR 10 UH | 3 | L , 2, 3, 4 |
| L40-1511-03 | | INDUCTOR 150 UH | 6 | L , 33, 35, 37, 39, 42, 44 |
| L40-4711-03 | | INDUCTOR 470 UH | 1 | L , 24 |
| L40-8211-07 | N | INDUCTOR 820 UH | 1 | L , 23 |
| L40-3982-14 | | INDUCTOR 0.39UH | 2 | L , 30, 31 |
| L40-1011-14 | | INDUCTOR 100 UH | 6 | L , 27, 32, 41, 47, 48, 49 |
| L40-1511-14 | | INDUCTOR 150 UH | 1 | L , 46 |
| R90-0576-05 | N | CAPACITOR BLOCK 0.01UF X 7 | 1 | 1B , 1 |
| R90-0577-05 | N | DIODE BLOCK 1S1555 X 7 | 1 | 1B , 2 |
| R92-0150-05 | | JUMPER WIRE | 7 | |
| UPA80C | | IC | 1 | Q , 11 |
| 1S1555 | | DIODE | 4 | D , 13, 14, 26, 31 |
| 1S1587 | | DIODE | 6 | D , 16, 19, 22, 25, 28, 30 |
| 1S2588 | | DIODE | 13 | D , 1, 2, 3, 4, 5, 6, 7, 8, 9, 10, 11, 12, 24 |
| 2SC1923(D) | | TR | 1 | Q , 3 |
| 2SC1959(Y) | | TR | 1 | Q , 4 |
| 2SC2458(Y) | | TR OR 2SC2603(E) | 7 | Q , 2, 5, 6, 7, 8, 9, 10 |
| 3SK74(L) | | FET | 1 | Q , 1 |

TS-670 OPTION (GC-10)

OPTION (GC-10)

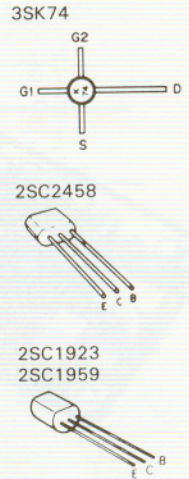
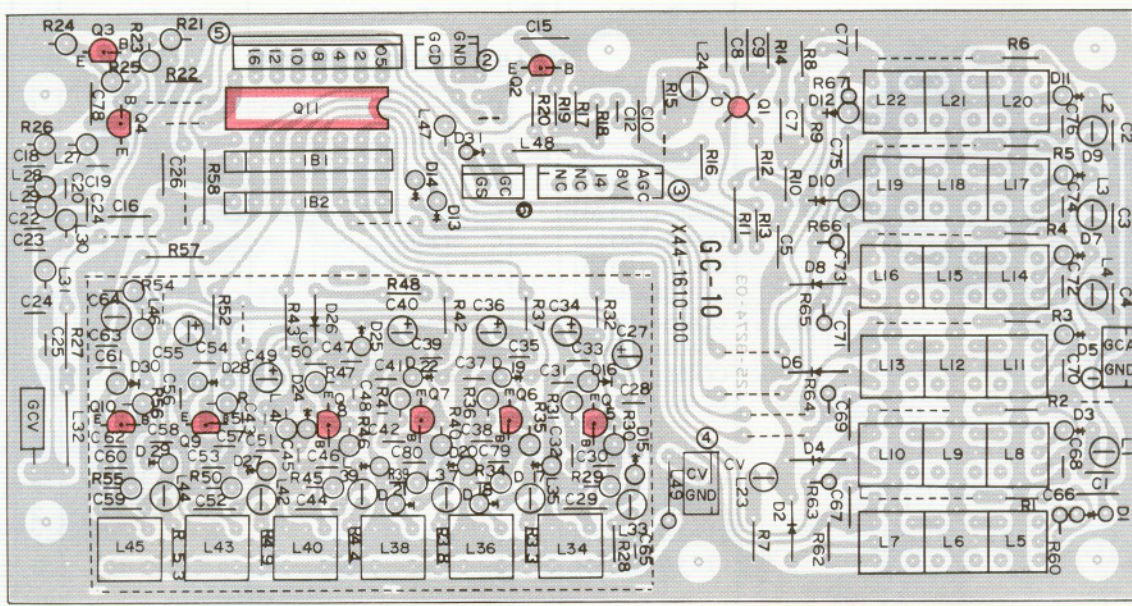

Q1 : 3SK74(L) Q2, 5 - 10 : 2SC2458(Y) Q3 : 2SC1923(O) Q4 : 2SC1959(Y) Q11 : μ PC80C D1 - 12, 24 : 1S2588 D13, 14, 26, 31 : 1S1555 D15, 17, 18, 20, 21, 23, 27, 29 : 1TT310TE D16, 19, 22, 25, 28, 30 : 1S1587

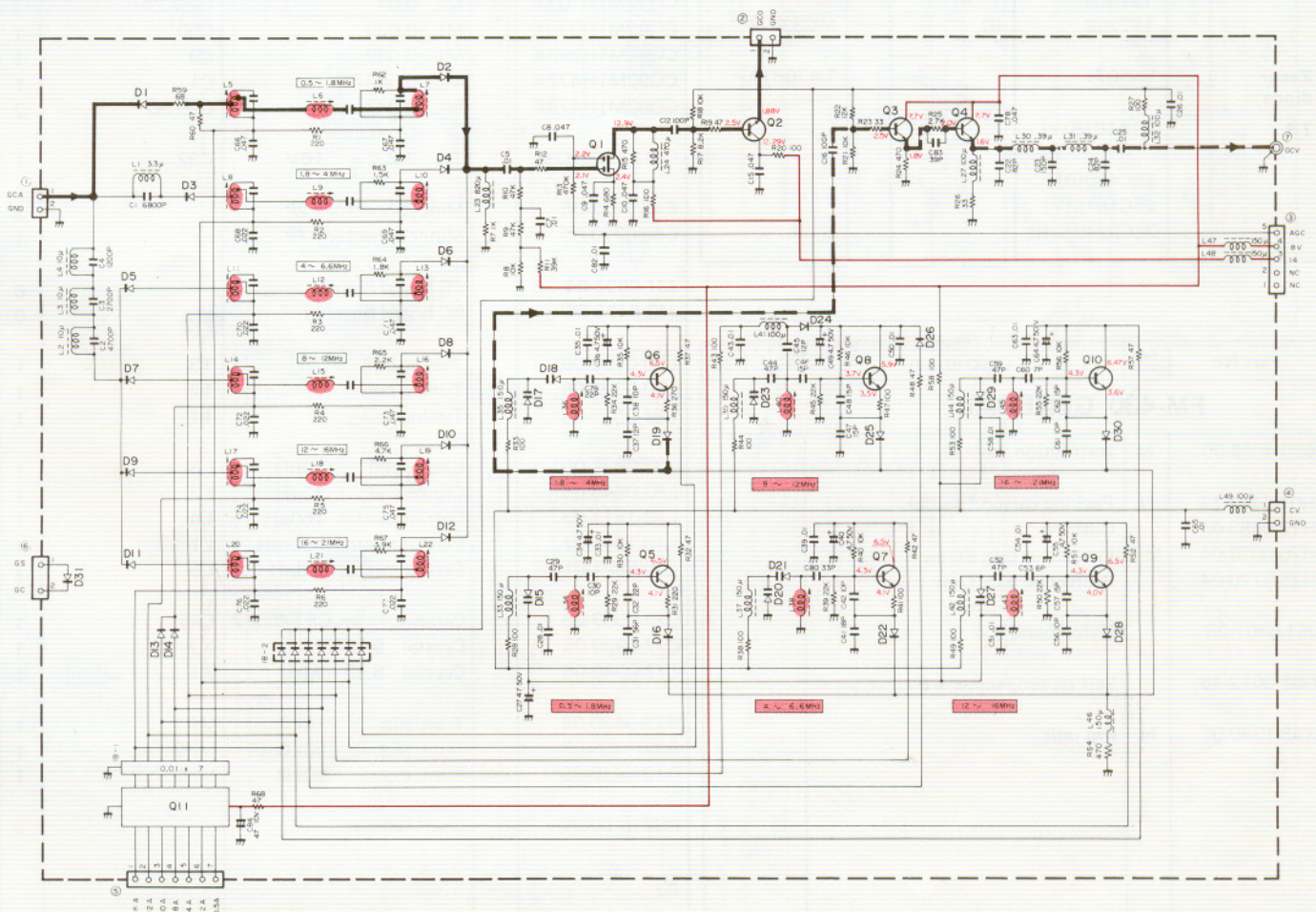

TS-670

OPTION (FM-430)

OUTSIDE VIEW

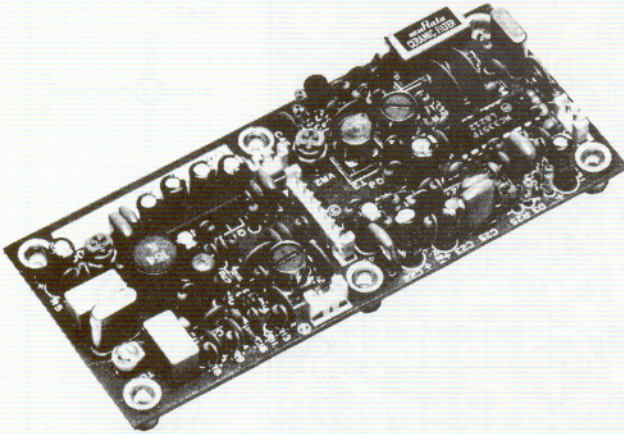

PARTS LIST

SEMICONDUCTOR

N : New parts

| Item | Re- marks | Name | Item | Re- marks | Name |
|-------------|--------------|---------------------------|------------|--------------|-----------|
| Diode | | 1N60 | FET | | 3SK73(GR) |
| | | 1S1555 | | | |
| | | 1S2208 | | IC | |
| Zener diode | | WZ-071 | | | TA7061AP |
| | TR | | 2SA1015(Y) | | |
| | | 2SC460(B) | | | |
| | | 2SC1815(Y) 2SC2240(GR) | | | |

| Part No. | Re- marks | Description | Ref. No. |
|-----------------------|--------------|-------------------------|----------|
| FM-430 GENERAL | | | |
| B50-4029-00 | N | Instruction manual | |
| H01-4471-13 | N | Packing carton (inside) | |
| H12-0483-04 | | Cushion | |
| H25-0029-04 | | Protective bag, Screw | |
| H25-0120-04 | | Protective bag, Unit | |
| J61-0401-05 | | Nylon band x 4 | |
| N87-3012-46 | | Self tapping screw x 6 | |
| X48-1340-01 | N | FM unit | |

| Part No. | Re- marks | Description | Ref. No. | Q'ty |
|------------------------------|--------------|-------------------------|------------------------------|------|
| FM UNIT (X48-1340-01) | | | | |
| C05-0031-15 | | Ceramic trimmer 10P | TC1 | 1 |
| CC45SL1H050C | C | 5P | C15 | 1 |
| CC45SL1H101J | C | 100P | C29 | 1 |
| CC45SL1H120J | C | 12P | C40 | 1 |
| CC45SL1H121J | C | 120P | C34 | 1 |
| CC45SL1H150J | C | 15P | C51 | 1 |
| CC45SL1H220J | C | 22P | C16,41 | 2 |
| CC45SL1H221J | C | 220P | C12,14 | 2 |
| CC45SL1H560J | C | 56P | C35 | 1 |
| CC45SL1H680J | C | 68P | C27,28 | 2 |
| CC45UJ1H070D | C | 7P | C11 | 1 |
| CE04W1A101M | E | 100 10V | C37 | 1 |
| CE04W1A220M | E | 22 10V | C4,23 | 2 |
| CE04W1A470M | E | 47 10V | C3,6 | 2 |
| CE04W1E4R7M | E | 4.7 25V | C49 | 1 |
| CE04W1H010M | E | 1 50V | C5,8,10,22,31 | 5 |
| CK45B1H102K | C | 0.001 | C26,45 | 2 |
| CK45B1H152K | C | 0.0015 | C42 | 1 |
| CK45F1H103Z | C | 0.01 | C13,17,20,21,33, 36,43,46 | 8 |
| CK45F1H223Z | C | 0.022 | C18,19,44,48 | 4 |
| CK45F1H473Z | C | 0.047 | C38,39 | 2 |
| CQ92M1H103K | ML | 0.01 | C2,7,24 | 3 |
| CQ92M1H333K | ML | 0.033 | C50 | 1 |
| CQ92M1H393K | ML | 0.039 | C9 | 1 |
| CQ92M1H472K | ML | 0.0047 | C1 | 1 |
| CQ92M1H473K | ML | 0.047 | C25,30 | 2 |
| CS15E1C2R2M | T | 2.2 16V | C32 | 1 |
| E40-0273-05 | | Mini connector 2P | | 3 |
| E40-0773-05 | | Mini connector 7P | | 1 |
| J31-0502-04 | | PC board collar | | 6 |
| J42-0428-05 | | PC board bushing | | 6 |
| L30-0199-06 | | Tuning coil | T3 | 1 |
| L30-0503-05 | | Tuning coil | T2 | 1 |
| L34-0535-05 | | Tuning coil | T1 | 1 |
| L33-0639-05 | | Choke coil 10μH | L3 | 1 |
| L33-0640-05 | | Choke coil 12μH | L2 | 1 |
| L40-1511-03 | | Ferri-inductor 150μH | L4 | 1 |
| L40-1541-27 | | Ferri-inductor 150mH | L1 | 1 |
| L40-6891-01 | | Ferri-inductor 6.8μH | L5 | 1 |
| C72-0309-06 | | Ceramic filter CFT455F2 | CF1 | 1 |
| C77-0939-05 | | Crystal 9.2865MHz | X2 | 1 |
| C77-0940-05 | | Crystal 8.8315MHz | X1 | 1 |
| R12-3430-05 | | Trim. pot. 10kΩ(B) | VR1 | 1 |
| R12-4408-05 | | Trim. pot. 50kΩ(B) | VR2 | 1 |
| R12-4410-05 | | Trim. pot. 50kΩ | VR3 | 1 |
| R92-0150-05 | | Short jumper | | 2 |

OPTION (FM-430)

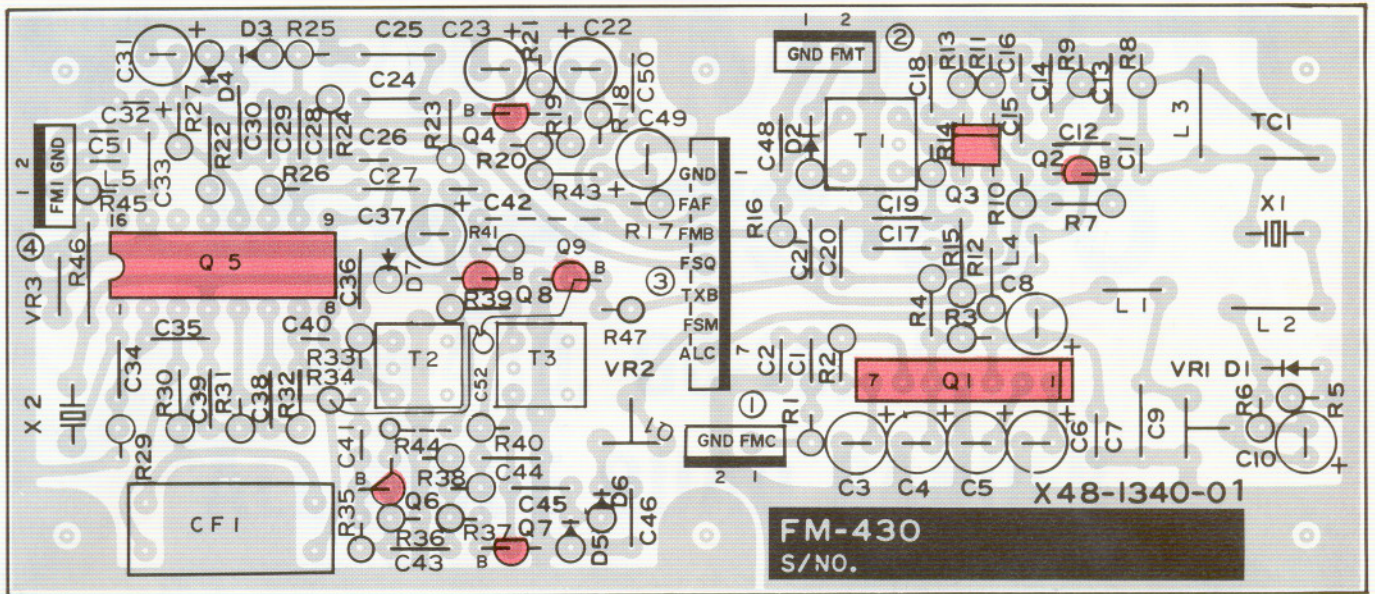

FM UNIT (X48-1340-01)

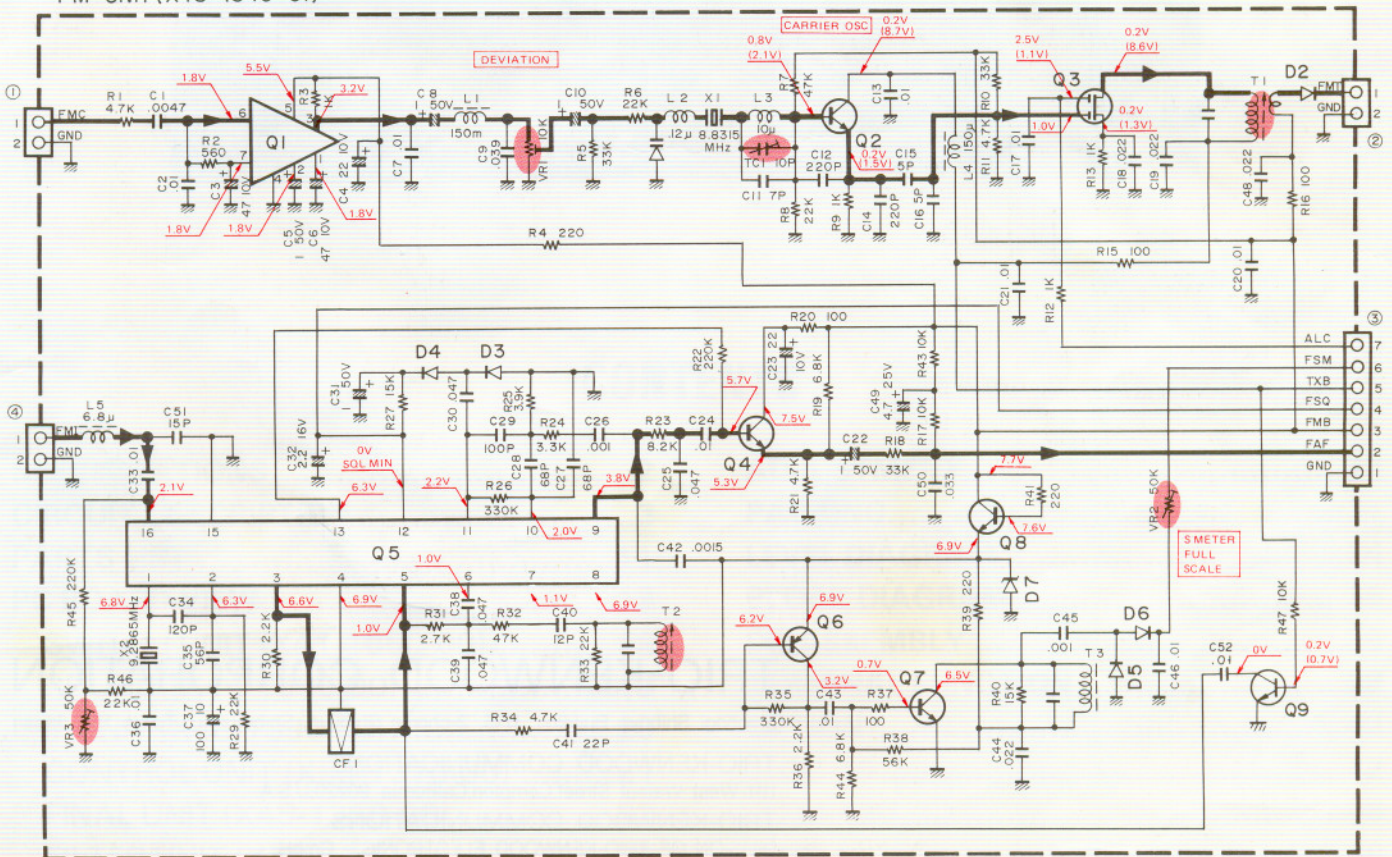

2SA1015 2SC1815
2SC2240

2SC460

TA7061AP

Q1 : TA7061AP
Q2 : 2SC460(B)
Q3 : 3SK73(GR)
Q4 : 2SC2240(GR)

Q5 : MC3357P
Q6 : 2SA1015(Y)
Q7 ~ 9 : 2SC1815(Y)

D1 : IS2208
D2 : IS1555
D3 ~ 6 : IN60
D7 : MTZ7.5JA

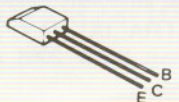
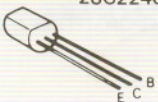

TS-670

OPTION (VS-1 Voice synthesizer unit)

SPECIFICATIONS

Dimensions: W 70mm
H 15mm
D 35mm

Weight: 20g

OUTSIDE VIEW

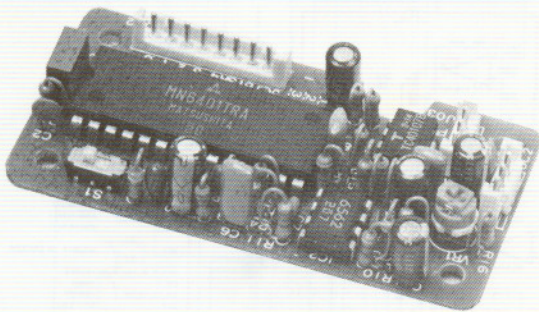

TALK SPEED SELECTION

Speed is factory set at "standard" talk speed. Three different speeds can be selected.

Note: When placing the jumper, solder carefully.

| Jumper place | Speed | | |
|--------------|------------|--------------------|--------------------|
| | Std. speed | 30% more than Std. | 60% more than Std. |
| 1 | X | X | ○ |
| 2 | X | X | ○ |
| 3 | X | ○ | X |

Symbol ○, denotes the place in which a jumper wire is placed.

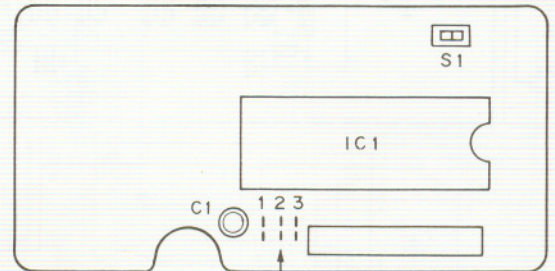

The place which a jumper wire to be placed.

PARTS LIST

| Part No. | Re- marks | Description | Ref. No. |
|--------------|--------------|-------------------------|----------|
| B50-4035-00 | N | Instruction manual | |
| CC45SL1H121J | C | 120P x 2 | C2,3 |
| CE04W1A470M | E | 47 10V | C1,14,15 |
| CE04W1C100M | E | 10 16V | C11 |
| CE04W1HR22M | E | 0.22 50V | C12 |
| CK45B1H221K | C | 220P x 2 | C7,10 |
| CQ92M1H332K | ML | 0.0033 x 3 | C6,8,9 |
| CS15E1E010M | T | 1 25V | C4 |
| CS15E1V0R1M | T | 0.1 35V | C5 |
| C91-0131-05 | C | 0.01 (SP) | C13 |
| E40-0273-05 | Δ | Mini connector 2P W | M |
| E40-0373-05 | Δ | Mini connector 3P W | M |
| E40-0373-05 | Δ | Mini connector x 2 3P | T |
| E40-0873-05 | Δ | Mini connector 8P W | |
| E40-5083-45 | N | Mini connector 3P B | |
| H01-4481-03 | NΔ | Packing carton (inside) | M |
| H01-4501-03 | NΔ | Packing carton (inside) | T |
| H25-0029-04 | | Protective bag x 2 | |
| L78-0006-05 | N | Ceramic OSC | X1 |
| N89-3006-46 | | Tapping screw x 4 | |
| R12-4408-05 | | Trim. pot. 50kΩ | VR1 |
| S31-1411-05 | N | Slide switch | S1 |
| AN6562 | N | IC | IC2 |
| MN6401TRA | N | IC | IC1 |
| TC40107BP | N | IC | IC3 |

PC BOARD VIEW

Component side view

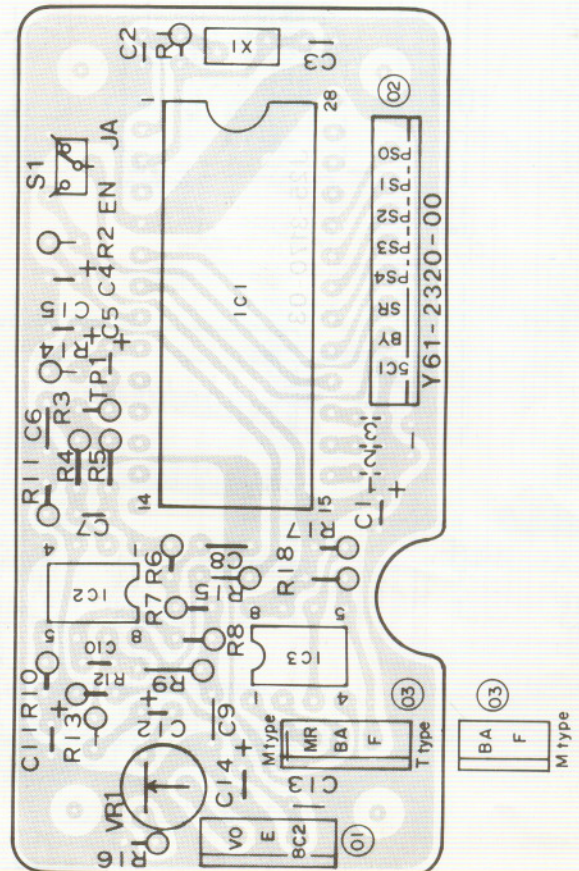

OPTION (VS-1)

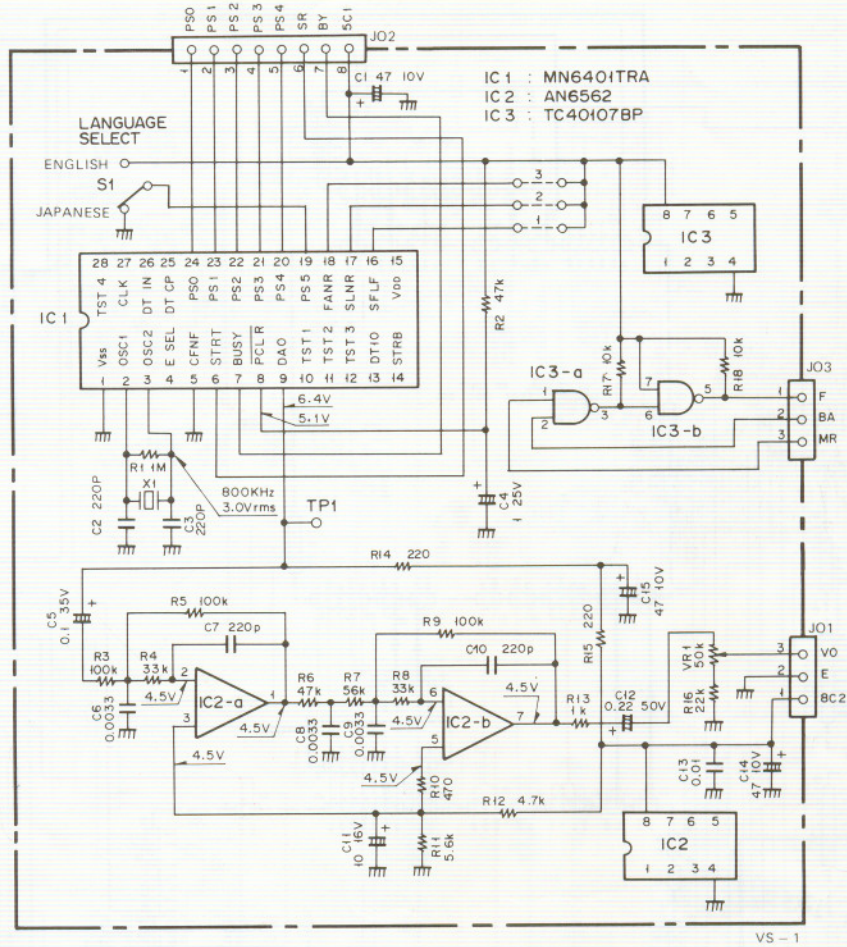

VS-1

- 2SA1015
- 2SC1923
- 2SC1775
- 2SC1959
- 2SC1815
- 2SC2240

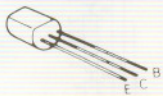

- 2SC2026
- 2SC2407
- 2SC2671

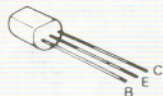

- 2SC2538

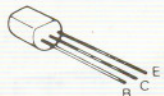

- 2SA1012

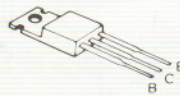

- 2SC2458
- 2SC2603

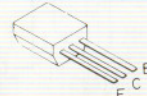

- 2SC496

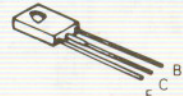

- 2SC460

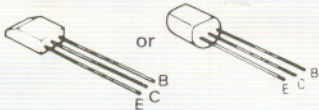

- 2SK30A
- 2SK125

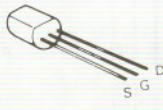

- 2SK192A

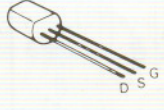

- 2SC2406TS

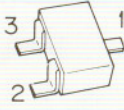

- 3SK74
- 3SK97
- 3SK114

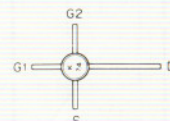

- NJM78L06A

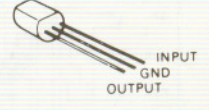

RF UNIT (X44-1580-00)

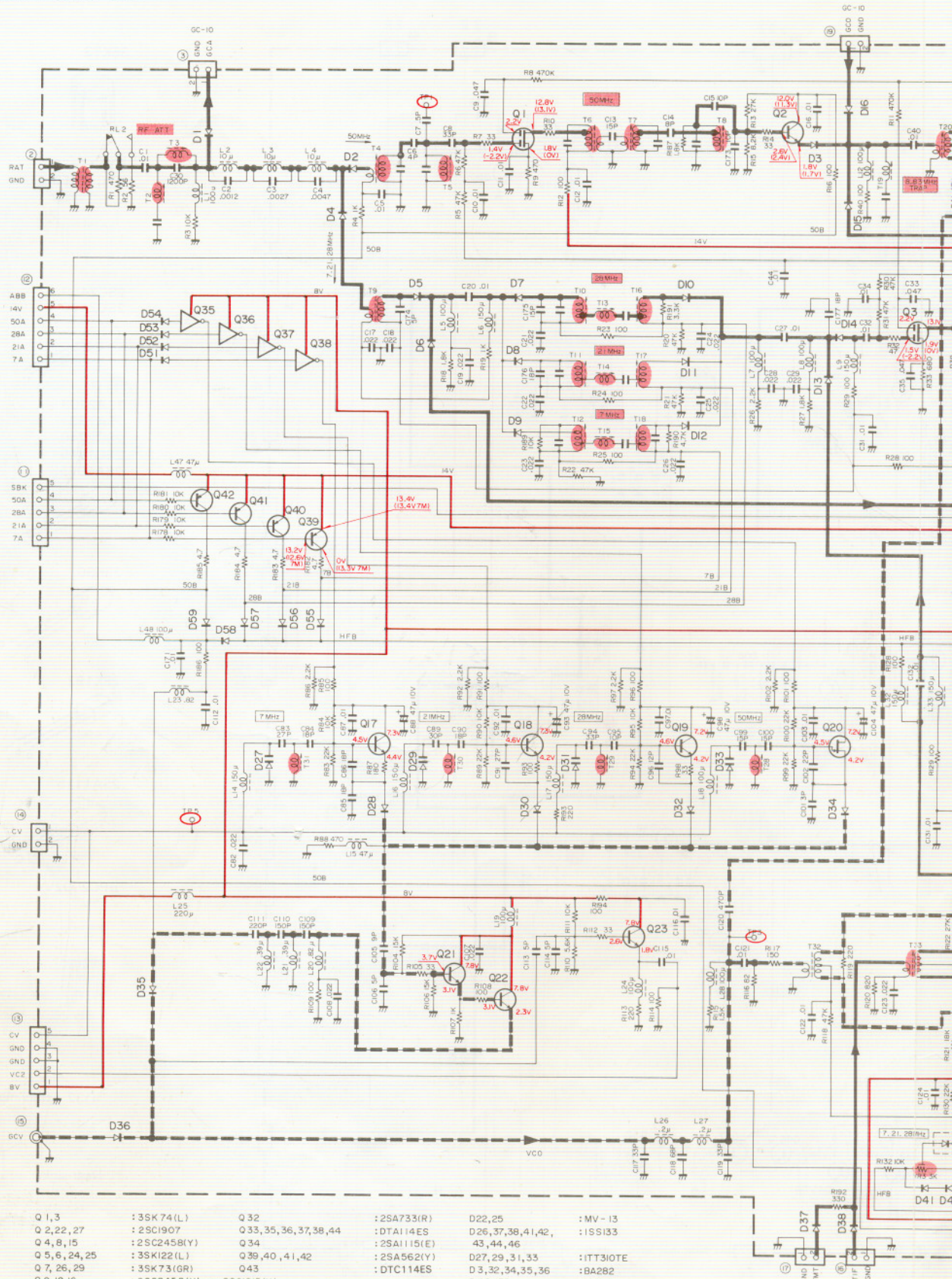

| | | | | | |
|----------------|------------------------------|--------------------------------|--------------|----------------------|-----------|
| Q 1, 3 | : 3SK 74(L) | Q 32 | : 2SA 733(R) | D22, 25 | : MV - 13 |
| Q 2, 22, 27 | : 2SC 1907 | Q33, 35, 36, 37, 38, 44 | : DTA 114 ES | D26, 37, 38, 41, 42, | : 1S133 |
| Q 4, 8, 15 | : 2SC 245B(Y) | Q 34 | : 2SA 115(E) | 43, 44, 46 | |
| Q 5, 6, 24, 25 | : 3SK 122(L) | Q39, 40, 41, 42 | : 2SA 562(Y) | D27, 29, 31, 33 | : 1TT30TE |
| Q 7, 26, 29 | : 3SK 73(GR) | Q 43 | : DTC 114 ES | D 3, 32, 34, 35, 36 | : MC921 |
| Q 9, 10, 16 | : 2SC 245B(Y) or 2SC 1815(Y) | | | D 40, 50 | : MV-203 |
| Q 11 | : 2SK 192(Y) | | | D 48 | : 1S1555 |
| Q12, 13, 14 | : 2SC 460 9) | D1, 2, 4, 5, 7, 10, 14 | : 1S2588 | D51, 52, 53, 54, 55, | |
| Q17, 18, 19 | : 2SC 2787(L) | D 6, 8, 9, 11, 12, 13, 15, 16, | : 1S15 87 | 56, 57, 58, 59 | |
| Q20 | : 2SK 192A(GR) | 17, 18, 19, 20, 28, 30, 45, 47 | | | |
| Q 21 | : 2SC 2347 | D 21, 23, 24 | : 1N60 | | |
| Q23 | : 2SC 1923(O) | | | | |
| Q28, 30, 31 | : 2SC 2086 | | | | |

- 3SK 74
- 3SK 122
- 2SC 1907
- 2SC 1815
- 2SC 2787
- 2SC 247
- 2SC 1923
- 2SA 733



SCHEMATIC DIAGRAM TS-670

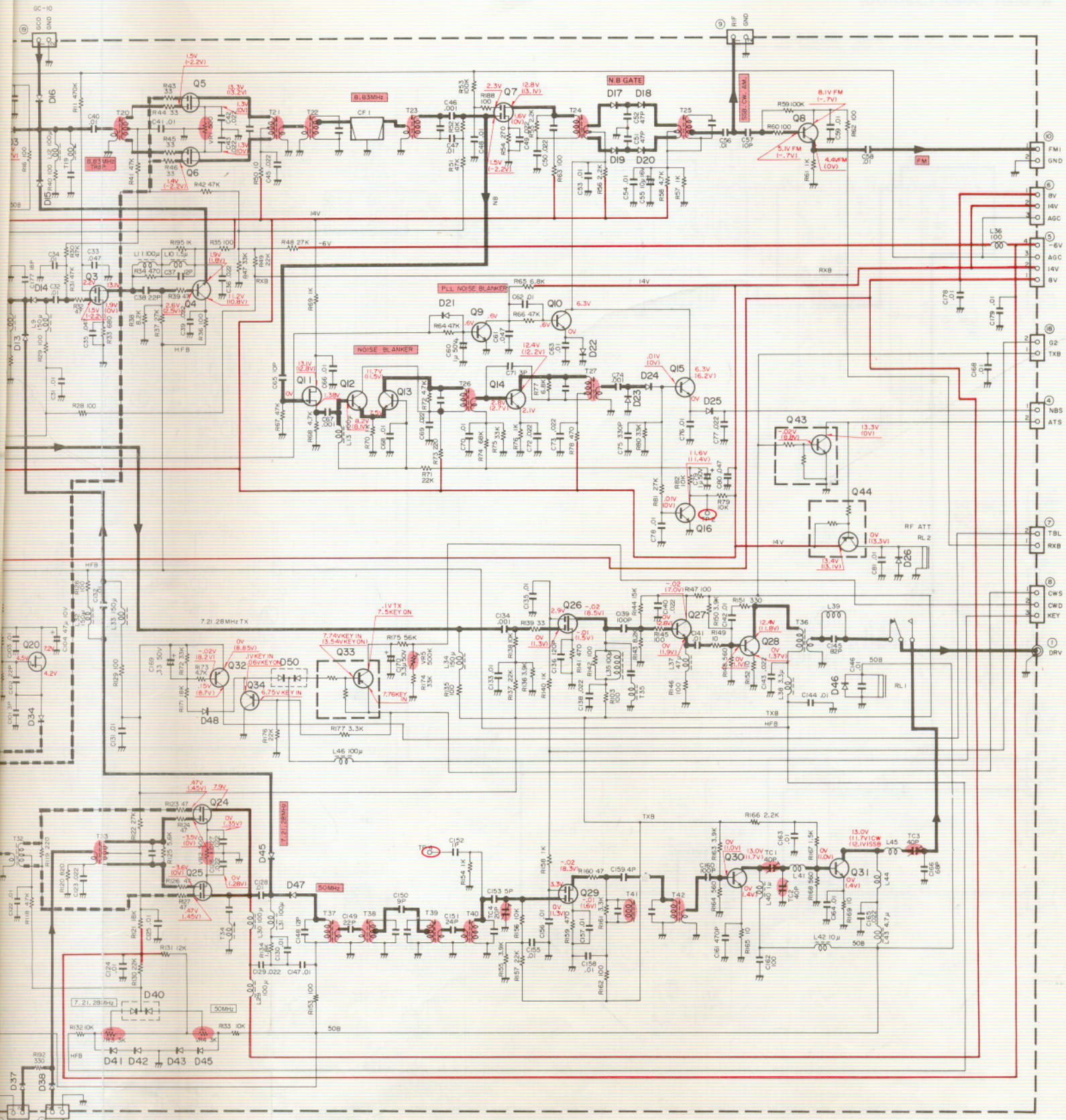

- 2SC1907
- 2SC1815
- 2SC2787
- 2SC2347
- 2SC1923
- 2SA733
- 2SC2458
- 3SK73
- 2SK192
- 2SC460
- 2SC2086
- 2SA1115
- 2SA562
- DTA114ES
- DTC114ES

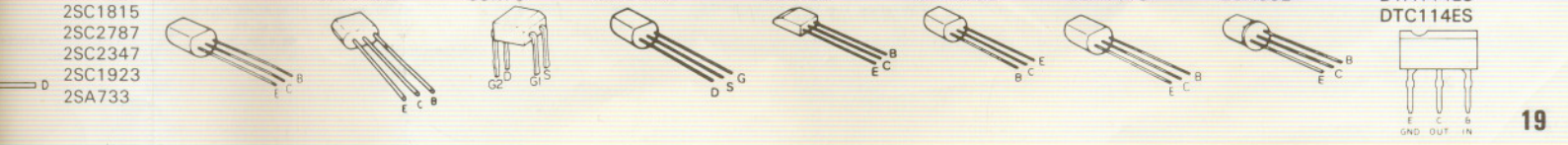

TS-670 SCHEMATIC DIAGRAM

IF UNIT (X48-1390-00)

IF UNIT (X48-1390-00)

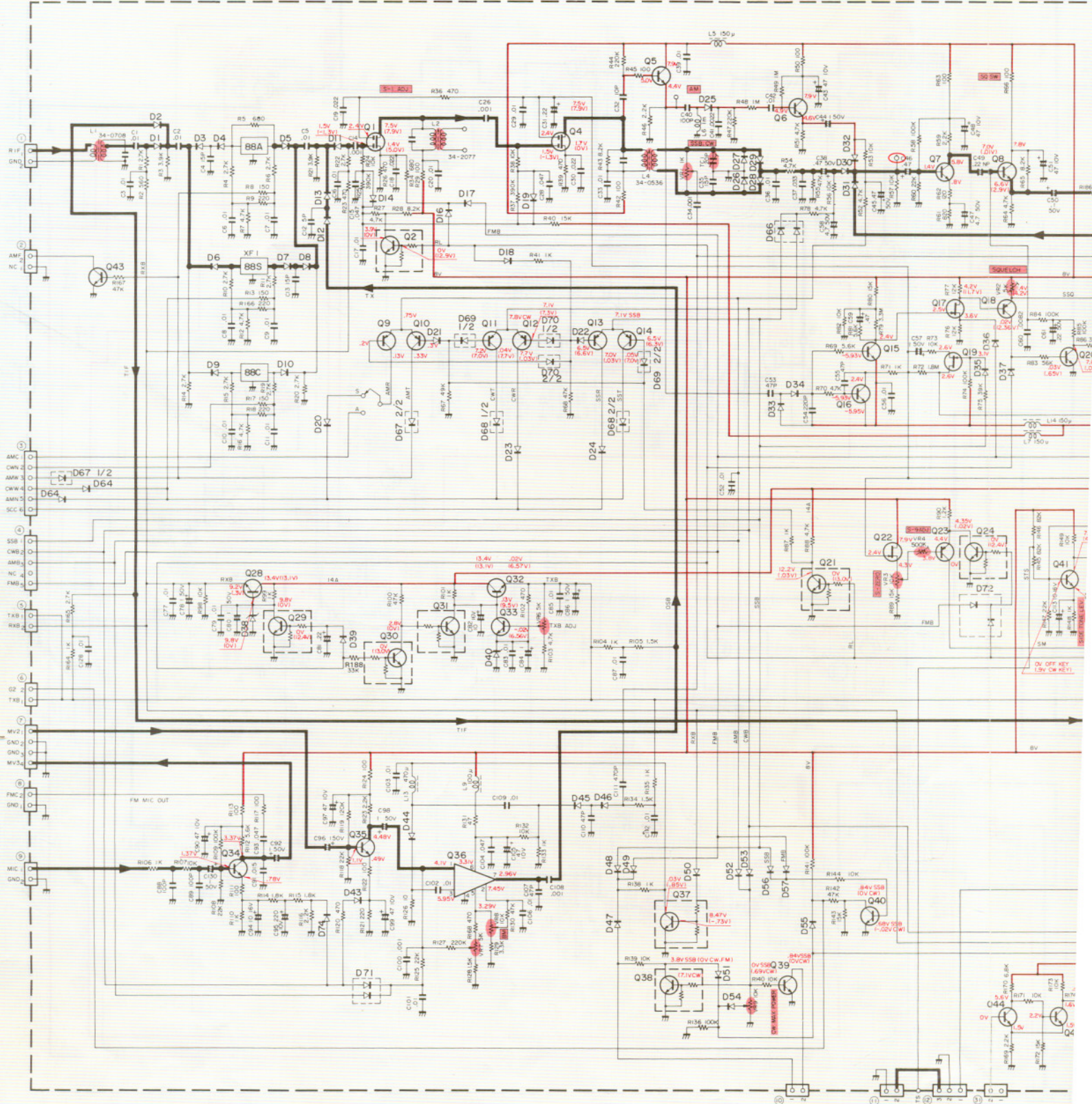

| | | | | | | | | | |
|------------------|--------|-------------------------------------|----------|---------------------------------|----------|-----|------------|---------------------------------|-----------------|
| D25 ~ 29, 33, 34 | 1N60 | D1, 2, 12, 14, 16, 17, 18, 21 ~ 24, | : 1S1555 | D11, 13, 19, 20, 35, 47, 48, 50 | : 1S133 | | | | |
| D3 ~ 8 | 1S1007 | 30, 31, 32, 36, 37, 39, 43, 49 | | D45 | : 1S2588 | | | | |
| D66 ~ 72 | MC921 | 51 ~ 58, 64, 65, 74 | | D44 | : MI204 | D73 | : MT24.3JA | Q23 | : 2SA115(E) or |
| D4, 6, 9, 10 | 1S1587 | | | D61 | : VO6B | D40 | : MT26.2JA | Q9 14, 18 | : 2SA733(R) |
| | | | | | | D60 | : MT29.1JB | Q5, 15, 16, 33, 39, 40, 41, 44, | : 2SC2458(Y) or |
| | | | | | | D38 | : MT210JA | 46, 47, 49, 50, 51 | |
| | | | | | | D63 | : MT212JB | Q20, 43, 45 | : 2SC2458(Y) |
| | | | | | | | | Q6, 8, 34, 36 | : 2SC2459(BL) |
| | | | | | | | | Q7 | : 2SC2459(BL) |

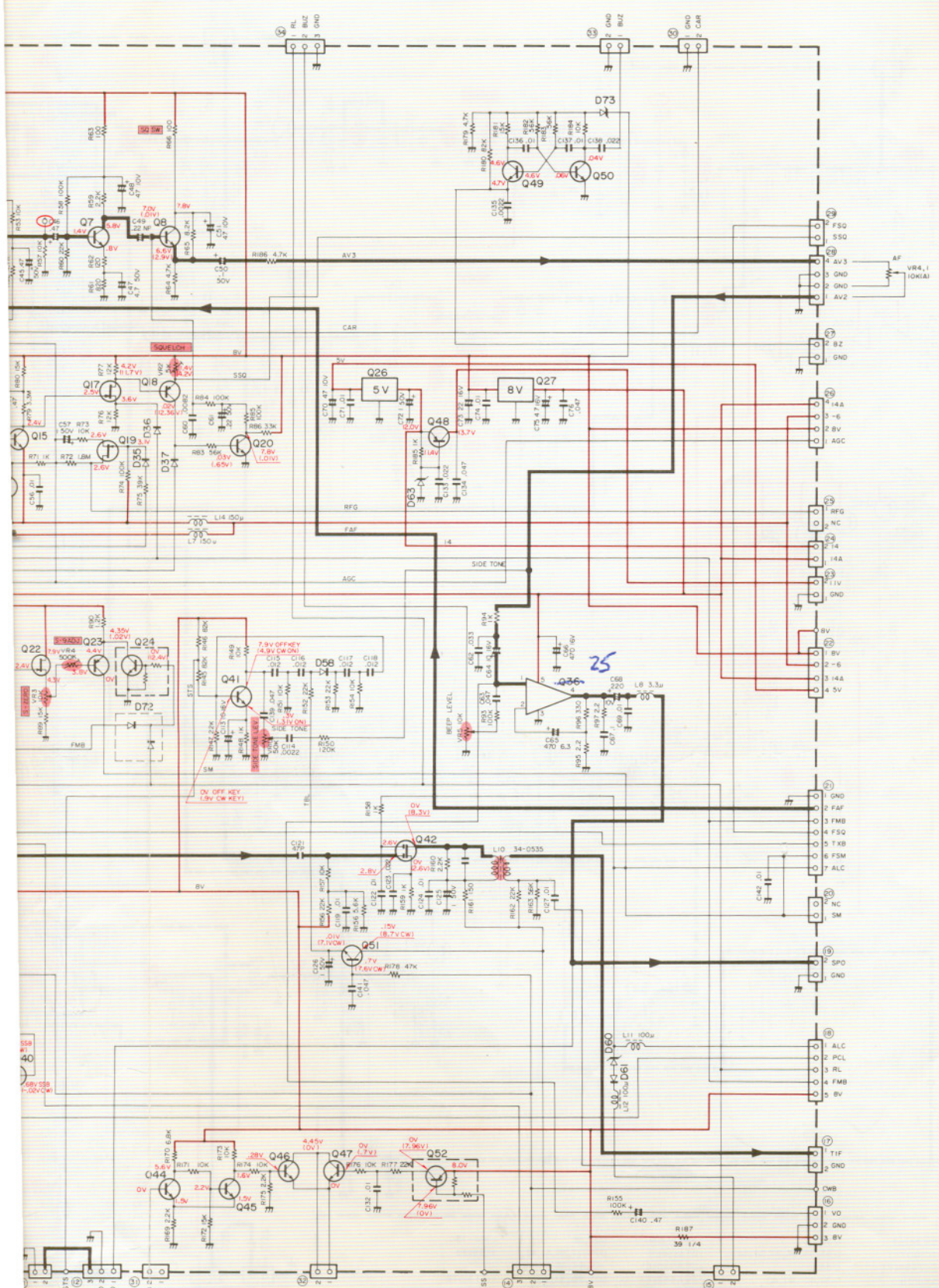

- 3SK73
- AN7805
AN7808
- DTA114ES
DTC114ES
- 2SD880
- AN612
- 2SC2459
2SC2458
- 2SA2703
2SA733
2SC2240
2SC1815
2SA1015
- 2SK30
- 2SK192
- 2SA1115
- μPC2002V

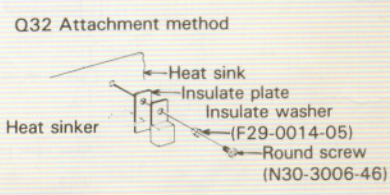

| | | | | | |
|--------------------------------|------------------------------|--------------------------------|----------------|-----|------------|
| Q23 | : 2SA1115(E) or 2SA1015(Y) | Q28, 48 | : 2SC2703(O,Y) | Q52 | : DTA114ES |
| Q9, 14, 16 | : 2SA733(R) | Q32 | : 2SD880(Y) | Q36 | : AN612 |
| Q5, 5, 16, 33, 39, 40, 41, 44, | : 2SC2458(Y) or 2SC1815(Y) | Q26 | : 2SK192(A,GR) | Q26 | : AN7805 |
| 46, 47, 49, 50, 51 | | Q17, 19 | : 2SK30(A,O) | Q27 | : AN7808 |
| Q20, 43, 45 | : 2SC2458(Y) | Q1, 4, 42 | : 3SK73(GR) | Q25 | : μPC2002V |
| Q6, 8, 34, 36 | : 2SC2459(BL) or 2SC2240(GR) | Q2, 21, 24, 29, 30, 31, 37, 38 | : DTC114ES | | |
| Q7 | : 2SC2459(BL) | | | | |

CONTROL UNIT (X53-1370-00)

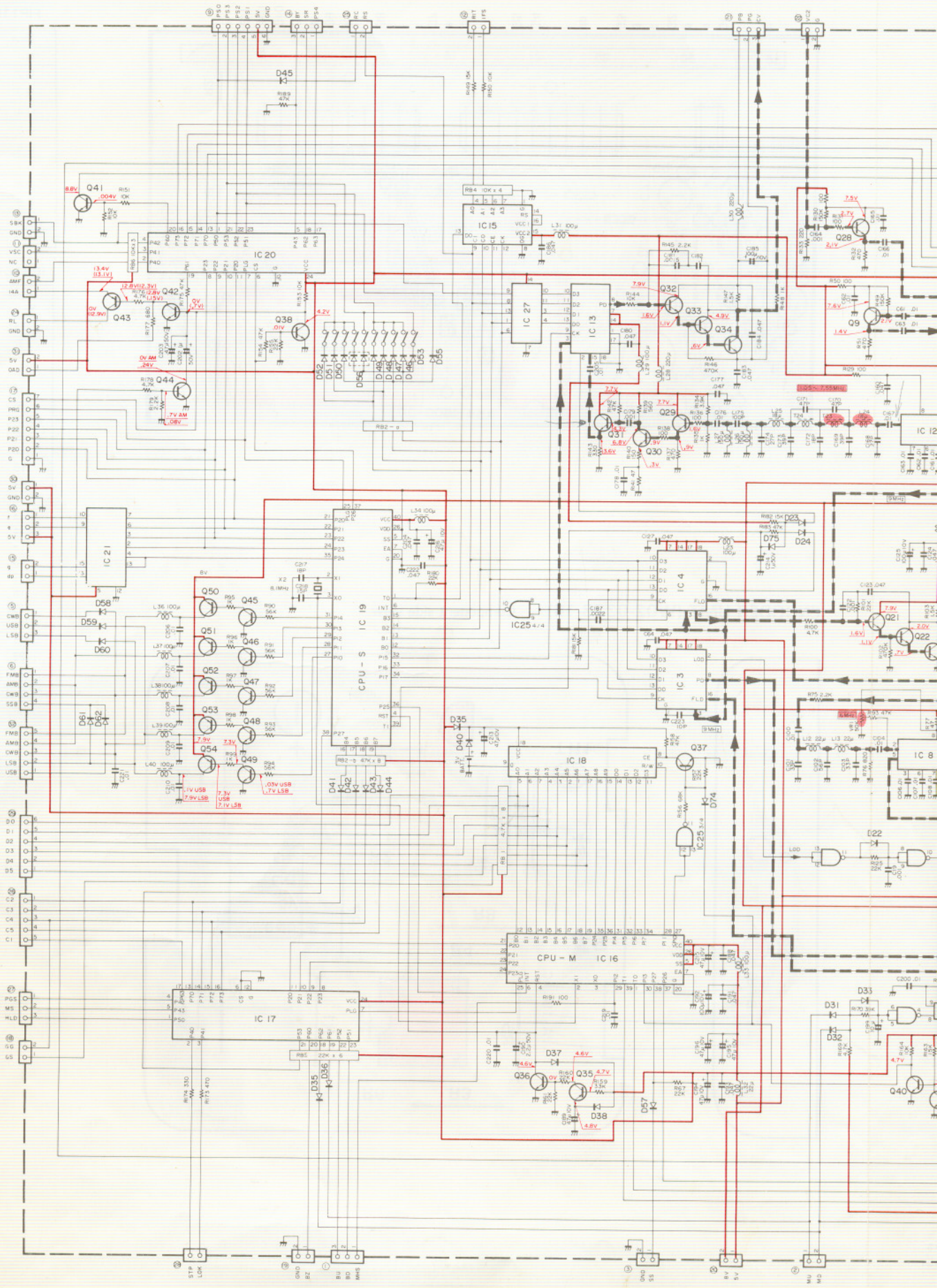

SCHEMATIC DIAGRAM TS-670

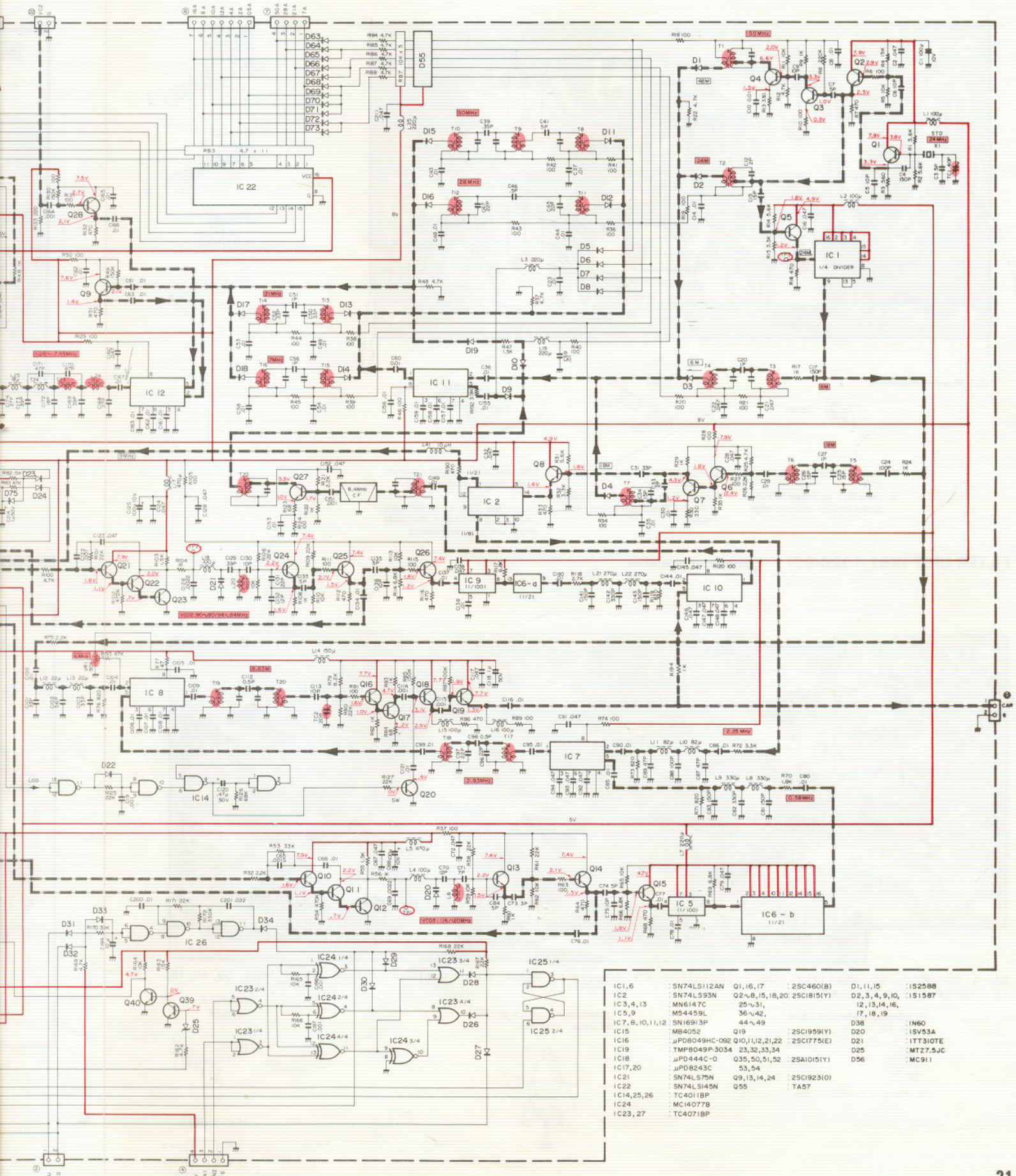

| | | | | | |
|----------------|----------------|-----------------|---------------|----------------------------------|------------|
| IC1,6 | : SN74LS112AN | Q1,16,17 | : 2SC460(B) | D1,11,15 | : 1S2588 |
| IC2 | : SN74LS93N | Q2~8,15,18,20 | : 2SC1815(Y) | D2,3,4,9,10,12,13,14,16,17,18,19 | : 1S1587 |
| IC3,4,13 | : MN6147C | 25~31 | | | |
| IC5,9 | : M54459L | 36~42 | | | |
| IC7,8,10,11,12 | : SN16913P | 44~49 | | | |
| IC15 | : MB4052 | Q19 | : 2SC1959(Y) | D38 | : IN60 |
| IC16 | : μPD049HC-092 | Q10,11,12,21,22 | : 2SC1775(X) | D21 | : 1T7310TE |
| IC19 | : TMP049P-3034 | 23,32,33,34 | | D25 | : MT7.5JC |
| IC18 | : μPD444C-O | Q35,50,51,52 | : 2SA1015(Y) | D56 | : MC911 |
| IC17,20 | : μPD8243C | 53,54 | | | |
| IC21 | : SN74LS75N | Q9,13,14,24 | : 2SC19213(O) | | |
| IC22 | : SN74LS145N | Q55 | : TA57 | | |
| IC14,25,26 | : TC4011BP | | | | |
| IC24 | : MC14077B | | | | |
| IC23,27 | : TC4071BP | | | | |

Signal Line

Control Line

Common

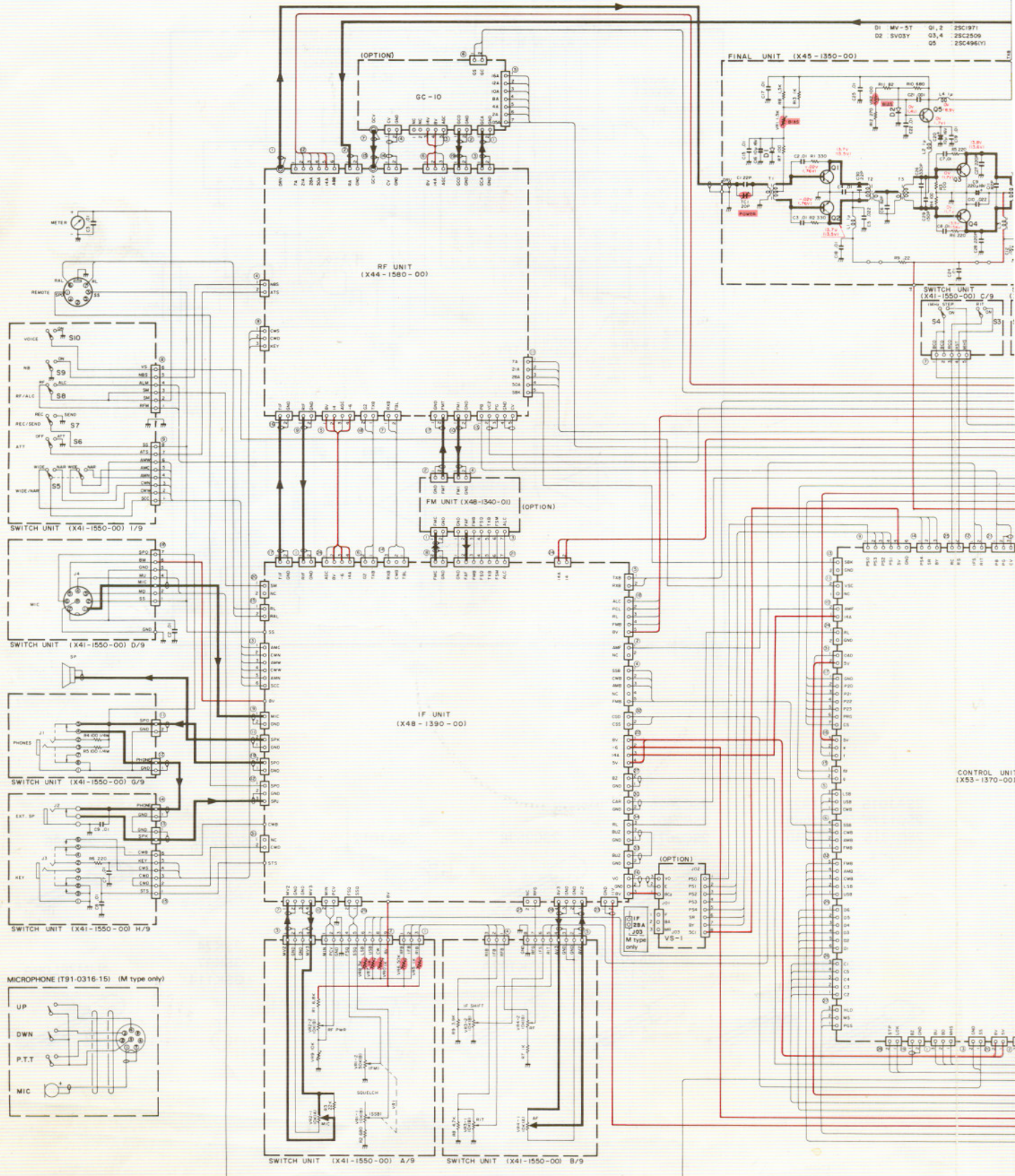

SCHEMATIC DIAGRAM TS-670

Common DC Line

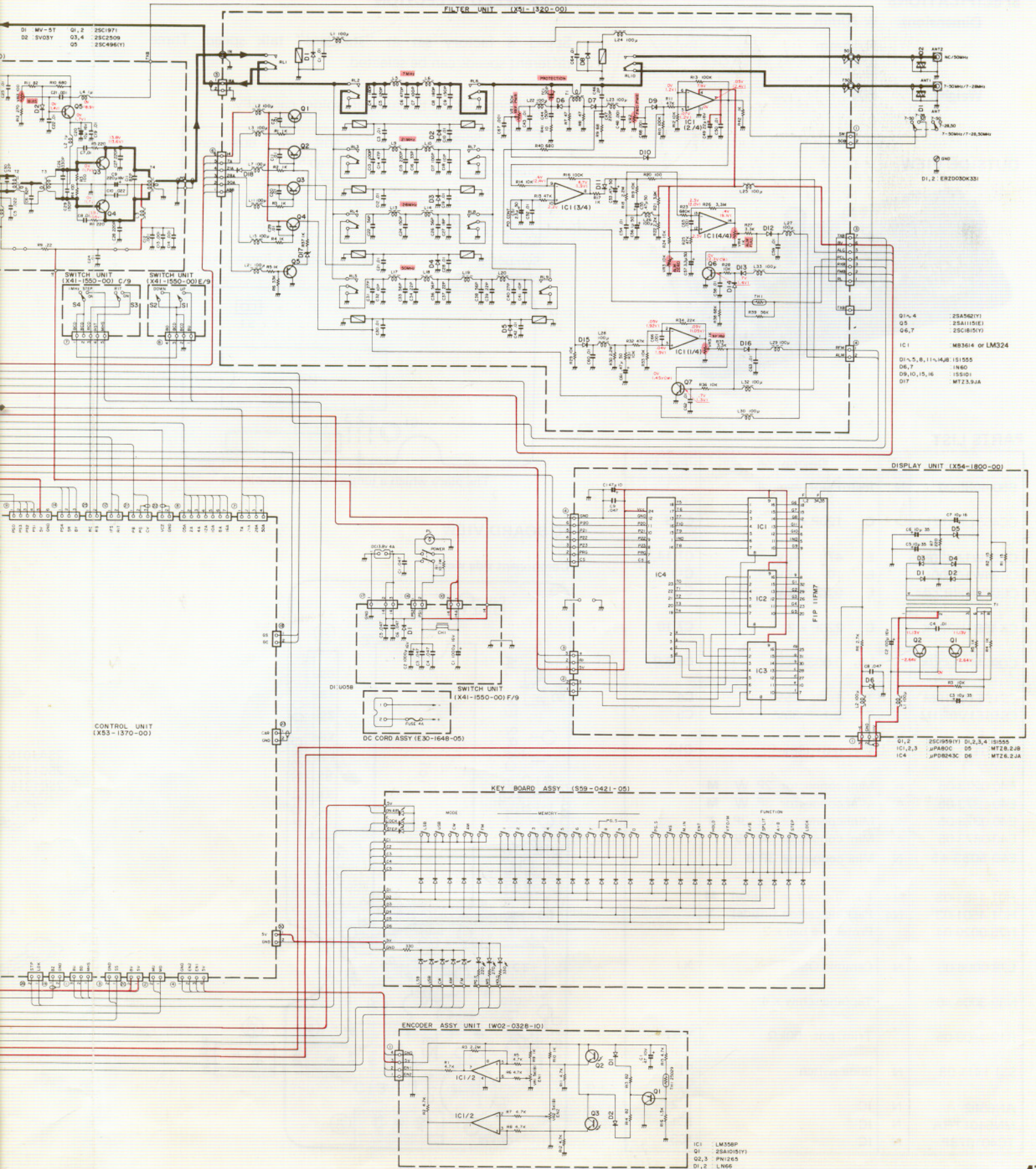

TS-670

OPTIONAL FORM NO. 430



TRIO-KENWOOD CORPORATION

Shionogi Shibuya Building, 17-5, 2-chome Shibuya, Shibuya-ku, Tokyo 150, Japan

TRIO-KENWOOD COMMUNICATIONS

1111 West Walnut Street, Compton, California 90220, U.S.A.

TRIO-KENWOOD COMMUNICATIONS

DIVISION OF TRIO-KENWOOD ELECTRONICS, GmbH

Rembrüker str. 15, 6056 Heusenstamm West Germany

TRIO-KENWOOD ELECTRONICS, N.V.

Leuvensesteenweg 504, B-1930 Zaventem, Belgium

TRIO-KENWOOD (AUSTRALIA) PTY. LTD. (INCORPORATED IN N.S.W.)

4E. Woodcock Place, Lane Cove, N.S.W. 2066, Australia