



## 2m ALL MODE TRANSCEIVER

# Model TR-9000



INSTRUCTION MANUAL

# INTRODUCTION

You are the owner of our latest product, the new TR-9000 transceiver. Please read this instruction manual carefully before placing your transceiver in service. The unit has been carefully engineered and manufactured to rigid quality standards, and should give you satisfactory and dependable operation for many years.

## AFTER UNPACKING

- Shipping container:  
Save the boxes and packing in the event your unit needs to be transported for remote operation, maintenance, or service.
- The following explicit definitions apply in this manual:  
**Note:** If disregarded, inconvenience only, no risk of equipment damage or personal injury.  
**Caution:** Equipment damage may occur, but not personal injury.

## CONTENTS

FEATURES .....	3
BEFORE USE .....	3
SPECIFICATIONS .....	4
SECTION 1. PREPARATION FOR USE .....	5
1.1 Accessories .....	5
1.2 Installation .....	5
SECTION 2. CONTROLS AND TERMINALS .....	8
2.1 Front panel .....	8
2.2 Rear panel .....	10
SECTION 3. OPERATION .....	11
3.1 Mode switch .....	11
3.2 Digital VFO .....	11
3.3 Search/D.step (DS) switch .....	11
3.4 Memory .....	12
3.5 Scan .....	12
3.6 TX Offset switch .....	13
3.7 Squelch .....	13
3.8 RIT and RIT switch .....	13
3.9 NB (Noise blanker) .....	13
3.10 RF GAIN and S meter .....	13
3.11 HI/LOW switch .....	14
3.12 Transmitter precautions .....	14
3.13 CW operation .....	14
3.14 Tone pad input .....	14
3.15 TX unit .....	15
SECTION 4. ADDITIONAL INFORMATION .....	15
SECTION 5. OPTIONAL ACCESSORIES .....	16
BLOCK DIAGRAMS .....	17
SCHEMATIC DIAGRAMS .....	19

## FEATURES

1. 2m all band transceiver for FM, SSB (USB, LSB), and CW operation.
2. Rotary click, 100Hz step digital 2-VFO system specifically designed for mobile operation.
3. Five-digit display indicates frequency of all operating modes.
4. TX OFFSET switch shifts frequencies  $\pm 600\text{kHz}$  for standard repeater operation.
5. Five memory channels. Two different frequencies (transmit and receive) are stored in CH5, permitting "odd-split" repeater operation.
6. Frequencies are searched quickly and automatically in SSB mode by the digital step switch.
7. Incorporates auto scan circuit (BUSY signal stops in FM mode). Free scan operation in all modes is also possible.
8. Hand microphone with frequency UP-DOWN switch.
9. Automatic selection of RIT, NB, RF GAIN and AGC. Self-contained side tone circuit.
10. RF POWER HI-LOW switch.
11. Unique escutcheon design allows easy installation for mobile operation.
12. Full variety of accessory terminals (KEY, TONE PAD, BACK UP, STBY, EXT SP).
13. Covering from 143.9000 to 148.9999MHz, the transceiver operates even on MARS repeaters within this range by using memory "5" for transmit offset frequency.

## BEFORE USE

**KEEP OUT**



Do not adjust coils, trimmers, or pots!  
These are factory adjustments.

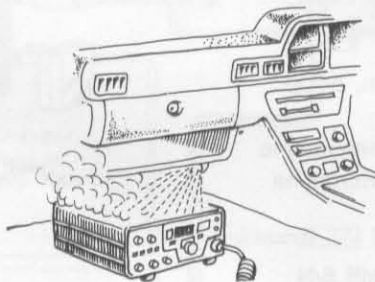

Do not install near heater outlet.



BEFORE connection, check polarity.



This unit is descended for 12V, negative ground ONLY.



After parking in the sun, and inside temperature is HOT, cool this unit BEFORE transmitting.

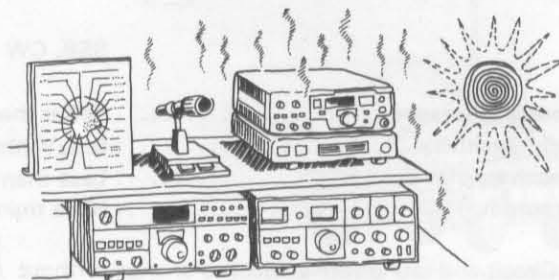

Keep equipment away from heat and out of direct sunlight.

# SPECIFICATIONS

## [General]

Semiconductors .....	ICs	12
	FETs	16
	Transistors	87
	Diodes	141
Frequency range .....	144.000.0 to 147.999.9MHz	
Frequency synthesizer .....	Digital control, phase locked VCO	
Mode .....	SSB (A3j), FM (F3), CW (A1)	
Frequency stability .....	Within $\pm 500\text{Hz}$ during the first hour after 1 minute of warm up, and within 50Hz any 30 minutes thereafter at 25°C (constant).	
Power requirement .....	13.8V DC $\pm 15\%$	
Grounding .....	Negative	
Operating temperature .....	- 20°C to +60°C	
Current drain .....	0.4A in receive mode with no input signal 2.9A in HI transmit mode (Approx) 1.3A in LOW transmit mode (Approx) Less than 2.5mA for memory back up	
Dimensions .....	170mm (6-11/16) wide 68mm (2-11/16) high 234mm (9-3/16) deep (projections not included)	
Weight .....	2.5 kg (5.5 lbs)	

## [Transmitter Section]

RF output power (at 13.8V DC, 50 $\Omega$ load) ....	HI (SSB, FM, CW)	10W
	Low (FM, CW)	1W approx.
Modulation .....	FM	Variable reactance direct shift
	SSB	Balanced modulation
Frequency tolerance .....	SSB, CW	Less than $\pm 10 \times 10^{-6}$
	FM	Less than $\pm 20 \times 10^{-6}$
Spurious radiation .....	HI	Less than -60dB
	LOW	Less than -46dB
Carrier suppression .....	Better than 40dB	
Unwanted side band suppression .....	Better than 40dB	
Maximum frequency deviation (FM) .....	$\pm 5\text{kHz}$	
Microphone .....	Dynamic microphone with PTT switch, 500 $\Omega$	

## [Receiver Section]

Circuitry .....	FM	Double conversion superheterodyne
	SSB, CW	Single conversion superheterodyne
Intermediate frequency .....	1st IF	10.695MHz
	2nd IF (FM)	455kHz
Receiver sensitivity .....	FM	Better than 0.5 $\mu\text{V}$ for 30dB S/N Better than 0.25 $\mu\text{V}$ for 12dB SINAD
	SSB, CW	0.25 $\mu\text{V}$ for 10dB S/N
Receiver selectivity .....	FM	More than 12kHz (-6dB) Less than 25kHz (-60dB)
	SSB, CW	More than 2.2kHz (-6dB) Less than 4.8kHz (-60dB)
Spurious interference .....	Better than 70dB	
Squelch sensitivity .....	0.2 $\mu\text{V}$ (threshold)	
Auto scan stop level .....	Less than 0.25 $\mu\text{V}$ (threshold)	
Audio output .....	More than 2.0 watts across 8 ohm load (10% dist.)	

**Note:** Circuit and ratings are subject to change without notice due to developments in technology.

# SECTION 1. PREPARATION FOR USE

## 1.1 Accessories

Carefully unpack your TR-9000 and check that it is supplied with the following accessories:

- (1) Dynamic microphone (with U/D switch)  
(T90-0313-05) ..... 1 piece
- (2) Mounting bracket ..... 1 assy  
Mounting parts:  
Hex wrench (W01-0401-04) ..... 1 piece  
Nuts (5mm diameter) (N14-0510-04) ..... 4 pieces  
Hex-socket screw (N09-0008-04) ..... 4 pieces  
Flat washers (6mm diameter)  
(N15-1060-46) ..... 4 pieces  
Spring washer (6mm diameter)  
(N16-0060-46) ..... 4 pieces
- (3) Leg (for fixed station) (J02-0416-04) ..... 1 pieces
- (4) DC power cord (with 2P plug and fuse)  
(E30-1648-05) ..... 1 piece
- (5) Spare fuse (4A) (F05-4022-05) ..... 1 piece
- (6) Miniature plug (for stand-by) (E12-0401-04) ... 1 piece
- (7) Miniature plug (for external speaker or key)  
(E12-0001-05) ..... 1 piece

- (8) Miniature plug (for TONE PAD) (E09-0471-05) ... 1 piece
- (9) Warranty card ..... 1 piece
- (10) Instruction manual ..... 1 copy

## 1.2 Installation

### 1.2.1 Interconnection

Connect the antenna and power supply as shown in Fig. 1-1 for fixed station or mobile operation.

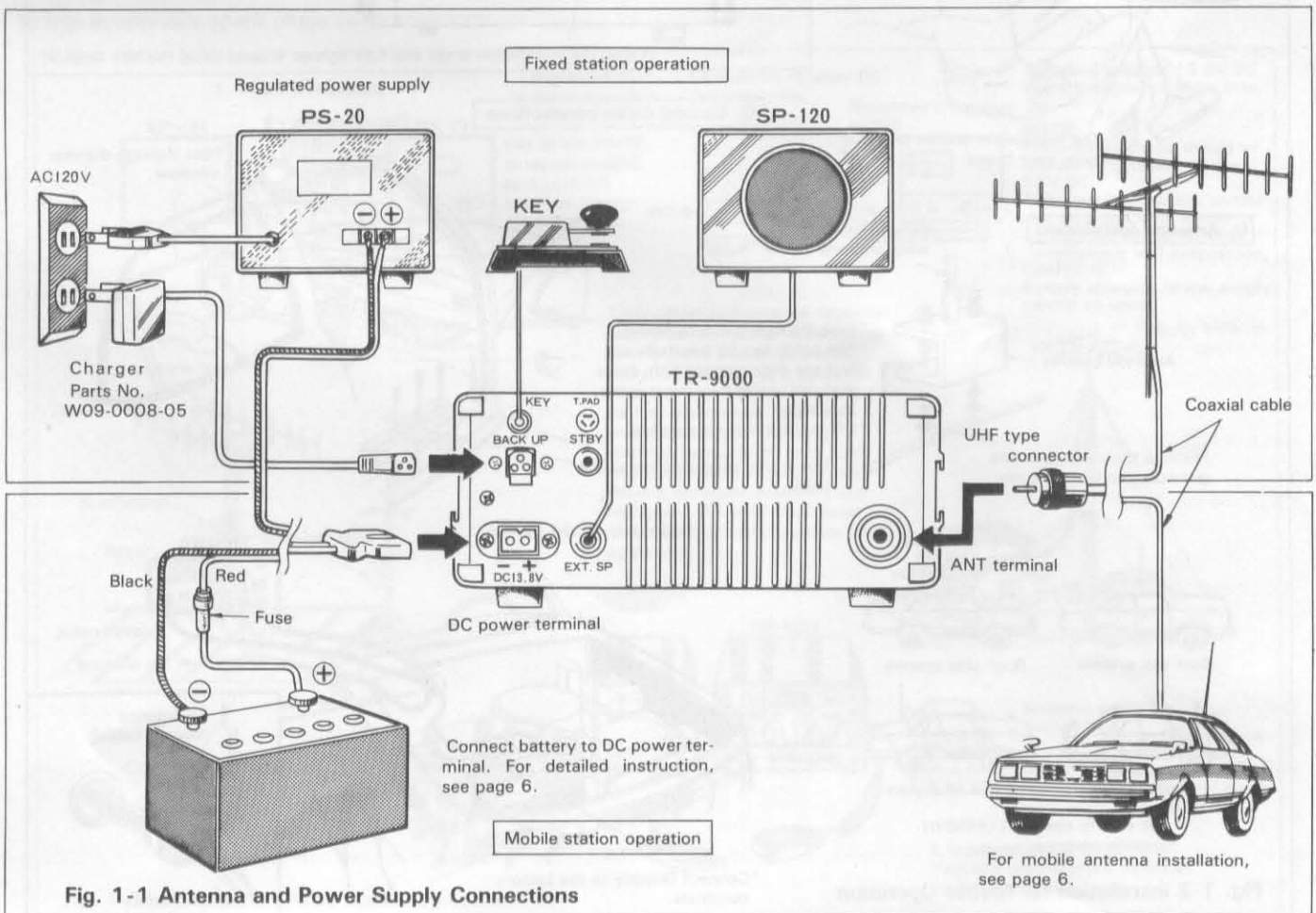

Fig. 1-1 Antenna and Power Supply Connections

**1.2.2. MOBILE installation, [general]**

**• Installation location**

Using the supplied mounting bracket, install the transceiver under the dashboard or on the side of console in your car.

Refer to Fig. 1-2A and Fig. 1-2B.

If your car is equipped with an electronic fuel injector, the transceiver should be as far from the control, equipment as possible.

**A. Installation position**

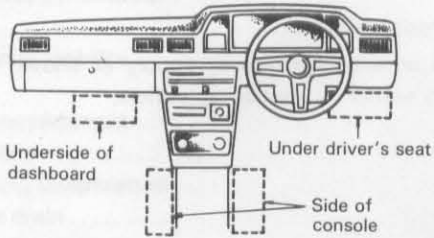

Drill holes in the bottom of dashboard. Secure the mounting bracket with screws and nuts.

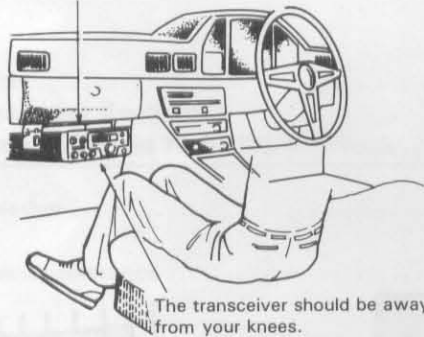

**B. Installation of mounting bracket**

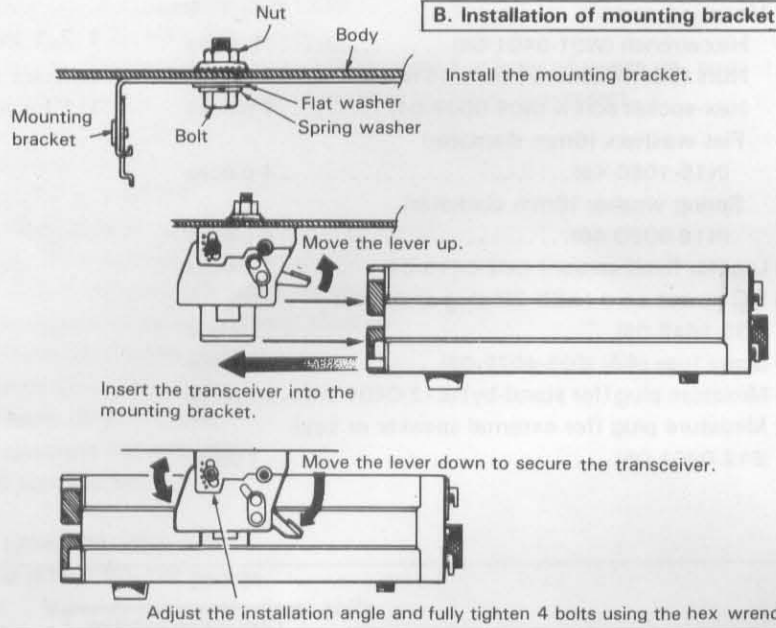

**C. Antenna Installation**

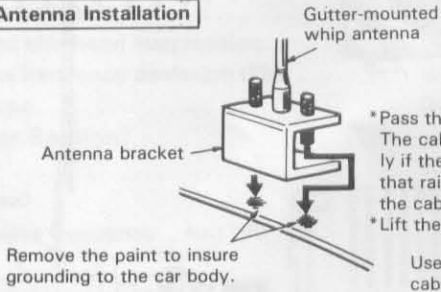

\* Pass through the door fitting. The cable can be inserted easily if the door cushion soft. Note that rain water may enter along the cable.  
\* Lift the Drip-loop if possible.

Use a trim plate and install the cable.

**D. Coaxial cable connections**

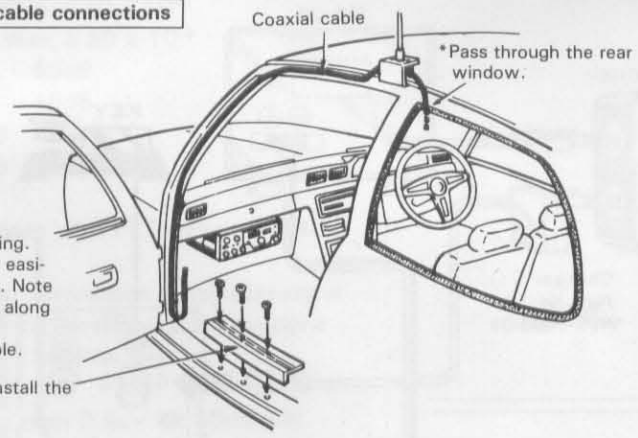

\* Insert through the bonnet.

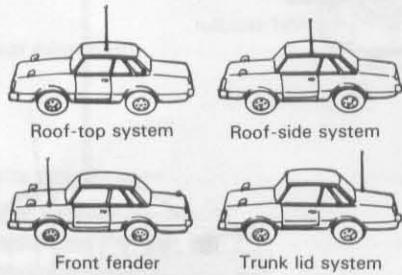

Be sure to use 2m (144MHz) mobile antenna.

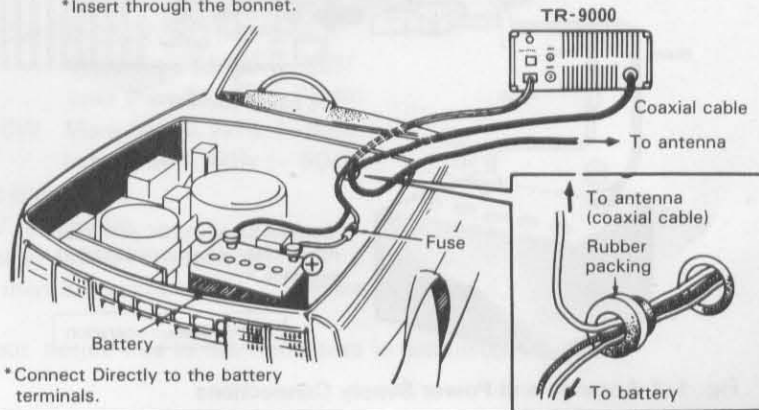

**Fig. 1-2 Installation for Mobile Operation**

• **Antenna installation**

Various types of antennas for 2 meters mobile operation are available. (See Fig. 1-2C)

**NOTE:**

For gutter-mount installation, the antenna bracket must be grounded to the car body as shown in Fig. 1-2C. Affix the antenna securely, referring to the antenna instruction.

• **Power supply**

Connect the supplied power cord with fuse directly to the battery terminals. Connecting to the cigarette lighter socket can cause a poor connection, and excessive voltage drop.

• **Back up power for micro-computer**

With power supplied from battery, the micro-computer keeps operating even when the power switch is OFF. In this case, current drain is very low, approximately 2.5mA. The car can be parked overnight with little battery power consumed.

However, when the car is to be parked for a long period of time (more than 1 month), it is advisable to disconnect the power plug, in this case, the back up function is disabled.

• **Ignition noise**

The transceiver is designed to suppress ignition noise; however, if excessive noise is present, it may be necessary to use suppressor spark plugs (with resistors).

**1.2.3. FIXED STATION installation, [general]**

• **Power supply (Fig. 1-3)**

The PS-20 optional power supply is recommended.

• **Antenna (Fig. 1-3)**

Various types of fixed station antennas are commercially available. Select your desired antenna according to your installation space and application (DX, local QSO, etc.). Note that the SWR of your antenna should be less than 1.5. A high SWR will cause the TR-9000 protective circuit to operate, reducing the transmit output power.

The TR-9000 is factory adjusted to deliver the rated RF output (10W) at about 146MHz, where the RF meter indicates "8" on the 10-division (lower) uniform scale. The RF meter will indicate about this point when the antenna SWR is less than 1.5.

• **Micro-computer back up (retention of memory function)**

Unless the power source is disconnected, the micro-computer keeps its back up function even if the power switch is turned OFF. If you desire back-up with the power source disconnected, plug the battery charger (Parts No. W09-0008-05) or BO-9 System Base (option) back-up power cable into the back-up power socket on the rear of the TR-9000.

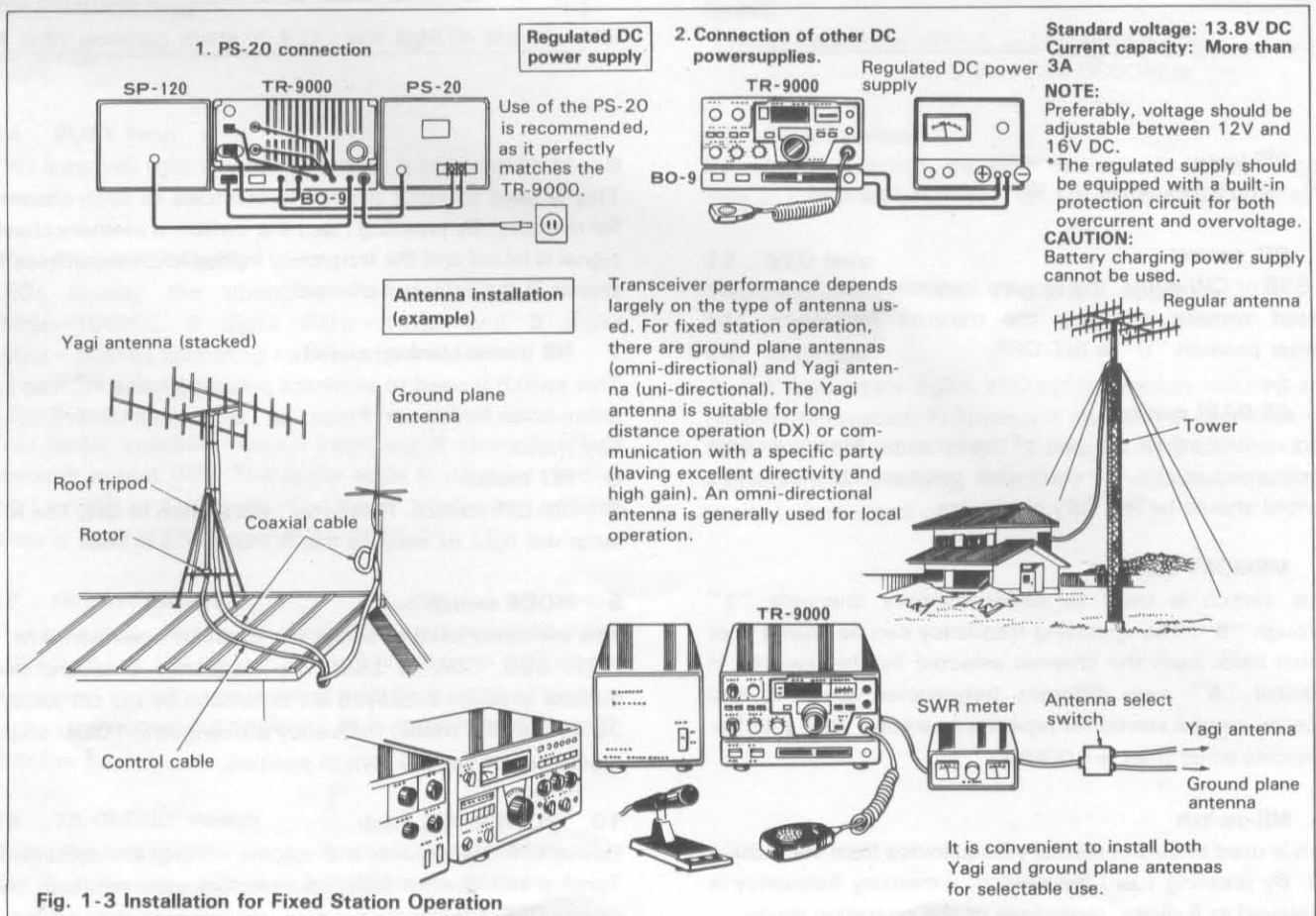

## SECTION 2. CONTROLS AND TERMINALS

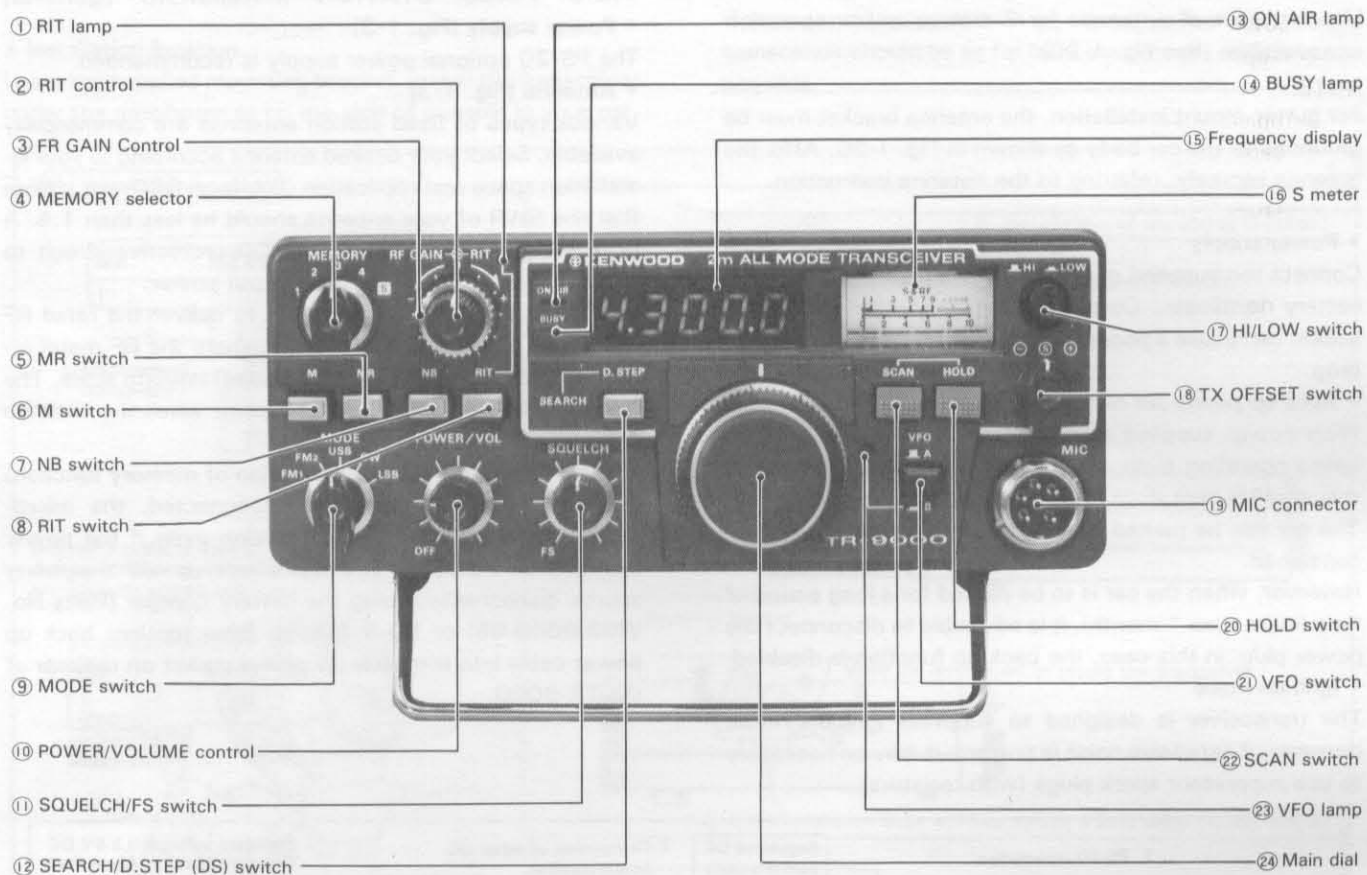

### 1 RIT lamp

This lamp lights when the RIT circuit is operated.

### 2 RIT control

In SSB or CW mode, the receive frequency can be fine adjusted without changing the transmit frequency. The center position "0" is RIT-OFF.

### 3 RF GAIN control

This control adjust the gain of the receiver. Maximum gain is obtained at the full clockwise position. Normally, this control should be left fully clockwise.

### 4 MEMORY selector

This switch is used to select memory channels "1" through "5". The operating frequency can be stored in or called back from the channel selected by this switch. In channel "5", two different frequencies (transmit and receive) can be stored for repeater operation with split frequencies other than  $\pm 600\text{kHz}$ .

### 5 MR switch

This is used to output memory frequencies from each channel. By pressing (■) the switch, a memory frequency is displayed in 5 digits, regardless of the operating mode.

### 6 M switch

This is used to input desired frequencies to each channel for memory. By pressing (■) the switch, a memory check signal is heard and the frequency indicated on the display is stored in the selected channel.

### 7 NB (noise blanker) switch

This switch is used to eliminate pulsating noise such as ignition noise from a car. Press (■) the switch ON in SSB or CW mode.

### 8 RIT switch

RIT ON-OFF switch. Press (■) the switch to ON. The RIT lamp will light to indicate the RIT circuit is in use.

### 9 MODE switch

This switch is used to select the mode of operation, FM1, FM2, USB, CW, or LSB. The frequency step and the number of digits displayed are controlled by the DS switch (12). In the FM1 mode, frequency is changed in 10kHz steps regardless of the DS switch position.

### 10 POWER/VOL knob

Power ON-OFF switch and volume control are combined. Turning the control fully counterclockwise will turn the power OFF. Clockwise rotation will increase the volume.



## SECTION 3. OPERATION

In the power OFF position, about 2.5mA current is drawn to back-up the micro-computer, provided the power cable is connected to a constant power source.

To completely disable the transceiver, disconnect the power cable.

### 11 SQUELCH/FS knob

The squelch control is used to eliminate noise during no-signal time. Normally, this control is adjusted clockwise until the noise disappears and the BUSY lamp goes off (threshold level). The squelch circuit operates only in the FM mode. In the FS position, the transceiver is set in Free Scan during FM operation. For auto scan, the squelch knob should be set to the threshold point.

### 12 SEARCH/D.STEP (DS) switch

By using this switch, frequencies are shifted rapidly. Press the switch to ON. In the FM1 mode, frequencies are shifted in 10kHz step regardless of switch position. In the FM2 mode, the frequency step is 5kHz when the switch is ON. In the SSB or CW mode, the "kHz" and "100Hz" frequency data being displayed are set to "□.□", then the frequencies up to 10kHz are searched at 100Hz intervals. Frequency is shifted rapidly during search.

### 13 ON AIR lamp

A light emitting diode (L.E.D.) will light in the transmit mode.

### 14 BUSY lamp

This lamp will light when the squelch is open in FM receive mode.

### 15 Frequency display

LEDs display the operating frequency in 5 digits (MHz-100Hz), 4 digits (MHz-1kHz) and 3 digits (MHz-10kHz) according to the frequency step.

### 16 S-meter

This meter indicates receive input signal strength (S) or transmit output (RF). The upper scale is used for reading "S" in SSB or CW mode. The lower 10-division uniform scale is used in FM mode. (B31-0625-05)

### 17 HI/LOW switch

This switch is used to set transmit output power to either 10W (high) or 1W (low) in FM or CW mode. In SSB mode, the power is high regardless of switch position. Power is high at the normal out position (■), and is low at the position (■).

### 18 TX OFFSET switch

Shifts the transmit frequency for repeater operation.

⊕: Switches the transmit frequency up 600kHz from the receive operation.

⊙: Simplex (receive and transmit frequencies are the same.)

⊖: Switches the transmit frequency down 600kHz from the receive frequency.

### 19 MIC connector (6-pin)

For connection of the supplied microphone.

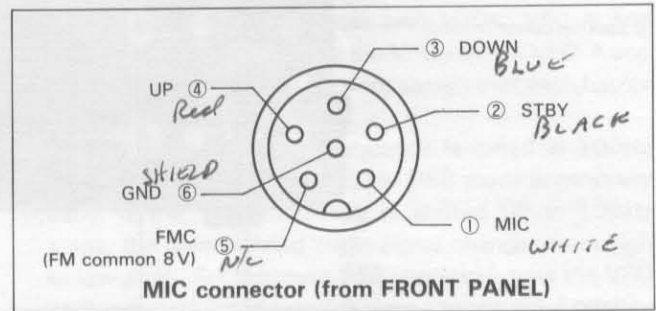

### 20 HOLD switch

This switch is used to release scan operation.

### 21 VFO switch

This is used to select VFO-A VFO-B. The VFO-A and VFO-B are actually the same, except reset frequency is different.

Reset frequency: VFO-A ... 146.0000MHz  
VFO-B ... 144.0000MHz

### 22 SCAN switch

By using this switch, the scan operation is started according to the mode step (VFO should be used).

### 23 VFO lamp

This lamp will light when VFO-B is in operation.

### 24 Main dial

A click type rotary digital VFO control selects transmit and receive frequencies. Frequency is changed at each click according to the mode step. This digital VFO control is an endless type, changing frequency continuously from the upper to lower end of the band.

## SECTION 2. CONTROLS AND TERMINALS

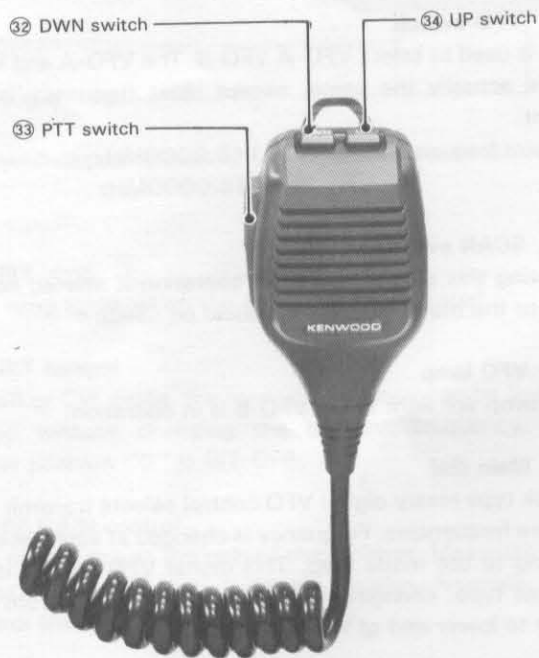
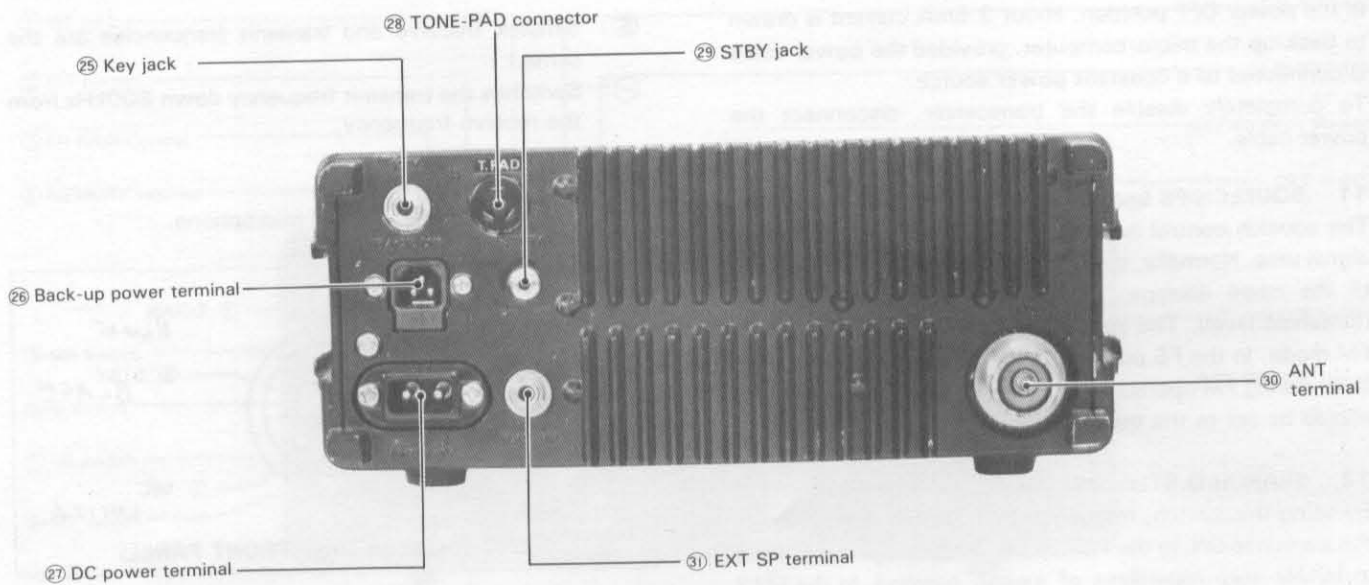

### 25. KEY jack

For connection of a key using the supplied plug. Use shielded Line and observe polarity.

### 26. Back up power terminal

Used for fixed station operation. The micro-computer retains the VFO frequency memory function even when the power supply is turned OFF, when back-up power is supplied.

### 27. DC power terminal

DC power input terminal. Connect the supplied power cord with plug. Input voltage is 13.8V DC. Observe plus (+) and minus (-) polarity is correct.

### 28. TONE PAD connector

Tone pad input for "autopatch" operation. Connect with the supplied Plug.

### 29. STBY jack

For connection of an external standby switch (transmit/receive select switch). Use the supplied plug.

### 30. ANT terminal

Antenna terminal. Connect an antenna of 50 ohms impedance.

### 31. EXT SP terminal

External speaker terminal. Connect a speaker of 8 ohm impedance using the supplied plug.

### 32. DWN switch

This switch is used to step down the digital VFO frequency. When operating the switch, tone will sound.

### 33. PTT switch

Press-to-talk switch used for transmission. This will also release scan operation.

### 34. UP switch

This switch is used to step up the digital VFO frequency. When operated, a tone will sound. When the DWN or UP switch is continuously the frequency shifts rapidly. Pressing both the UP and DOWN switches simultaneously results in stopping the VFO operation.

# SECTION 3. OPERATION

## 3.1 MODE SWITCH

The five-position MODE switch functions as follows:

- FM1: FM frequency is selected in 10 kHz steps by using the VFO, regardless of the DS switch position.
- FM2: In this mode, FM frequencies are selected in either 100 Hz or 5kHz steps.
- USB: Normal mode for 2m SSB. Frequencies are tuned in 100 Hz steps.
- CW: CW mode operates A1. KEY jack and STBY jack are provided on the rear of the TR-9000. Connect a key for CW operation. The filter for SSB mode is also used for CW mode. The AGC time constant is automatically "fast".
- LSB: This mode is not used for 2m SSB, but is used for special operation such as Oscar satellite communication.

## 3.2 DIGITAL VFO

The TR-9000 incorporates a digital 100 Hz step 2-VFO system (click type rotary) controlled by micro-computer.

### Note:

1. Since all the functions are controlled by a microcomputer, the transceiver must be operated in the priority order given in the following Table.  
For example, the digital VFO will not operate when the main dial is turned during MR operation. Also, it will not operate unless scan operation is released by the HOLD switch or the microphone PTT switch, even if scan is stopped for a brief period of time in receive mode.

Sequence/Operation	Function	Switch and Controls
1	Memory recall	MR ON
2	Scan operation	SCAN, HOLD ON
3	UP/DOWN operation	UP/DOWN ON
4	Digital VFO	Main dial
5	Memory Write	M ON
6	Search operation	DS Switch ON

Table 3-1

2. The micro-computer is programmed to operate in receive mode, except one transmit frequency is also stored in memory channel "5". Note that the main dial and UP/DWN controls do not function during transmission.
3. **The digital VFO is factory adjusted under rigid quality standards to insure excellent frequency linearity and stability.**

### • Tuning

1. Operating frequencies are basically tuned by the main dial. Turning the dial to the right will shift the frequency UP. If fine adjustment is desired in SSB or CW mode, the RIT circuit may be operated.

2. The digital VFO can be step tuned by the microphone UP/DWN switches. A tone will sound at each switch press. The VFO frequency shifts rapidly when the switch is continuously depressed. The tone will then become continuous.
3. The digital VFO covers the 2m band from 143.9000 to 148.9999MHz in continuous mode. The VFO can be tuned either left or right.
4. The transceiver incorporates two VFOs, VFO-A and VFO-B. VFO Selection is by the VFO switch. VFO-A and VFO-B are the same in function, except that each has its own reset frequency.
5. In SSB mode, the VFO frequency is tuned in 100Hz steps. In 2m SSB operation, the USB mode is generally used. If the VFO frequency is shifted UP in 100Hz steps, the demodulated audio signal changes from high to low pitch. For optimum SSB operation, tune the VFO so the demodulated signal is clear and natural. Frequency can be fine tuned by the RIT,  $\pm 1.0$ kHz from the frequency displayed.
6. In FM mode, the RIT circuit does not operate, since a signal can be heard clearly even when its frequency is  $\pm 1.0$ kHz.

### • Frequency display

1. The digital frequency display indicates carrier frequency in SSB and FM modes. The frequency displayed is the operating frequency.
2. In CW mode, the frequency display indicates the receiver carrier frequency. Transmit frequency is 800Hz higher than displayed. (Operating frequency is 800Hz higher than displayed when receiving an 800Hz beat note.) (See Fig. 3-1).

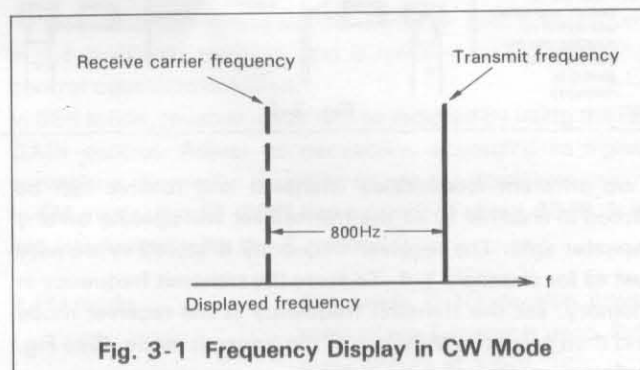

Fig. 3-1 Frequency Display in CW Mode

## 3.3 SEARCH/D.STEP (DS) SWITCH

This is one of the special features of the TR-9000. The basic function of this switch is to change the frequency shift from 100Hz to 10kHz step. In FM1 mode, the frequency shift step is independent of the DS switch. In SSB/CW mode, both search and frequency shift are in 10kHz steps.

Function Mode	DS : OFF		DS : ON	
	Step	No. of display digits	Step	No. of display digits
FM 1	10 kHz	3 digits	10 kHz	3 digits
FM 2	100 Hz	5 digits	5 kHz	4 digits
USB CW LSB	100 Hz	5 digits	10 kHz	5 digits The 0.0-9.9kHz range is repeatedly searched in 100Hz steps.

When the DS switch is ON in SSB/CW mode, the frequency is searched, that is, the digits for "kHz" and "100Hz" are set to "00" and the 0.0 to 9.9kHz frequency range is swept repeatedly at a speed of 60mS per step. If a signal is present during search swept, tone will be heard, allowing you to check the signal in SSB mode. It is thus possible to locate stations quickly.

**NOTE:**  
If the transmitters are keyed in this Mode, a momentary tone will sound to remind you that the transceiver is in search mode.

### 3.4 MEMORY SWITCH

Using this switch, commonly used frequencies (repeaters, etc.) can be stored in the memory. Frequencies set by the VFO are stored in channels 1 through 5 by using the M switch. Stored frequencies can be called-up by placing the MR switch ON.

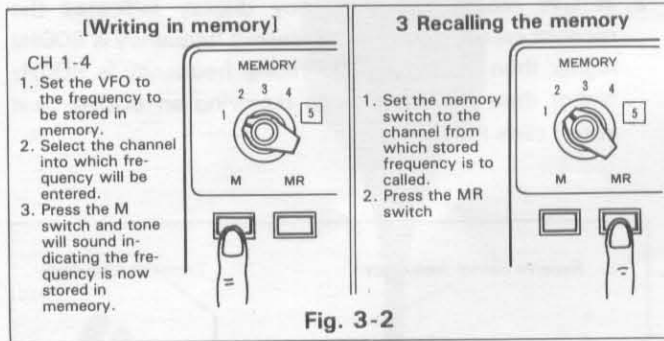

Two different frequencies (transmit and receive can be stored in channel 5, so the transceiver will operate on any repeater split. The receiver frequency is stored in memory just as for channels 1-4. To store the transmit frequency in memory, set the transmit frequency in the receiver mode and then press the M switch in the transmit mode. (See Fig. 3-3)

**NOTE:**

- When a memory is vacant, the memory frequency is 144.0000MHz.
- The memory frequency called-up by the MR switch is displayed in 5 digits, regardless of mode.

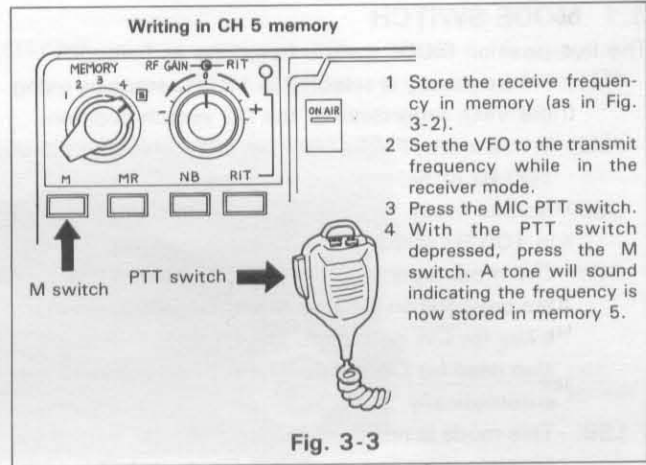

- To clear a frequency stored in memory, simply store a new frequency in that memory.
- If you desire to retain the memories, back-up power should be supplied to the micro-computer
  - A power cord should be connected directly to the battery terminal.
  - A back-up supply (Part No. W09-0008-05) should be used.

In either case, back-up current of about 2.5mA is required.
- If power is disconnected, the back-up function is retained for only 1-1.5 sec. If instantaneous voltage drop at engine starting continues for more than 2 sec, the micro computer will be reset and the memory cleared.
- If you wish to retain the memories even when changing the installation between the car and the fixed station, utilize a back-up cord as shown in Fig. 3-4.

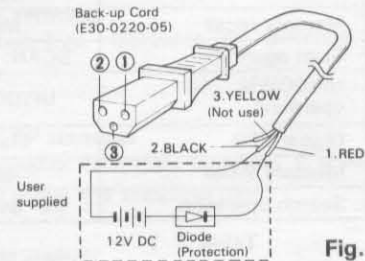

### 3.5 SCAN OPERATION

TR-9000 scan operation is classified into auto scan (signal stops at a certain point and scan restarts when signal is absent) and free scan.

- Auto scan**  
Auto scan is available only in the FM mode.
  - Set the squelch control to the threshold point (noise disappears at no-signal time and BUSY lamp goes off).
  - Next, press the SCAN button to start scan operation.
  - When a signal is present, scanning stops. When the signal drops scan restarts automatically.

4. If you desire to hold the frequency at which the scan stops, press the HOLD button or press the microphone PTT switch ON momentarily. Scan will be released and the transceiver will return to normal operation.
5. Scan speed is about 120ms for each channel. When the scan button is continuously depressed, scan speed is doubled.
6. In the auto scan operation, it may be better to use FM1 mode (10kHz step) in crowded FM areas.
7. Effective auto scan operation cannot be obtained with 100Hz step FM (FM2, DS OFF).

• **Free scan**

1. In SSB or CW mode, press the SCAN button and the transceiver will operate in a free scan mode. Auto scan is not possible in SSB/CW mode.
2. When the SCAN button is pressed with DS ON (search operation), your SSB frequency is scanned automatically.
3. For free scan operation in FM mode, set the squelch control to the F.S. position and press the SCAN button. Scanning will not stop when a signal is present.
4. To stop the scan, press the HOLD button or the microphone PTT switch, as for auto scan. The transceiver will return to normal operation.

• **Scan Operation Precautions**

1. During scan operation, including temporary scan stop, the frequency can not be changed by the VFO or the microphone UP/DWN switches. To change frequency, it is first necessary to release the scan by pressing the HOLD button or MIC PTT switch.
2. If the MR switch is pressed during scan operation, the memory frequency is output. When this switch is released, scanning will not resume.

### 3.6 TX OFFSET SWITCH

The TX OFFSET switch, used for selecting simplex or repeater operation, has three positions.

If the transmitter frequency is shifted beyond the high or low frequency limits, the transceiver will operate in simplex mode, and a warning tone will sound during transmit.

- ⊕: The transmitter frequency is 600 kHz higher than the receiver frequency.
- Ⓢ: The TR-9000 operates in the usual simplex mode. That is, receive and transmit frequencies are the same. This frequency is indicated on the digital frequency display (15).
- ⊖: The transmitter frequency is 600 kHz lower than the receiver frequency.

**NOTE:**

OFFSET is available for all modes.

### 3.7 SQUELCH

The squelch circuit operates only in the FM mode.

To eliminate the noise at no-signal condition turn the squelch slowly clockwise until the noise disappears and the BUSY lamp goes off (threshold point).

Adjust the VFO to an empty frequency. The BUSY lamp will light and the speaker will operate when a signal is received. The squelch control is also used for auto scan operation control.

If the signal is weak or fades during mobile operation, readjust the squelch for the clearest reception.

### 3.8 RIT AND RIT SWITCH

"RIT" is an abbreviation for "receiver incremental tuning". The RIT feature enables you to shift receive frequency approximately  $\pm 1$ kHz. By adjusting the RIT control in the "+" direction, the receive frequency will be higher than the transmit frequency (and vice versa).

When the RIT control is set to the center "0" position, the frequency is the same as that at RIT OFF, and the frequency indicated on the digital display remains unchanged.

If the receive frequency is incorrect, it can be adjusted by turning the RIT switch ON (the RIT lamp will light). Since the receive frequency can be varied without changing the transmit frequency, there is a difference between the transmit and receive frequencies. Therefore, the RIT switch should be turned OFF when the QSO is finished.

Note that the RIT circuit is available in SSB or CW mode and does not operate in FM1 or FM2 modes.

### 3.9 NB (NOISE BLANKER)

The noise blanker is used to reduce ignition type impulse noise generated from a car, and allows reception of weak CW or SSB signals. The noise blanker will not operate in the FM modes.

### 3.10 RF GAIN AND S METER

The RF GAIN control, which is used to control receiver, gain has a range of more than 60dB in SSB or CW mode. Since the RF GAIN function is interlocked with the AGC, it is used to control strong signals. Receiver gain is maximum at full clockwise position, and is reduced by adjusting the control counterclockwise.

In SSB mode, receiver noise can be reduced by using the RF GAIN control. Adjust as necessary, according to signal conditions. Normally, it should be set for maximum gain.

**In FM mode, the RF GAIN has a range of about 20dB. It is not interlocked with the S meter.**

- FM mode ..... The lower 0-10 division linear scale of the S meter is used. Full scale occurs at  $15\mu\text{V}$ .
- SSB/CW mode ..... The upper scale of the S meter is used. The meter reads S-9 at  $5\mu\text{V}$  input and full scale at 1mV.

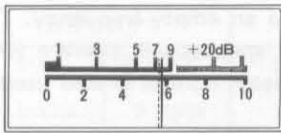

Fig. 3-5 S Meter

### 3.11 HI/LOW SWITCH

For local FM communication, it is recommended that power be reduced to eliminate interference to other stations and to minimize power consumption. By pressing the HI/LOW switch, transmit power is reduced from 10W to about 1W, while the RF meter reading is about 2 or 3. Low power operates in FM and CW modes. In SSB mode, TR-9000 operates on high power, independent of the HI/LOW switch.

### 3.12 TRANSMITTER PRECAUTIONS

1. The TR-9000 antenna impedance is 50 ohms. Be sure to connect an antenna of 50 ohm impedance.
2. Check the transmit frequency before operating to insure that you do not interfere with other stations.
3. By pressing the microphone PTT switch, The TR-9000 is set in transmit mode; the ON AIR lamp will light and the meter indicate transmit power. Hold the microphone about 5cm from your mouth and speak.
4. In SSB mode, microphone gain has been adjusted for optimum ALC for normal tone of voice. If you speak too loud, the signal will distort, reducing intelligibility.
5. In CW mode:
  - (1) If a key is not connected, CW is transmitted when the PTT switch is pressed.
  - (2) With a key connected, operate the key with the PTT switch depressed (or the BO-9, optional accessory) STBY SW to send.

The SIDE TONE circuit will provide a tone about 800 Hz from the speaker.

### 3.13 CW OPERATION

For CW operation, make connections as shown in Fig. 3-6.

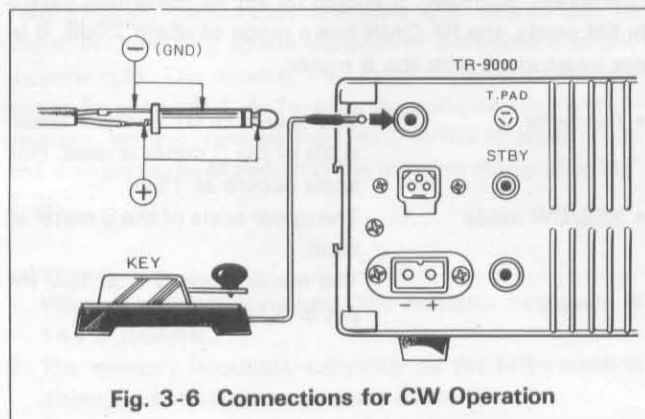

Fig. 3-6 Connections for CW Operation

### • Preparation

Connect the supplied plug to the key.

### 2. Standby switch:

- (1) The microphone PTT switch can be used.
  - (2) Connect the supplied standby plug to the STBY terminal at the rear. Your standby switch should have a contact rating of more than 100mA.
  - (3) By connecting the optional BO-9 system base, the standby switch on the BO-9 can be used.
- Use any of these 3 methods for CW operation.

### NOTE:

1. CW receive mode is USB. The AGC time constant is automatically switched to "fast" in CW mode, and to "slow" in USB mode.
2. The built-in SIDE TONE circuit allows you to monitor your station's CW signal.
3. When the key is closed, the SIDE TONE circuit provides a tone of about 800Hz even in receive mode. Use this tone as a reference for receiver tuning.

### 3.14 TONE PAD INPUT

#### TONE PAD INPUT

The TR-9000 has a 600 ohm TONE PAD input for "auto-patch" operation in FM mode.

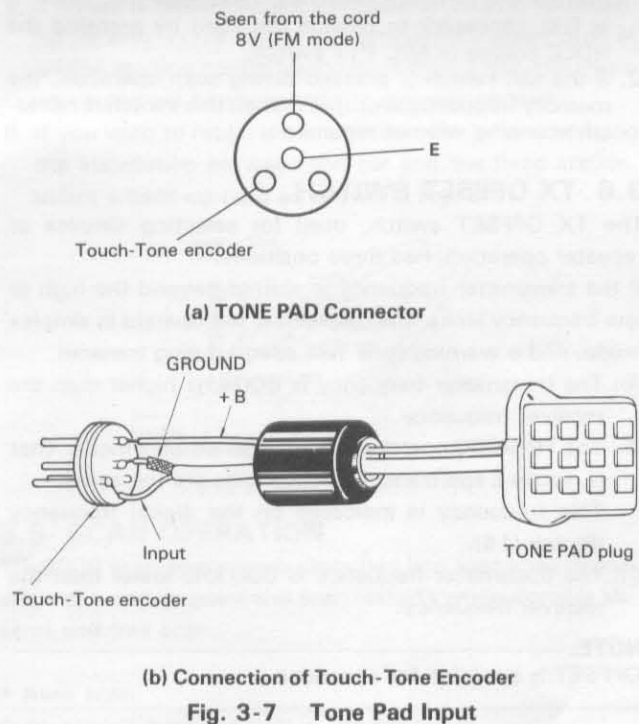

(a) TONE PAD Connector

(b) Connection of Touch-Tone Encoder

Fig. 3-7 Tone Pad Input

### NOTE:

The relationship between the displayed frequency (operating frequency) and HETERODYNE frequency in each mode is shown in the following Table. The operating fre-

# LOCK DIAGRAM

quency is set to the displayed frequency by shifting the HET frequency.

1. The digital VFO frequency shift is based on USB mode.
2. In LSB mode, there is a frequency difference of about 400–600Hz for every 10kHz as compared with USB mode. This is a product of the frequency shift and is not an indication that the transceiver is defective.
3. Consequently, the jumps when the digits shift up from 9.9 to 10.0kHz.

### 3.15 TX unit

All adjustable trimmers, coils and potentiometers of the TR-9000 are aligned and preset at the factory, and should not be touched unnecessarily.

Table 3-3

MODE	f	Displayed (operating) frequency	HET frequency
FM 1		143.90~ 148.99MHz	133.2050~ 138.2950MHz
FM 2		143.9000~ 148.9999MHz	133.2050~ 138.3049MHz
USB/CW		143.9000~ 148.9999MHz	133.2065~ 138.3064MHz
LSB		143.9000~ 148.9999MHz	133.2035~ 138.3034MHz

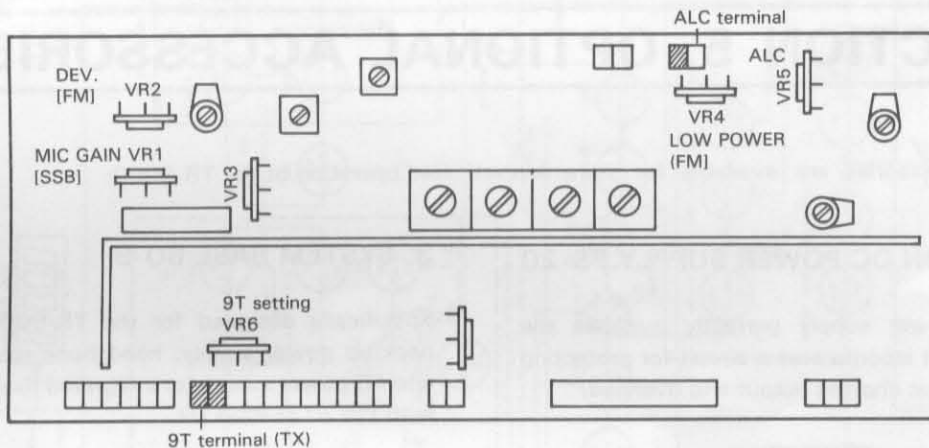

## SECTION 4. ADDITIONAL INFORMATION

### 5.1 GENERAL INFORMATION

Your TR-9000 has been factory aligned and tested to specification before shipment. Under normal circumstances, the transceiver will operate in accordance with these operating instructions.

If your transceiver fails to work, contact the authorized dealer from which you purchased it for quick, reliable repair. All adjustable trimmers and coils in your transceiver were preset at the factory and should only be readjusted by a qualified technician with proper test equipment. Attempting service or alignment without factory authorization can void the transceiver's warranty.

### 5.2 HOW THE TX FINAL TRANSISTORS ARE PROTECTED

Final transistor protection is provided by sampling the reflected power. As the reflected power is increased (higher SWR) transmitter drive is reduced, thus decreasing input to the final transistors. This in turn reduces collector loss, protecting the final transistors.

### 5.3 BATTERY PRECAUTION:

When charging your vehicle battery, or when jump-starting a dead battery ALWAYS disconnect the power lead from the back of the transceiver.

## 5.4 ORDERING SPARE PARTS

When ordering replacement or spare parts for your equipment, be sure to specify the following:

- Model and serial number of your transceiver. Schematic number of the part. Printed circuit board number on which the part is located. Part number and name, if known, and Quantity desired.

**NOTE:** \_\_\_\_\_

A full service manual is available as a separate publication.

## 5.5 SERVICE

Should it ever become necessary to return the equipment for repair, pack in its original boxes and packing, and in-

clude a full description of the problems involved. Also include your telephone number. You need not return accessory items unless directly related to the service problem. Tag all returned items with your call for easy I.D.

Please mention the model and serial number of your radio in any correspondence, whether phone or written. For future reference, record this information in the space provided on the back cover of this manual.

**NOTE:** \_\_\_\_\_

When claiming warranty service, please include a photocopy of the bill of sale, or other proof of purchase showing the date of sale.

# SECTION 5. OPTIONAL ACCESSORIES

The following accessories are available for more sophisticated operation of the TR-9000:

### 1. FIXED STATION DC POWER SUPPLY PS-20

The PS-20 DC power supply perfectly matches the TR-9000's design. It incorporates a circuit for protecting the transceiver against shorted output and overload.



### 3. SYSTEM BASE BO-9

Specifically designed for the TR-9000, it incorporates back-up power supply, headphone jack, standby switch and AC power switch for integrated fixed station operation with PS-20 or PS-120.



### 2. EXTERNAL SPEAKER SP-120

Designed for fixed station operation. Styling and tone quality match the TR-9000 perfectly.





# BLOCK DIAGRAM

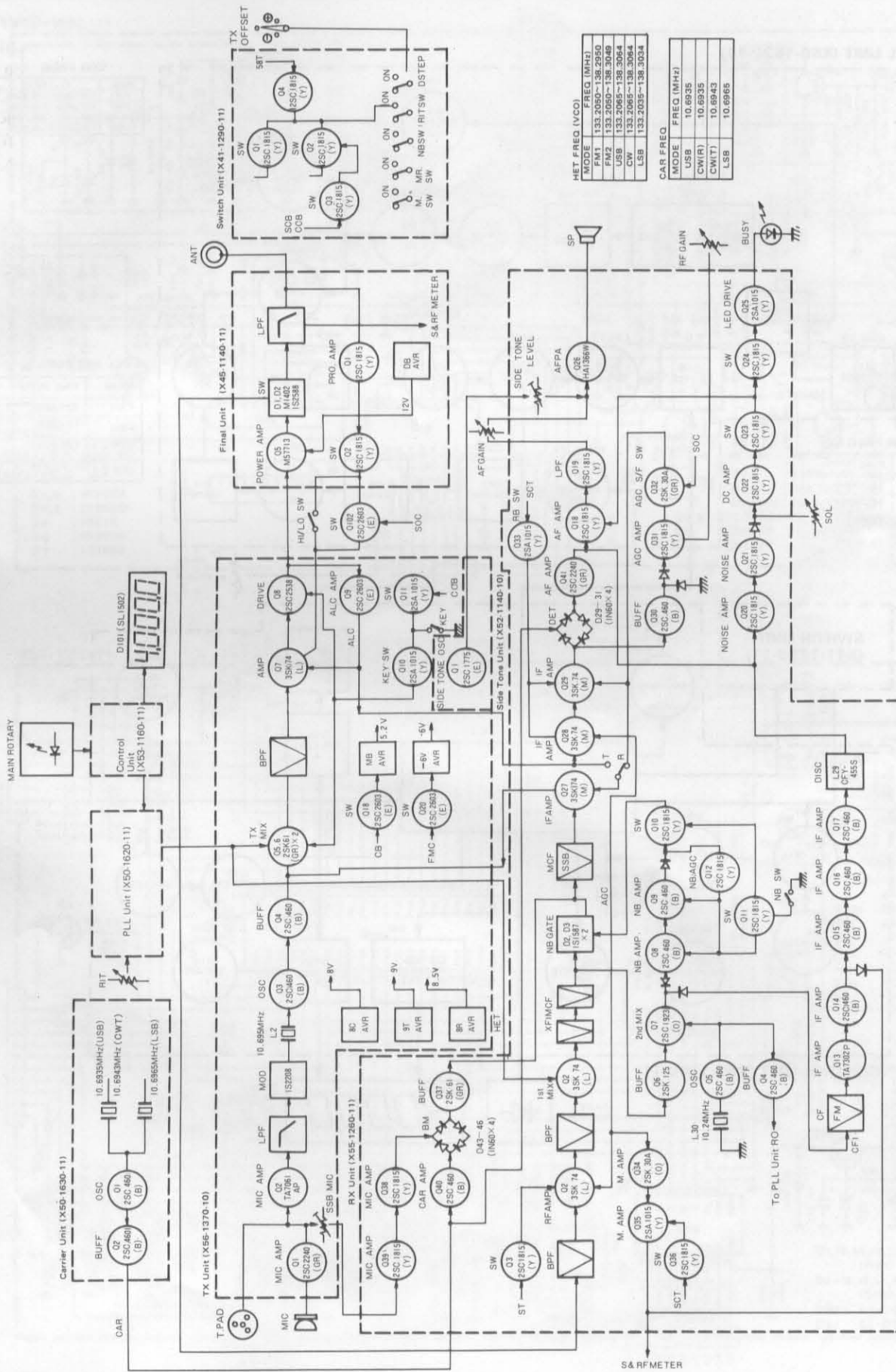

NET FREQ (VCO)	
MODE	FREQ (MHZ)
USB	133.2065-138.3049
CWIR	133.2065-138.3049
USB	133.2065-138.3064
CW	133.2065-138.3064
LSB	133.2035-138.3034

CAR FREQ	
MODE	FREQ (MHZ)
USB	10.6935
CWIR	10.6935
CWIT	10.6943
LSB	10.6965

# BLOCK DIAGRAM

## PLL UNIT (X50-1620-11)

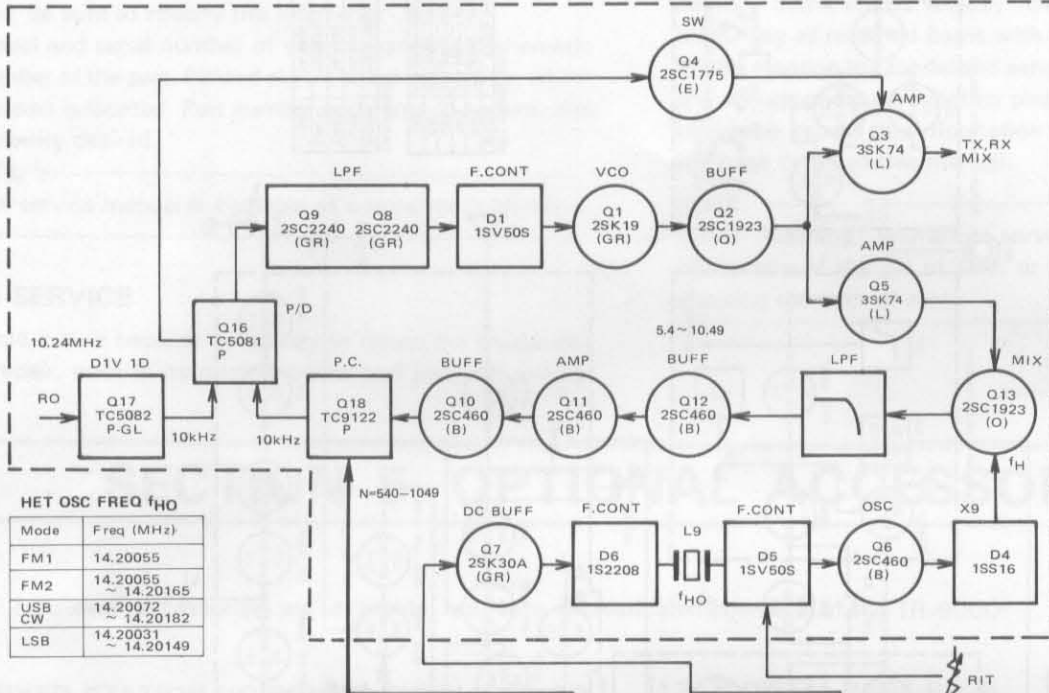

### HET OSC FREQ $f_{HO}$

Mode	Freq (MHz)
FM1	14.20055
FM2	14.20055 ~ 14.20165
USB CW	14.20072 ~ 14.20182
LSB	14.20031 ~ 14.20149

### VCO FREQ

Mode	Freq (MHz)
FM1	133.2050~138.2950
FM2	133.2050~138.3049
USB CW	133.2065~138.3064
LSB	133.2035~138.3034

### PLL HET FREQ $f_H$

Mode	Freq (MHz)
FM1	127.805
FM2	127.805 ~ 127.8149
USB CW	127.8065 ~ 127.8164
LSB	127.8035 ~ 127.8134

## SWITCH UNIT (X41-1290-11)

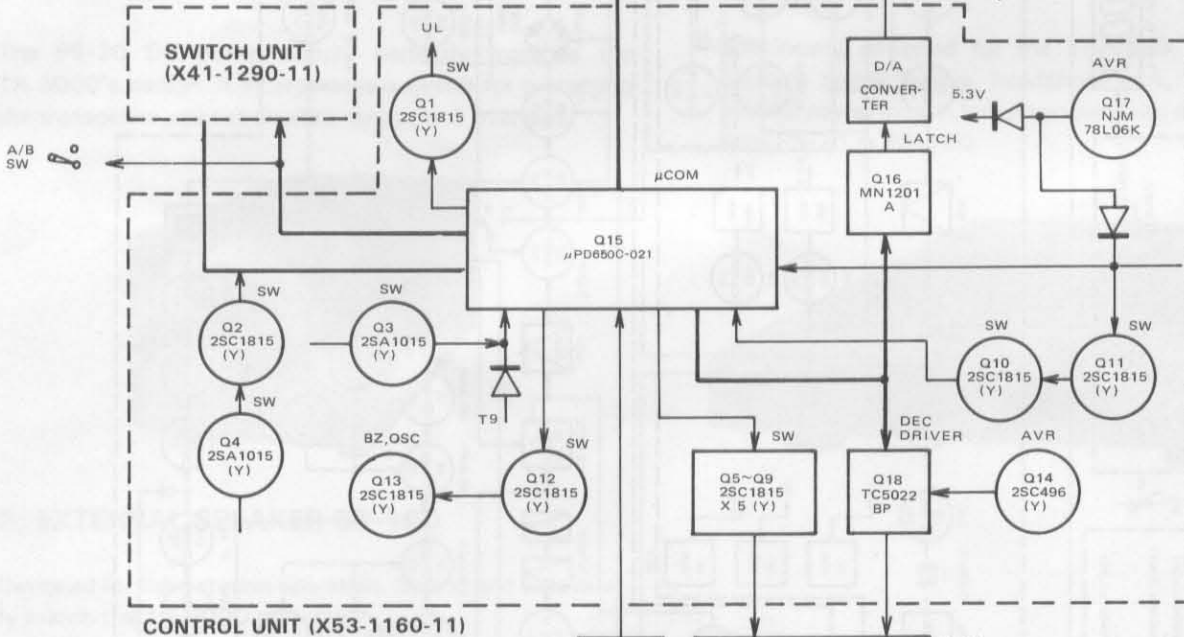

## CONTROL UNIT (X53-1160-11)



# TR-9000 SCHEMATIC

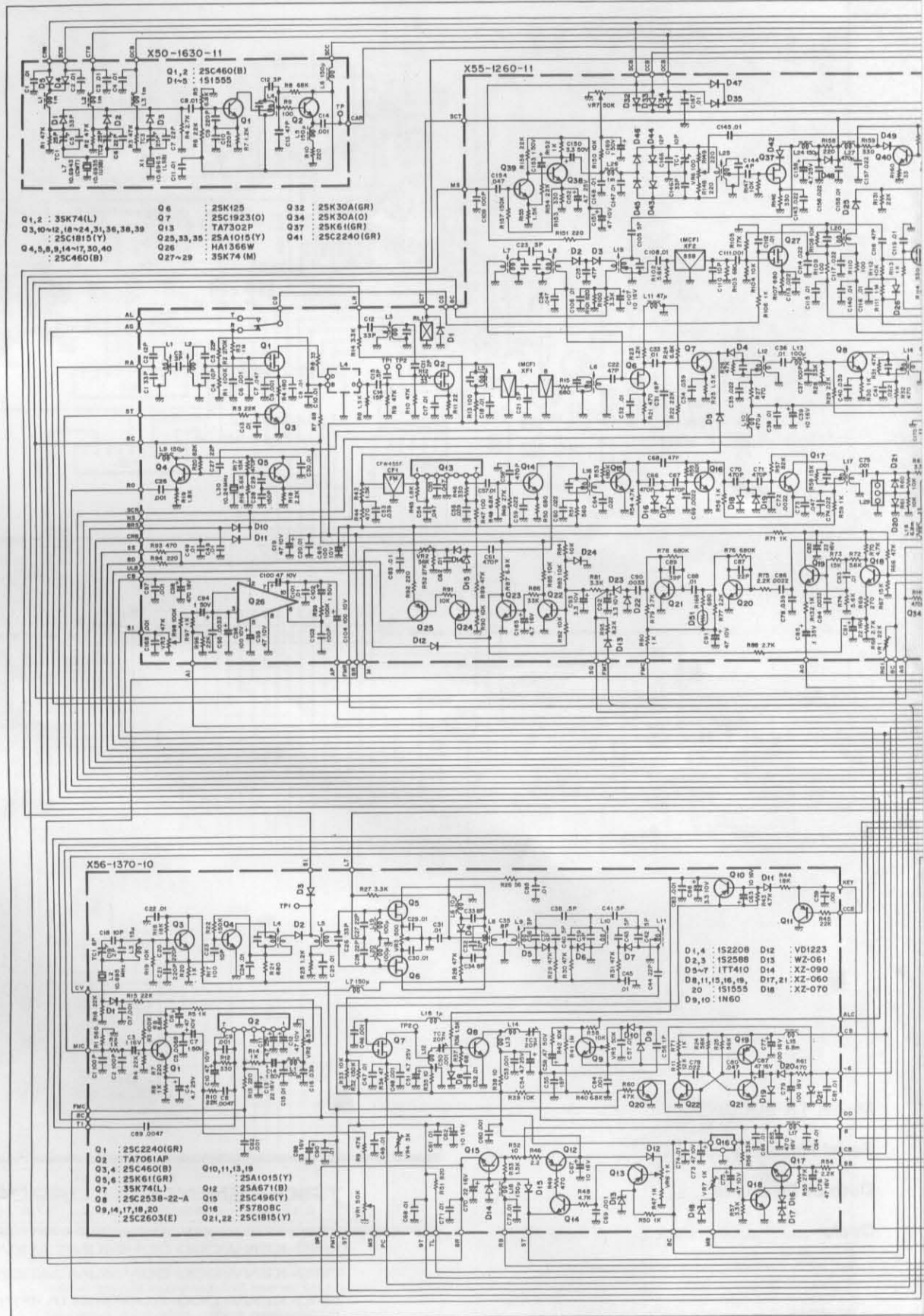

# SCHEMATIC DIAGRAM

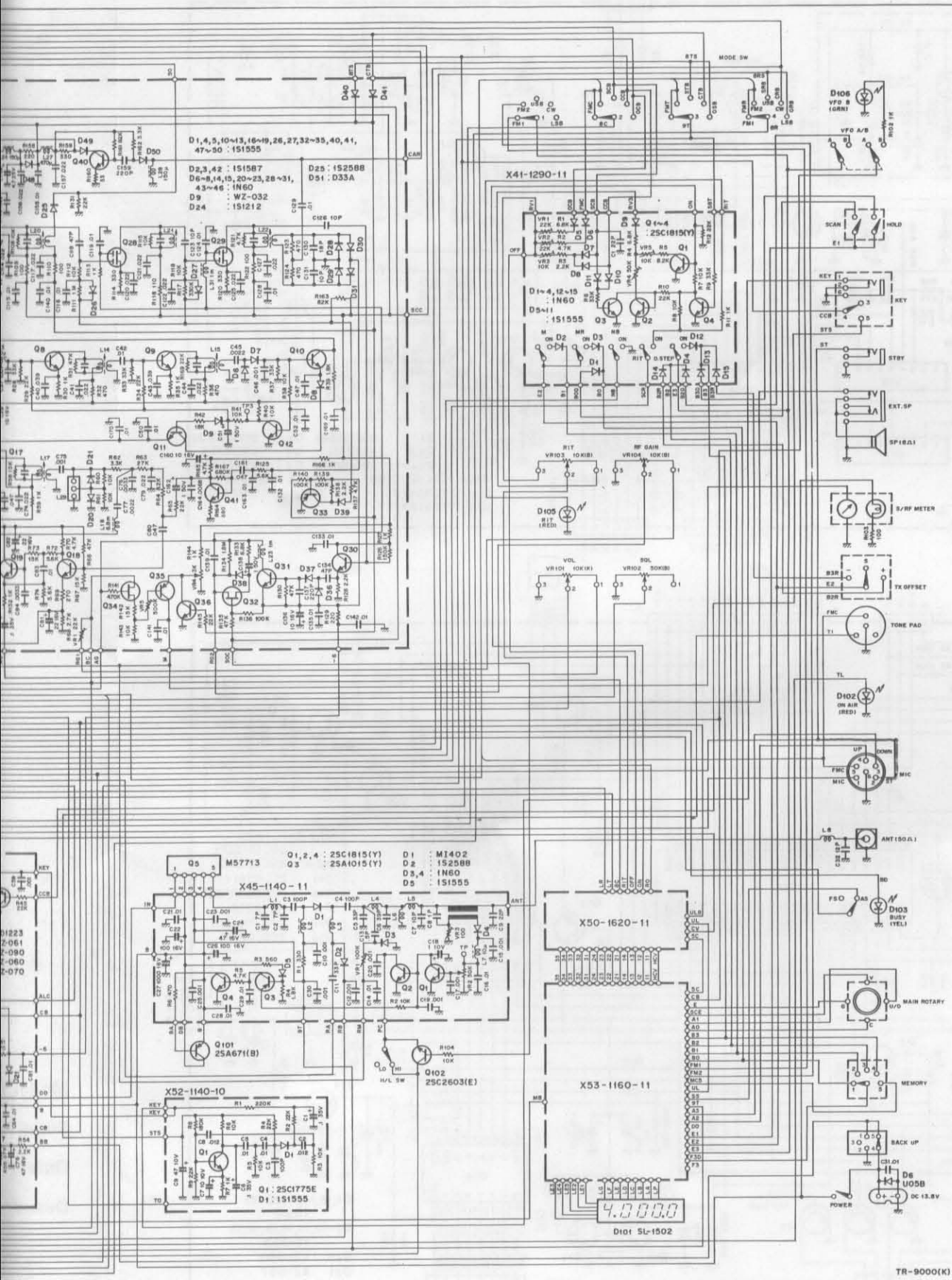

1 WHITE  
 2 BLACK  
 3 BLUE  
 4  
 5  
 6

# SCHEMATIC DIAGRAM

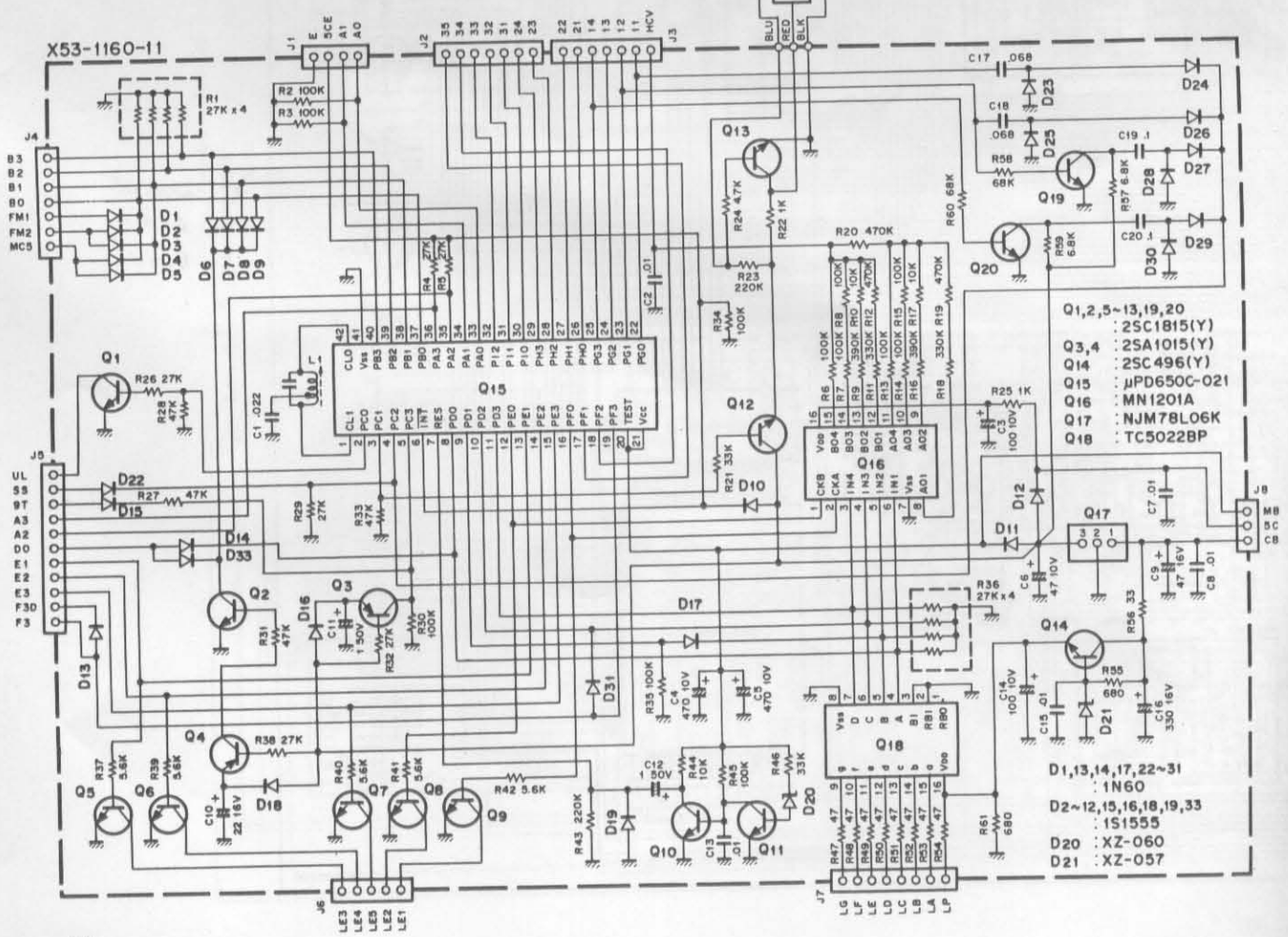
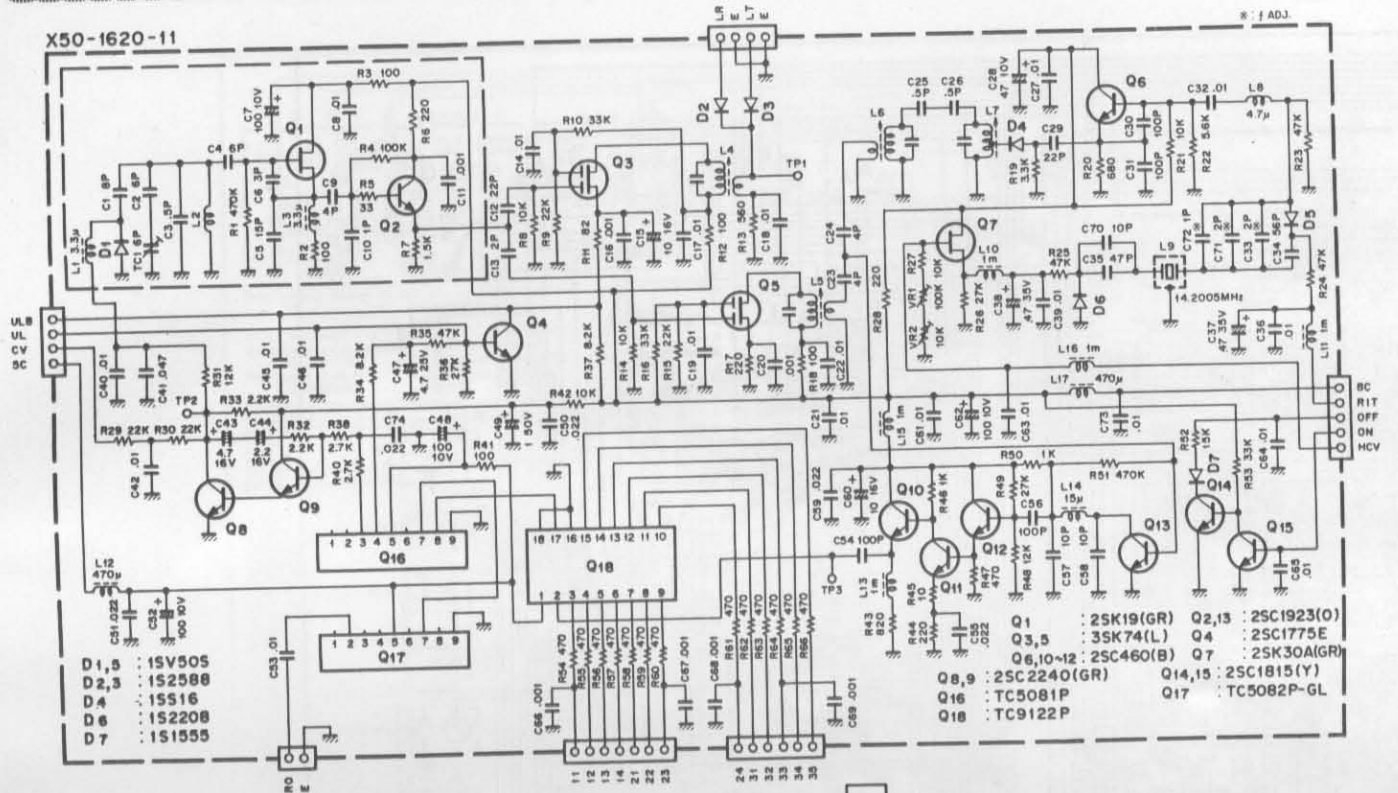

TR-9000

Model TR-9000

Serial No. \_\_\_\_\_

Date of Purchase \_\_\_\_/\_\_\_\_/\_\_\_\_

Dealer \_\_\_\_\_

\_\_\_\_\_  
\_\_\_\_\_

---

---

A product of  
**TRIO-KENWOOD CORPORATION**  
6-17, 3-chome, Aobadai, Meguro-ku, Tokyo 153, Japan

---

---

**TRIO-KENWOOD COMMUNICATIONS, INC.**  
1111, West Walnut Street, Compton, California, 90220, U.S.A.  
**TRIO-KENWOOD COMMUNICATIONS, GmbH**  
D-6374 Steinbach TS, Industriestrasse 8A, West Germany  
**TRIO-KENWOOD(AUSTRALIA)PTY. LTD.**  
30 Whiting Street, Artarmon, Sydney N.S.W. Australia 2064