

430MHz ALL MODE TRANSCEIVER  
**TR-851A/E**  
 SERVICE MANUAL

**KENWOOD**

©1987-1 PRINTED IN JAPAN  
 B51-3176-00 (O) 801



Photo is TR-851A.

## CONTENTS

CIRCUIT DESCRIPTION .....	2	MIC AMP (X59-3000-01) .....	71
ELEMENT FUNCTIONS .....	15	LCD ASS'Y (W02-03XX-05) .....	72
PARTS LIST .....	23	CONTROL UNIT (X53-1460-XX)	
EXPLODED VIEW .....	54	PC BOARD VIEWS .....	73
LEVEL DIAGRAM .....	57	CIRCUIT DIAGRAM .....	76
ADJUSTMENT .....	58	FINAL UNIT (X45-3030-XX) .....	77
TERMINAL FUNCTION .....	68	CAR UNIT (X50-3040-00) .....	78
PACKING .....	70	COMPOSITE UNIT (PLL, DRIVE, FRONT)	
PC BOARD VIEWS/CIRCUIT DIAGRAM		(X50-3050-11) .....	79
VCO (X58-1000-01) .....	71	COMPOSITE UNIT (RX) (X60-1320-01) .....	81
10.24MHz OSC (X58-3060-00) .....	71	SCHEMATIC DIAGRAM .....	83
RIT (X58-3070-00) .....	71	MU-1 (MODEM UNIT) .....	87
-6V DC-DC (X59-1100-00) .....	71	VS-1 (VOICE SYNTHESIZER) .....	89
AF PRE AMP (X59-1110-00) .....	71	TU-7 (TONE UNIT) .....	90
SQUELCH SWITCH (X59-1120-00) .....	71	BLOCK DIAGRAM .....	91
CW BREAK IN (X59-1130-00) .....	71	SPECIFICATIONS .....	BACK COVER

# TR-851A/E

## CIRCUIT DESCRIPTION

UNIT NAME	MODEL NAME	
	TR-851A (K, M)	TR-851E (T, W)
FINAL UNIT	X45-3030-11	X45-3030-51
CAR UNIT	X50-3040-00	X50-3040-00
COMPOSITE UNIT (PLL, DRIVE, FRONT)	X50-3050-11	X50-3050-11
CONTROL UNIT	X53-1460-12	X53-1460-52 (T) X53-1460-62 (W)
COMPOSITE UNIT (RX)	X60-1320-01	X60-1320-01

Table 1 TR-851A/E PC board chart

Destination	Frequency (MHz)	VFO step (kHz)		TX OFFSET DISPLAY	Repeater shift (kHz)	Tone circuit
		FM	SSB			
K, M	430.0 ~ 439.99995	25kHz	5kHz	- +	±5	1750 Tone burst
T		12.5kHz	5kHz	- +	±1.6	
W		12.5kHz	5kHz	D-A D-B	-7.6 -1.6	1750 Tone

Table 2 Frequency configuration of destination

### FREQUENCY CONFIGURATION

The TR-851A/E utilizes a PLL synthesizer system incorporating a digital VFO, which covers each band in 50Hz steps. (See Fig. 1.)

Received signals are mixed with the first local oscillator (388.585 to 398.585MHz) to produce the first intermediate frequency of 41.415MHz. In SSB or CW, the receiver operates as a double conversion system. The 10.695MHz IF signal is mixed with the second local oscillator (30.72 MHz) to produce the second intermediate frequency of 10.695MHz. The 10.695MHz IF signal is applied to crystal filter XF1 (L71-0249-05), and the signal is then applied to the ring detector to obtain the audio output.

In FM, the receiver operates as a double conversion system. The 10.695MHz signal is mixed with the PLL reference frequency of 10.24MHz to produce the second intermediate frequency of 455kHz.

The transmitter system operates as a double conversion system. In SSB mode, output from the carrier oscillator is modulated by a balanced modulator to produce an intermediate frequency signal, which is then mixed with the first local oscillator signal to produce the two meter transmit signal. The carrier oscillator circuit is controlled by the microprocessor according to the selected mode.

During USB or CW receive, the carrier oscillator frequency is 10.6935MHz. During LSB receive, it is 10.6965 MHz. During CW transmit, it is 10.6943MHz. In FM, a

10.695MHz crystal oscillator frequency is used that is directly modulated and then mixed with the first local oscillator signal.

To minimize internal heterodyne tones and spurs in the frequency generator and analysis are controlled by a microprocessor. The PLL-based frequency system consists of two PLL synthesizer loops controlled by a 4-bit high-speed microprocessor and a stable, analog RIT oscillator circuit.

Item	Rating
Nominal frequency	10.695MHz
Allowable center freq' deviation	Within ±200Hz at 6dB
Pass bandwidth and attenuation bandwidth (based on minimum loss)	2.2kHz or more at 6dB
	Within ±1.5kHz at 20dB Within ±2.4kHz at 60dB
Ripple	2dB or less
Minimum loss	5dB or less
Guaranteed attenuation	60dB or more within ±40kHz
I/O terminating impedance	1.2kΩ ±5%/6pF ±5%

Table 3 Crystal filter 10F2.2S (L71-0249-05) characteristics  
(Composit unit (RX) XF1)

## CIRCUIT DESCRIPTION

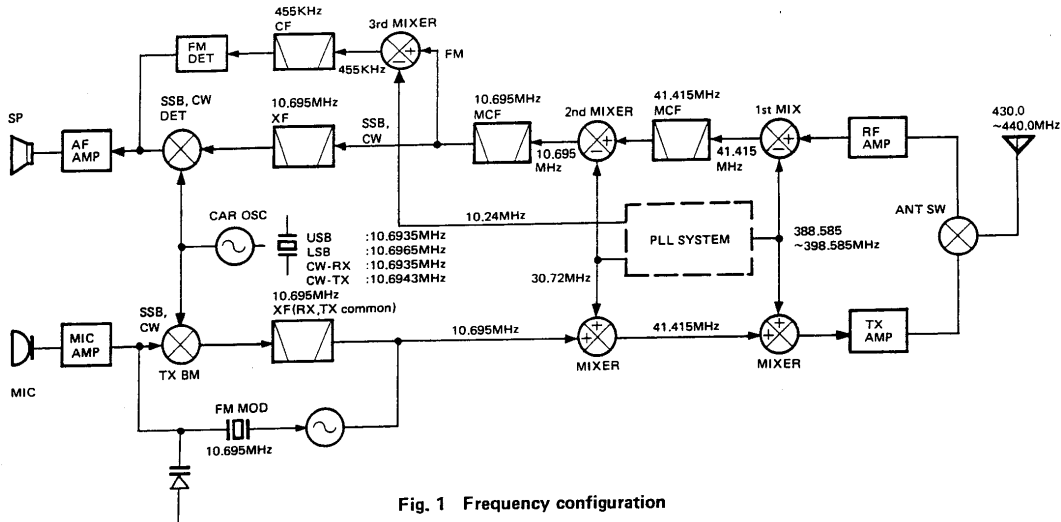

Fig. 1 Frequency configuration

## RECEIVER SYSTEM

### • General

Incoming signals from the antenna pass through a low-pass filter in the Transmitter Final unit and a diode switch (D3,D4) for transmit/receive selection. The signals then go through antenna coil (L301) and then are amplified by a GaAs FETs and junction FET (Q301, 302). Undesired signals are removed from the RF signal by a 2-pole helical resonators (L303,304) and the resulting signal is then applied to the first mixer (Q303). The signal is mixed there with the first local oscillator signal from the PLL system to produce the first IF signal of 41.415MHz. Undesirable adjacent channel signals are removed from the first IF signal by a monolithic crystal filter (MCF : XF1).

The first IF signal is then distributed to either the SSB or FM circuits.

In the SSB circuit, the first IF signal goes through noise blanker gate (D1) then amplified by a Dual Gate MOS FET (Q1) and then applied to the SSB crystal filter (XF1). The filtered signal is then amplified by the 1st IF Amplifier (Q2) and the 2nd IF Amplifier (Q3) and then applied to the ring detector (D5,D6) to obtain received audio signal.

In the FM circuit, the first IF signal is amplified by a Grounded Gate (Q4) J-FET and applied to the second mixer (Q5). The IF signal is mixed with 10.24MHz to produce the second IF signal of 455kHz. Adjacent channel interference is removed from the second IF signals by FM ceramic filter (CF1), the second IF signal is then amplified and detected by IC2 to obtain the received audio signal.

The audio signal from the SSB and FM circuits is then amplified by a common audio preamplifier Q1 (X59-1110-00). High-frequency components are removed from the audio signal by an active LPF (Q2). The audio signal is then applied to the audio volume control on the front panel. The audio signal is amplified again by audio amplifier IC201 (X50-3050-11) and then applied to the speaker.

## CIRCUIT DESCRIPTION

### ● Front end and AGC circuit

The performance of any receiver is determined largely by the performance of its front end section. Important factors which determine the performance of a receiver are sensitivity and two signal characteristics. Recently, most single mode receivers have used GaAs FETs to improve their sensitivity, while all-mode receivers used Dual Gate MOS FETs for improved AGC characteristics and RF gain control of their high frequency amplifiers. This was because, even though the AGC line was placed between the high frequency amplifier and intermediate frequency amplifier, the best way to improve the AGC characteristic had been to control the second gate of the dual-gate MOS FET. When GaAs FET's were used, such AGC characteristics had not been obtained even if the second gate was controlled by the same voltage that was used for a Dual Gate MOS FET. Fig. 2 shows the AGC Vs. gain attenuation characteristics obtained from the high frequency amplifier (MOS FET : 3SK76) and GaAs FET : 3SK184 used in a TR-9500. Since the intermediate frequency amplifier uses a MOS FET : 3SK73, almost no attenuation occurs in the high frequency amplifier even if the AGC voltage is fed directly into the GaAs FET.

Item	Rating
Nominal center frequency	41.415MHz
Pass bandwidth	±7.5kHz or more at 3dB
Attenuation bandwidth	±2.5kHz or less at 18dB
Guaranteed attenuation	20dB or more within ±1MHz except fo~fo + 300kHz spurious
Ripple	0.5dB or less
Insertion loss	1.5dB or less
Terminating impedance	4kΩ/1pF

Table 4 41.415MHz MCF (L71-0268-05) characteristics  
(Composit unit (RX) XF1)

Item	Rating
Nominal center frequency	10.695MHz
Pass bandwidth	±7.5kHz or more at 3dB
Attenuation bandwidth	±25kHz or less at 18dB
Guaranteed attenuation	30dB or more within ±1MHz 18dB or more spurious
Ripple	0.5dB or less
Insertion loss	2.0dB or less
Terminating impedance	3.0kΩ/2pF

Table 5 10.695MHz MCF (L71-0230-05) characteristics  
(Composit unit (FRONT) XF2)

Item	Rating
Nominal center frequency	455kHz±1kHz
6dB bandwidth	±6kHz or more (from 455kHz)
50dB bandwidth	±12.5kHz or less (from 455kHz)
Ripple (within 455±4kHz)	3dB or less
Insertion loss	6dB or less
Guaranteed attenuation (within 455±4kHz)	35dB or more
I/O matching impedance	2.0kΩ

Table 6 Ceramic filter CFW455F (L72-0315-05) characteristics  
(Composit unit (RX) CF1)

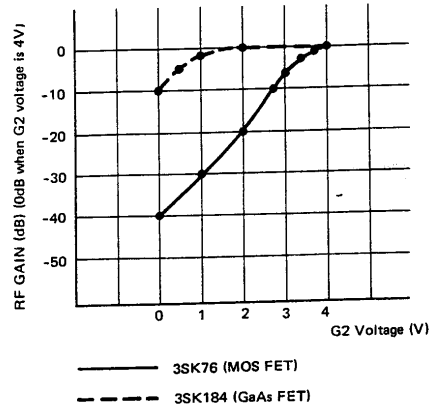

Fig. 2 AGC attenuation comparison



## CIRCUIT DESCRIPTION

The TR-851A/E AGC circuit has been designed to allow the AGC voltage to control the GaAs FET similar to the control that was obtained with the MOS FET. As shown in Fig. 3, AGC voltage from an amplifier similar to that used in previous models is fed into the intermediate frequency amplifier. The AGC voltage is approx. 4V when no signal is present. The AGC voltage is amplified by the non-DC current inversion amplifier circuit that is composed of Op Amplifier (IC3). Its output is then applied to the GaAs FET. The output voltage is set to approx. 2.5V when no signal is present, or at minimum RF gain. The AGC characteristics are shown in Fig. 4. The AGC time constant is automatically switched to slow in SSB mode or to fast in CW mode. The high sensitivity of the receiver system is thus obtained without sacrificing any two signal characteristic.

Additionally, the RF gain control, provides a convenient method of tuning out undesired signals even when receiving signals that are too strong from near by local stations.

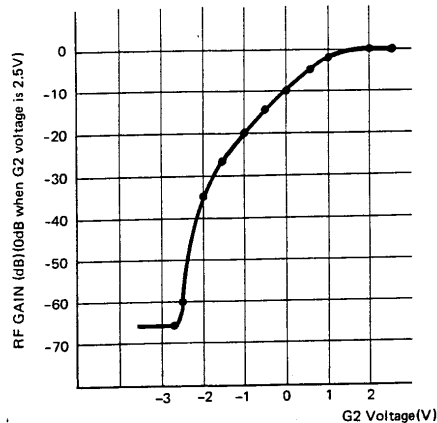

Fig. 4 AGC attenuation comparison

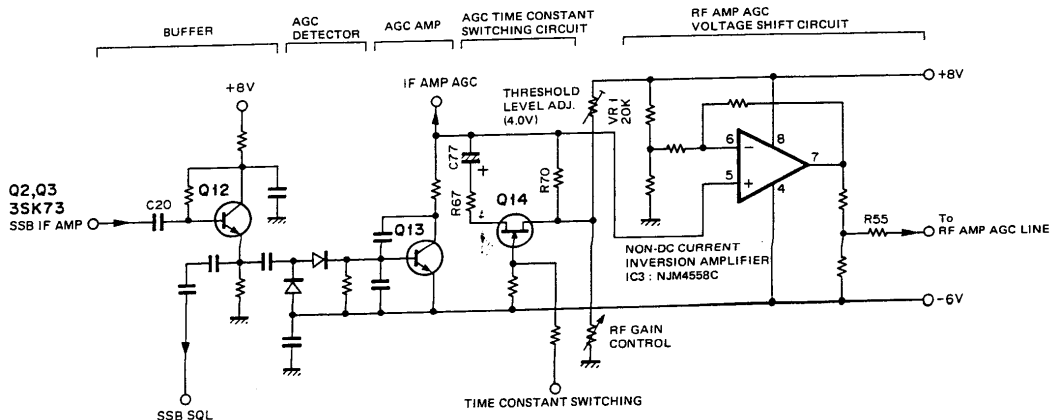

Fig. 3 AGC circuit block diagram

### SSB squelch circuit

The TR-851A/E SSB squelch circuit is a noise operated type squelch. As compared with signal type squelch, noise detection squelch may be opened even by very weak signals, such as are frequently encountered in SSB.

The high sensitivity of the squelch circuit provides advantages when receiving UHF signals from distant stations and when scanning. Generally, signal type squelch cannot surpass noise detection type in sensitivity, since they are opened by changes in the AGC voltage. It means that, to open a signal type squelch, sufficient voltage level of signal to deflect the S meter is required. The sensitivity of the TR-851A/E squelch is  $0.1\mu\text{V}$  or less (a weak signal which will not deflect the S meter.)

The squelch signal is applied to IC2 used in FM mode, through the SSB filter, SSB IF, and buffer amplifier. This IC, mixes the signal with 10.24MHz to produce 455kHz. Like the FM IF, the 455kHz signal is also amplified by IC2 and applied to the same squelch circuit as that used in FM mode. Since SSB signals do not contain carrier, unlike FM signals, the time constant circuit is switched between FM mode and SSB mode to get an appropriate response time.

## CIRCUIT DESCRIPTION

### TRANSMITTER SYSTEM

#### • General

The transmitter system operates as a double conversion system.

Audio signals from the microphone are amplified by a low-noise transistor (Q25) and applied to the SSB or FM circuits which provide approx. 26dB gain.

In SSB, the amplified signal passes through the SSB microphone gain control, and is amplified by (Q27) and applied to the balanced modulator (IC4). The balanced modulator consists of an IC that provides stable carrier suppression without being influenced by changes in temperature. Signals from the microphone amplifier are mixed with the carrier to produce a DSB signal. The DSB signal is applied to the SSB filter (with a center frequency of 10.695MHz) to produce the SSB signal.

In FM, the signal amplified by the SSB/FM common microphone amplifier (Q25) is applied through the buffer amplifier (Q26) and FM microphone gain control, and then to the pre-emphasis circuit, amplified by (IC1), and limited by Op amplifier (IC1). High frequency components are then removed from the signal by a 18dB/oct splatter filter, and the signal is sent to the FM modulation circuit.

In the FM modulation circuit, signals from the 10.695 MHz crystal oscillator circuit are directly modulated by varactor diode (D21), variable capacitor. This direct frequency modulation enables a flat transmitter frequency response to be obtained from low frequencies to high frequencies. If the frequency deviation becomes excessive, the deviation level will vary from the upper to the lower portion of the signal. The TR-851A/E is designed so that the upper and lower portions of the signal are balanced even with maximum frequency deviation.

A diode switching circuit selects either the SSB signal or the FM signal for input to the first IF amplifier (Q24), depending on the mode that has been selected. This amplifier is based on a dual-gate MOS FET circuit (Q24) and produces the 10.695 MHz first IF signal. Balanced Mixer (Q3,4) mixes the first IF signal with 30.72MHz from the PLL unit to generate the 2nd IF frequency of 41.415MHz. This signal is filtered by a bandpass filter circuit and amplified by Q5, a dual-gate MOS FET.

The 2nd IF is then mixed with the HET OSC signal from the PLL, in a diode based double-balanced mixer to yield the transmitter frequency in the 430MHz region. This signal is amplified by a bandpass amplifier circuit (Fig. 5) consisting of 3 high-Q coils that removes any spurious signals. The signal is then amplified by Q203 and Q204, and applied to the Final amplifier circuit via the DO (Drive Output) line.

Final amplifier (Q1) amplifies the DO signal to the final output power. This signal passes transmit/receive switching diodes D3 and D4, and is then filtered by a low pass filter consisting of L4 to L6 and C9 to C16. The signal is fed directly to the antenna terminal from the low pass filter. The output power is controlled by ALC voltage that is supplied to the second gate of each IF stage.

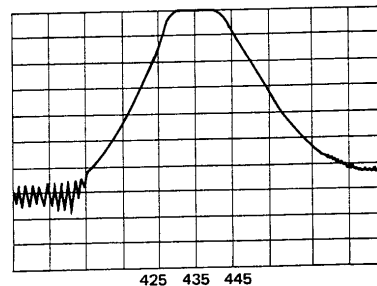

CENTER ..... 435MHz  
 FREQUENCY  
 SPAN ..... 10MHz/DIV  
 SCALE ..... 10dB/DIV

Fig. 5 TX band pass amplifier characteristics

#### • CW circuit description

In CW, the balanced modulator is unbalanced by AGC signal to allow the carrier to pass.

CW keying is performed by gates of the balanced mixer in the second IF circuit and a bias voltage is applied to the first gate of amplifier. The leading and trailing edges are smoothed to prevent key clicks.

To facilitate CW communications, the CW circuit contains CW semi break-in and side tone circuits.

The CW semi break-in circuit is a Schmitt circuit consisting of transistors (Q1-Q4) or the break-in sub assembly. The delay time can be adjusted with VR7.

The side tone circuit operates whenever the key is closed. The side tone circuit operates in modes other than CW, so key adjustment and morse code practice can be performed. Transistor (Q9) is used as the oscillator. Signals from the side tone circuit are amplified by the audio amplifier (IC1). The output frequency of approx. 800Hz can be adjusted with potentiometer (VR4).

## CIRCUIT DESCRIPTION

### • ALC and SWR protection circuits

Fig. 6 shows the ALC and SWR protection circuits. The forward power and reflected power are detected by the CM coupler (split line). The signal from the coupler is used by the ALC and SWR circuits.

A portion of the signal from the CM coupler circuit is fed to a voltage doubler that forms a portion of the ALC circuit. This generates the negative control voltage used for ALC. The greater the output power the more negative the voltage. This control voltage is amplified by Q205 and then applied to the second gate of each IF MOS FET, to control the transmitter output. This sophisticated design provides a

clean, low distortion SSB output in the TR-851A/E.

The SWR circuit uses a portion of the signal coupled from the CM coupler to sense any reflected power. The signal is amplified by Q5 and then used to control the ALC reference voltage, and thus reduce the gain of the signal applied to the final amplifier.

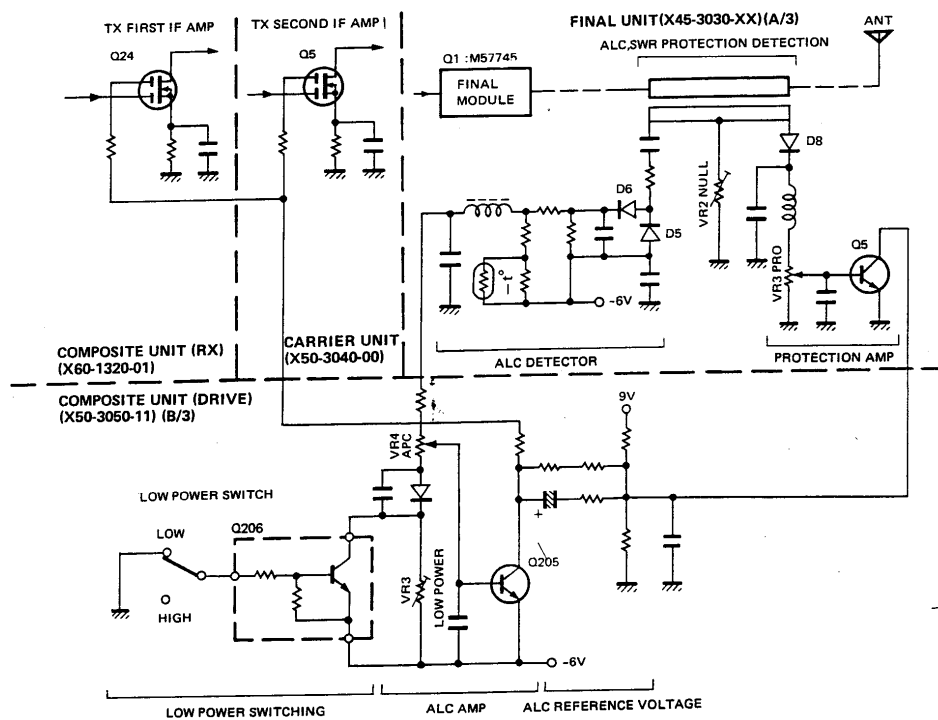

Fig. 6 ALC and SWR protection circuits

### PLL SYNTHESIZER

Fig. 7 is the PLL system block diagram.

The most important feature of the TR-851A/E PLL system is that the main loop VCO (Loop A) is composed of a sub-unit to avoid the unit being influenced by outside forces (especially vibration), which improve the frequency stability. During mobile operation in SSB or CW, this provides a great increase advantage in reliability.

The PLL system uses two loops to form a digital VFO which covers each band in 50Hz steps. Each of the loops uses a PLL IC (TC9172P) with pulse swallow type pre-scaler.

The B loop utilizes a 2.5kHz comparison frequency. The range of its VCO output frequency is from 28.6 to 27.6 MHz (frequency division ratio 11200 to 10800 : 1). The B loop VCO output is frequency divided by 50 (to produce 572 to 552kHz). Which is used to produce a signal that covers 20kHz from 9.668 to 9.688 MHz in 50Hz steps. This signal is then mixed with the reference oscillator frequency to 10.24MHz.

# TR-851A/E

## CIRCUIT DESCRIPTION

The RIT oscillator circuit utilizes a signal of 15.266MHz which is multiplied by 6 to obtain a 91.597MHz signal. The oscillator frequency can be varied within a range of  $\pm 1.2$  kHz from this center frequency by varying the voltage of the varactor diode in the oscillator. When the RIT switch is OFF, the variable capacitor voltage is fixed, because of high resistance, and the RIT oscillator operates as a stable local frequency oscillator. The RIT ON signal is detected by the microprocessor and transferred to the PLL IC containing which contains an I/O port to control the RIT switching circuit. The RIT oscillator output is mixed with a 9.668 to 9.688MHz signal to produce a local frequency range of 101.265 to 101.285MHz for loop A mixing.

The A loop uses a 20kHz comparison frequency to control loop A over a range of 10.84 to 20.84MHz to yield a VCO frequency from 112.105 to 122.105MHz (frequency division ratio 542 to 1042 : 1). To cover the entire 10MHz band in 50Hz steps, the VCO output is mixed with the local oscillator signal (101.265 to 101.285MHz).

The reference oscillator frequency of 10.24MHz produced in the sub-unit has three functions. The first is to provide a reference for loops A and B. The second uses a tuning coil to produce a local oscillator signal for the third mixer used in FM receive. The third use is to multiply the signal by three to produce the local oscillator signal (30.72 MHz) for transmitter and receiver mixing. This particular signal is multiplied by 3, two more times to yield a 276.48 MHz signal, which is mixed with the loopA output signal to yield a VFO that can cover the entire 10MHz band from 388.585 to 398.585MHz in 50Hz steps.

The 10.24MHz reference signal is also used as a local oscillator for transmit/receive mixing, which aids in PLL frequency stability.

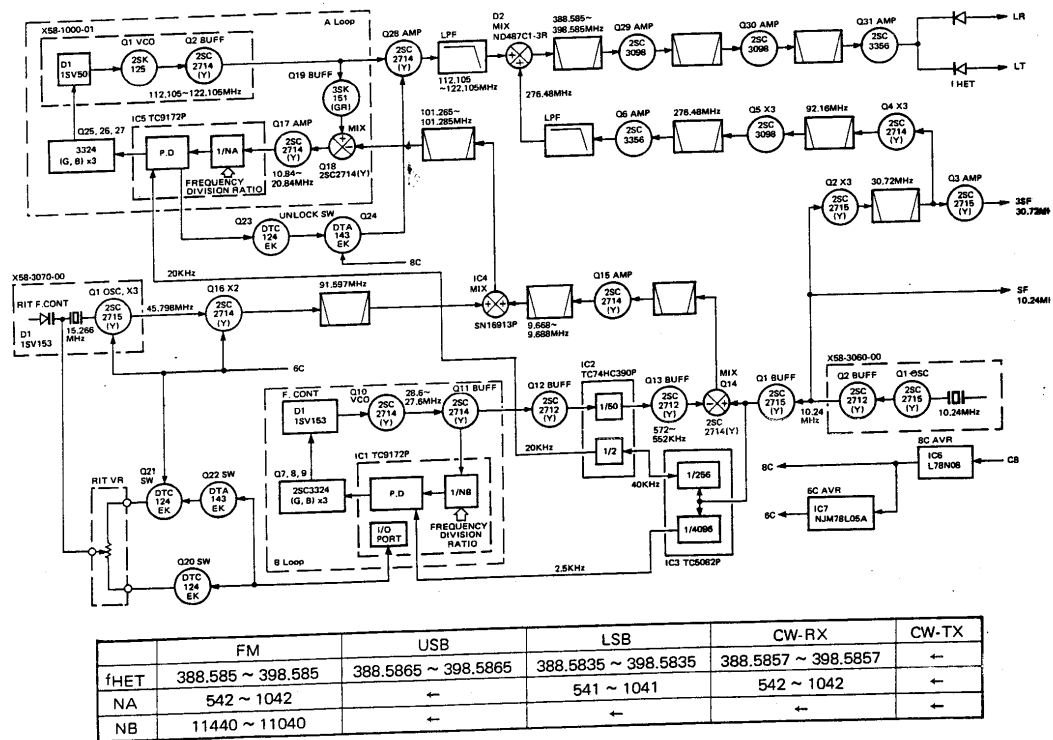

Fig. 7 PLL system block diagram

## CIRCUIT DESCRIPTION

### DIGITAL CONTROL UNIT

#### • General

The control unit consists of two PC boards : one mounted on the front panel, and the other on the main chassis. Processing is controlled by three microprocessors (MPU's).

Fig. 8 is a block diagram of the control unit. The control unit includes three MPU's, their peripheral circuitry, and input circuit (rotary encoder, keyboard, and switches), a reset/backup circuit, a mode switching circuit, and various other switching circuits.

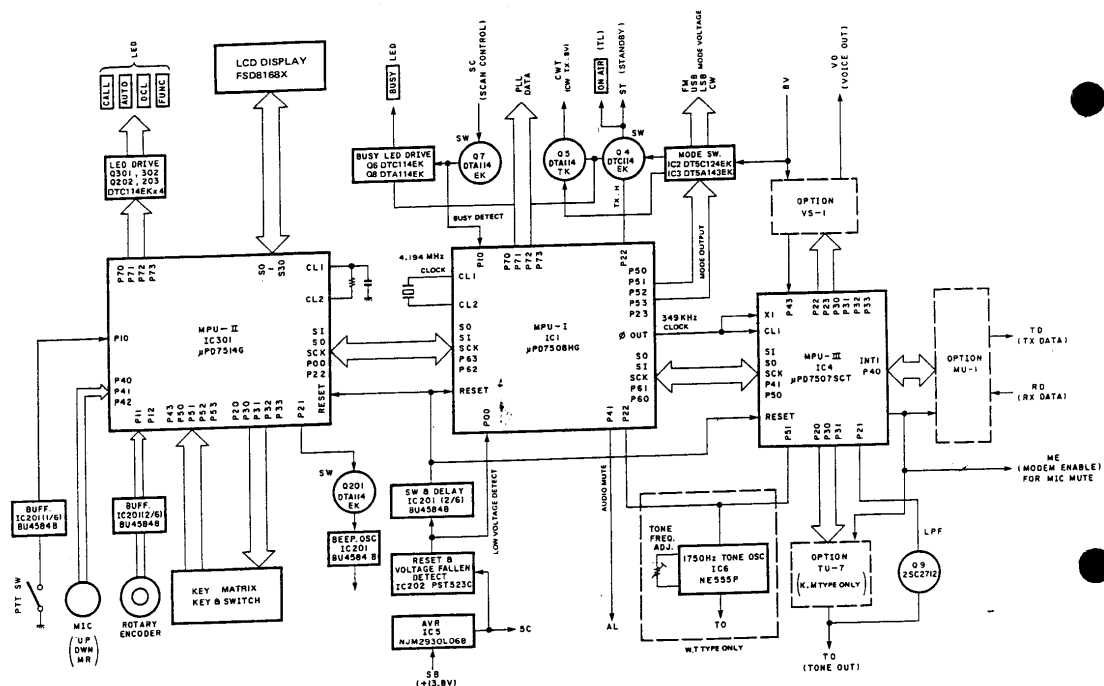

Fig. 8 Control unit block diagram

# TR-851A/E

## CIRCUIT DESCRIPTION

- **MPU interface circuits**

Fig. 9 shows how the three MPUs are interfaced. To exchange data between the MPUs, three clock and data I/O lines (SCK, SI and SO) and two each of control lines SCK, SQR, DCK, and DRQ are provided.

- **Reset backup circuit**

Fig. 9 also shows the reset backup circuit. When the transceiver power is turned on, an approx. 20ms H level pulse is sent from the reset circuit using a dedicated reset IC (IC201) to the RES line. Since the RES line is connected to all MPUs (MPU-I, MPU-II, MPU-III), the MPUs begin operation at the same time. When the power is turned off, IC202 recognizes that the voltage of the 5V line fell to 4.5V or less, and sets the low voltage fallen detect line (VFD) to a low level. The VFD signal is sent to MPU-I P00 and MPU enters the backup mode.

Output voltage from the lithium battery for backup is supplied to MPU-I and MPU-II providing backup for two MPUs.

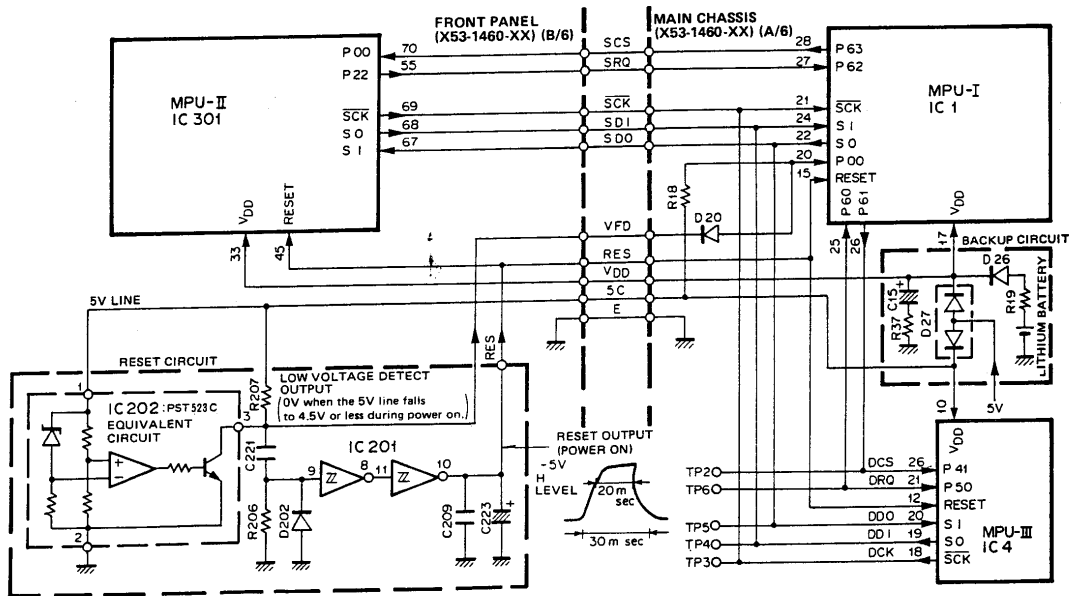

Fig. 9 Interface between MPUs and reset backup circuit

## CIRCUIT DESCRIPTION

### • Key, switch and encoder circuits

Fig. 10 shows the key, switch, and encoder input circuits. The front panel keys are arranged in a matrix and key signals are sent to MPU-II, using a key scan technique. The microphone switch lines (PTT, UP, DOWN, etc.) are connected to MPU-II through the protection diodes, CR time constant circuit, and chatter absorption circuits. The encoder is also connected to MPU-II through the CR time constant circuit and the inverter of the Schmitt trigger inputs (IC201) for chattering absorption.

MIC Pin	3	4	6
Port bit	2	1	0
Switch/Port	DWN	UP	MR
UP + DWN	0	0	0
RES	0	0	1
DOWN	0	1	0
CHL	0	1	1
UP	1	0	0
MR	1	0	1
OFF(MC-55)	1	1	0
OFF(MC-56)	1	1	1

Table 7 Microphone input logic

	P53	P52	P51	P50	P43
P20		▼/F. LOCK	▲/AL	COM/TONE	VOICE/TONE
P30				RIT	FUNC.
P31	CS	CSQ	RES	CHL	DCL
P32	1 AUTO	2 FM/LSB	3 USB/CW	4 REV	5 MR
P33	6 F.STEP	7 SCAN	8 M	9 OFFSET	φ A/B

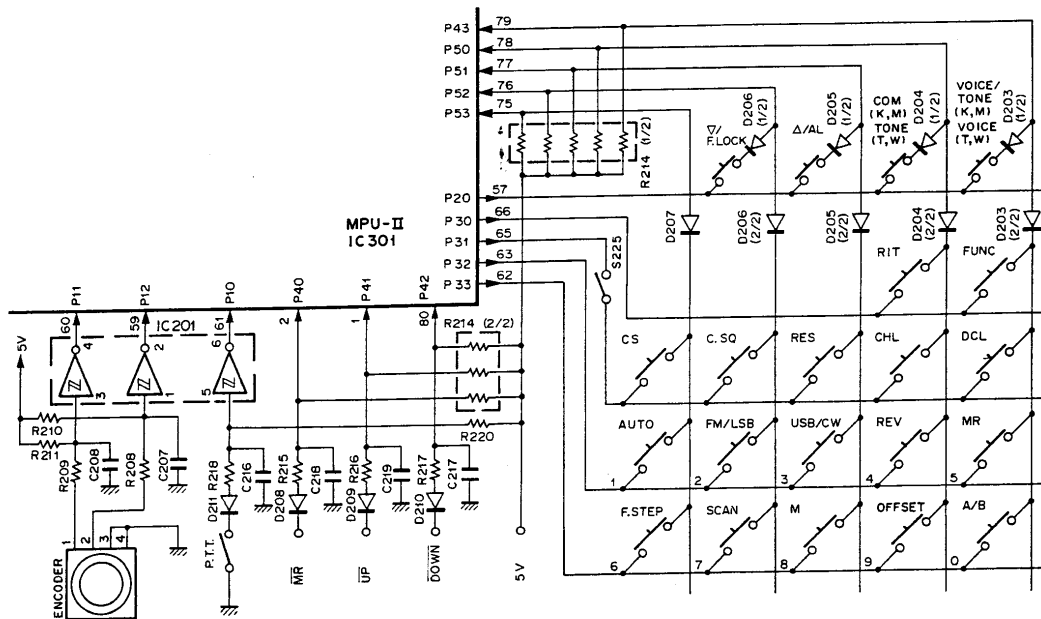

Fig. 10 Key, switch and encoder input circuit

## CIRCUIT DESCRIPTION

● **Mode voltage switching and standby circuit**

Fig. 11 shows the mode voltage switching and standby circuit. When a mode is selected with a front panel key, the corresponding port on MPU-I is set to high (5V) and an appropriate mode voltage is transmitted by switching the 8V line.

When the PTT is pressed, MPU-II sends information to MPU-I, and port P22 of MPU-I is set to H, switching Q4.

● **Other I/O circuits**

**1. Busy input circuit**

The Busy input circuit is used to determine whether the scan or DCL system has received a signal. The squelch signal from the receiver system is switched by Q7 and applied to port P10 of MPU-I. This signal also turns the BUSY indicator on, using Q6 and Q8 for switching.

**2. Audio mute output (AL)**

When checking memory channel M1, performing code squelch during alert operations, port P41 of MPU-I is set to H (5V) to mute audio output.

**3. Microphone mute output (ME)**

The ME signal is used to mute audio inputs from the microphone when the DCL system transmits a control signal. Port P53 of MPU-III is set to H (5V) to switch Q2E in the MIC input of the RX unit. This signal is also used to control a modem IC in the modem unit MU-1.

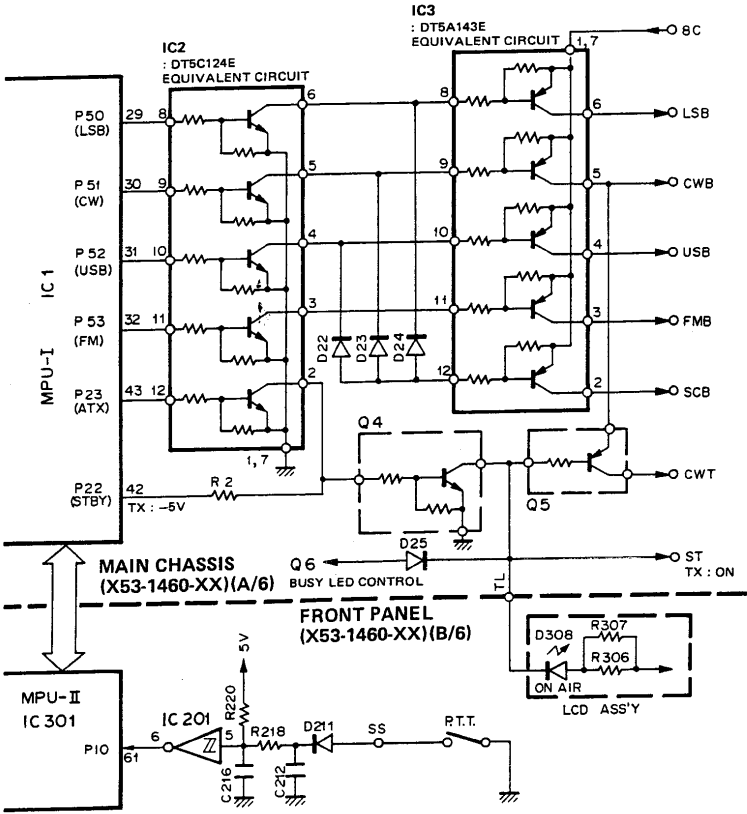

Fig. 11 MODE voltage switching and standby circuit



## CIRCUIT DESCRIPTION

### Test points

TP2	DCS	DCL Chip Select	Data line between MPU-I and MPU-II. Temporarily set to H when an MU-1 or VS-1 related operation is performed. If this line is not reset to L, MPU-III or its peripheral circuit is bad.
TP6	DRQ	DCL Request	
TP7	VFD	Voltage Fallen Detect	Detects a voltage drop in the 5V line. The voltage of this line is 5V when power is on, and 0V when power is off, or when the 5V line falls to 4.5V or less. When the voltage of this line is abnormal, the VFD line is broken, or IC201 or IC202 is faulty.
TP8			Used to monitor the your own DCL control signal through the internal speaker. To monitor it, connect this pin to TP201. Connect only when CD-10 is used.

### Microprocessor clock

IC1	$\phi$ OUT	39 pin	Sends the 349kHz produced by frequency dividing X1 (4.19MHz) by 12. This clock is supplied to CL1 of MPU-III (IC4) through C12.
IC4	CL1	13 pin	Clock input for the above pin. The 349kHz square wave can be monitored at this pin.

### Connectors

J5	VFD	Voltage Fallen Detect	Same function as TP7 above.
	VDD	Microprocessor backup voltage	Power line between MPU-I (IC1) and MPU-III (IC4). Backed up by a lithium battery when the transceiver power is off. Set to 5V when power is on, 2.5V when power is off. When the voltage drops, the battery is exhausted, or its peripheral circuit (D26 or C15) is faulty.
	RES	Reset	Reset line between MPU-I, MPU-II, and MPU-III. Supplies a 5V peak wave for approx. 20ms when power is turned on.
	SCS	Slave Chip Select	Data line between MPU-I and MPU-II. Temporarily set to H when a front panel operation is made. When this line is not reset to L, the SCS, SRQ, SCK, SDI, or SDO line is broken, or the LCD assembly may be faulty.
	SRQ	Slave Request	

Table 8 Test pins

Pin No.	Name	I/O	Function	Logic	Pin No.	Name	I/O	Function	Logic
1	P10	I	BUSY input (H : Busy, L : Open)		23	NC	-	Not used	
2	P11	I	D17 detect input		24	SI	I	Serial data input	
3	P12	I	D16 detect input		25	P60	O	DCL request (DRQ) (to IC4)	
4	P13	-	Not used (NC)		26	P61	O	DCL chip select (DCS) (to IC4)	
5	P30	-	Not used (NC)		27	P62	O	Slave request (SRQ) (to IC301)	
6	P31	O	Output for D16/D17 detection		28	P63	O	Slave chip select (SCS) (to IC301)	
7	P32	O	Tone control output 1750Hz (for W)		29	P50	O	LSB mode select output (in LSB : H)	
8	P33	-	Not used (NC)		30	P51	O	CW mode select output (in CW : H)	
9	P70	O	PLL serial data		31	P52	O	USB mode select output (in USB : H)	
10	P71	O	PLL serial clock		32	P53	O	FM model select output (in FM : H)	
11	NC	-	Not used		33	P40	-	Not used (NC)	
12	NC	-	Not used		34	P41	O	Audio mute output (in Alert search : H)	
13	P72	O	PLL A loop enable		35	P42	O	SQ select output (in open search : H)	
14	P73	O	PLL B loop enable		36	P43	-	Not used (NC)	
15	RESET	I	Reset input		37	Vss	-	GND	
16	CL1	-	Connect to oscillator		38	EVENT	-	Not used (GND)	
17	VDD	-	Power pin (5V)		39	$\phi$ OUT	O	349kHz output (To IC4)	
18	CL1	-	Connect to oscillator		40	P20	O	Output for switching diode	
19	INT 1	-	Not used (GND)		41	P21	O	Output for switching diode	
20	P00	I	Low voltage detect input (VFD)		42	P22	O	Transmit select (transmit mode : H)	
21	SCK	I	Serial clock input (SCK, DCK)		43	P23	O	Transmit disable	
22	SO	O	Serial data output (SDO, DDO)		44	NC	-	Not used	

SQ = Squelch

Table 9  $\mu$ PD7508HG-564-22 (MPU-I) pin functions (Control unit IC1)

## CIRCUIT DESCRIPTION

Pin No.	Name	I/O	Function	Logic	Pin No.	Name	I/O	Function	Logic
1	P43	I	Option VS-1 BUSY input		15	CL2	-	Not used (NC)	
2	X1	-	Not used		16	INT1	I	Model clock input (from MU-1)	
3	X2	-	Not used		17	INT0	-	Not used (GND)	
4	P20	O	Option TU-7 latch output (for K, M)		18	SCK	O	Serial clock (DCK)	
5	P21	-	Not used		19	SO	O	Serial data output (DDI)	
6	P22	O	Option VS-1 strobe output (SR)		20	SI	I	Serial data input (DDO)	
7	P23	O	PS4 Option VS-1 data output		21	P50	O	DCL request (DRQ) (to MU-1)	
8	P30	O	PS3 VS-1/TU-7 clock, data output		22	P51	-	Option TU-7 clock output (for W, T)	
9	P31	O	PS2 VS-1/TU-7 clock output		23	P52	-	Not used (NC)	
10	P32	O	PS1 Option VS-1- data output		24	P53	O	Modem enable output (to MU-1)	
11	P33	O	PS0 Option VS-1 data output		25	P40	I/O	Model data input and output (to MU-1)	
12	RESET	I	Reset input		26	P41	I	DCL chip select (DCS) (from IC1)	
13	CL1	I	349kHz clock input (from IC1)		27	P42	-	Not used (NC)	
14	VDD	-	Power pin (5V)		28	Vss	-	GND	

Table 10  $\mu$ PD7507SCT-226 (MPU-III) pin functions (Control unit IC4)

Pin No.	Name	I/O	Function	Logic	Pin No.	Name	I/O	Function	Logic	
1	P41	I	Microphone switch input		41	S4	O	Segment display output		
2	P40	I	Microphone switch output		42	NC	-	Not used		
3	X2	-	Not used (NC)		43	S3	O	Segment display output		
4	X1	-	Not used (GND)		44	S4	O			
5	VLC3	-	LCD binary voltage pin		45	S1	O			
6	VLC2	-			46	S0	O			
7	VLC1	-			47	INT1	-	Not used (GND)		
8	COM3	-	Not used (NC)		48	RESET	I	Reset input		
9	COM2	-	Not used (NC)		49	CL1	-	Connect to CR for clock oscillator		
10	COM1	O	LCD common display output		50	CL2	-	Connect to CR for clock oscillator		
11	COM0	O			51	P73	-	Not used (NC)		
12	S31	O	Not used (NC)		52	P72	O	DCL LED display output		
13	S30	O	LCD segment display output		53	P71	O	AUTO LED display output		
14	S29	O			54	P70	O	CALL LED display output		
15	S28	O			55	P22	O	Slave request (SRQ) (to IC1)		
16	S27	O			56	P21	O	Beep output (on : H)		
17	S26	O			57	P20	O	Key scan output		
18	S25	O			58	P13	-	Not used (GND)		
19	S24	O			59	P12	I	Encoder input		
20	S23	O			60	P11	I	Encoder input		
21	S22	O			61	P10	I	PTT switch input		
22	S21	O			62	P33	O	Key scan output		
23	NC	-	Not used		63	P32	O	Key scan output		
24	S20	O	LCD segment display output		64	Vss	-	GND		
25	S19	O			65	P31	O	Key scan output		
26	S18	O			66	P30	O	Key scan output		
27	S17	O			67	SI	I	Serial data input (SDO)		
28	S16	O			68	SO	O	Serial data output (SDI)		
29	S15	O			69	SCK	O	Serial clock		
30	S14	O			70	P00	I	Slave chip select (SCS) (from IC1)		
31	S13	O			71	P63	-	Not used (GND)		
32	S12	O			72	P62	-	Not used (GND)		
33	VDD	-		Power pin (5V)		73	P61	O	FUNC LED output	
34	S11	O	Segment display output		74	P60	O	LCD bias control (Nor.: L, Power off : H)		
35	S10	O			75	P63	I	Key scan input		
36	S9	O			76	P52	I			
37	S8	O			77	P51	I			
38	S7	O			78	P50	I			
39	S6	O			79	P43	I			
40	S5	O			80	P42	I	Microphone switch input		

Nor. = Normal

Table 11  $\mu$ PD7514G-143-12 (MPU-II) pin functions (LCD assembly IC301)

## ELEMENT FUNCTIONS

### FINAL UNIT (X45-3030-XX)

Element	Function	Description
Q1	Power amplifier	
Q2~Q4	Drive + B AVR	
Q5	SWR protection control	Adjustable with VR3. Normally, base voltage is 0V and collector voltage is 4.0V in TX mode. When the antenna is opened, base voltage is 0.7V and collector voltage is 1.7V.
D1	Protection against reverse power connection	A short-circuit occurs when DC power connection is reversed. If power is not turned on when correct DC power connection is made, it may be due to a burned negative DC cable.
D2	AVR temperature compensation for drive circuit	
D3,D4	Transmit/receive select	Transmit mode : On. If DC source current flows, and no transmitter output is present, either of the diodes may be faulty.
D5,D6	ALC detection	ALC, the RF output coupled with C46 and R12 in the Final unit, is rectified by D5 and D6, and supplied as a DC control voltage to the preceding circuitry.
D7	RF meter detection	Adjustable with VR1. The RF meter reads 8 at 26W.
D8	Reflected wave detection	Adjustable with VR3. 4A flows when the antenna is short-circuited.

### CAR UNIT (X50-3030-00)

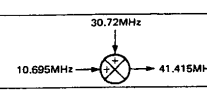
Element	Function	Description
Q1	Carrier OSC	Operates in SSB or CW mode.
Q2	Buffer amp.	Operates in SSB or CW mode.
Q3,4	Transmit mixer	Operates in the transmit mode. 
Q5	Transmit IF amp.	Operates in the transmit mode. 41.415MHz.
D1	CAR X'TAL switching	LSB transmit mode : ON (1/2), CW transmit mode : ON (1/2).
D2	CAR X'TAL switching	CW receive or USB mode : ON.

### COMPOSITE UNIT (PLL) (X50-3050-11) (A/3)

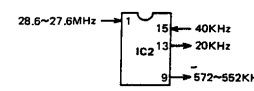
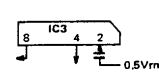
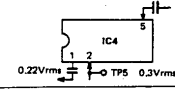
Element	Function	Description
IC1	Loop	Loop B.
IC2	Frequency divider 1/2, 1/50	<ul style="list-style-type: none"> <li>① 28.6 to 27.6MHz input.</li> <li>⑨ 572 to 552kHz output.</li> <li>⑬ 20kHz output.</li> <li>⑮ 40kHz input.</li> </ul> 
IC3	Frequency divider 1/256, 1/4096	<ul style="list-style-type: none"> <li>② input (10.24MHz).</li> <li>④ 2.5kHz output.</li> <li>⑧ 40kHz output.</li> </ul> 
IC4	Mixer	<ul style="list-style-type: none"> <li>① 101.256 to 101.285MHz output.</li> <li>② 91.597MHz input.</li> <li>⑤ 9.668 to 9.688MHz input.</li> </ul> 
IC5	PLL	Loop A
IC6	8V AVR	Input : 13.2V (CB), output : 8.1V
IC7	6V AVR	Input : 8.1V, output : 6.2V.
Q1	Buffer amp.	10.24MHz.
Q2	3 frequency multiplication	30.72MHz output.
Q3	Output amp.	30.72MHz.
Q4	3 frequency multiplication	92.16MHz output.
Q5	3 frequency multiplication	276.48MHz output.
Q6	Amp.	276.48MHz.

# TR-851A/E

## ELEMENT FUNCTIONS

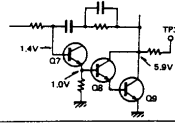
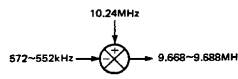
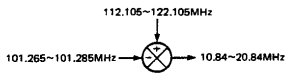
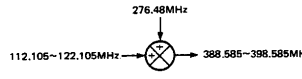
Element	Function	Description
Q7~9	Loop B PLL low-pass filter	
Q10	Loop B VCO	28.6 to 27.6MHz.
Q11,12	Buffer amp.	28.6 to 27.6MHz.
Q13	Buffer amp.	572 to 552kHz.
Q14	Mixer	
Q15	Amp.	9.668 to 8.688MHz.
Q16	2 frequency multiplication	91.597MHz output.
Q17	Loop A PLL IF amp.	10.84 to 20.84MHz.
Q18	Mixer	
Q19	Buffer amp.	112.105 to 122.105MHz.
Q20~22	RIT switching	RIT OFF : OFF, RIT ON : ON.
Q23,24	Unlock switching	LOCK ON, UNLOCK : OFF.
Q25~27	Loop A PLL low-pass filter	
Q28	Amp.	112.105 to 122.105MHz.
Q29~31	Amp.	388.585 to 398.585MHz.
D1	Loop B VCO	
D2	Mixer	
D3	Q31 idling	
D4,5	Output switching	Receive : ON.

### COMPOSIT UNIT (DRIVE) (X50-3050-11) (B/3)

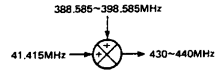
Element	Function	Description
IC201		
Q201,202	Transmit amp.	Transmit : operation, 435MHz bandwidth.
Q203	Transmit pre-amp.	Transmit : operation, 435MHz bandwidth.
Q204	Transmit driver	Transmit : operation, 435MHz bandwidth.
Q205	ALC amp.	
Q206	Transmit output select	HI : ON, LOW : OFF.
Q207	Sidetone oscillator	Approx. 800Hz.
Q208	Key detect switch	No key : OFF, Key in CW mode : ON.
Q209	Key detect switch	Q208 OFF : ON, Q208 ON : OFF.
Q210	Transmit switch	Q209 ON or KEY_DOWN : ON, Q209 OFF or KEY_UP : OFF.
D201	Transmit mixer	Transmit : operation. 
D202	Q203 idling	
D203	Q204 idling	
D204	Current reversal prevention	
D205	ALC circuit temperature compensation	
D206	Sidetone OSC circuit temperature compensation	
D207	Side tone switching	KEY DOWN : ON.
D208	Current reversal prevention	

## ELEMENT FUNCTIONS

### COMPOSIT UNIT (FRONT) (X50-3050-11) (C/3)

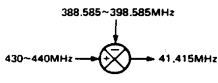
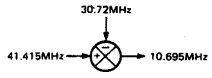
Element	Function	Description
Q301,302	RF amp.	Receive : operation.
Q303	1st mixer	Receive : operation. 
Q304	2nd mixer	Receive : operation. 
Q305,306	8R edge-rising time setting	Approx. 10ms delay.
D301	30.72MHz signal switch	Transmit : ON (carrier side 1/2), Receive : ON (front side 1/2).

### VCO (X58-1000-01)

Element	Function	Description
Q1	Loop A VCO	112.105 to 122.105MHz.
Q2	Buffer amp.	112.105 to 122.105MHz.
D1	Loop A VCO voltage control	

### 10.24MHz OSC (X58-3060-00)

Element	Function	Description
Q1	10.24MHz crystal oscillator	10.24MHz.
Q2	Voltage amp.	10.24MHz.

### RIT (X58-3070-00)

Element	Function	Description
Q1	RIT crystal oscillator	15.226MHz.
D1	RIT OSC frequency control	

### CW BREAK-IN (X59-1130-00)

Element	Function	Description
Q1	KEY DOWN detection	KEY DOWN in CW mode : ON.
Q2	Schmitt trigger circuit	KEY DOWN in CW mode : ON.
Q3	Schmitt trigger circuit	KEY DOWN in CW mode : OFF.
Q4	Transmit switching	KEY DOWN in CW mode : ON, information to microprocessors.

## ELEMENT FUNCTIONS

### CONTROL UNIT (X53-1460-XX)

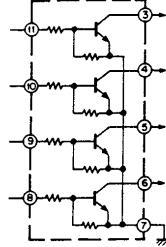
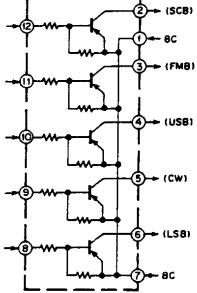
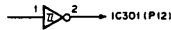
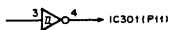
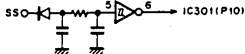
Element	Function	Description
IC1	Microprocessor I	See Circuit Description.
IC2	Mode + B switching	<p>FM mode : ③ LOW, ⑪ HI            USB mode : ④ LOW, ⑩ HI            CW mode : ⑤ LOW, ⑨ HI            LSB mode : ⑥ LOW, ⑧ HI</p> <p>When a mode is selected with a front panel key, a port (P50 to P53) corresponding to the MPU-I PC board is set to H (5V).</p> 
IC3	Mode + B switching	<p>USB, CW, LSB mode : ② + 8V, ⑫ LOW            FM mode : ③ + 8V, ⑪ LOW            USB mode : ④ + 8V, ⑩ LOW            CW mode : ⑤ + 8V, ⑨ LOW            LSB mode : ⑥ + 8V, ⑧ LOW</p> 
IC4	Microprocessor II	See Circuit Description.
IC5	5.6V AVR	
Q4	Standby switching	Transmit mode : On. The power circuit is switched.
Q5	CW transmit + B switching	CW transmit mode : On.
Q6	BUSY LED switching	Q7 On : On, Q7 Off : Off.
Q7	Scan switching	SC High : Off, SC Low : On.
Q8	BUSY LED switching	Q6 On : On, Q6 Off : Off.
D17,D18	Microprocessor port protection	
D19	Current reversal prevention	USB + LSB = SSB.
D20,D21	Microprocessor port protection	
D22	Current reversal prevention	USB mode : On. IC3 ② outputs + 8V.
D23	Current reversal prevention	CW mode : On. IC3 ② outputs + 8V.
D24	Current reversal prevention	LSB mode : On. IC3 ② outputs + 8V.
D25	Current reversal prevention	Prevents current reversal from the RX.
D26	Current reversal prevention	Prevents current from flowing to the backup battery.
D27	Current reversal prevention	Prevents backup battery current from flowing to inappropriate circuits.
D29	Microprocessor port protection	
IC201 (1/6)	Encoder rectification	Chatter absorption. 
IC201 (2/6)	Encoder rectification	Chatter absorption. 
IC201 (3/6)	Standby rectification	Chatter absorption. 

## ELEMENT FUNCTIONS

Element	Function	Description
IC201 (4/6),(5/6)	Reset pulse rectification	
IC201 (6/6)	Beeper oscillation	Approx. 1.9kHz 
IC202	Reset pulse generation	When the transceiver power is turned on, the reset circuit IC202 emits an approx. 20ms high level pulse via the RES line. 
Q201	Beeper switching	Beeper On : Off, normal : On.
Q202	DCL LED switching	DCL On : On.
Q203	FUNC LED switching	FUNC LED On : On.
D201	Current reversal prevention	
D202	Protection against negative voltage	Negative pulse absorption.
D203-D207	Current reversal prevention	Protection against key scan pulse.
D208-D211	For protection	Protection against current from the microphone pins.
D212	FUNC LED	FUNC On : On.
D213	DCL LED	DCL On : On.

### LCD ASSEMBLY (W02-03XX-05)

Element	Function	Description
IC301	Microprocessor III	See Circuit Description.
Q301	CALL LED switching	Call mode : On.
Q302	AUTO LED switching	AUTO mode : On.
D301	CALL LED	CALL mode : On.
D302	AUTO LED	AUTO mode : On.
D303	LSB LED	LSB mode : On.
D304	CW LED	CW mode : On.
D305	USB LED	USB mode : On.
D306	FM LED	FM mode : On.
D307	BUSY LED	BUSY mode : On.
D308	ON AIR LED	Transmit mode : On.

# TR-851A/E

## ELEMENT FUNCTIONS

### COMPOSITE UNIT (RX) (X60-1320-01)

Element	Function	Description
IC1	Noise amplifier for noise blanker	Amplifies 455kHz in SSB or CW mode.
IC2	FM 455kHz IF amplification and detection Squelch noise amplifier SSB squelch mixer	⑦ FM S meter output, ⑨ Detector output ⑬ Noise amplifier output ⑭ SSB IF signal input.
IC3 (1/2)	FM S meter inversion amplifier	Use VR5 to set the S meter to 0dBμ (antenna input), VR6 to set the S meter to full scale.
IC3 (2/2)	Non-inversion amplifier for RF AGC	Sets AGC voltage to approx. 2.5V at maximum RF gain settings and to approx. -3.5V at minimum RF gain settings.
IC4	For SSB balanced modulator	Carrier suppression is controlled with VR8 and VR9. ① Microphone amplifier input in SSB mode. Carrier is obtained by adding DC current to unbalance the element in the CW mode. ③ Carrier input : 10.695MHz, 0.3Vrms. ⑦ 10.695MHz DSB or CW output
IC5	8V AVR	Input : 13.2V, output : 8.1V.
Q1	SSB first IF amplifier (level 1)	Operates in SSB or CW receive mode (10.695MHz).
Q2	SSB first IF amplifier (level 2)	Operates in SSB or CW receive mode (10.695MHz).
Q3	SSB first IF amplifier (level 3)	Operates in SSB or CW receive mode (10.695MHz).
Q4	FM first IF amplifier	Operates in receive mode (10.695MHz).
Q5	FM second mixer	Operates in receive mode. 10.24MHz is used to produce 455kHz.
Q6	FM receive + B switching	FM receive mode : On.
Q7	FM receive + B switching	SSB or CW mode : On.
Q8	Noise blanker AGC	Controls IC1 gain with NB AGC in SSB or CW mode.
Q9	Noise blanker switching	*Switches NB gate when NB is on. Connector : 3.5V (FM). †Turns on when pulse noise is present.
Q10	SSB/CW receive + B switching	SSB/CW mode : On.
Q11	SSB/CW receive + B switching	SSB/CW mode : On.
Q12	AGC buffer amplifier	Operates in SSB or CW mode (10.695MHz).
Q13	AGC amplifier	Operates in SSB or CW mode (10.695MHz). AGC is amplified after being rectified by D10 and D11.
Q14	AGC time constant switching	SSB mode : On.
Q15	SSB S meter amplifier	Use VR3 for S meter zero adjustment (S-φ).
Q16	SSB S meter amplifier	Use VR4 for S meter sensitivity adjustment (S-9) : 20dB
Q17	S meter switching	SSB or CW receive mode : On (base voltage in SSB or CW mode : 7.6V). Sets FM S meter amplifier output to 0V.
Q18	For FM transmit modulation	Operates in FM transmit mode (10.695MHz). 10.695MHz output from the crystal oscillator is frequency modulated with a variable capacitor.
Q19	Buffer amplifier for FM transmit modulation	Operates in FM transmit mode (10.695MHz).
Q20	FM transmit + B switching	FM transmit mode : On.
Q21	FM transmit + B switching	SSB/CW mode : On.
Q22	SSB/CW transmit + B switching	SSB/CW transmit : On.
Q23	SSB/CW transmit + B switching	Transmit mode : On.
Q24	Transmit IF amplifier	Transmit mode : On (10.695MHz).
Q25	Microphone amplifier (level 1)	Amplifier used in all modes.
Q26	FM buffer amplifier	Use VR12 for FM microphone gain adjustment.
Q27	SSB microphone amplifier	Use VR11 for SSB microphone gain adjustment.
Q28	Microphone amplifier mute switch	Turns on when a DCL control signal is sent.

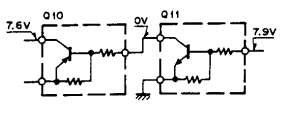
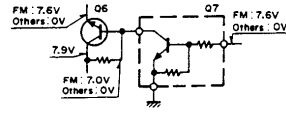



## ELEMENT FUNCTIONS

Element	Function	Description
Q29	Receive + B switching	Transmit mode : Off.
Q30	Receive + B switching	Receive mode : On.
Q31-Q33	Transmit + 9V AVR control	Operates in transmit mode. Set 9V with VR13 in transmit mode.
Q34	Amplifier for illumination + B AVR	Approx. 10.5V
Q35	Detector output switching	SSB or CW mode : On (base voltage in SSB or CW mode : 7.9V). FM detector output is set to 0V in SSB or CW mode.
Q36	Receive audio amplifier mute	Alert on and M1 search in progress in transmit mode : On. Audio output is set to 0V.
D1	Noise blanker gate	Normal : On, NB on for noise suppression : Off.
D2	Noise blanker gate	Normal : On, NB on for noise suppression : Off. Anode in SSB or CW mode : 2.9V.
D3,D4	Crystal filter switch	Switched between SSB/CW receive mode and SSB/CW transmit mode.
D5-D8	Ring detection	
D9	Current reversal prevention	
D10,D11	AGC rectification	
D12	Protection FM S meter reverse deflection	
D13	FM S meter deflection prevention in transmit mode	Operation amplifier output is forced negative in FM transmit + 8V mode.
D14	455kHz IF amplifier input switching	SSB/CW receive mode : On.
D15	Current reversal prevention	
D16	Second mixer output switching	SSB/CW receive mode : On.
D17	Second mixer output switching	FM receive mode : On.
D18	Current reversal prevention	FM receive mode : On.
D19	Noise rectifier for noise blanker	
D20	Noise blanker switching	
D21	For FM modulation	
D22	Transmit IF amplifier input switching	Switched between SSB/CW transmit mode and FM transmit mode.
D23	Current reversal prevention	
D24,D25	Carrier switching	SSB/CW transmit mode : On.
D26	Balanced modulator output switching	SSB/CW transmit mode : On.
D27	Transmit + 9V AVR temperature compensation	
D28	Current reversal prevention	
D29	For lamp AVR reference voltage	
D30	For -6V stabilization	
D31	Current reversal prevention	
D32	Squelch noise rectifier	
D33,D34	Current reversal prevention	

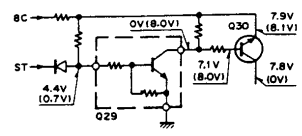

# TR-851A/E

## ELEMENT FUNCTIONS

### -6V DC-DC (X59-1100-00)

Element	Function	Description
Q1	Multi-vibrator	Supplies approx. 19kHz square wave.
Q2	Multi-vibrator	
D1	Voltage multiplying current	

### AF PRE AMP (X59-1110-00)

Element	Function	Description
Q1	Preamplifier	Squelch On : On.
Q2	Low-pass filter	

### SQL SW (X59-1120-00)

Element	Function	Description
Q1	Squelch switching	Squelch On : On.
Q2	Squelch time constant switching	
Q3	Squelch switching	Squelch On : On.
D1	Base bias setting	
D2	Current reversal prevention	Reversal prevention in SSB and CW modes.

### MIC AMP (X59-3000-01)

Element	Function	Description
IC1 (1/2)	Low-pass filter	①, ② : output.
IC1 (2/2)	Limiting amplifier	⑥ input, ⑦ output.
Q1	Tone amplifier	

## PARTS LIST

### CAPACITORS

CC 45 TH 1H 220 J  
1 2 3 4 5 6

- 1 = Type ..... ceramic, electrolytic, etc.
- 2 = Shape ..... round, square, etc.
- 3 = Temp. coefficient
- 4 = Voltage rating
- 5 = Value
- 6 = Tolerance

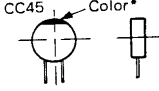

### Capacitor value

- 0 1 0 = 1pF
- 1 0 0 = 10pF
- 1 0 1 = 100pF
- 1 0 2 = 1000pF = 0.001μF

1 0 3 = 0.01μF

2 2 0 = 22pF  
1st number ↑ Multiplier  
2nd number ↑

### Temperature Coefficient

1st Word	C	L	P	R	S	T	U
Color*	Black	Red	Orange	Yellow	Green	Blue	Violet
ppm/°C	0	-80	-150	-220	-330	-470	-750

2nd Word	G	H	J	K	L
ppm/°C	± 30	± 60	± 120	± 250	± 500

Example CC45TH = -470 ± 60 ppm/°C

### Tolerance

Code	C	D	G	J	K	M	X	Z	P	No code
(%)	± 0.25	± 0.5	± 2	± 5	± 10	± 20	+ 40 - 20	+ 80 - 20	+ 100 - 0	10μF - 10~ + 50 4.7μF - 10~ + 75

Code	B	C	D	F	G
(pF)	± 0.1	± 0.25	± 0.5	± 1	± 2

Less than 10 pF

### Rating voltage

2nd word	A	B	C	D	E	F	G	H	J	K	V
0	1.0	1.25	1.6	2.0	2.5	3.15	4.0	5.0	6.3	8.0	-
1	10	12.5	16	20	25	31.5	40	50	63	80	35
2	100	125	160	200	250	315	400	500	630	800	-
3	1000	1250	1600	2000	2500	3150	4000	5000	6300	8000	-

### Chip capacitors

(EX) CC 7 3 F S L H 0 0 0 J → Refer to the above table.

1 2 3 4 5 6 7  
(Chip) (CH,RH,UJ,SL)

(EX) CK 7 3 F F 1 H 0 0 0 J

1 2 3 4 5 6 7  
(Chip) (B,F)

### Chip resistor (Carbon)

(EX) RD 7 3 E B 2 B 0 0 0 J

1 2 3 4 5 6 7  
(Chip) (B,F)

### Carbon resistor (Normal type)

(EX) RD 1 4 B B 2 C 0 0 0 J

1 2 3 4 5 6 7

- 1 = Type ..... ceramic, electrolytic, etc.
- 2 = Shape ..... round, square, etc.
- 3 = Dimension
- 4 = Temp. coefficient
- 5 = Voltage rating
- 6 = Value
- 7 = Tolerance.

### Dimension

Dimension code	L	W	T
Empty	5.6 ± 0.5	5.0 ± 0.5	Less than 2.0
E	3.2 ± 0.2	1.6 ± 0.2	Less than 1.25
F	2.0 ± 0.3	1.25 ± 0.2	Less than 1.25

### Dimension

Dimension code	L	W	T	Wattage
E	3.2 ± 0.2	1.6 ± 0.2	0.57	2B
F	2.0 ± 0.3	1.25 ± 0.2	0.45	2A

### Rating wattage

Cord	Wattage	Cord	Wattage	Cord	Wattage
2A	1/10W	2E	1/4W	3A	1W
2B	1/8W	2H	1/2W	3D	2W
2C	1/6W				

### Dimension



# TR-851A/E

## PARTS LIST

\* New Parts

Parts without Parts No. are not supplied.

Les articles non mentionnés dans le Parts No. ne sont pas fournis.

Teile ohne Parts No. werden nicht geliefert.

Ref. No.	Address	New Parts	Parts No.	Description	Destination	Remarks
参照番号	位置	新	部品番号	部品名/規格	仕向	備考
<b>TR-851A/E</b>						
1	1E		A01-1003-02	METALLIC CABINET(UPPER)		
2	4D	*	A01-1025-02	METALLIC CABINET(LOWER)		
5	1B		A20-2606-03	PANEL ASSY	K1M1	
5	1B		A20-2608-03	PANEL ASSY	T1W1	
-			A13-0666-12	MOUNTING BRACKET ASSY(R)ACSY		
-			A13-0667-12	MOUNTING BRACKET ASSY(L)ACSY		
-			A13-0668-04	MOUNTING ANGLE (ACSY)		
-			A20-2565-13	PANEL (WITH TONE)	K1M1	
-			A20-2579-13	PANEL	T1W1	
10	2C,3E		B01-0655-13	SIDE ESCUTCHEON		
11	3D		B04-0411-04	SP METAL		
-			B10-0677-04	FRONT GLASS (COM)	K1M1	
-			B10-0678-04	FRONT GLASS	T1W1	
-			B11-0434-04	REFLECTION GLASS(FUNG,DCL)		
-			B11-0439-04	FILTER (TOP)		
-			B12-0701-04	INDICATOR PLATE(MODE)		
-			B42-2424-03	LABEL (COM)	K1M1	
-			B42-2432-03	LABEL (TONE)	T1W1	
-		*	B43-1091-04	BADGE (TR-851A)	K1M1	
-		*	B43-1092-04	BADGE (TR-851E)	T1	
-		*	B43-1093-04	BADGE (TR-851E)	W1	
-			B46-0410-10	WARRANTY CARD	K1	
-		*	B50-8111-00	INSTRUCTION MANUAL		
-			E09-0471-05	4P PLUG (ACSY)		
-			E30-2053-05	DC CORD (ACSY)		
-		*	E31-3221-25	CONNECTOR WITH CABLE		
31	3D		F20-0520-04	INSULATING BOARD(SPEAKER)		
-			F05-2036-05	FUSE (20A)		
-			F05-8021-05	FUSE (8A) ACSY		
-			F20-0521-04	INSULATING BOARD(B)LITHUM BATT		
32	2D		G02-0569-04	GND SPRING		
36	1A,1B		G01-0818-04	COILED SPRING		
37	3C		G02-0505-05	KNOB FITING SPRING		
39	1D		G10-0626-04	FELT		
40	3D		G10-0643-04	FELT		
42	4D		G16-0508-04	ANTI-VIBRATIVE (SPEAKER)		
-			G02-0550-04	GND SPRING		
-			G13-0823-04	CUSHION (MOUNTING ANGLE)ACSY		
-			G53-0515-04	FELT		
-			H01-8047-03	ITEM CARTON BOX	K1M1	
-			H01-8049-03	ITEM CARTON BOX	W1T1	
-			H10-2501-03	POLYSTYRENE FOAMED FIXTURE(TOP)		
-			H10-2624-12	POLYSTYRENE FOAMED FIXTURE		
-			H13-0808-04	PROTECTION PLATE		
-			H25-0029-04	PROTECTION BAG (SCREW ETC)		
-			H25-0103-04	PROTECTION BAG (MIC,MNT ANGLE)		
-			H25-0106-04	PROTECTION BAG		
-			H25-0116-04	PROTECTION BAG (ACSY)		
-			H25-0117-04	PROTECTION BAG (DC CORD,ETC)		
60	3E	*	J32-0901-04	ROUND (BSS)		
61	2D	*	J32-0902-04	ROUND (BSS)		
64	3D		J21-1144-34	SP MOUNTING HARDWARE		

E: Scandinavia & Europe K: USA P: Canada W: Europe

U: PX(Far East, Hawaii) T: England M: Other Areas

UE: AAFES(Europe) X: Australia

△ indicates safety critical components.

## PARTS LIST

× New Parts

Parts without Parts No. are not supplied.

Les articles non mentionnés dans le Parts No. ne sont pas fournis.

Telle ohne Parts No. werden nicht geliefert.

Ref. No. 参照番号	Address 位置	New Parts 新	Parts No. 部品番号	Description 部品名 / 規格	Desti- nation 仕向	Re- marks 備考
65	1B		J29-0407-04	SW GUIDE (1-0)		
66	1B		J29-0409-04	SW GUIDE		
67	2C, 3D		J42-0449-05	BUSHING (PANEL)		
-			J02-0439-05	FOOT (ACSY)		
-			J19-1346-04	MIC HOOK (ACSY)	K1	
-			J61-0307-05	WIRE BAND		
71	3C		K21-0780-03	KNOB (MAIN)		
72	3C		K23-0783-04	KNOB (VOL, RIT)		
73	1A		K27-0482-03	KNOB (BUTTON) 1		
74	1A		K27-0483-03	KNOB (BUTTON) 2		
75	1A		K27-0484-03	KNOB (BUTTON) 3		
76	1A		K27-0485-03	KNOB (BUTTON) 4		
77	1B		K27-0486-03	KNOB (BUTTON) 5		
78	1A		K27-0487-03	KNOB (BUTTON) 6		
79	1A		K27-0488-03	KNOB (BUTTON) 7		
80	1A		K27-0489-03	KNOB (BUTTON) 8		
81	1A		K27-0490-03	KNOB (BUTTON) 9		
82	1A		K27-0491-03	KNOB (BUTTON) 0		
83	1A, 1B		K29-3044-05	KNOB		
84	1A		K29-3045-05	KNOB (FUNC)		
85	3C		K29-3046-04	KNOB (SQ, RF GAIN)		
86	3C		K29-3047-04	KNOB RING		
-			N09-0008-04	HEX. HEAD SCREW (ACSY)		
-			N09-0632-05	TAPTITE SCREW A (ACSY)		
-			N09-0633-05	TAPTITE SCREW (ACSY)	K1	
-			N14-0510-04	FLANGE NUT (ACSY)		
-			N15-1040-49	FLAT WASHER (MNT ANGLE)		
-			N15-1060-46	FLAT WASHER (ACSY)		
-			N16-0060-46	SPRING WASHER (ACSY)		
-			N99-0304-04	HEX HEAD SCREW (MNT ANGLE)		
A	2C, 3E		N09-0666-05	BIND SCREW (CAR UNIT ETC)		
B	3C, 3D		N09-0700-04	BIND SCRW (FRONT PANEL)		
C	2A		N32-2004-46	FLAT BINDING SCREW (CONT UNIT)		
D	2D, 2E		N32-3006-46	FLAT BINDING SCREW (HEAT SINK)		
E	4D		N33-3006-45	OVAL HEAD MACHINE SCREW (SPKR)		
F	1B, 2B		N35-2005-46	BINDING SCREW (SW UNIT)		
G	2D, 3D		N87-2605-46	BRAZIER SCREW (RX UNIT, ETC)		
H	1D, 4E		N35-2604-46	BINDING SCREW (PLL, CAR UNIT)		
J	2C, 4D		N89-3006-45	BINDING SCREW (CASE, ETC)		
-			S50-1406-05	TACT SWITCH		
93	3D		T07-0241-05	LOUDSPEAKER (FULL RANGE)		
-			T91-0357-15	MICROPHONE		
97	2D		W01-0401-05	WRENCH		
-			W09-0326-05	LITHIUM BATTERY (BR2032)		
99	4E	*	X50-3040-00	CAR UNIT		
100	3A, 2E	*	X45-3030-11	FINAL UNIT	K1M1	
100	3A, 2E	*	X45-3030-51	FINAL UNIT	T1W1	
101	2B, 2D	*	X53-1460-12	CONTROL UNIT	K1M1	
101	2B, 2D	*	X53-1460-52	CONTROL UNIT	T1	
101	2B, 2D	*	X53-1460-62	CONTROL UNIT	W1	
102	2D, 3D	*	X50-3050-11	COMPOSITE UNIT (PLL, DRIVE, FRONT)		

E: Scandinavia & Europe K: USA P: Canada W: Europe

U: PX (Far East, Hawaii) T: England M: Other Areas

UE: AAFES (Europe) X: Australia

△ indicates safety critical components.

# TR-851A/E

## PARTS LIST

× New Parts  
 Parts without Parts No. are not supplied.  
 Les articles non mentionnés dans le Parts No. ne sont pas fournis.  
 Teile ohne Parts No. werden nicht geliefert.

Ref. No. 参照番号	Address 位置	New Parts 新	Parts No. 部品番号	Description 部品名 / 規格	Desti- nation 仕 向	Re- marks 備考
103	3D	*	X60-1320-01	COMPOSITE UNIT(RX)		
<b>FINAL UNIT (X45-3030-XX) -11 : TR-851A -51 : TR-851E</b>						
110	3B		B42-2426-04	LABEL		
C1			C90-0875-05	ELECTRO 100UF 16WV		
C2			CK73FB1H102K	CHIP C 1000PF K		
C3			C90-2039-05	ELECTRO 15UF 16WV		
C4			CK73FB1H102K	CHIP C 1000PF K		
C5			C90-0871-05	ELECTRO 220UF 16WV		
C6			CK73FB1H102K	CHIP C 1000PF K		
C7			CM73F2H020C	CHIP C 2.0PF C		
C8			CC45SL2H040C	CERAMIC 4.0PF C		
C9			CC45SL2H030C	CERAMIC 3.0PF C		
C10			CM73F2H150J	CHIP C 15PF J		
C11			CC45SL2H120J	CERAMIC 12PF J		
C12			CM73F2H220J	CHIP C 22PF J		
C13			CC45SL2H040C	CERAMIC 4.0PF C		
C14			CM73F2H160J	CHIP C 16PF J		
C15			CC45SL2H060D	CERAMIC 6.0PF D		
C16			CC45SL2H030C	CERAMIC 3.0PF C		
C17			CS15E1VR47M	TANTAL 0.47UF 35WV		
C18	-22		CK73FB1H102K	CHIP C 1000PF K		
C23			CK45B1H102K	CERAMIC 1000PF K		
C24			CC45CH1H050C	CERAMIC 5.0PF C		
C25	-44		CK73FB1H102K	CHIP C 1000PF K		
C46			CK73FB1H102K	CHIP C 1000PF K		
112	3B,2E		E30-2021-35	DC CABLE		
-			E31-2108-05	CONNECTING WIRE(D8)		
-			E31-3186-00	CONNECTING WIRE KIT(B)REMOTE		
-		*	E31-3215-15	CONNECTING WIRE(RA)		
J1			E40-3241-05	PIN CONNECTOR (6P)		
J2			E40-3239-05	PIN CONNECTOR (4P)		
J3	3B		E11-0401-05	EAR PHONE JACK (EXT. SP)		
J4	3A		E11-0424-05	PHONE JACK (KEY)		
J5	3B		E04-0162-25	ANT RECEPTACLE (N TYPE)	T1W1	
J5	3B		E04-0164-05	ANT RECEPTACLE (M TYPE)	K1M1	
J6	3B		E08-0471-05	4P CONNECTOR		
TP1			E23-0401-05	TERMINAL		
115	3B,2E	*	F01-0951-05	HEAT SINK		
-			F05-8021-05	FUSE (8A)		
118	3B		J41-0017-05	BUSHING		
-			J61-0307-05	WIRE BAND		
L1			L34-1040-05	COIL (5.1T)		
L2			L34-0908-05	COIL (3.9.5T)		
L3			L34-1019-05	COIL (3.2.5T)		
L4			L34-1032-05	COIL (3.3.5T)		
L5			L34-1113-05	COIL (3.1.5T)		
L6			L34-1040-05	COIL (5.1T)		
L7			L40-1092-16	SMALL FIXED INDUCTOR(1UH)		
L8			L40-1092-14	SMALL FIXED INDUCTOR(1UH)		
L9			L40-1092-16	SMALL FIXED INDUCTOR(1UH)		
N	3A		N09-0623-04	SEMUS SCREW		

E: Scandinavia & Europe K: USA P: Canada W: Europe

U: PX(Far East, Hawaii) T: England M: Other Areas

UE: AAFES(Europe) X: Australia

⚠ indicates safety critical components.

## PARTS LIST

\* New Parts  
 Parts without Parts No. are not supplied.  
 Les articles non mentionnés dans le Parts No. ne sont pas fournis.  
 Teile ohne Parts No. werden nicht geliefert.

Ref. No. 参照番号	Address 位置	New Parts 新	Parts No. 部品番号	Description 部品名 / 規格	Desti- nation 仕 向	Re- marks 備考
P	3B		NB7-3008-41	BRAZIER HEAD TAPTITE SCREW		
Q	3A		NO9-0626-04	SEMUS SCREW		
R1			RD14BB2E151J	RD 150 J 1/4W		
R2			RK73FB2A472J	CHIP R 4.7K J 1/10W		
R3			RK73FB2A182J	CHIP R 1.8K J 1/10W		
R4			RK73FB2A561J	CHIP R 560 J 1/10W		
R5			RD14DB2H181J	SMALL-RD 180 J 1/2W		
R6			RK73FB2A473J	CHIP R 47K J 1/10W		
R7			RK73FB2A822J	CHIP R 8.2K J 1/10W		
R8			RK73FB2A472J	CHIP R 4.7K J 1/10W		
R9			RK73FB2A103J	CHIP R 10K J 1/10W		
R10			RK73FB2A104J	CHIP R 100K J 1/10W		
R11			RK73FB2A472J	CHIP R 4.7K J 1/10W		
R12			RK73FB2A101J	CHIP R 100 J 1/10W		
VR1			R12-4417-05	TRIMMING P8T. (51K)		
VR2			R12-0434-05	TRIMMING P8T. (100)		
VR3			R12-3455-05	TRIMMING P8T. (10K)		
RY1			SS1-1428-05	RELAY		
D1			DSA3A1	DIODE		
D2			1SS181	CHIP DIODE		
D3			MI407	DIODE		
D4			MI308	DIODE		
D5	-8		1SS101	DIODE		
D9			1SS181	CHIP DIODE		
D10			MTZ6.2JA	ZENER DIODE		
Q1			M57745	POWER MODULE		
Q2			2SA1307(Y)	TRANSISTOR		
Q3			2SC2458(Y)	TRANSISTOR		
Q4			2SA1162(Y)	CHIP TRANSISTOR		
Q5			2SC2458(Y)	TRANSISTOR		
TH1			112-502-2	TERMISTOR (5K)		
<b>CAR UNIT (X50-3040-00)</b>						
-		*	A11-0403-03	SUB CHASSIS ASSY		
C1	.2		CK73FB1H102K	CHIP C 1000PF K		
C3	.4		CK73FB1H103K	CHIP C 0.010UF K		
C5			CC73FCH1H220J	CHIP C 22PF J		
C6			CK73FB1H103K	CHIP C 0.010UF K		
C7			CC73FCH1H180J	CHIP C 18PF J		
C8			CC73FCH1H390J	CHIP C 39PF J		
C9	.10		CK73FB1H103K	CHIP C 0.010UF K		
C11	.12		CC73FCH1H151J	CHIP C 150PF J		
C13			CC73FCH1H220J	CHIP C 22PF J		
C14			CC73FCH1H020C	CHIP C 2.0PF C		
C15	-17		CK73FB1H103K	CHIP C 0.010UF K		
C18	-21		CK73FB1H102K	CHIP C 1000PF K		
C22			CK73FB1H103K	CHIP C 0.010UF K		
C23			CC73FCH1H080D	CHIP C 8.0PF D		
C24			CK73FB1H103K	CHIP C 0.010UF K		
C25			CC73FSL1H101J	CHIP C 100PF J		
C26	-28		CK73FB1H103K	CHIP C 0.010UF K		
C29	.30		CK73FB1H102K	CHIP C 1000PF K		
C31			CC73FCH1H120J	CHIP C 12PF J		
C32			CC73FCH1H0R5C	CHIP C 0.5PF C		

E: Scandinavia & Europe K: USA P: Canada W: Europe  
 U: PX(Far East, Hawaii) T: England M: Other Areas  
 UE: AAFES(Europe) X: Australia

⚠ indicates safety critical components.

# TR-851A/E

## PARTS LIST

\* New Parts  
 Parts without Parts No. are not supplied.  
 Les articles non mentionnés dans le Parts No. ne sont pas fournis.  
 Teile ohne Parts No. werden nicht geliefert.

Ref. No. 参照番号	Address 位置	New Parts 新	Parts No. 部品番号	Description 部品名/規格	Desti- nation 仕向	Re- marks 備考
C33			CC73FCH1H070D	CHIP C 7.0PF D		
C34			CC73FCH1H330J	CHIP C 33PF J		
C35	-38		CK73FB1H102K	CHIP C 1000PF K		
TC1	.2	*	C05-0303-05	TRIMMING CAP (20PF)		
TC3		*	C05-0097-05	TRIMMING CAP (30PF)		
J1			E40-0274-05	PIN CONNECTOR (2P)		
J3			E40-3238-05	PIN ASSY (3P)		
J6			E40-3241-05	PIN ASSY (6P)		
J7			E40-3237-05	PIN ASSY (2P)		
200	4E	*	G02-0573-04	GND SPRING (PLATE)		
L1	-4	*	L40-1021-14	SMALL FIXED INDUCTOR(1MH)		
L5		*	L34-4024-05	TUNING COIL (10.7MHZ CAR)		
L7		*	L34-4026-05	TUNING COIL (30MHZ)		
L8		*	L34-4025-05	TUNING COIL (10.7MHZ.MIX)		
L9	-13	*	L34-4027-05	TUNING COIL (42MHZ)		
X1		*	L77-1329-05	CRYSTAL RESONATOR(10.6965MHZ)		
X2		*	L77-1330-05	CRYSTAL RESONATOR(10.6943MHZ)		
R	4E		N35-2604-41	BINDING HEAD MACHINE SCREW		
R1	.2		RK73FB2A101J	CHIP R 100 J 1/10W		
R3			RK73FB2A473J	CHIP R 47K J 1/10W		
R4			R92-0670-05	CHIP R 0 OHM		
R5			RK73FB2A473J	CHIP R 47K J 1/10W		
R6			R92-0670-05	CHIP R 0 OHM		
R7			RK73FB2A562J	CHIP R 5.6K J 1/10W		
R8			RK73FB2A332J	CHIP R 3.3K J 1/10W		
R9			RK73FB2A102J	CHIP R 1.0K J 1/10W		
R10			RK73FB2A682J	CHIP R 6.8K J 1/10W		
R11			RK73FB2A223J	CHIP R 22K J 1/10W		
R12			RK73FB2A102J	CHIP R 1.0K J 1/10W		
R13			RK73FB2A330J	CHIP R 33 J 1/10W		
R14			RK73FB2A224J	CHIP R 220K J 1/10W		
R15	.16		RK73FB2A102J	CHIP R 1.0K J 1/10W		
R17			RK73FB2A103J	CHIP R 10K J 1/10W		
R18			RK73FB2A331J	CHIP R 330 J 1/10W		
R19			RK73FB2A180J	CHIP R 18 J 1/10W		
R20			RK73FB2A331J	CHIP R 330 J 1/10W		
R21			RK73FB2A103J	CHIP R 10K J 1/10W		
R22			RK73FB2A331J	CHIP R 330 J 1/10W		
R23			RK73FB2A180J	CHIP R 18 J 1/10W		
R24			RK73FB2A331J	CHIP R 330 J 1/10W		
R25			RK73FB2A683J	CHIP R 68K J 1/10W		
R26			RK73FB2A103J	CHIP R 10K J 1/10W		
R27			R92-0670-05	CHIP R 0 OHM		
R28			RK73FB2A470J	CHIP R 47 J 1/10W		
R29			R92-0670-05	CHIP R 0 OHM		
R30			RK73FB2A470J	CHIP R 47 J 1/10W		
R31			R92-0679-05	CHIP R 0 OHM		
R32	.33		RK73FB2A470J	CHIP R 47 J 1/10W		
R34	.35		RK73FB2A471J	CHIP R 470 J 1/10W		
R36			RK73FB2A101J	CHIP R 100 J 1/10W		
R37	.38		R92-0670-05	CHIP R 0 OHM		
R39			RK73FB2A103J	CHIP R 10K J 1/10W		
R40	.41		RK73FB2A102J	CHIP R 1.0K J 1/10W		

E: Scandinavia & Europe K: USA P: Canada W: Europe  
 U: PX(Far East, Hawaii) T: England M: Other Areas  
 UE: AAFES(Europe) X: Australia

▲ indicates safety critical components.



## PARTS LIST

\* New Parts  
 Parts without Parts No. are not supplied.  
 Les articles non mentionnés dans le Parts No. ne sont pas fournis.  
 Teile ohne Parts No. werden nicht geliefert.

Ref. No. 参照番号	Address 位置	New Parts 新	Parts No. 部品番号	Description 部品名/規格	Desti- nation 仕向	Re- marks 備考
R42			RK73FB2A101J	CHIP R 100 J 1/10W		
R43			RK73FB2A331J	CHIP R 330 J 1/10W		
R44 -46			R92-0670-05	CHIP R 0 0HM		
R47			RK73FB2A222J	CHIP R 2.2K J 1/10W		
D1 ,2		*	1S526B	CHIP DIODE		
Q1 ,2			2SC2714(Y)	CHIP TRANSISTOR		
Q3 -5		*	3SK151(GR)	CHIP FET		
TH1			112-102-2	THERMISTOR (1K)		
<b>COMPOSITE UNIT (PLL,DRIVE,FRONT) (X50-3050-11)</b>						
C1			CC73FCH1H470J	CHIP C 47PF J		
C2			CC73FSL1H101J	CHIP C 100PF J		
C3			CC73FCH1H470J	CHIP C 47PF J		
C4			CC73FCH1H030C	CHIP C 3.0PF C		
C5			CC73FCH1H100D	CHIP C 10PF D		
C6			CK73FB1E223K	CHIP C 0.022UF K		
C7			CK73FB1H103K	CHIP C 0.010UF K		
C8			CE04EW1A470M	ELECTRO 47UF 10WV		
C9			CC73FSL1H101J	CHIP C 100PF J		
C10			CC73FCH1H220J	CHIP C 22PF J		
C11			CK73FB1E223K	CHIP C 0.022UF K		
C12			CC73FSL1H101J	CHIP C 100PF J		
C13			CC73FCH1HOR5C	CHIP C 0.5PF C		
C14			CC73FCH1H100D	CHIP C 10PF D		
C15 ,16			CK73FB1E223K	CHIP C 0.022UF K		
C17			CK73FB1H103K	CHIP C 0.010UF K		
C18			CC73FCH1H330J	CHIP C 33PF J		
C19			CC73FCH1H100D	CHIP C 10PF D		
C20			CK73FB1H102K	CHIP C 1000PF K		
C21			CC73FCH1HOR5C	CHIP C 0.5PF C		
C22 -24			CK73FB1H102K	CHIP C 1000PF K		
C25			CC73FCH1H030C	CHIP C 3.0PF C		
C26			CK73FB1H102K	CHIP C 1000PF K		
C27			CK73FB1E223K	CHIP C 0.022UF K		
C28			CK73FB1H102K	CHIP C 1000PF K		
C29			CC73FSL1H101J	CHIP C 100PF J		
C30			CC73FCH1H040C	CHIP C 4.0PF C		
C31 ,32			CK73FB1H102K	CHIP C 1000PF K		
C33			CC73FSL1H101J	CHIP C 100PF J		
C34			CK73FB1H102K	CHIP C 1000PF K		
C35			CC73FCH1H120J	CHIP C 12PF J		
C36 ,37			CC73FCH1H270J	CHIP C 27PF J		
C38			CC73FCH1H120J	CHIP C 12PF J		
C39			CG92M1H473K	MYLAR 0.047UF K		
C40			CG92M1H822K	MYLAR 8200PF K		
C41			CK73FB1H103K	CHIP C 0.010UF K		
C42			CE04EW1A470M	ELECTRO 47UF 10WV		
C43			CK73FB1H102K	CHIP C 1000PF K		
C44 ,45			CC73FCH1H100J	CHIP C 18PF J		
C46 ,47			CC73FCH1H330J	CHIP C 33PF J		
C48			CK73FB1H103K	CHIP C 0.010UF K		
C49			CC73FCH1H030C	CHIP C 3.0PF C		
C50			CK73FB1H103K	CHIP C 0.010UF K		
C51 ,52			CC73FCH1H120J	CHIP C 12PF J		
C53 ,54			CC73FCH1H470J	CHIP C 47PF J		

E: Scandinavia & Europe K: USA P: Canada W: Europe  
 U: PX(Far East, Hawaii) T: England M: Other Areas  
 UE: AAFES(Europe) X: Australia

▲ indicates safety critical components.

# TR-851A/E

## PARTS LIST

※ New Parts

Parts without Parts No. are not supplied.

Les articles non mentionnés dans le Parts No. ne sont pas fournis.

Telle ohne Parts No. werden nicht geliefert.

Ref. No.	Address	New Parts	Parts No.	Description	Desti- nation	Re- marks
参照番号	位置	新	部品番号	部品名 / 規格	仕向	備考
C55	.56		CK73FB1H103K	CHIP C	0.010UF	K
C57			CE04EW1A470M	ELECTRØ	47UF	10WV
C58	.59		CK73FB1H102K	CHIP C	1000PF	K
C60			CE04EW1A470M	ELECTRØ	47UF	10WV
C61			CK73FB1H103K	CHIP C	0.010UF	K
C62			CK73FB1H102K	CHIP C	1000PF	K
C63			CC73FCH1H150J	CHIP C	15PF	J
C64	-67		CC73FSL1H101J	CHIP C	100PF	J
C68			C90-2041-05	ELECTRØ	10UF	10WV
C69	-72		CK73FB1H102K	CHIP C	1000PF	K
C73			CK73FB1E223K	CHIP C	0.022UF	K
C74	-76		CC73FCH1H220J	CHIP C	22PF	J
C77			CK73FB1E223K	CHIP C	0.022UF	K
C78			CC73FSL1H101J	CHIP C	100PF	J
C79			CK73FB1H471K	CHIP C	470PF	K
C80			CK73FB1H102K	CHIP C	1000PF	K
C81			CK73FB1H471K	CHIP C	470PF	K
C82			CK73FB1E223K	CHIP C	0.022UF	K
C83			CC73FCH1H040C	CHIP C	4.0PF	C
C84			CC73FCH1H100D	CHIP C	10PF	D
C85			CK73FB1H102K	CHIP C	1000PF	K
C86			CK73FB1H103K	CHIP C	0.010UF	K
C87			CC73FCH1H100D	CHIP C	10PF	D
C88			CC73FCH1H470J	CHIP C	47PF	J
C89			CK73FB1E223K	CHIP C	0.022UF	K
C90			CK73FB1H103K	CHIP C	0.010UF	K
C91			CC73FCH1H330J	CHIP C	33PF	J
C92			CC73FCH1H030C	CHIP C	3.0PF	C
C93			CC73FCH1H0R5C	CHIP C	0.5PF	C
C94			CK73FB1H102K	CHIP C	1000PF	K
C95			CK73FB1H103K	CHIP C	0.010UF	K
C96	-99		CK73FB1E223K	CHIP C	0.022UF	K
C100			CK73FB1H103K	CHIP C	0.010UF	K
C101			CC73FCH1H0R5C	CHIP C	0.5PF	C
C102			CC73FCH1H050C	CHIP C	5.0PF	C
C103			CC73FCH1H010C	CHIP C	1.0PF	C
C104,105			CK73FB1H102K	CHIP C	1000PF	K
C106,107			CC73FCH1H150J	CHIP C	15PF	J
C108			CC73FCH1H330J	CHIP C	33PF	J
C109			CK73FB1E223K	CHIP C	0.022UF	K
C110-112			CK73FB1H102K	CHIP C	1000PF	K
C114			CK73FB1H102K	CHIP C	1000PF	K
C115			CK73FB1H103K	CHIP C	0.010UF	K
C116			CE04EW1A470M	ELECTRØ	47UF	10WV
C117			CK73FB1H102K	CHIP C	1000PF	K
C118			CE04EW1E101M	ELECTRØ	100UF	25WV
C119,120			CK73FB1H103K	CHIP C	0.010UF	K
C121			CE04CW1C470M	ELECTRØ	47UF	16WV
C122			CE04EW1HR47M	ELECTRØ	0.47UF	50WV
C123			CK73FB1E223K	CHIP C	0.022UF	K
C124			CQ92M1H222K	MYLAR	2200PF	K
C125,126			CS15E1E010M	TANTAL	1.0UF	25WV
C127			CK73FB1H103K	CHIP C	0.010UF	K
C128			CE04EW1A470M	ELECTRØ	47UF	10WV
C129,130			CK73FB1H102K	CHIP C	1000PF	K

E: Scandinavia & Europe K: USA P: Canada W: Europe

U: PX(Far East, Hawaii) T: England M: Other Areas

UE: AAFES(Europe) X: Australia

△ indicates safety critical components.

## PARTS LIST

\* New Parts

Parts without Parts No. are not supplied.

Les articles non mentionnés dans le Parts No. ne sont pas fournis.

Telle ohne Parts No. werden nicht geliefert.

Ref. No. 参照番号	Address 位置	New Parts 新	Parts No. 部品番号	Description 部品名 / 規格	Desti- nation 仕 向	Re- marks 備考
C131			CE04EW1A470M	ELECTR0		
C132			CK73FB1H103K	CHIP C	47UF	10WV
C133			CK73FB1H102K	CHIP C	0.010UF	K
C134,135			CC73FCH1H010C	CHIP C	1000PF	K
C136			CK73FB1H102K	CHIP C	1.0PF	C
					1000PF	K
C137			CC73FSL1H101J	CHIP C	100PF	J
C138			CK73FB1H103K	CHIP C	0.010UF	K
C139			CK73FB1H102K	CHIP C	1000PF	K
C140			CC73FCH1H330J	CHIP C	33PF	J
C141,142			CC73FCH1H680J	CHIP C	68PF	J
C143			CC73FCH1H330J	CHIP C	33PF	J
C144			CC73FCH1H010C	CHIP C	1.0PF	C
C145-147			CK73FB1H102K	CHIP C	1000PF	K
C148			CC73FSL1H101J	CHIP C	100PF	J
C149			CK73FB1H102K	CHIP C	1000PF	K
C150			CC73FSL1H101J	CHIP C	100PF	J
C151,152			CK73FB1H102K	CHIP C	1000PF	K
C153			CC73FSL1H101J	CHIP C	100PF	J
C154			CK73FB1H102K	CHIP C	1000PF	K
C155			CC73FSL1H101J	CHIP C	100PF	J
C156,157			CK73FB1H102K	CHIP C	1000PF	K
C158			CC73FSL1H101J	CHIP C	100PF	J
C159			CK73FB1H102K	CHIP C	1000PF	K
C160			CC73FSL1H101J	CHIP C	100PF	J
C161,162			CK73FB1H102K	CHIP C	1000PF	K
C163,164			CC73FSL1H101J	CHIP C	100PF	J
C201,202			CK73FB1H102K	CHIP C	1000PF	K
C203			CK73FB1H471K	CHIP C	470PF	K
C204			CC73FCH1H10DD	CHIP C	10PF	D
C205			CC73FSL1H101J	CHIP C	100PF	J
C206			CK73FB1H102K	CHIP C	1000PF	K
C207			CC73FSL1H101J	CHIP C	100PF	J
C208-210			CK73FB1H102K	CHIP C	1000PF	K
C211			CC73FSL1H101J	CHIP C	100PF	J
C212			CK73FB1H102K	CHIP C	1000PF	K
C213			CC73FSL1H101J	CHIP C	100PF	J
C214,215			CK73FB1H102K	CHIP C	1000PF	K
C216			CK73FB1H471K	CHIP C	470PF	K
C217			CK73FB1H102K	CHIP C	1000PF	K
C218			CC73FSL1H101J	CHIP C	100PF	J
C219			CC73FSL1H101J	CHIP C	100PF	J
C220			CK73FB1H471K	CHIP C	470PF	K
C221			CC73FSL1H101J	CHIP C	100PF	J
C222			CK73FB1H102K	CHIP C	1000PF	K
C223			CC73FSL1H101J	CHIP C	100PF	J
C224			CK73FB1H102K	CHIP C	1000PF	K
C225			CC73FSL1H101J	CHIP C	100PF	J
C226			CK73FB1H102K	CHIP C	1000PF	K
C227			C90-0478-05	ELECTR0	10UF	16WV
C228			CK73FB1H471K	CHIP C	470PF	K
C229,230			CK73FB1H102K	CHIP C	1000PF	K
C231,232			CK73FB1H471K	CHIP C	470PF	K
C233-237			CK73FB1H102K	CHIP C	1000PF	K
C238			CK73FB1H471K	CHIP C	470PF	K
C239			CK73FB1H102K	CHIP C	1000PF	K

E: Scandinavia & Europe K: USA P: Canada W: Europe

U: PX(Far East, Hawaii) T: England M: Other Areas

UE: AAFES(Europe) X: Australia

⚠ indicates safety critical components.

# TR-851A/E

## PARTS LIST

× New Parts  
 Parts without Parts No. are not supplied.  
 Les articles non mentionnés dans le Parts No. ne sont pas fournis.  
 Teile ohne Parts No. werden nicht geliefert.

Ref. No. 参照番号	Address 位置	New Parts 新	Parts No. 部品番号	Description 部品名 / 規格	Desti- nation 仕向	Re- marks 備考
C240			CK73FB1H471K	CHIP C 470PF K		
C241			CS15E1VR47M	TANTAL 0.47UF 35WV		
C242			CK73FB1H103K	CHIP C 0.010UF K		
C243			CK73FB1H102K	CHIP C 1000PF K		
C244			CE04EW1C471M	ELECTRØ 470UF 16WV		
C245			CK73FB1H102K	CHIP C 1000PF K		
C246			CE04EW1V101M	ELECTRØ 100UF 35WV		
C247			CE04EW1A470M	ELECTRØ 47UF 10WV		
C248			CQ92M1H104K	MYLAR 0.10UF K		
C249			C90-0B24-05	ELECTRØ 1UF 50WV		
C250-251			CK73FB1H102K	CHIP C 1000PF K		
C252			CK73FB1H471K	CHIP C 470PF K		
C253			CE04EW1E101M	ELECTRØ 100UF 25WV		
C254-257			CC73FSL1H101J	CHIP C 100PF J		
C258			CK73FB1E223K	CHIP C 0.022UF K		
C259-260			C90-0478-05	ELECTRØ 10UF 16WV		
C261-264			CK73FB1H103K	CHIP C 0.010UF K		
C265			CK73EB1E104K	CHIP C 0.10UF K		
C266-269			CK73FB1H102K	CHIP C 1000PF K		
C270		*	C90-2055-05	ELECTRØ 3.3UF 16WV		
C271			CK73FB1H103K	CHIP C 0.010UF K		
C272			CK73EB1E104K	CHIP C 0.10UF K		
C273			CC73FCH1H220J	CHIP C 22PF J		
C274			CC73FCH1H050C	CHIP C 5.0PF C		
C275			CC73FCH1H010C	CHIP C 1.0PF C		
C301			CC73FCH1H100D	CHIP C 10PF D		
C302			CC73FCH1H030C	CHIP C 3.0PF C		
C303			CK73FB1E223K	CHIP C 0.022UF K		
C304			CK73FB1H102K	CHIP C 1000PF K		
C305			CC73FSL1H101J	CHIP C 100PF J		
C306			CK73FB1H102K	CHIP C 1000PF K		
C307			CC73FCH1H010C	CHIP C 1.0PF C		
C308-310			CK73FB1H102K	CHIP C 1000PF K		
C311			CC73FCH1H390J	CHIP C 39PF J		
C312			CK73FB1H102K	CHIP C 1000PF K		
C313			CC73FCH1H330J	CHIP C 33PF J		
C314			CK73FB1H471K	CHIP C 470PF K		
C315			CC73FCH1H100D	CHIP C 10PF D		
C316			CC73FCH1H060D	CHIP C 6.0PF D		
C317			CK73FB1H102K	CHIP C 1000PF K		
C318			CC73FSL1H101J	CHIP C 100PF J		
C319			CK73FB1H102K	CHIP C 1000PF K		
C320			CK73FB1H103K	CHIP C 0.010UF K		
C321			CK73FB1H102K	CHIP C 1000PF K		
C322			CC73FCH1H330J	CHIP C 33PF J		
C323			CC73FCH1H020C	CHIP C 2.0PF C		
C324			CC73FCH1H220J	CHIP C 22PF J		
C325-326			CK73FB1H103K	CHIP C 0.010UF K		
C327			CC73FCH1H030C	CHIP C 3.0PF C		
C328			CK73FB1H103K	CHIP C 0.010UF K		
C329			CC73FCH1H680J	CHIP C 68PF J		
C330			CK73FB1H103K	CHIP C 0.010UF K		
C331			CK73FB1H102K	CHIP C 1000PF K		
C332			C92-0004-05	CHIP TAN 1UF 16WV		
TC1			C05-0337-05	TRIMMING CAP (30PF)		

E: Scandinavia & Europe K: USA P: Canada W: Europe

U: PX(Far East, Hawaii) T: England M: Other Areas

UE: AAFES(Europe) X: Australia

△ indicates safety critical components.

## PARTS LIST

\* New Parts  
 Parts without Parts No. are not supplied.  
 Les articles non mentionnés dans le Parts No. ne sont pas fournis.  
 Teile ohne Parts No. werden nicht geliefert.

Ref. No. 参照番号	Address 位置	New Parts 新	Parts No. 部品番号	Description 部品名/規格	Desti- nation 仕向	Re- marks 備考
TC2			C05-0030-15	TRIMMING CAP (20PF)		
TC3			C05-0031-15	TRIMMING CAP (10PF)		
TC201,202			C05-0031-15	TRIMMING CAP (10PF)		
TC301			C05-0329-05	TRIMMING CAP (6PF)		
TC302,303			C05-0062-05	TRIMMING CAP (6PF)		
-			E04-0154-05	COAX. CONNECTOR		
-			E04-0157-05	MINI PIN SOCKET		
-			E23-0465-05	TERMINAL		
-		*	E31-3219-25	CONNECTING WIRE(LT)		
J1			E40-3239-05	PIN CONNECTOR (4P)		
J2			E40-3238-05	PIN CONNECTOR (3P)		
J3			E40-3242-05	PIN CONNECTOR (7P)		
J201			E40-3237-05	PIN CONNECTOR (2P)		
J202			E40-3238-05	PIN CONNECTOR (3P)		
J203			E40-3240-05	PIN CONNECTOR (5P)		
J204,205			E40-3238-05	PIN CONNECTOR (3P)		
J206			E40-3242-05	PIN CONNECTOR (7P)		
J207			E40-3237-05	PIN CONNECTOR (2P)		
J208			E40-3242-05	PIN CONNECTOR (7P)		
J301			E40-3237-05	PIN CONNECTOR (2P)		
J302			E40-3238-05	PIN CONNECTOR (3P)		
J303			E40-0311-05	PIN CONNECTOR (3P)		
TP301			E40-0211-05	PIN CONNECTOR (2P)		
-			G02-0535-04	GND SPRING		
CF1 ,2			L72-0336-05	CERAMIC FILTER		
L1 ,2			L40-4791-14	SMALL FIXED INDUCTOR(4.7UH)		
L3			L40-4711-14	SMALL FIXED INDUCTOR(470UH)		
L4			L30-0281-15	IFT (10.7MHZ)		
L5 ,6			L34-2038-05	COIL (31.0MHZ)		
L7			L34-2045-05	COIL (31MHZ)		
L8			L40-1011-14	SMALL FIXED INDUCTOR(100UH)		
L9 ,10			L34-2249-05	COIL (105MHZ)		
L11		*	L79-0801-05	HELICAL (276MHZ)		
L12			L40-1092-14	SMALL FIXED INDUCTOR(1UH)		
L13			L34-0893-05	COIL (3.4T)		
L14 -16			L34-1058-05	COIL (3.2.5T)		
L17			L40-1011-14	SMALL FIXED INDUCTOR(100UH)		
L18			L32-0675-05	OSCILLATING COIL(VCO)		
L19			L40-3391-14	SMALL FIXED INDUCTOR(3.3UH)		
L20 ,21			L40-3311-14	SMALL FIXED INDUCTOR(330UH)		
L22			L34-2140-05	COIL (9.6MHZ)		
L23 ,24			L34-2249-05	COIL (105MHZ)		
L27 ,28			L34-2249-05	COIL (105MHZ)		
L29			L40-3391-14	SMALL FIXED INDUCTOR(3.3UH)		
L30			L34-2015-05	COIL (10.7MHZ)		
L31			L40-1092-14	SMALL FIXED INDUCTOR(1UH)		
L32			L40-1011-14	SMALL FIXED INDUCTOR(100UH)		
L33			L40-1092-14	SMALL FIXED INDUCTOR(1UH)		
L34			L40-1011-14	SMALL FIXED INDUCTOR(100UH)		
L35			L34-0908-05	COIL (3.9.5T)		
L36 -38			L34-1025-05	COIL (3.5.5T)		
L39 ,40		*	L39-0428-05	TOROIDAL COIL		
L41 -43		*	L79-0802-05	HELICAL (393MHZ)		
L44		*	L34-1164-05	COIL (3.3T)		

E: Scandinavia & Europe K: USA P: Canada W: Europe  
 U: PX(Far East, Hawaii) T: England M: Other Areas  
 UE: AAFES(Europe) X: Australia

⚠ indicates safety critical components.

# TR-851A/E

## PARTS LIST

× New Parts

Parts without Parts No. are not supplied.

Les articles non mentionnés dans le Parts No. ne sont pas fournis.

Teile ohne Parts No. werden nicht geliefert.

Ref. No. 参照番号	Address 位置	New Parts 新	Parts No. 部品番号	Description 部品名 / 規格	Desti- nation 仕向	Re- marks 備考
L202,203 L204-206 L207,208 L209 L210		*	L39-0428-05 L79-0649-05 L34-1052-05 L34-1083-05 L34-1052-05	TORSIONAL COIL HELICAL (435MHZ.TX) COIL (3,1.5T) COIL (3,1T) COIL (3,1.5T)		
L211 L301 L302 L303,304 L305			L40-4791-14 L34-1051-05 L34-1052-05 L79-0690-05 L34-1153-05	SMALL FIXED INDUCTOR(4.7UH) COIL COIL (3,1.5T) HELICAL (435MHZ.RX) COIL (3,7T)		
L306,307 L308,309 L310 L311,312 XF1		*	L34-1083-05 L34-2041-05 L34-2045-05 L30-0281-15 L71-0268-05	COIL (3,1T) COIL (42MHZ) COIL (31MHZ) IFT (10.7MHZ) MCF (41.415MHZ)		
XF2			L71-0230-05	MCF (10.695MHZ)		
-			N35-3006-46	BINDING HEAD MACHINE SCREW		
R1 R2 R3 R4 R5			RK73FB2A334J RK73FB2A101J RK73FB2A102J RK73FB2A152J RK73FB2A221J	CHIP R 330K J 1/10W CHIP R 100 J 1/10W CHIP R 1.0K J 1/10W CHIP R 1.5K J 1/10W CHIP R 220 J 1/10W		
R6 R7 R8 R9 R10			RK73FB2A334J RK73FB2A471J RK73FB2A473J RK73FB2A103J RK73FB2A221J	CHIP R 330K J 1/10W CHIP R 470 J 1/10W CHIP R 47K J 1/10W CHIP R 10K J 1/10W CHIP R 220 J 1/10W		
R11 -13 R14 .15 R16 R17 R18			RK73FB2A101J RK73FB2A102J RK73FB2A221J RK73FB2A332J RK73FB2A102J	CHIP R 100 J 1/10W CHIP R 1.0K J 1/10W CHIP R 220 J 1/10W CHIP R 3.3K J 1/10W CHIP R 1.0K J 1/10W		
R19 R20 R21 R22 R23			RK73FB2A101J RK73FB2A222J RK73FB2A102J RK73FB2A101J RK73EB2B101J	CHIP R 100 J 1/10W CHIP R 2.2K J 1/10W CHIP R 1.0K J 1/10W CHIP R 100 J 1/10W CHIP R 100 J 1/8W		
R24 R25 R26 R27 R28			R92-0670-05 RK73FB2A331J RK73FB2A180J RK73FB2A331J RK73FB2A332J	CHIP R 0 OHM CHIP R 330 J 1/10W CHIP R 18 J 1/10W CHIP R 330 J 1/10W CHIP R 3.3K J 1/10W		
R29 R30 R31 R32 .33 R34			RK73FB2A224J RK73FB2A333J RK73FB2A152J RK73FB2A103J RK73FB2A101J	CHIP R 220K J 1/10W CHIP R 33K J 1/10W CHIP R 1.5K J 1/10W CHIP R 10K J 1/10W CHIP R 100 J 1/10W		
R35 R36 R37 R38 R39			RK73FB2A223J RK73FB2A103J RK73FB2A471J RK73FB2A101J RK73FB2A124J	CHIP R 22K J 1/10W CHIP R 10K J 1/10W CHIP R 470 J 1/10W CHIP R 100 J 1/10W CHIP R 120K J 1/10W		
R40			RK73FB2A152J	CHIP R 1.5K J 1/10W		

E: Scandinavia & Europe K: USA P: Canada W: Europe

U: PX(Far East, Hawaii) T: England M: Other Areas

UE: AAFES(Europe) X: Australia

△ indicates safety critical components.

## PARTS LIST

× New Parts

Parts without Parts No. are not supplied.

Les articles non mentionnés dans le Parts No. ne sont pas fournis.

Telle ohne Parts No. werden nicht geliefert.

Ref. No. 参照番号	Address 位置	New Parts 新	Parts No. 部品番号	Description 部品名/規格	Desti- nation 仕向	Re- marks 備考
R41			RK73FB2A103J	CHIP R 10K J 1/10W		
R42			RK73FB2A682J	CHIP R 6.8K J 1/10W		
R43			RK73FB2A101J	CHIP R 100 J 1/10W		
R44			RK73FB2A471J	CHIP R 470 J 1/10W		
R45			RK73FB2A472J	CHIP R 4.7K J 1/10W		
R46			RK73FB2A102J	CHIP R 1.0K J 1/10W		
R47			RK73FB2A101J	CHIP R 100 J 1/10W		
R48	.49		RK73FB2A103J	CHIP R 10K J 1/10W		
R50			RK73FB2A474J	CHIP R 470K J 1/10W		
R51			RK73FB2A471J	CHIP R 470 J 1/10W		
R52	.53		RK73FB2A102J	CHIP R 1.0K J 1/10W		
R54			RK73FB2A474J	CHIP R 470K J 1/10W		
R55			RK73FB2A471J	CHIP R 470 J 1/10W		
R56			RK73FB2A474J	CHIP R 470K J 1/10W		
R57			RK73FB2A101J	CHIP R 100 J 1/10W		
R58			RK73FB2A221J	CHIP R 220 J 1/10W		
R59			R92-0679-05	CHIP R 0 0HM		
R60			RK73FB2A474J	CHIP R 470K J 1/10W		
R61			RK73FB2A102J	CHIP R 1.0K J 1/10W		
R62			RK73FB2A101J	CHIP R 100 J 1/10W		
R63			RK73FB2A680J	CHIP R 68 J 1/10W		
R64			RK73FB2A334J	CHIP R 330K J 1/10W		
R65			RK73FB2A472J	CHIP R 4.7K J 1/10W		
R66			RK73FB2A224J	CHIP R 220K J 1/10W		
R67			RK73FB2A152J	CHIP R 1.5K J 1/10W		
R68			RK73FB2A103J	CHIP R 10K J 1/10W		
R69	.70		RK73FB2A333J	CHIP R 33K J 1/10W		
R71			RK73FB2A101J	CHIP R 100 J 1/10W		
R72			RK73FB2A152J	CHIP R 1.5K J 1/10W		
R73			RK73FB2A101J	CHIP R 100 J 1/10W		
R75			RK73FB2A101J	CHIP R 100 J 1/10W		
R76			RK73FB2A152J	CHIP R 1.5K J 1/10W		
R77			RK73FB2A103J	CHIP R 10K J 1/10W		
R78			RK73FB2A124J	CHIP R 120K J 1/10W		
R79			RK73FB2A104J	CHIP R 100K J 1/10W		
R80			R92-0670-05	CHIP R 0 0HM		
R81			RK73FB2A472J	CHIP R 4.7K J 1/10W		
R82			R92-0679-05	CHIP R 0 0HM		
R83	.84		RK73FB2A272J	CHIP R 2.7K J 1/10W		
R85			RK73FB2A222J	CHIP R 2.2K J 1/10W		
R86			RK73FB2A224J	CHIP R 220K J 1/10W		
R87			RK73FB2A222J	CHIP R 2.2K J 1/10W		
R88			R92-0670-05	CHIP R 0 0HM		
R89			RK73FB2A101J	CHIP R 100 J 1/10W		
R90			RK73FB2A472J	CHIP R 4.7K J 1/10W		
R91			RK73FB2A470J	CHIP R 47 J 1/10W		
R92			RK73FB2A101J	CHIP R 100 J 1/10W		
R93			RK73FB2A470J	CHIP R 47 J 1/10W		
R94			RK73FB2A472J	CHIP R 4.7K J 1/10W		
R95			RK73FB2A102J	CHIP R 1.0K J 1/10W		
R96			RK73FB2A470J	CHIP R 47 J 1/10W		
R97			RK73FB2A102J	CHIP R 1.0K J 1/10W		
R98			RK73FB2A151J	CHIP R 150 J 1/10W		
R99			RK73FB2A470J	CHIP R 47 J 1/10W		
R100			RK73FB2A151J	CHIP R 150 J 1/10W		

E: Scandinavia & Europe K: USA P: Canada W: Europe

U: PX(Far East, Hawaii) T: England M: Other Areas

UE: AAFES(Europe) X: Australia

⚠ indicates safety critical components.

## PARTS LIST

\* New Parts

Parts without Parts No. are not supplied.

Les articles non mentionnés dans le Parts No. ne sont pas fournis.

Teile ohne Parts No. werden nicht geliefert.

Ref. No. 参照番号	Address 位置	New Parts 新	Parts No. 部品番号	Description 部品名 / 規格	Desti- nation 仕向	Re- marks 備考
R101			RK73FB2A331J	CHIP R 330 J 1/10W		
R102			RK73FB2A180J	CHIP R 18 J 1/10W		
R103			RK73FB2A331J	CHIP R 330 J 1/10W		
R104			R92-0679-05	CHIP R 0 0HM		
R105			RK73FB2A472J	CHIP R 4.7K J 1/10W		
R106			RK73FB2A102J	CHIP R 1.0K J 1/10W		
R107, 108			RK73FB2A101J	CHIP R 100 J 1/10W		
R109			RK73FB2A332J	CHIP R 3.3K J 1/10W		
R110			RK73FB2A102J	CHIP R 1.0K J 1/10W		
R111, 112			RK73FB2A101J	CHIP R 100 J 1/10W		
R113			R92-0679-05	CHIP R 0 0HM		
R114			RK73FB2A151J	CHIP R 150 J 1/10W		
R115			RK73FB2A470J	CHIP R 47 J 1/10W		
R116			RK73FB2A151J	CHIP R 150 J 1/10W		
R117			RK73FB2A102J	CHIP R 1.0K J 1/10W		
R118			RK73FB2A471J	CHIP R 470 J 1/10W		
R119			RK73FB2A101J	CHIP R 100 J 1/10W		
R120			RK73EB2B101J	CHIP R 100 J 1/8W		
R121			RK73FB2A331J	CHIP R 330 J 1/10W		
R122			RK73FB2A180J	CHIP R 18 J 1/10W		
R123			RK73FB2A331J	CHIP R 330 J 1/10W		
R124			RK73FB2A332J	CHIP R 3.3K J 1/10W		
R125, 126			RK73FB2A101J	CHIP R 100 J 1/10W		
R127			RK73FB2A472J	CHIP R 4.7K J 1/10W		
R128, 129			R92-0679-05	CHIP R 0 0HM		
R130			R92-0670-05	CHIP R 0 0HM		
R174			RK73FB2A102J	CHIP R 1.0K J 1/10W		
R201			RK73FB2A331J	CHIP R 330 J 1/10W		
R202			RK73FB2A180J	CHIP R 18 J 1/10W		
R203, 204			RK73FB2A331J	CHIP R 330 J 1/10W		
R205			RK73FB2A180J	CHIP R 18 J 1/10W		
R206			RK73FB2A331J	CHIP R 330 J 1/10W		
R207			RK73FB2A102J	CHIP R 1.0K J 1/10W		
R208			RK73FB2A470J	CHIP R 47 J 1/10W		
R209			RK73FB2A471J	CHIP R 470 J 1/10W		
R210			RK73FB2A332J	CHIP R 3.3K J 1/10W		
R211			RK73FB2A470J	CHIP R 47 J 1/10W		
R212, 213			RK73FB2A220J	CHIP R 22 J 1/10W		
R214			RK73FB2A471J	CHIP R 470 J 1/10W		
R215			RK73FB2A332J	CHIP R 3.3K J 1/10W		
R216			RK73FB2A330J	CHIP R 33 J 1/10W		
R217			RK73FB2A220J	CHIP R 22 J 1/10W		
R218			RK73FB2A330J	CHIP R 33 J 1/10W		
R220			RK73FB2A152J	CHIP R 1.5K J 1/10W		
R221			RK73FB2A470J	CHIP R 47 J 1/10W		
R222			RK73FB2A330J	CHIP R 33 J 1/10W		
R223-225			RK73FB2A220J	CHIP R 22 J 1/10W		
R226			RK73FB2A470J	CHIP R 47 J 1/10W		
R227			RK73FB2A152J	CHIP R 1.5K J 1/10W		
R228			RK73FB2A331J	CHIP R 330 J 1/10W		
R229			R92-0670-05	CHIP R 0 0HM		
R230			RK73FB2A103J	CHIP R 10K J 1/10W		
R231			RK73FB2A102J	CHIP R 1.0K J 1/10W		
R231			RK73FB2A222J	CHIP R 2.2K J 1/10W		
R232, 233			RK73FB2A474J	CHIP R 470K J 1/10W		

E: Scandinavia & Europe K: USA P: Canada W: Europe

U: PX(Far East, Hawaii) T: England M: Other Areas

UE: AAFES(Europe) X: Australia

▲ indicates safety critical components.



## PARTS LIST

× New Parts  
 Parts without Parts No. are not supplied.  
 Les articles non mentionnés dans le Parts No. ne sont pas fournis.  
 Teile ohne Parts No. werden nicht geliefert.

Ref. No. 参照番号	Address 位置	New Parts 新	Parts No. 部品番号	Description 部品名 / 規格	Desti- nation 仕 向	Re- marks 備考
R234			RK73FB2A103J	CHIP R 10K J 1/10W		
R235			R92-0670-05	CHIP R 0 0HM		
R236			RK73FB2A103J	CHIP R 10K J 1/10W		
R237			RK73FB2A822J	CHIP R 8.2K J 1/10W		
R238			RK73FB2A223J	CHIP R 22K J 1/10W		
R239			RK73FB2A822J	CHIP R 8.2K J 1/10W		
R240			RK73FB2A471J	CHIP R 470 J 1/10W		
R241			RK73FB2A124J	CHIP R 120K J 1/10W		
R242			RK73FB2A473J	CHIP R 47K J 1/10W		
R243			RK73FB2A124J	CHIP R 120K J 1/10W		
R244			RK73FB2A153J	CHIP R 15K J 1/10W		
R245			RK73FB2A272J	CHIP R 2.7K J 1/10W		
R246			RK73FB2A104J	CHIP R 100K J 1/10W		
R247			RK73FB2A103J	CHIP R 10K J 1/10W		
R248			RK73FB2A153J	CHIP R 15K J 1/10W		
R249			RK73FB2A333J	CHIP R 33K J 1/10W		
R250			RK73FB2A153J	CHIP R 15K J 1/10W		
R251			RK73FB2A333J	CHIP R 33K J 1/10W		
R252			RK73FB2A102J	CHIP R 1.0K J 1/10W		
R253			RK73FB2A333J	CHIP R 33K J 1/10W		
R254			RK73FB2A124J	CHIP R 120K J 1/10W		
R255			RK73FB2A223J	CHIP R 22K J 1/10W		
R256			RK73FB2A473J	CHIP R 47K J 1/10W		
R257			RK73FB2A104J	CHIP R 100K J 1/10W		
R258			RK73FB2A124J	CHIP R 120K J 1/10W		
R260			RD14BB2C152J	RD 1.5K J 1/6W		
R261			R92-0670-05	CHIP R 0 0HM		
R301			RK73FB2A223J	CHIP R 22K J 1/10W		
R302			RK73FB2A104J	CHIP R 100K J 1/10W		
R303			RK73FB2A101J	CHIP R 100 J 1/10W		
R304, 305			RK73FB2A470J	CHIP R 47 J 1/10W		
R306			R92-0670-05	CHIP R 0 0HM		
R307			RK73FB2A102J	CHIP R 1.0K J 1/10W		
R308			RK73FB2A220J	CHIP R 22 J 1/10W		
R309			RK73FB2A680J	CHIP R 68 J 1/10W		
R310			RK73FB2A472J	CHIP R 4.7K J 1/10W		
R311			RK73FB2A223J	CHIP R 22K J 1/10W		
R312			RK73FB2A472J	CHIP R 4.7K J 1/10W		
R313			RK73FB2A473J	CHIP R 47K J 1/10W		
R314			RK73FB2A331J	CHIP R 330 J 1/10W		
R315			RK73FB2A101J	CHIP R 100 J 1/10W		
R316			R92-0670-05	CHIP R 0 0HM		
R317			RK73FB2A104J	CHIP R 100K J 1/10W		
R318			RK73FB2A473J	CHIP R 47K J 1/10W		
R319			RK73FB2A334J	CHIP R 330K J 1/10W		
R320			RK73FB2A470J	CHIP R 47 J 1/10W		
R321			RK73FB2A331J	CHIP R 330 J 1/10W		
R322			RK73FB2A103J	CHIP R 10K J 1/10W		
R323			RK73FB2A101J	CHIP R 100 J 1/10W		
R324			R92-0670-05	CHIP R 0 0HM		
R325			RK73FB2A102J	CHIP R 1.0K J 1/10W		
R326			RK73FB2A472J	CHIP R 4.7K J 1/10W		
R327			RK73FB2A103J	CHIP R 10K J 1/10W		
R328			RK73FB2A102J	CHIP R 1.0K J 1/10W		
R329			R92-0670-05	CHIP R 0 0HM		

E: Scandinavia & Europe K: USA P: Canada W: Europe

U: PX(Far East, Hawaii) T: England M: Other Areas

UE: AAFES(Europe) X: Australia

⚠ indicates safety critical components.

# TR-851A/E

## PARTS LIST

× New Parts

Parts without Parts No. are not supplied.

Les articles non mentionnés dans le Parts No. ne sont pas fournis.

Teile ohne Parts No. werden nicht geliefert.

Ref. No. 参照番号	Address 位置	New Parts 新	Parts No. 部品番号	Description 部品名 / 規格	Desti- nation 仕 向	Re- marks 備考
R330			RK73FB2A102J	CHIP R 1.0K J 1/10W		
R331			RK73FB2A101J	CHIP R 100 J 1/10W		
R332			RK73FB2A473J	CHIP R 47K J 1/10W		
VR1			R12-1069-05	TRIMMING P8T. (4.7K)		
VR3			R12-3097-05	TRIMMING P8T. (22K)		
VR4			R12-1430-05	TRIMMING P8T. (3K)		
VR5 ,6			R12-3099-05	TRIMMING P8T. (47K)		
VR7			R12-6012-05	TRIMMING P8T. (470K)		
D1			1SV153	VARI-CAP DIODE		
D2			ND487C1-3R	DIODE		
D3			1SS184	CHIP DIODE		
D4 ,5			1SS277	DIODE		
D201			ND487C1-3R	DIODE		
D202			1SS226	CHIP DIODE		
D203,204			1SS184	CHIP DIODE		
D205			1N60PSPA	DIODE		
D206-208			1SS184	CHIP DIODE		
D301			1SS268	CHIP DIODE		
IC1			TC9172P	IC(PRE SCALER PLL)		
IC2			TC74HC390P	IC		
IC3			TC5082P-G	IC		
IC4			SN16913P	IC(DUBLE BALANCED MIXERS)		
IC5			TC9172P	IC(PRE SCALER PLL)		
IC6			L78N08	IC		
IC7			NJM78L05A	IC(VOLTAGE REGULATOR/ +5V)		
IC201			MB3712	IC(AF POWER AMP)		
Q1 -3			2SC2715(Y)	CHIP TRANSISTOR		
Q4			2SC2714(Y)	CHIP TRANSISTOR		
Q5			2SC3098	CHIP TRANSISTOR		
Q6			2SC3356	CHIP TRANSISTOR		
Q7 -9			2SC3324(G,B)	CHIP TRANSISTOR		
Q10 ,11			2SC2714(Y)	CHIP TRANSISTOR		
Q12 ,13			2SC2712(Y)	CHIP TRANSISTOR		
Q14 -18			2SC2714(Y)	CHIP TRANSISTOR		
Q19			3SK151(GR)	CHIP FET		
Q20 ,21			DTC124EK	DIGITAL TRANSISTOR		
Q22			DTA143EK	DIGITAL TRANSISTOR		
Q23			DTC124EK	DIGITAL TRANSISTOR		
Q24			DTA143EK	DIGITAL TRANSISTOR		
Q25 -27			2SC3324(G,B)	CHIP TRANSISTOR		
Q28			2SC2714(Y)	CHIP TRANSISTOR		
Q29 ,30			2SC3098	CHIP TRANSISTOR		
Q31			2SC3356	CHIP TRANSISTOR		
Q201,202			2SC3098	CHIP TRANSISTOR		
Q203			2SC3356	CHIP TRANSISTOR		
Q204			2SC2762	TRANSISTOR		
Q205			2SC2712(Y)	CHIP TRANSISTOR		
Q206			DTC124EK	DIGITAL TRANSISTOR		
Q207			2SC2712(Y)	CHIP TRANSISTOR		
Q208			DTA143EK	DIGITAL TRANSISTOR		
Q209			2SA1162(Y)	CHIP TRANSISTOR		
Q210			DTA143EK	DIGITAL TRANSISTOR		
Q301			3SK184(S)	CHIP FET		
Q302			2SK125	FET		

E: Scandinavia & Europe K: USA P: Canada W: Europe

U: PX(Far East, Hawaii) T: England M: Other Areas

UE: AAFES(Europe) X: Australia

△ indicates safety critical components.

## PARTS LIST

× New Parts

Parts without Parts No. are not supplied.

Les articles non mentionnés dans le Parts No. ne sont pas fournis.

Telle ohne Parts No. werden nicht geliefert.

Ref. No. 参照番号	Address 位置	New Parts 新	Parts No. 部品番号	Description 部品名 / 規格	Desti- nation 仕 向	Re- marks 備考
Q303			3SK184(S)	CHIP FET		
Q304		*	3SK179(L)	CHIP FET		
Q305			DTA114EK	DIGITAL TRANSISTOR		
Q306			DTC114EK	DIGITAL TRANSISTOR		
-		*	X58-1000-01	VCO UNIT		
-		*	X58-3060-00	10.240SC UNIT		
-		*	X58-3070-00	RIT UNIT		
-			X59-1130-00	CW BREAK IN UNIT		
<b>CONTROL UNIT (X53-1460-XX) -12 : K,M -52 : T -62 : W</b>						
-			A33-0404-02	REFLECTOR		
-		*	B11-0438-03	LIGHT GLUIDING PLATE		
-			B31-0658-15	METER		
D213		*	B30-0846-05	LED (AMBER)	K1M1	
D301		*	B30-0844-05	LED (ORANGE)		
D302		*	B30-0842-05	LED (RED)		
D303-305		*	B30-0843-05	LED (GREEN)		
D306		*	B30-0844-05	LED (ORANGE)		
D307		*	B30-0843-05	LED (GREEN)		
D308		*	B30-0842-05	LED (RED)		
PL1			B30-0845-05	LAMP FOR METER		
PL301,302			B30-0828-05	LAMP (12V60MA)GREEN CAP		
C1			CK73FB1H103K	CHIP C 0.010UF K		
C2			CK73FB1H102K	CHIP C 1000PF K		
C4 -7			CK73FB1H102K	CHIP C 1000PF K		
C8			CK73FB1H103K	CHIP C 0.010UF K		
C9 -11			CK73FB1H102K	CHIP C 1000PF K		
C12			CK73FB1E223K	CHIP C 0.022UF K		
C13 ,14			CK73FB1H103K	CHIP C 0.010UF K		
C15			C90-2041-05	ELECTRØ 10UF 10WV		
C16			CK73FB1H103K	CHIP C 0.010UF K		
C17			CE04EW1A470M	ELECTRØ 47UF 10WV		
C18			C90-0822-05	ELECTRØ 47UF 16WV		
C19			CK73FB1H103K	CHIP C 0.010UF K		
C20 ,21			CK73FB1H102K	CHIP C 1000PF K		
C22			C90-0824-05	ELECTRØ 1UF 50WV		
C28			CE04CW1H2R2M	ELECTRØ 2.2UF 50WV		
C29			CK73FB1H102K	CHIP C 1000PF K	T1W1	
C30			CK73FB1H472K	CHIP C 4700PF K	T1W1	
C31			CK73FB1H103K	CHIP C 0.010UF K	T1W1	
C32			CK73EB1H333K	CHIP C 0.033UF K	T1W1	
C33			C90-0480-05	ELECTRØ 47UF 10WV	T1W1	
C34			CK73FB1H103K	CHIP C 0.010UF K	T1W1	
C35			C91-0433-05	CERAMIC 0.0039	T1W1	
C36 ,37			CK73FB1H102K	CHIP C 1000PF K		
C38			CK73FB1H103K	CHIP C 0.010UF K		
C39 -44			CC73FCH1H101J	CHIP C 100PF J		
C45			C90-0824-05	ELECTRØ 1UF 50WV	K1M1	
C46			CK73FB1E223K	CHIP C 0.022UF K		
C49			CE04CW1H100M	ELECTRØ 10UF 50WV	T1	
C201			CK73FB1H102K	CHIP C 1800PF K		
C202			CK73FB1H102K	CHIP C 1000PF K		
C204			CK73FB1H332K	CHIP C 3300PF K		
C205			CK73FB1H471K	CHIP C 470PF K		

E: Scandinavia & Europe K: USA P: Canada W: Europe

U: PX(Far East, Hawaii) T: England M: Other Areas

UE: AAFES(Europe) X: Australia

⚠ indicates safety critical components.

# TR-851A/E

## PARTS LIST

× New Parts  
 Parts without Parts No. are not supplied.  
 Les articles non mentionnés dans le Parts No. ne sont pas fournis.  
 Teile ohne Parts No. werden nicht geliefert.

Ref. No. 参照番号	Address 位置	New Parts 新	Parts No. 部品番号	Description 部品名 / 規格	Desti- nation 仕向	Re- marks 備考
C206 C207,208 C209 C210 C211			CE04CW1C100M CK73FB1E223K CK73FB1H102K CK73FB1H103K CC73FCH1H101J	ELECTRØ 10UF 16WV CHIP C 0.022UF K CHIP C 1000PF K CHIP C 0.010UF K CHIP C 100PF J		
C212-215 C216-219 C220 C221 C222			CK73FB1H102K CK73FB1E223K CK73FB1H102K CK73EB1H473K CK73FB1H102K	CHIP C 1000PF K CHIP C 0.022UF K CHIP C 1000PF K CHIP C 0.047UF K CHIP C 1000PF K		
C223 C301-304 C305			C90-2031-05 CK73FB1H103K CC73FCH1H330J	ELECTRØ 4.7UF 10WV CHIP C 0.010UF K CHIP C 33PF J		
- - - - J1			E06-0858-05 E23-0512-05 E29-0428-04 E29-0469-08 E40-5069-05	ØP METAL SOCKET TERMINAL TERMINAL (SW UNIT) INTER CONNECTOR PIN CONNECTOR (12P)		
J2 J3 J4 J5 J6			E40-5068-05 E40-3242-05 E40-3240-05 E40-5067-05 E40-3243-05	PIN CONNECTOR (11P) PIN CONNECTOR (7P) PIN CONNECTOR (5P) PIN CONNECTOR (10P) PIN CONNECTOR (8P)		
J7 J8 ,9 J10 J201 J202			E40-5021-05 E40-5022-05 E40-5019-05 E40-3237-05 E40-3241-05	PIN CONNECTOR (7P) PIN CONNECTOR (8P) PIN CONNECTOR (5P) PIN CONNECTOR (2P) PIN CONNECTOR (6P)		K1M1
J203 J204 J205 TP9			E40-5067-05 E40-3243-05 E40-3238-05 E40-0211-05	PIN CONNECTOR (10P) PIN CONNECTOR (8P) PIN CONNECTOR (3P) PIN CONNECTOR (2P)		T1W1
-		*	J19-1421-04	COVER		
X1		*	L78-0017-05	RESONATOR (4.194MHZ)		
- -		*	N09-0608-05 N09-0698-05	SCREW SCREW (Ø1.7X5)		
JR1 JR2 JR4 JR5 JR201			R92-0670-05 R92-0670-05 R92-0670-05 R92-0670-05 R92-0670-05	CHIP R 0 ØHM CHIP R 0 ØHM CHIP R 0 ØHM CHIP R 0 ØHM CHIP R 0 ØHM		K1M1 T1W1 W1
JR301,302 R1 R2 ,3 R4 -6 R7		*	R92-0670-05 R90-0462-05 RK73FB2A103J RD14CB2C151J RD14CB2C331J	CHIP R 0 ØHM MULTI-COMP (47KXØ) CHIP R 10K J 1/10W RD 150 J 1/6W RD 330 J 1/6W		
R8 R9 R10 R11 -15 R16 ,17 R18			RD14BB2C151J RK73FB2A473J RK73FB2A472J RK73FB2A473J RK73FB2A273J RK73FB2A103J	RD 150 J 1/6W CHIP R 47K J 1/10W CHIP R 4.7K J 1/10W CHIP R 47K J 1/10W CHIP R 27K J 1/10W CHIP R 10K J 1/10W		

E: Scandinavia & Europe K: USA P: Canada W: Europe

U: PX(Far East, Hawaii) T: England M: Other Areas

UE: AAFES(Europe) X: Australia

△ indicates safety critical components.

## PARTS LIST

\* New Parts  
 Parts without Parts No. are not supplied.  
 Les articles non mentionnés dans le Parts No. ne sont pas fournis.  
 Teile ohne Parts No. werden nicht geliefert.

Ref. No. 参照番号	Address 位置	New Parts 新	Parts No. 部品番号	Description 部品名/規格	Desti- nation 仕向	Re- marks 備考
R19			RK73FB2A471J	CHIP R 470 J 1/10W		
R20			RD14DB2H470J	SMALL-RD 47 J 1/2W		
R21			RK73FB2A473J	CHIP R 47K J 1/10W		
R24			RK73FB2A183J	CHIP R 18K J 1/10W	K1M1	
R32			RK73FB2A273J	CHIP R 27K J 1/10W	T1W1	
R33			RK73FB2A393J	CHIP R 39K J 1/10W	T1W1	
R34			RK73FB2A123J	CHIP R 12K J 1/10W	T1W1	
R35			RK73FB2A472J	CHIP R 4.7K J 1/10W	T1W1	
R36			RN14BK2B7102F	RN 91.0K F 1/8W	T1W1	
R37			RK73FB2A560J	CHIP R 56 J 1/10W		
R38			RK73FB2A273J	CHIP R 27K J 1/10W		
R40			RK73FB2A472J	CHIP R 4.7K J 1/10W		
R41			RK73FB2A332J	CHIP R 3.3K J 1/10W		
R42			RK73FB2A102J	CHIP R 1.0K J 1/10W		
R43			RK73FB2A103J	CHIP R 10K J 1/10W	T1	
R201			RK73FB2A103J	CHIP R 10K J 1/10W		
R203			RK73FB2A823J	CHIP R 82K J 1/10W		
R204			RK73FB2A683J	CHIP R 68K J 1/10W		
R205			RK73FB2A684J	CHIP R 680K J 1/10W		
R206			RK73FB2A564J	CHIP R 560K J 1/10W		
R207			RK73FB2A103J	CHIP R 10K J 1/10W		
R208, 209			RK73FB2A182J	CHIP R 1.8K J 1/10W		
R210, 211			RK73FB2A153J	CHIP R 15K J 1/10W		
R212			RD14BB2E470J	RD 47 J 1/4W		
R213			RD14BB2E100J	RD 10 J 1/4W		
R214		*	R90-0462-05	MULTI-COMP (47KXB)		
R215-217			RK73FB2A102J	CHIP R 1.0K J 1/10W		
R218			RK73FB2A101J	CHIP R 100 J 1/10W		
R219			RD14BB2C101J	RD 100 J 1/6W		
R220			RK73FB2A103J	CHIP R 10K J 1/10W		
R221			RK73EB2B821J	CHIP R 820 J 1/8W		
R222			RK73EB2B122J	CHIP R 1.2K J 1/8W		
R224			RK73EB2B122J	CHIP R 1.2K J 1/8W		
R225			RK73EB2B821J	CHIP R 820 J 1/8W		
R301-303			RK73EB2B152J	CHIP R 1.5K J 1/8W	K1M1	
R304-307			RK73EB2B222J	CHIP R 2.2K J 1/8W		
R308, 309			RK73EB2B123J	CHIP R 12K J 1/8W		
R310			RK73EB2B393J	CHIP R 39K J 1/8W		
VR2		*	R12-3523-05	TRIMMING PBT. (20K)	T1W1	
VR4		*	R23-3403-05	POTENTIOMETER (10KBX2)		
VR5		*	R23-9402-05	POTENTIOMETER (10KK,50KB)		
S201-204			S40-1411-05	TACT SWITCH		
S205			S40-2444-05	PUSH SWITCH (NON LOCK)		
S206, 207			S40-2443-05	PUSH SWITCH (LOCK)		
S208			S40-2444-05	PUSH SWITCH (NON LOCK)		
S209-218			S50-1426-05	TACT SWITCH		
S219-223			S40-1411-05	TACT SWITCH		
S225			S31-1411-05	SLIDE SWITCH		
-		*	FSD-8168B	LCD	K1M1T1	
-		*	FSD-8168G	LCD	W1	
D1			1SS133	DIODE	T1W1	
D2			1SS133	DIODE		
D3			1SS133	DIODE	K1M1	

E: Scandinavia & Europe K: USA P: Canada W: Europe

U: PX(Far East, Hawaii) T: England M: Other Areas

UE: AAFES(Europe) X: Australia

▲ indicates safety critical components.

# TR-851A/E

## PARTS LIST

\* New Parts  
 Parts without Parts No. are not supplied.  
 Les articles non mentionnés dans le Parts No. ne sont pas fournis.  
 Teile ohne Parts No. werden nicht geliefert.

Ref. No. 参照番号	Address 位置	New Parts 新	Parts No. 部品番号	Description 部品名/規格	Desti- nation 仕向	Re- marks 備考
D4 -5			1SS133	DIODE	W1	
D6			1SS133	DIODE	T1	
D7			1SS133	DIODE	T1W1	
D8			1SS133	DIODE		
D9			1SS133	DIODE		
D11			1SS133	DIODE	K1M1	
D14			1SS133	DIODE		
D16 -18			1SS133	DIODE		
D19 ,20			DAN202(K)	CHIP DIODE		
D19 ,20			1SS184	CHIP DIODE		
D21			DAP202(K)	CHIP DIODE		
D21			1SS181	CHIP DIODE		
D22 -24			1SS133	DIODE		
D25 ,26			DAN202(K)	CHIP DIODE		
D25 ,26			1SS184	CHIP DIODE		
D27			DAP202(K)	CHIP DIODE		
D27			1SS181	CHIP DIODE		
D29			1SS106	DIODE	T1W1	
D30			DAN202(K)	CHIP DIODE	T1W1	
D30			1SS184	CHIP DIODE		
D31			DAN202(K)	CHIP DIODE		
D31			1SS184	CHIP DIODE		
D33			DAN202(K)	CHIP DIODE		
D33			1SS184	CHIP DIODE		
D201-206			DAP202(K)	CHIP DIODE		
D201-206			1SS181	CHIP DIODE		
D207-211			1SS133	DIODE		
D212		*	LN322GP	LED (GREEN)		
IC1		*	7508HG-564-22	IC(MICROPROCESSOR)		
IC2		*	DT5C124E	IC		
IC3		*	DT5A143E	IC		
IC4			UPD7507SCT-226	IC(MICROPROCESSOR)		
IC5			NJM293DL-06B	IC	T1W1	
IC6			NE555P	IC		
IC201		*	BU4584B	IC(INVERTER X6)		
IC202		*	PST523C	IC(SYSTEM RESET)		
IC301		*	UPD7514G-143-12	IC(MICROPROCESSOR)		
Q4			DTC114EK	DIGITAL TRANSISTOR		
Q5		*	DTA114TK	DIGITAL TRANSISTOR		
Q6			DTC114EK	DIGITAL TRANSISTOR		
Q7 ,8		*	DTA114EK	DIGITAL TRANSISTOR		
Q201-203			DTC114EK	DIGITAL TRANSISTOR	K1M1	
Q301		*	DTC114EK	DIGITAL TRANSISTOR		
Q302		*	DTC114EK	DIGITAL TRANSISTOR		
-		*	WQ2-0376-05	LCD ASSY	K1M1	
-		*	WQ2-0377-05	LCD ASSY	T1	
-		*	WQ2-0387-05	LCD ASSY	W1	
S224		*	WQ2-0374-05	ROTARY ENCODER (SGF)		
<b>VCO (X58-1000-01)</b>						
C1			CQ92M1H473K	MYLAR 0.047UF K		
C2			CK73FB1H102K	CHIP C 1000PF K		
C3			CC73FCH1H200J	CHIP C 20PF J		
C4			CC73FCH1H060D	CHIP C 6.0PF D		
C5			CC73FCH1H070D	CHIP C 7.0PF D		

E: Scandinavia & Europe K: USA P: Canada W: Europe

U: PX(Far East, Hawaii) T: England M: Other Areas

UE: AAFES(Europe) X: Australia

△ indicates safety critical components.

## PARTS LIST

× New Parts  
 Parts without Parts No. are not supplied.  
 Les articles non mentionnés dans le Parts No. ne sont pas fournis.  
 Teile ohne Parts No. werden nicht geliefert.

Ref. No. 参照番号	Address 位置	New Parts 新	Parts No. 部品番号	Description 部品名 / 規格	Desti- nation 仕 向	Re- marks 備考
C6 C7 C8 C9 TC1			CK73FB1H102K CC73FCH1H180J CC73FCH1H050C CK73FB1H102K C05-0031-15	CHIP C 1000PF K CHIP C 18PF J CHIP C 5.0PF C CHIP C 1000PF K TRIMMING CAP (10P)		
-			E23-0464-05	TEST PIN		
-		*	F11-1018-04	SHIELDING COVER(VCSA COVER)		
-		*	F11-1021-04	SHIELDING CASE		
-			F20-0563-14	INSULATING BOARD		
L1		*	L33-0690-05	CHØKE COIL (3.3UH)		
L2		*	L34-2300-05	COIL (5.5T)		
R1			RK73FB2A103J	CHIP R 10K J 1/10W		
R2			RK73FB2A331J	CHIP R 330 J 1/10W		
R3			RK73FB2A473J	CHIP R 47K J 1/10W		
R4			RK73FB2A470J	CHIP R 47 J 1/10W		
R5			RK73FB2A102J	CHIP R 1.0K J 1/10W		
D1			1SV50	VARI CAP DIØDE		
Q1			2SK125	FET		
Q2			2SC2714(Y)	CHIP TRANSISTØR		
<b>10.24MHz OSC (X58-3060-00)</b>						
C1 C2 C3 C4 C5	.6		CK73FB1H103K CC73FCH1H390J CC73FCH1H040C CC73FTH1H220J CC73FCH1H151J	CHIP C 0.010UF K CHIP C 39PF J CHIP C 4.0PF C CHIP C 150PF J		
C7	.8		CK73FB1H103K	CHIP C 0.010UF K		
TC1		*	C05-0344-05	TRIMMING CAP (30P)		
-		*	E23-0486-05	TERMINAL		
-		*	F11-1055-05	SHIELDING CASE		
-		*	G13-0841-04	CUSHION		
X1		*	L77-1332-05	CRYSTAL RESONATOR(10.24MHZ)		
R1			RK73FB2A330J	CHIP R 33 J 1/10W		
R2			RK73FB2A223J	CHIP R 22K J 1/10W		
R3			RK73FB2A333J	CHIP R 33K J 1/10W		
R4			RK73FB2A102J	CHIP R 1.0K J 1/10W		
R5			RK73FB2A222J	CHIP R 2.2K J 1/10W		
R6			RK73FB2A104J	CHIP R 100K J 1/10W		
R7			RK73FB2A681J	CHIP R 680 J 1/10W		
Q1			2SC2715(Y)	CHIP TRANSISTØR		
Q2			2SC2712(Y)	CHIP TRANSISTØR		
<b>RIT (X58-3070-00)</b>						
C1 C2 C3 C4 C6	.5		CK73FB1H103K CC73FRH1H100D CC73FRH1H300J CC73FCH1H151J CK73FB1H102K	CHIP C 0.010UF K CHIP C 10PF D CHIP C 30PF J CHIP C 150PF J CHIP C 1000PF K		
TC1		*	C05-0345-05	TRIMMING CAP (10P)		
J1			E40-5047-05	PIN CONNECTØR (4P)		

E: Scandinavia & Europe K: USA P: Canada W: Europe  
 U: PX(Far East, Hawaii) T: England M: Other Areas  
 UE: AAFES(Europe) X: Australia

⚠ indicates safety critical components.

# TR-851A/E

## PARTS LIST

× New Parts

Parts without Parts No. are not supplied.

Les articles non mentionnés dans le Parts No. ne sont pas fournis.

Telle ohne Parts No. werden nicht geliefert.

Ref. No. 参照番号	Address 位置	New Parts 新	Parts No. 部品番号	Description 部品名/規格	Desti- nation 仕向	Re- marks 備考
-		*	F11-1056-04	SHIELDING CASE		
-		*	F11-1058-04	SHIELDING COVER		
L1			L33-0648-05	CHØKE COIL (4.7U)		
L2		*	L34-4037-05	COIL		
X1		*	L77-1331-05	CRYSTAL RESONATOR(15.266MHZ)		
R1			RK73FB2A223J	CHIP R 22K J 1/10W		
R2			RK73FB2A562J	CHIP R 5.6K J 1/10W		
R3			RK73FB2A682J	CHIP R 6.8K J 1/10W		
R4			RK73FB2A221J	CHIP R 220 J 1/10W		
R5			RK73FB2A561J	CHIP R 560 J 1/10W		
D1			1SV153	VARI CAP DIODE		
Q1			2SC2715(Y)	CHIP TRANSISTOR		
-6V DC-DC (X59-1100-00)						
E1	,2		CK73FB1H222K	CHIP C 2200PF K		
-			E23-0471-05	TERMINAL		
JR1	-3		R92-0670-05	CHIP R 0 ØHM		
R1			RK73FB2A272J	CHIP R 2.7K J 1/10W		
R2	,3		RK73FB2A223J	CHIP R 22K J 1/10W		
R4			RK73FB2A473J	CHIP R 47K J 1/10W		
R5			RK73FB2A471J	CHIP R 470 J 1/10W		
D1			1SS226	CHIP DIODE		
Q1	,2		2SC2712(Y)	CHIP TRANSISTOR		
Q3			2SA1162(Y)	CHIP TRANSISTOR		
AF PRE AMP (X59-1110-00)						
C1			CK73FB1H103K	CHIP C 0.010UF K		
C2			CK73FB1H392K	CHIP C 3900PF K		
C3			CC73FCH1H101J	CHIP C 100PF J		
C4			CK73FB1H471K	CHIP C 470PF K		
-			E23-0471-05	TERMINAL		
JR1	,2		R92-0670-05	CHIP R 0 ØHM		
R1			RK73FB2A123J	CHIP R 12K J 1/10W		
R2			RK73FB2A473J	CHIP R 47K J 1/10W		
R3			RK73FB2A272J	CHIP R 2.7K J 1/10W		
R4			RK73FB2A151J	CHIP R 150 J 1/10W		
R5			RK73FB2A472J	CHIP R 4.7K J 1/10W		
R6			RK73FB2A562J	CHIP R 5.6K J 1/10W		
R7			RK73FB2A153J	CHIP R 15K J 1/10W		
R8			RK73FB2A105J	CHIP R 1.0M J 1/10W		
R9			RK73FB2A562J	CHIP R 5.6K J 1/10W		
Q1	,2		2SC2712(Y)	CHIP TRANSISTOR		
SQUELCH SWITCH (X59-1120-00)						
-			E23-0471-05	TERMINAL		
R1	-3		RK73FB2A103J	CHIP R 10K J 1/10W		
R4	,5		RK73FB2A223J	CHIP R 22K J 1/10W		
R6			RK73FB2A474J	CHIP R 470K J 1/10W		
R7			RK73FB2A472J	CHIP R 4.7K J 1/10W		
D1	,2		1SS184	CHIP DIODE		
Q1	-3		2SC2712(Y)	CHIP TRANSISTOR		

E: Scandinavia & Europe K: USA P: Canada W: Europe

U: PX(Far East, Hawaii) T: England M: Other Areas

UE: AAFES(Europe) X: Australia

△ indicates safety critical components.



## PARTS LIST

\* New Parts

Parts without Parts No. are not supplied.

Les articles non mentionnés dans le Parts No. ne sont pas fournis.

Telle ohne Parts No. werden nicht geliefert.

Ref. No.	Address	New Parts	Parts No.	Description	Desti-nation	Re-marks
参照番号	位置	新	部品番号	部品名/規格	仕向	備考
<b>CW BREAK IN (X59-1130-00)</b>						
-			E23-0471-05	TERMINAL		
R1			RK73FB2A563J	CHIP R 56K J 1/10W		
R2			RK73FB2A333J	CHIP R 33K J 1/10W		
R3			RK73FB2A103J	CHIP R 10K J 1/10W		
R4			RK73FB2A222J	CHIP R 2.2K J 1/10W		
R5			RK73FB2A103J	CHIP R 10K J 1/10W		
R6			RK73FB2A153J	CHIP R 15K J 1/10W		
R7			RK73FB2A682J	CHIP R 6.8K J 1/10W		
R8			RK73FB2A103J	CHIP R 10K J 1/10W		
R9			RK73FB2A222J	CHIP R 2.2K J 1/10W		
Q1			DTA114EK	DIGITAL TRANSISTOR		
Q2	-4		2SC2712(Y)	CHIP TRANSISTOR		
<b>MIC AMP (X59-3000-01)</b>						
C1			CC73FCH1H101J	CHIP C 100PF J		
C2			CK73FB1H561K	CHIP C 560PF K		
C3			CC73FCH1H390J	CHIP C 39PF J		
C4			CK73FB1H102K	CHIP C 1000PF K		
C5			CK73FB1E223K	CHIP C 0.022UF K		
-			E23-0471-05	TERMINAL		
JR1			R92-0670-05	CHIP R 0.6HM		
R1			RK73FB2A105J	CHIP R 1.0M J 1/10W		
R2			RK73FB2A823J	CHIP R 82K J 1/10W		
R3			RK73FB2A562J	CHIP R 5.6K J 1/10W		
R4			RK73FB2A472J	CHIP R 4.7K J 1/10W		
R5	-7		RK73FB2A224J	CHIP R 220K J 1/10W		
R8			RK73FB2A182J	CHIP R 1.8K J 1/10W		
R9			RK73FB2A104J	CHIP R 100K J 1/10W		
IC1			NJM4558M	IC(8P AMP X2)		
Q1			2SC2712(Y)	CHIP TRANSISTOR		
<b>COMPOSITE UNIT (RX) (X60-1320-01)</b>						
C1			CC73FCH1H040C	CHIP C 4.0PF C		
C2			C90-0868-05	ELECTR0 10UF 16WV		
C3			CK73FB1E223K	CHIP C 0.022UF K		
C4			CC73FCH1H470J	CHIP C 47PF J		
C5			CK73FB1E223K	CHIP C 0.022UF K		
C6			CC73FSL1H101J	CHIP C 100PF J		
C7	.8		CK73FB1E223K	CHIP C 0.022UF K		
C9			CK73FB1E223K	CHIP C 0.022UF K		
C10			CK73FB1H102K	CHIP C 1000PF K		
C11	-16		CK73FB1E223K	CHIP C 0.022UF K		
C17			CC73FCH1H470J	CHIP C 47PF J		
C18	.19		CK73FB1E223K	CHIP C 0.022UF K		
C20			CC73FCH1H100D	CHIP C 10PF D		
C21			CK73FB1E223K	CHIP C 0.022UF K		
C22			CK73FB1H103K	CHIP C 0.010UF K		
C23			CC73FCH1H220J	CHIP C 22PF J		
C24			CK73EB1E473K	CHIP C 0.047UF K		
C25	-28		CK73FB1E223K	CHIP C 0.022UF K		
C29			CK73FB1H471K	CHIP C 470PF K		
C30			CK73FB1E223K	CHIP C 0.022UF K		

E: Scandinavia & Europe K: USA P: Canada W: Europe

U: PX(Far East, Hawaii) T: England M: Other Areas

UE: AAFES(Europe) X: Australia

△ indicates safety critical components.

# TR-851A/E

## PARTS LIST

× New Parts  
 Parts without Parts No. are not supplied.  
 Les articles non mentionnés dans le Parts No. ne sont pas fournis.  
 Teile ohne Parts No. werden nicht geliefert.

Ref. No. 参照番号	Address 位置	New Parts 新	Parts No. 部品番号	Description 部品名/規格	Desti- nation 仕向	Re- marks 備考
C31			CK73FB1H103K	CHIP C 0.010UF K		
C32			CC73FCH1H150J	CHIP C 15PF J		
C33 -35			CK73FB1E223K	CHIP C 0.022UF K		
C36			C90-0868-05	ELECTRØ 10UF 16WV		
C37			CC73FSL1H331J	CHIP C 330PF J		
C38			CK73FB1E223K	CHIP C 0.022UF K		
C39			CS15E1E010M	TANTAL 1.0UF 25WV		
C40			CK73FB1E223K	CHIP C 0.022UF K		
C41 ,42			CK73FB1H102K	CHIP C 1000PF K		
C43			CK73FB1H103K	CHIP C 0.010UF K		
C44			CK73FB1E223K	CHIP C 0.022UF K		
C45			CC73FSL1H101J	CHIP C 100PF J		
C46 ,47			CK73FB1E223K	CHIP C 0.022UF K		
C48			CK73FB1H103K	CHIP C 0.010UF K		
C49			CK73FB1E223K	CHIP C 0.022UF K		
C50			CE04CW1A470M	ELECTRØ 47UF 10WV		
C51 ,52			CK73EB1E104K	CHIP C 0.10UF K		
C53			CC73FCH1H030C	CHIP C 3.0PF C		
C54			CK73FB1H102K	CHIP C 1000PF K		
C55 ,56		*	CK73EB1E104K	CHIP C 0.10UF K		
C57 ,58			CK73FB1H102K	CHIP C 1000PF K		
C59			CC73FCH1H220J	CHIP C 22PF J		
C60			CK73FB1H472K	CHIP C 4700PF K		
C61			CK73FB1H102K	CHIP C 1000PF K		
C62			CC73FCH1H220J	CHIP C 22PF J		
C63			CK73FB1H102K	CHIP C 1000PF K		
C64			CK73EB1H153K	CHIP C 0.015UF K		
C65			CC73FSL1H121J	CHIP C 120PF J		
C66			CK73FB1H472K	CHIP C 4700PF K		
C67			CK73EB1E104K	CHIP C 0.10UF K		
C68			CK73FB1E223K	CHIP C 0.022UF K		
C69			CK73EB1E473K	CHIP C 0.047UF K		
C70 ,71			CK73FB1E223K	CHIP C 0.022UF K		
C72			CC73FSL1H331J	CHIP C 330PF J		
C73			CC73FCH1H470J	CHIP C 47PF J		
C74			CK73FB1E223K	CHIP C 0.022UF K		
C75			CC73FCH1H470J	CHIP C 47PF J		
C76			CC73FCH1H030C	CHIP C 3.0PF C		
C77			CS15E1E010M	TANTAL 1.0UF 25WV		
C78 ,79			CK73FB1H102K	CHIP C 1000PF K		
C80			CE04CW1A470M	ELECTRØ 47UF 10WV		
C81			C90-0478-05	ELECTRØ 10UF 16WV		
C82			C90-0824-05	ELECTRØ 1UF 50WV		
C83			CK73FB1H102K	CHIP C 1000PF K		
C84			CC45UJ1H020C	CERAMIC 2.0PF C		
C85			CC45UJ1H100D	CERAMIC 10PF D		
C86			CK73FB1H103K	CHIP C 0.010UF K		
C87 ,88			CC73FSL1H221J	CHIP C 220PF J		
C89			CK73FB1H103K	CHIP C 0.010UF K		
C90			CC73FCH1H030C	CHIP C 3.0PF C		
C91			CC73FCH1H050C	CHIP C 5.0PF C		
C92			CC73FCH1H470J	CHIP C 47PF J		
C93 -95			CK73FB1E223K	CHIP C 0.022UF K		
C96			CK73FB1H102K	CHIP C 1000PF K		
C97 ,98			CC73FSL1H101J	CHIP C 100PF J		

E: Scandinavia & Europe K: USA P: Canada W: Europe

U: PX(Far East, Hawaii) T: England M: Other Areas

UE: AAFES(Europe) X: Australia

⚠ indicates safety critical components.

## PARTS LIST

× New Parts  
 Parts without Parts No. are not supplied.  
 Les articles non mentionnés dans le Parts No. ne sont pas fournis.  
 Teile ohne Parts No. werden nicht geliefert.

Ref. No. 参照番号	Address 位置	New Parts 新	Parts No. 部品番号	Description 部品名 / 規格	Desti- nation 仕 向	Re- marks 備考
C99			CK73FB1H102K	CHIP C 1000PF K		
C100			CC73FSL1H101J	CHIP C 100PF J		
C101			CE04CW1A470M	ELECTRØ 47UF 10WV		
C102			C90-0824-05	ELECTRØ 1UF 50WV		
C103			C90-0478-05	ELECTRØ 10UF 16WV		
C104			CK73FB1H103K	CHIP C 0.010UF K		
C105, 106			C90-0824-05	ELECTRØ 1UF 50WV		
C107			CK73FB1H103K	CHIP C 0.010UF K		
C108			CE04CW1A470M	ELECTRØ 47UF 10WV		
C109			C90-0478-05	ELECTRØ 10UF 16WV		
C110			C90-0824-05	ELECTRØ 1UF 50WV		
C111			CK73FB1H103K	CHIP C 0.010UF K		
C112			CK73FB1H102K	CHIP C 1000PF K		
C113			CK73FB1E223K	CHIP C 0.022UF K		
C114			CE04CW1A330M	ELECTRØ 33UF 10WV		
C115			CK73FB1E223K	CHIP C 0.022UF K		
C116-118			CK73FB1H103K	CHIP C 0.010UF K		
C119			CC73FCH1H470J	CHIP C 47PF J		
C120			CK73FB1E223K	CHIP C 0.022UF K		
C121			CC73FCH1H470J	CHIP C 47PF J		
C122			CC73FCH1H050C	CHIP C 5.0PF C		
C123, 124			CK73FB1E223K	CHIP C 0.022UF K		
C125			CK73FB1H103K	CHIP C 0.010UF K		
C126, 127			CK73FB1H102K	CHIP C 1000PF K		
C128			C90-2033-05	ELECTRØ 1000UF 16WV		
C129			CK73FB1E223K	CHIP C 0.022UF K		
C130			CK73FB1H102K	CHIP C 1000PF K		
C131, 132			CK73FB1H103K	CHIP C 0.010UF K		
C133			CE04CW1A470M	ELECTRØ 47UF 10WV		
C134			C90-0478-05	ELECTRØ 10UF 16WV		
C135			CE04W1C101M	ELECTRØ 100UF 16WV		
C136			C90-0820-05	ELECTRØ 470UF 16WV		
C137			CE04CW1C470M	ELECTRØ 47UF 16WV		
C138, 139			CE04W1C330M	ELECTRØ 33UF 16WV		
C140, 141			CK73FB1H103K	CHIP C 0.010UF K		
C142			CS15E1C2R2M	TANTAL 2.2UF 16WV		
C143			CS15E1C4R7M	TANTAL 4.7UF 16WV		
C144			CS15E1C100M	TANTAL 10UF 16WV		
C145			C90-0868-05	ELECTRØ 10UF 16WV		
C146			C90-0478-05	ELECTRØ 10UF 16WV		
C147			CK73EB1E473K	CHIP C 0.047UF K		
C148			CE04CW1A470M	ELECTRØ 47UF 10WV		
C149, 150		*	CK73EB1E104K	CHIP C 0.10UF K		
C151			C90-0478-05	ELECTRØ 10UF 16WV		
C152			CK73FB1H102K	CHIP C 1000PF K		
C153			CK73FB1H103K	CHIP C 0.010UF K		
C154			CK73FB1H471K	CHIP C 470PF K		
C155-157			CK73FB1E223K	CHIP C 0.022UF K		
C158			CK73FB1H471K	CHIP C 470PF K		
C159			CK73FB1E223K	CHIP C 0.022UF K		
TC1			C05-0030-15	TRIMMING CAP (20P)		
TC2			C05-0062-05	TRIMMING CAP (6P)		
J1			E40-3240-05	PIN ASSY (5P)		
J2			E40-3238-05	PIN ASSY (3P)		

E: Scandinavia & Europe K: USA P: Canada W: Europe  
 U: PX(Far East, Hawaii) T: England M: Other Areas  
 UE: AAFES(Europe) X: Australia

⚠ indicates safety critical components.

# TR-851A/E

## PARTS LIST

\* New Parts

Parts without Parts No. are not supplied.

Les articles non mentionnés dans le Parts No. ne sont pas fournis.

Teile ohne Parts No. werden nicht geliefert.

Ref. No. 参照番号	Address 位置	New Parts 新	Parts No. 部品番号	Description 部品名 / 規格	Desti- nation 仕 向	Re- marks 備考
J3			E40-3241-05	PIN ASSY (6P)		
J4			E40-5067-05	PIN ASSY (10P)		
J5			E40-3242-05	PIN ASSY (7P)		
J6			E40-3238-05	PIN ASSY (3P)		
J7			E40-3241-05	PIN ASSY (6P)		
J8 ,9			E40-3237-05	PIN ASSY (2P)		
J10 ,11			E40-3241-05	PIN ASSY (6P)		
J12			E40-3237-05	PIN ASSY (2P)		
J13			E40-0273-05	PIN ASSY (2P)		
JP1			E31-0381-05	CONNECTING WIRE(10MM)		
JP2		*	E31-0302-05	CONNECTING WIRE(20MM)		
JP3			E31-0381-05	CONNECTING WIRE(10MM)		
JP4		*	E31-0302-05	CONNECTING WIRE(20MM)		
JP5		*	E31-1960-05	CONNECTING WIRE(15MM)		
JP6			E31-0381-05	CONNECTING WIRE(10MM)		
JP7		*	E31-0302-05	CONNECTING WIRE(20MM)		
JP8 -11		*	E31-1960-05	CONNECTING WIRE(15MM)		
JP12,13		*	E31-0302-05	CONNECTING WIRE(20MM)		
JP14			E31-0381-05	CONNECTING WIRE(10MM)		
JP15		*	E31-0302-05	CONNECTING WIRE(20MM)		
JP16		*	E31-1960-05	CONNECTING WIRE(15MM)		
JP17			E31-1449-05	CONNECTING WIRE(7.5MM)		
JP18			E31-1959-05	CONNECTING WIRE(12.5MM)		
JP19		*	E31-1960-05	CONNECTING WIRE(15MM)		
JP20			E31-1449-05	CONNECTING WIRE(7.5MM)		
JP21			E31-0381-05	CONNECTING WIRE(10MM)		
JP22,23		*	E31-1960-05	CONNECTING WIRE(15MM)		
JP24		*	E31-0302-05	CONNECTING WIRE(20MM)		
JP25			E31-1449-05	CONNECTING WIRE(7.5MM)		
JP26		*	E31-0302-05	CONNECTING WIRE(20MM)		
TP1 -4			E23-0465-05	TERMINAL		
-		*	F02-0421-04	HEAT SINK(CAP/ADDITION TYPE)		
-			G02-0535-04	LEAF SPRING,FLAT SPRING		
CF1			L72-0315-05	CERAMIC FILTER (CFW455F)		
L1 -7			L30-0281-15	IFT		
L8			L30-0503-05	IFT		
L9			L40-4791-14	SMALL FIXED INDUCTOR(4.7U)		
L10			L30-0503-05	IFT		
L11			L40-1021-14	SMALL FIXED INDUCTOR(1MH)		
L13			L30-0503-05	IFT		
L14			L40-1021-14	SMALL FIXED INDUCTOR(1MH)		
L15			L30-0503-05	IFT		
L16 ,17			L40-1021-14	SMALL FIXED INDUCTOR(1MH)		
L18		*	L33-0691-05	CHOKE COIL (15U)		
L19			L40-1011-16	SMALL FIXED INDUCTOR(100U)		
L20			L40-1021-14	SMALL FIXED INDUCTOR(1MH)		
L21			L30-0515-05	IFT		
L22			L15-0306-05	LOW-FREQUENCY CHOKE COIL		
L23			L40-1021-14	SMALL FIXED INDUCTOR(1MH)		
X1		*	L77-1305-05	CRYSTAL RESONATOR(10.695)		
XF1			L71-0249-05	CRYSTAL FILTER (10F2.2S)		
-			N35-3006-46	BINDING HEAD MACHINE SCREW		

E: Scandinavia & Europe K: USA P: Canada W: Europe

U: PX(Far East, Hawaii) T: England M: Other Areas

UE: AAFES(Europe) X: Australia

▲ indicates safety critical components.

## PARTS LIST

※ New Parts

Parts without Parts No. are not supplied.

Les articles non mentionnés dans le Parts No. ne sont pas fournis.

Telle ohne Parts No. werden nicht geliefert.

Ref. No. 参照番号	Address 位置	New Parts 新	Parts No. 部品番号	Description 部品名 / 規格	Desti- nation 仕向	Re- marks 備考
-			R92-0150-05	JUMPER REST 0 0HM		
JR1 -4			R92-0670-05	CHIP R 0 0HM		
JR6 ,7			R92-0670-05	CHIP R 0 0HM		
JR9 -13			R92-0670-05	CHIP R 0 0HM		
JR50-58			R92-0679-05	FIXED RESISTOR		
JR6D,61			R92-0670-05	CHIP R 0 0HM		
JR62-68			R92-0679-05	FIXED RESISTOR		
JR70-77			R92-0679-05	FIXED RESISTOR		
R1			RK73FB2A102J	CHIP R 1.0K J 1/10W		
R2			RK73FB2A103J	CHIP R 10K J 1/10W		
R3			RK73FB2A273J	CHIP R 27K J 1/10W		
R4			RK73FB2A105J	CHIP R 1.0M J 1/10W		
R5			RK73FB2A331J	CHIP R 330 J 1/10W		
R6			RK73FB2A101J	CHIP R 100 J 1/10W		
R7 -10			RK73FB2A332J	CHIP R 3.3K J 1/10W		
R11			RK73FB2A103J	CHIP R 10K J 1/10W		
R12			RK73FB2A102J	CHIP R 1.0K J 1/10W		
R14			RK73FB2A331J	CHIP R 330 J 1/10W		
R15			RK73FB2A223J	CHIP R 22K J 1/10W		
R16			RK73EB2B101J	CHIP R 100 J 1/8W		
R17			RK73FB2A103J	CHIP R 10K J 1/10W		
R18			RK73FB2A102J	CHIP R 1.0K J 1/10W		
R20			RK73FB2A331J	CHIP R 330 J 1/10W		
R21			RK73FB2A562J	CHIP R 5.6K J 1/10W		
R22			RK73EB2B101J	CHIP R 100 J 1/8W		
R23 ,24			RK73FB2A221J	CHIP R 220 J 1/10W		
R25			RK73FB2A562J	CHIP R 5.6K J 1/10W		
R26			RK73FB2A472J	CHIP R 4.7K J 1/10W		
R27 ,28			RK73FB2A153J	CHIP R 15K J 1/10W		
R29			RK73FB2A105J	CHIP R 1.0M J 1/10W		
R30			RK73FB2A102J	CHIP R 1.0K J 1/10W		
R31			RK73FB2A101J	CHIP R 100 J 1/10W		
R32			RK73FB2A223J	CHIP R 22K J 1/10W		
R33			RK73FB2A682J	CHIP R 6.8K J 1/10W		
R34			RK73FB2A681J	CHIP R 680 J 1/10W		
R35			RK73FB2A102J	CHIP R 1.0K J 1/10W		
R36			RK73FB2A473J	CHIP R 47K J 1/10W		
R37			RK73FB2A101J	CHIP R 100 J 1/10W		
R38			RK73FB2A333J	CHIP R 33K J 1/10W		
R39			RK73FB2A103J	CHIP R 10K J 1/10W		
R40			RK73FB2A182J	CHIP R 1.8K J 1/10W		
R41			RK73FB2A103J	CHIP R 10K J 1/10W		
R43			RK73FB2A392J	CHIP R 3.9K J 1/10W		
R44 ,45			RK73FB2A102J	CHIP R 1.0K J 1/10W		
R46			RK73FB2A682J	CHIP R 6.8K J 1/10W		
R47			RK73FB2A182J	CHIP R 1.8K J 1/10W		
R48			RK73FB2A473J	CHIP R 47K J 1/10W		
R49			RK73FB2A333J	CHIP R 33K J 1/10W		
R50 ,51			RK73FB2A104J	CHIP R 100K J 1/10W		
R52			RK73FB2A473J	CHIP R 47K J 1/10W		
R53			RK73FB2A103J	CHIP R 10K J 1/10W		
R54			RK73FB2A153J	CHIP R 15K J 1/10W		
R55			RK73FB2A105J	CHIP R 1.0M J 1/10W		
R56			RK73FB2A823J	CHIP R 82K J 1/10W		
R57			RK73FB2A473J	CHIP R 47K J 1/10W		

E: Scandinavia & Europe K: USA P: Canada W: Europe

U: PX(Far East, Hawaii) T: England M: Other Areas

UE: AAFES(Europe) X: Australia

▲ indicates safety critical components.

# TR-851A/E

## PARTS LIST

× New Parts  
 Parts without Parts No. are not supplied.  
 Les articles non mentionnés dans le Parts No. ne sont pas fournis.  
 Teile ohne Parts No. werden nicht geliefert.

Ref. No. 参照番号	Address 位置	New Parts 新	Parts No. 部品番号	Description 部品名 / 規格	Desti- nation 仕向	Re- marks 備考
R58			RK73FB2A334J	CHIP R 330K J 1/10W		
R59			RK73FB2A224J	CHIP R 220K J 1/10W		
R60			RK73FB2A103J	CHIP R 10K J 1/10W		
R61			RK73FB2A332J	CHIP R 3.3K J 1/10W		
R62			RK73FB2A102J	CHIP R 1.0K J 1/10W		
R63			RK73FB2A104J	CHIP R 100K J 1/10W		
R64			RK73FB2A681J	CHIP R 680 J 1/10W		
R65			RK73FB2A222J	CHIP R 2.2K J 1/10W		
R66			RK73FB2A334J	CHIP R 330K J 1/10W		
R67			RK73FB2A103J	CHIP R 10K J 1/10W		
R68			RK73FB2A104J	CHIP R 100K J 1/10W		
R69			RK73FB2A333J	CHIP R 33K J 1/10W		
R70			RK73FB2A105J	CHIP R 1.0M J 1/10W		
R71			RK73FB2A103J	CHIP R 10K J 1/10W		
R72			RK73FB2A224J	CHIP R 220K J 1/10W		
R73			RK73FB2A152J	CHIP R 1.5K J 1/10W		
R74			RK73FB2A222J	CHIP R 2.2K J 1/10W		
R75			RK73FB2A682J	CHIP R 6.8K J 1/10W		
R76			RK73FB2A105J	CHIP R 1.0M J 1/10W		
R77			RK73FB2A273J	CHIP R 27K J 1/10W		
R78			RK73FB2A334J	CHIP R 330K J 1/10W		
R79			RK73FB2A101J	CHIP R 100 J 1/10W		
R80			RK73FB2A273J	CHIP R 27K J 1/10W		
R81			RK73FB2A683J	CHIP R 68K J 1/10W		
R82			RK73FB2A103J	CHIP R 10K J 1/10W		
R83			RK73FB2A183J	CHIP R 18K J 1/10W		
R84			RK73FB2A102J	CHIP R 1.0K J 1/10W		
R85			RK73FB2A104J	CHIP R 100K J 1/10W		
R86			RK73FB2A101J	CHIP R 100 J 1/10W		
R87			RK73FB2A331J	CHIP R 330 J 1/10W		
R88			RK73FB2A152J	CHIP R 1.5K J 1/10W		
R89			RK73FB2A103J	CHIP R 10K J 1/10W		
R90			RK73FB2A472J	CHIP R 4.7K J 1/10W		
R91			RK73FB2A103J	CHIP R 10K J 1/10W		
R92			RK73FB2A473J	CHIP R 47K J 1/10W		
R93			RK73FB2A103J	CHIP R 10K J 1/10W		
R94			RK73FB2A102J	CHIP R 1.0K J 1/10W		
R94			RK73FB2A102J	CHIP R 1.0K J 1/10W		
R95			RK73FB2A153J	CHIP R 15K J 1/10W		
R96			RK73FB2A101J	CHIP R 100 J 1/10W		
R97			RK73FB2A472J	CHIP R 4.7K J 1/10W		
R98			RK73FB2A102J	CHIP R 1.0K J 1/10W		
R99			RK73FB2A104J	CHIP R 100K J 1/10W		
R100			RK73FB2A223J	CHIP R 22K J 1/10W		
R101			RK73EB2B101J	CHIP R 100 J 1/8W		
R102			RK73FB2A472J	CHIP R 4.7K J 1/10W		
R103			RK73FB2A101J	CHIP R 100 J 1/10W		
R104			RK73FB2A102J	CHIP R 1.0K J 1/10W		
R106			RK73FB2A471J	CHIP R 470 J 1/10W		
R107			RK73FB2A473J	CHIP R 47K J 1/10W		
R108			RK73FB2A223J	CHIP R 22K J 1/10W		
R109			RK73EB2B101J	CHIP R 100 J 1/8W		
R110			RK73FB2A222J	CHIP R 2.2K J 1/10W		
R111			RK73FB2A221J	CHIP R 220 J 1/10W		
R112			RK73FB2A102J	CHIP R 1.0K J 1/10W		

E: Scandinavia & Europe K: USA P: Canada W: Europe

U: PX(Far East, Hawaii) T: England M: Other Areas

UE: AAFES(Europe) X: Australia

△ indicates safety critical components.

## PARTS LIST

× New Parts  
 Parts without Parts No. are not supplied.  
 Les articles non mentionnés dans le Parts No. ne sont pas fournis.  
 Teile ohne Parts No. werden nicht geliefert.

Ref. No. 参照番号	Address 位置	New Parts 新	Parts No. 部品番号	Description 部品名 / 規格	Desti- nation 仕向	Re- marks 備考
R113			RK73FB2A471J	CHIP R 470 J 1/10W		
R114			RK73FB2A224J	CHIP R 220K J 1/10W		
R115			RK73EB2B101J	CHIP R 100 J 1/8W		
R116			RK73FB2A472J	CHIP R 47K J 1/10W		
R117			RK73FB2A222J	CHIP R 2.2K J 1/10W		
R118			RK73FB2A332J	CHIP R 3.3K J 1/10W		
R119,120			RK73FB2A152J	CHIP R 1.5K J 1/10W		
R121,122			RK73FB2A101J	CHIP R 100 J 1/10W		
R123			RK73FB2A472J	CHIP R 4.7K J 1/10W		
R124			RK73FB2A102J	CHIP R 1.0K J 1/10W		
R125			RK73FB2A473J	CHIP R 47K J 1/10W		
R126			RD14CB2E2R2J	RD 2.2 J 1/4W		
R127			RK73FB2A103J	CHIP R 10K J 1/10W		
R128			RK73FB2A222J	CHIP R 2.2K J 1/10W		
R129			RK73FB2A103J	CHIP R 10K J 1/10W		
R130			RD14CB2E2R2J	RD 2.2 J 1/4W		
R131			RD14BB2C222J	RD 2.2K J 1/6W		
R132			RK73FB2A102J	CHIP R 1.0K J 1/10W		
R133			RK73FB2A472J	CHIP R 4.7K J 1/10W		
R134			RK73FB2A152J	CHIP R 1.5K J 1/10W		
R135			RK73FB2A102J	CHIP R 1.0K J 1/10W		
R136			RS14KB3D330J	FL-PROOF RS 33 J 2W		
R137			RD14BB2E2R2J	RD 2.2 J 1/4W		
R138			RK73FB2A221J	CHIP R 220 J 1/10W		
R139			RK73FB2A333J	CHIP R 33K J 1/10W		
R140			RK73FB2A103J	CHIP R 10K J 1/10W		
R141			RK73FB2A332J	CHIP R 3.3K J 1/10W		
R142			RK73FB2A104J	CHIP R 100 J 1/10W		
R143			RK73FB2A562J	CHIP R 5.6K J 1/10W		
R144			RK73FB2A102J	CHIP R 1.0K J 1/10W		
R145			RK73FB2A473J	CHIP R 47K J 1/10W		
R146			RK73FB2A222J	CHIP R 2.2K J 1/10W		
R147			RK73FB2A102J	CHIP R 1.0K J 1/10W		
R148			RK73FB2A103J	CHIP R 10K J 1/10W		
R149			RK73FB2A333J	CHIP R 33K J 1/10W		
R150			RK73FB2A102J	CHIP R 1.0K J 1/10W		
VR1		*	R12-3450-05	TRIMMING P8T. (20K)		
VR2		*	R12-1435-05	TRIMMING P8T. (2K)		
VR3		*	R12-3443-05	TRIMMING P8T. (10K)		
VR4		*	R12-7408-05	TRIMMING P8T. (500K)		
VR5 .6		*	R12-3450-05	TRIMMING P8T. (20K)		
VR7		*	R12-3443-05	TRIMMING P8T. (10K)		
VR8		*	R12-2413-05	TRIMMING P8T. (5K)		
VR9		*	R12-3443-05	TRIMMING P8T. (10K)		
VR10		*	R12-5420-05	TRIMMING P8T. (100K)		
VR11		*	R12-3443-05	TRIMMING P8T. (10K)		
VR12		*	R12-2413-05	TRIMMING P8T. (5K)		
VR13		*	R12-1428-05	TRIMMING P8T. (1K)		
VR14		*	R12-3444-05	TRIMMING P8T. (10K)		
D1		*	1SS272	CHIP DIODE		
D3 .4		*	1SS184	CHIP DIODE		
D5 .6		*	HSM88AS	CHIP DIODE		
D9		*	1SS181	CHIP DIODE		
D10 .11		*	1SS106	DIODE		

E: Scandinavia & Europe K: USA P: Canada W: Europe  
 U: PX(Far East, Hawaii) T: England M: Other Areas  
 UE: AAFES(Europe) X: Australia

▲ indicates safety critical components.

# TR-851A/E

## PARTS LIST

× New Parts  
 Parts without Parts No. are not supplied.  
 Les articles non mentionnés dans le Parts No. ne sont pas fournis.  
 Teile ohne Parts No. werden nicht geliefert.

Ref. No. 参照番号	Address 位置	New Parts 新	Parts No. 部品番号	Description 部品名/規格	Desti- nation 仕向	Re- marks 備考
D12 -15			1SS184	CHIP DIODE		
D16			1SS133	DIODE		
D17			1SS184	CHIP DIODE		
D18			1SS181	CHIP DIODE		
D19			1SS226	CHIP DIODE		
D20			1SS133	DIODE		
D21			1S2208	DIODE		
D22			1SS184	CHIP DIODE		
D23			1SS181	CHIP DIODE		
D24		*	1SS272	CHIP DIODE		
D26			1SS184	CHIP DIODE		
D27			1SS226	CHIP DIODE		
D28			1SS181	CHIP DIODE		
D29			MTZ11JC	ZENER DIODE		
D30			MTZ6.2JA	ZENER DIODE		
D31			1SS181	CHIP DIODE		
D32			HSM88AS	CHIP DIODE		
D33 ,34			1SS184	CHIP DIODE		
D35			1SS181	CHIP DIODE		
IC1			TA7302P	IC(FM IF)		
IC2			TA7761P	IC(FM IF)		
IC3			NJM4558D	IC(OP AMP X2)		
IC3			UPC4558C	IC(OP AMP X2)		
IC4			AN612	IC(BALANCE MODULATOR)		
IC5			UPC78M08H	IC(VOLTAGE REGULATOR/ +8V)		
Q1 -3			3SK73(GR)	FET		
Q4			2SK125	FET		
Q5			2SC2714(Y)	CHIP TRANSISTOR		
Q6			2SC2712(Y)	CHIP TRANSISTOR		
Q7			DTC114EK	DIGITAL TRANSISTOR		
Q8 ,9			2SC2712(Y)	CHIP TRANSISTOR		
Q10			DTA114EK	DIGITAL TRANSISTOR		
Q11			DTC114EK	DIGITAL TRANSISTOR		
Q12 ,13			2SC2712(Y)	CHIP TRANSISTOR		
Q14 ,15			2SK208(8)	CHIP FET		
Q16			2SA1162(Y)	CHIP TRANSISTOR		
Q17			DTC114EK	DIGITAL TRANSISTOR		
Q18 ,19			2SC2714(Y)	CHIP TRANSISTOR		
Q20			2SC2712(Y)	CHIP TRANSISTOR		
Q21			DTC114EK	DIGITAL TRANSISTOR		
Q22			DTA114EK	DIGITAL TRANSISTOR		
Q23			DTC114EK	DIGITAL TRANSISTOR		
Q24			3SK73(GR)	FET		
Q25 -27		*	2SC3324(G.B)	CHIP TRANSISTOR		
Q28 ,29			DTC114EK	DIGITAL TRANSISTOR		
Q30			2SA1115(E)	TRANSISTOR		
Q31			2SC2712(Y)	CHIP TRANSISTOR		
Q32			2SA1307(Y)	TRANSISTOR		
Q33			2SA1162(Y)	CHIP TRANSISTOR		
Q34			2SC3419(Y)	TRANSISTOR		
Q35			DTC114EK	DIGITAL TRANSISTOR		
Q36			2SC2712(Y)	CHIP TRANSISTOR		
TH1			112-202-2	THERMISTOR (2K)		
TH2			112-102-2	THERMISTOR (1K)		
TH3			112-103-2	THERMISTOR (10K)		

E: Scandinavia & Europe K: USA P: Canada W: Europe

U: PX(Far East, Hawaii) T: England M: Other Areas

UE: AAFES(Europe) X: Australia

⚠ indicates safety critical components.



## PARTS LIST

× New Parts  
 Parts without Parts No. are not supplied.  
 Les articles non mentionnés dans le Parts No. ne sont pas fournis.  
 Teile ohne Parts No. werden nicht geliefert.

Ref. No. 参照番号	Address 位置	New Parts 新	Parts No. 部品番号	Description 部品名 / 規格	Desti- nation 仕向	Re- marks 備考
-		*	X59-1100-00	-6V DC-DC UNIT		
-		*	X59-1110-00	AF PRE AMP UNIT		
-		*	X59-1120-00	SQL SW UNIT		
-		*	X59-3000-01	MIC AMP UNIT		

E: Scandinavia & Europe K: USA P: Canada W: Europe  
 U: PX(Far East, Hawaii) T: England M: Other Areas  
 UE: AAFES(Europe) X: Australia

⚠ indicates safety critical components.

### SEMICONDUCTOR

N : New Parts

Item	Re- marks	Parts No.	Item	Re- marks	Parts No.	Item	Re- marks	Parts No.
<b>Diode</b>		1N60PSPA	<b>LCD</b>	N	FSD-8168B	<b>Power Module IC</b>		M57745
		1S2208		N	FSD-8168G		N	7508HG-564-22
		1SS101	<b>Thermister</b>		112-102-2			AN612
		1SS106			112-103-2		N	BU4584B
		1SS133			112-202-2		N	DT5A143E
		1SS208			112-502-2		N	DT5C124E
		1SS226	<b>TR</b>		2SA1115(E)			L78N08
		1SS277			2SA1307(Y)			MB3712
		DSA3A1		2SC2458(Y)			NE555P	
		MI308	<b>Chip TR</b>		2SC2762			NJM78L05A
		MI407			2SC3419(Y)			NJM2930L-06B
		ND487C1-3R			2SA1162(Y)			NJM4558D
	<b>Vari-cap diode</b>		1SV50		2SC2712(Y)			NJM4558M
			1SV153		2SC2714(Y)		N	PST523C
	<b>Chip diode</b>		1SS181		2SC2715(Y)			SN16913P
		1SS184		2SC3098		TA7302P		
		1SS226		2SC3324(G,B)		TA7761P		
		1SS268		2SC3356		TC74HC390P		
		1SS272		3SK151(GR)		TC5082P-G		
<b>Zener diode</b>	N	DAN202(K)	<b>Digital TR</b>		DTA114EK		TC9172P	
	N	DAP202(K)		N	DTA114TK		μPC78M08H	
	HSM88AS	N		DTA143EK		μPC4558C		
	MTZ6.2JA		DTC114EK		μPD7507SCT-226			
	MTZ11JC		DTC124EK		μPD7514G-143-12			
<b>LED</b>	N	B30-0842-05	<b>FET</b>		2SK125			
	N	B30-0843-05			3SK73(GR)			
	N	B30-0844-05	<b>Chip FET</b>		2SK208(O)			
	N	B30-0846-05			3SK151(GR)			
	N	LN322GP			3SK179(L)			
				3SK184(S)				

# TR-851A/E

## EXPLODED VIEW

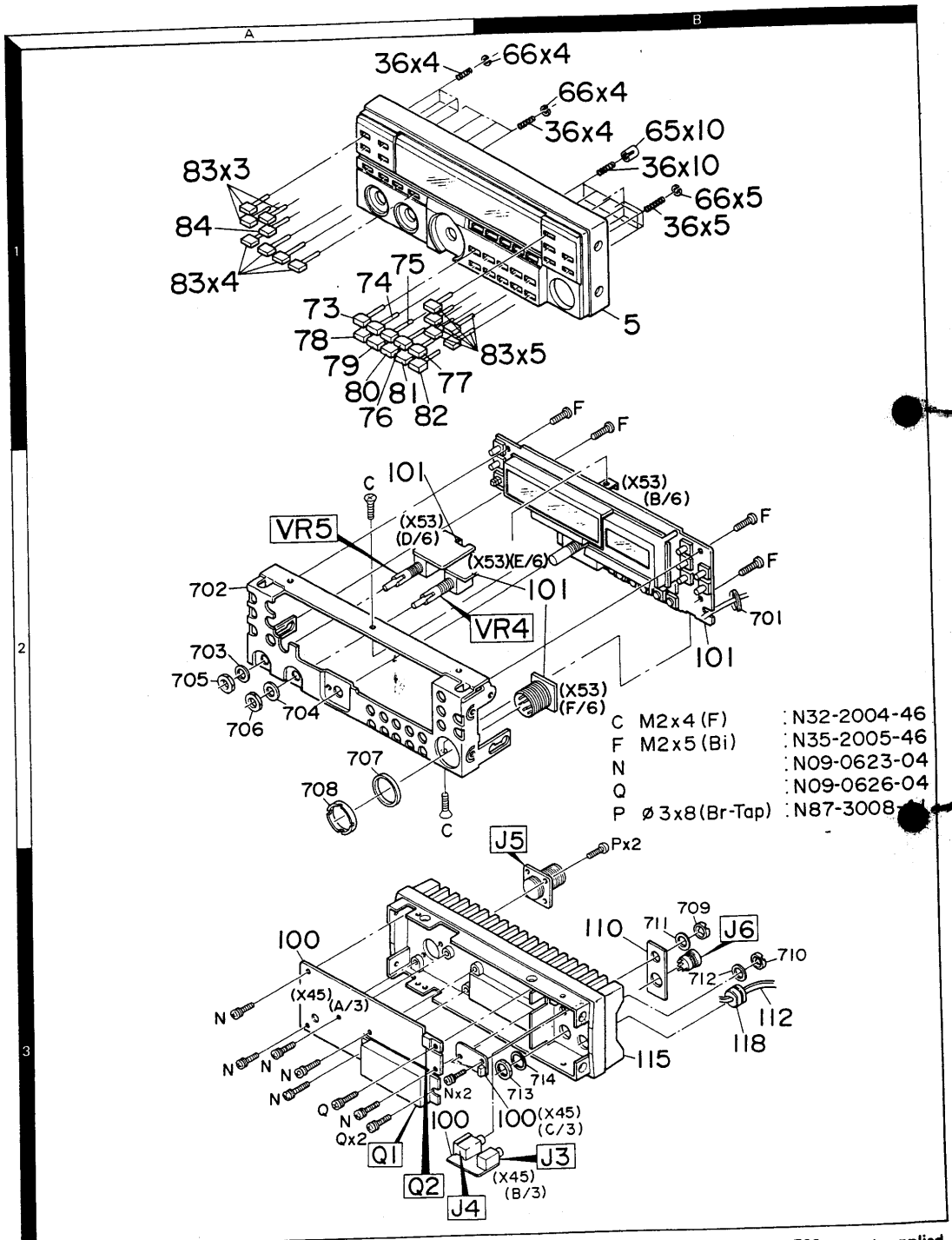

Parts with the exploded numbers larger than 700 are not supplied.

# TR-851A/E

## EXPLODED VIEW

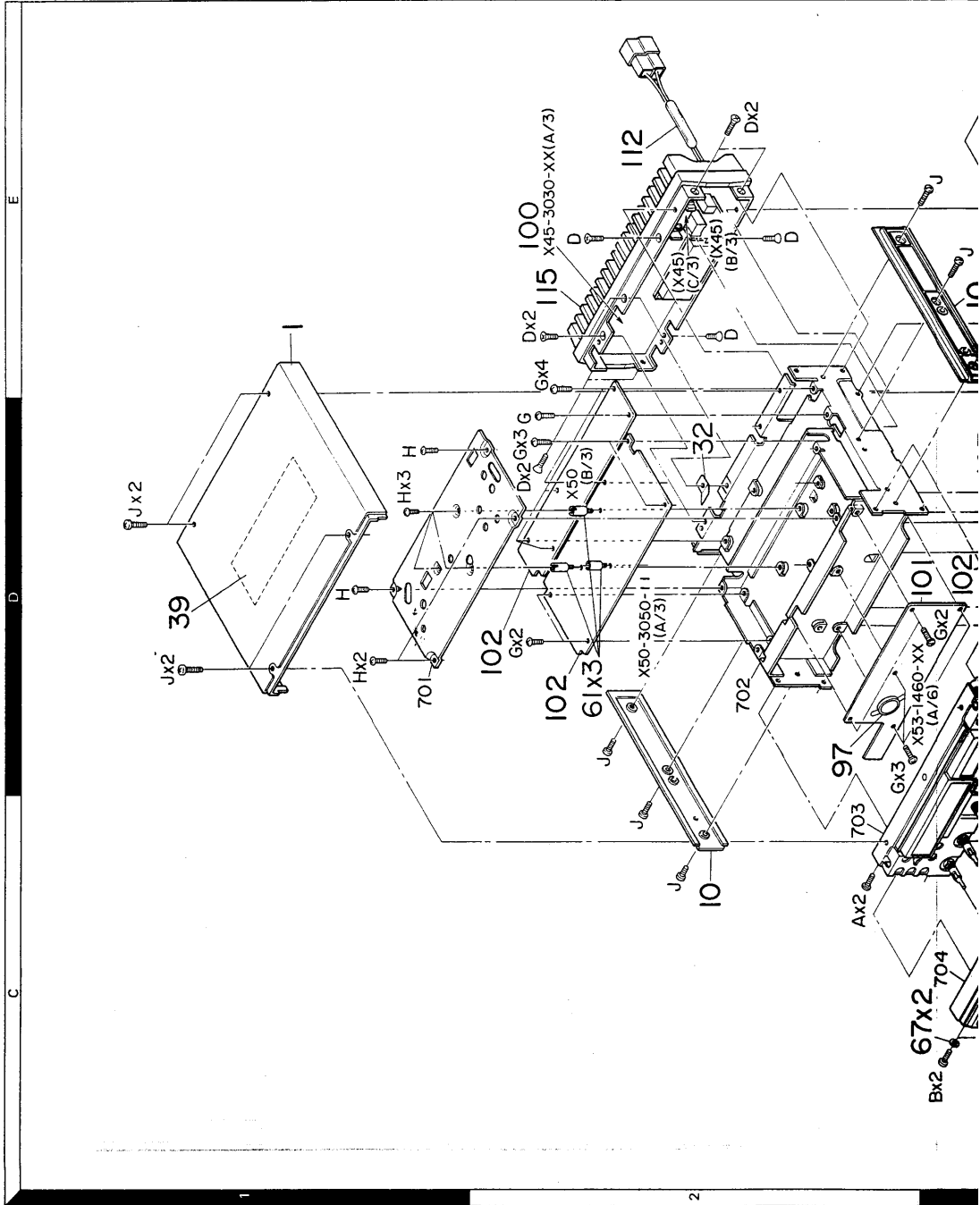





# A/E TR-851A/E

## ADJUSTMENT

with an AF digital multimeter in USB mode. In USB mode, the audio input voltages are necessary to that output almost reaches saturation (1kHz single tone). In FM mode, the audio input voltages are necessary to perform standard modulation (±3k dev.).

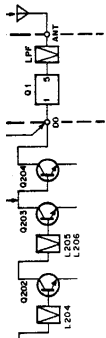

### REQUIRED TEST EQUIPMENT

1. **DC V.M**
  - 1) High input impedance
2. **RF VTVM (RF V.M)**
  - 1) Input impedance:  $1M\Omega$  min.,  $2pF$  max.
  - 2) Voltage range: F.S =  $10mV \sim 300V$
  - 3) Frequency range: Up to  $450MHz$
3. **Frequency Counter (f. counter)**
  - 1) Input sensitivity: Approx.  $50mV$
  - 2) Frequency range: Up to  $450MHz$
4. **DC Power Supply**
  - 1) Voltage:  $10V \sim 17V$ , variable
  - 2) Current:  $8A$  min.
5. **Power Meter**
  - 1) Measurement range Approx.:  $30W, 3W, 1W$
  - 2) Input impedance:  $50\Omega$
  - 3) Frequency range:  $450MHz$
6. **AF VTVM (AF V.M)**
  - 1) Input impedance:  $1M\Omega$  min.
  - 2) Voltage range: F.S =  $1mV \sim 30V$
  - 3) Frequency range:  $50Hz \sim 10kHz$
7. **AF Generator (AG)**
  - 1) Output frequency:  $100Hz \sim 10kHz$
  - 2) Output voltage:  $0.5mV \sim 1V$
8. **Linear Detector**
  - 1) Frequency range:  $450MHz$
9. **Field Strength Meter**
  - 1) Frequency range:  $450MHz$
10. **Directional Coupler**
11. **Oscilloscope**
  - 1) High sensitivity oscilloscope with horizontal input terminal
12. **SSG**
  - 1) Frequency range:  $144MHz$  and  $430MHz$  bands
  - 2) Modulation: AM and FM MOD.
  - 3) Output level:  $-20dB$  to  $100dB$
13. **Dummy Load**
  - 1)  $8\Omega$ ,  $5W$  (approx.)
14. **Noise Generator**
  - 1) Must generate ignition-like noise containing harmonics beyond  $450MHz$ .

### 15. Sweep Generator

- 1) Sweep range:  $1440MHz$  and  $430MHz$  bands

### 16. Tracking generator

### PREPARATION

- 1) Unless otherwise specified, knobs and switches should be set as follows **Table 12**.

POWER SW	ON	COM (K, M)	OFF
VOL VR	MIN	TONE (W, T)	OFF
SOL VR	MIN	LOW SW	OFF
RIT VR	CENTER	NB SW	OFF
RF GAIN VR	MAX	RIT SW	OFF
		DCL SW	OFF

Table 12

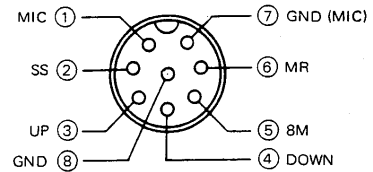

Fig. 12 MIC terminals (view from front panel side)

- 2) Use an insulated adjusting rod to adjust trimmers a coils.
- 3) To prevent damaging SSG, never set the stand I switch to SEND while adjusting the receiver section.
- 4) Be sure to turn the power switch OFF, before connecting the power cable to a power source.
- 5) SSG output levels are those at the time the output terminal is open.
- 6) Meter and display section should be set as follows **Fig. 13**.

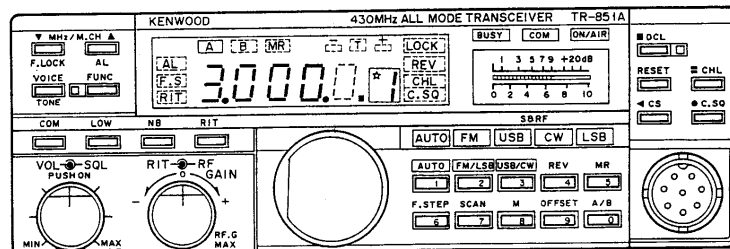

Fig. 13

## ADJUSTMENT

### COMMON ADJUSTMENT

Item	Condition	Measurement			Adjustment			Specification/Remarks
		Test equipment	Unit	Terminal	Unit	Part	Method	
1. Setting	1) Disconnect connectors J12 (TIF) and LT from the COMP. unit (FRONT). 2) Connect DC power supply to the DC connector on the panel (13.8V DC). Before connecting the power supply, turn the Power SW OFF.							
2. Reset	1) Turn the Power SW ON, holding the M SW down. 2) Release the M SW and select MODE : FM							[A] 3.000 Beeper sound. [AUTO] [FM] LED ON.
3. Voltage setting	1) RF GAIN VR : MAX	Digital multi-meter	RX	TP3 (3J)	RX	VR1 (3J)	4.0V	±0.1V
	2) Transmit signals (9T)			TP1 (4I)		VR13 (3H)	9.1V	±0.1V
	3) Return to receive mode.							

### PLL SYSTEM ADJUSTMENT

Item	Condition	Measurement			Adjustment			Specification/Remarks
		Test equipment	Unit	Terminal	Unit	Part	Method	
1. PLL (B)	1) Remove the seven screws from the shield plate of the COMP. unit (PLL). FREQ. : Any value (□.00) MODE : FM	Digital multi-meter	PLL	TP3 (3B)	PLL	L18 (4B)	6.0V	±0.1V
	2) MODE : LSB F.STEP : ON FREQ. : Any value (□.001.4) or (□.001.4.)							Check
	3) MODE : LSB FREQ. : Any value (□.001.5)	RF V.M		TP4 (4C)	PLL	L22 (4C)	MAX	0.1~0.25Vrms
2-1. 10.24MHz	1) MODE : LSB FREQ. : Any value	RF V.M	PLL	J1-SF (3E)	PLL	L4 (4E)	MAX	0.25~0.5V
2-2. 30.72MHz				J1-3SF (3E)		L5(3E) L6(3E) L7(3E)	Repeat for MAX.	0.2~0.5V
2-3. 92.16MHz				TP1 (3E)		L9,10 (3E) TC1(3D)	Repeat for MAX.	0.65~1.2V
2-4. 276.48 MHz				TP2 (3D)		L10,11 (3E)	MAX	0.25~0.65V
3. RIT BPF	1) MODE : LSB FREQ. : Any value	RF V.M	PLL	TP5 (4C)	PLL	L23 (4D) L24 (4D)	Repeat for MAX.	0.2~0.4V If the voltage is less than 0.2V, adjust as follows : 1. Turn the core of L24 up the case surface level. 2. Repeat the adjustment of L23 and L24 to obtain the MAX. deflection.
					RIT	L2 (4D)		

# TR-851A/E

## ADJUSTMENT

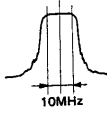
Item	Condition	Measurement			Adjustment			Specification/Remarks
		Test equipment	Unit	Terminal	Unit	Part	Method	
4. PLL (A)	1) MODE : LSB FREQ. : Any value	RF V.M	PLL	TP6 (4C)	PLL	L28 (4C) L30 (4C) L27 (4D)	Repeat for MAX. Turn the core of L28, L27 counterclockwise from the MAX position. Repeat the adjustment in order of L28, L30 and L27.	0.5~1.3V
	2) FREQ. : 0.000.0 F.STEP : ON	Digital multi-meter		TP7 (4C)	VCO	TC1 (3C)	2.0V	±0.1V
	3) FREQ. : 9.999.9						Check	6.2~7.2V
5. OSC X27	1) MODE : FM FREQ. : 5.000	f.counter	PLL	TP2 (3D)	OSC	TC1 (4E)	276.480MHz	±50Hz
				D4(3B) (Cathode)	RIT	TC1 (4D)	393.585MHz	±50Hz
6. RIT Zero beat	1) MODE : USB RIT VR : Centered RIT SW : ON	f.counter	PLL	D4(3B) (Cathode)	PLL	VR1 (3D)	Adjust of same freq. to the RIT OFF position.	±50Hz (393.585MHz)
	2) RIT VR : MIN ( - direction)							Less than -1.2kHz
	3) RIT VR : MAX ( + direction)							More than + 1.2kHz
7. Carrier	1) Remove the two screws from the CAR unit (Frame of the CAR unit).	RF V.M	RX	J8-CAR (2I)	CAR	L5(6I)	Turn the core of L5 counterclockwise from the peak point to set the value of 0.3V 0.3Vrms.	
	2) MODE : USB					TC3 (6I)	10.693.50MHz	±50Hz
	3) MODE : LSB					TC1 (6I)	10.696.50MHz	±50Hz
	4) MODE : CW Select CW and transmit.					TC2	10.694.30MHz	±50Hz
	5) Return to receive.							
8. T12 output	1) MODE : FM Transmit.	RF V.M	CAR	J7-T12 (6K)	CAR	L7(6J) L8(6J) L9(6J) L10 (6J) L11 (6J) L12 (6K) L13 (6K)	Repeat for MAX.	0.08~0.15V
9. HET helical	1) Connect the tracking gen. to the TP9 (coax. connector) from the COMP. unit (RX). FREQ. : 393.585MHz Output : 0dBm Then connect the spectrum analyzer to the LT terminal from the COMP. unit (RX).	Tracking Gen. Spectrum analyzer f.counter	PLL	LT (3B)	PLL	TC3 (3B) L41 (3C) L42 (3C) L43 (3B)	Repeat 2 or 3 times. to obtain the proper 10MHz bandwidth.	393.585MHz 
10. HET output	1) FREQ. : 5.000.0	RF V.M	PLL	D4(3B) (Cathode)	PLL	TC2 (3C) TC3 (3B)	Repeat for MAX.	0.35~0.75V



## ADJUSTMENT

### RECEIVER SYSTEM ADJUSTMENT

Item	Condition	Measurement			Adjustment			Specification/Remarks
		Test equipment	Unit	Terminal	Unit	Part	Method	
1. Helical	1) Disconnect coax. plug (LR) from the COMP. unit (FRONT). RF GAIN : MAX 2) Connect the sweep gen. to the ANT terminal (25dB) and the oscilloscope to the detector output. 3) After adjustment, reconnect LR.	Detector OSCILLO Sweep Gen. 	FRO-NT	TP301 (3K)	FRO-NT	TC301 (2K) TC302 (2K) L303 (3K) L304 (3K)	Adjust for the waveform perform shown on right. 	
2-1. Sensitivity ADJ. (FM)	1) Connect SSG to ANT terminal. SSG MOD : 1kHz SSG DEV : 3kHz Connect an 8Ω dummy load oscilloscope, and AF digital multimeter to the EXT. SP terminal. SQL VR : MIN RF GAIN VR : MAX MODE : FM FREQ. : 5.04 SSG output : 0dBμ (unmodulated)	S-meter			FRO-NT	TC303 (3K) L308 (3K) L309 (3K) L310 (4K) L311 (4K) L312 (4K)	Repeat for MAX.	12dB SINAD Less than -9dBμ <b>Note</b> Do not connect a microphone to the MIC jack.
	2) SSG output : -10dBμ (Modulated)	AF V.M			RX	L7(4J) L13 (3J)		
						L15 (4I)	MAX	
2-2. Sensitivity ADJ. (SSB)	1) MODE : CW RF GAIN VR : MIN 2) SSG output : -10dBμ (unmodulated) RF GAIN VR : MAX	OSCILLO	RX	TP4 (2J)	RX	TC1 (2I) L3(3K) L4(3J) L5(3I) L6(2I) L2(4K) L1(4K)	Repeat for MAX	Less than 5mVp-p MODE : CW (either USB or LSB) More than 10dB at SSG output -13dBμ.
3-1. S-meter (FM)	1) MODE : FM RF GAIN VR : MAX SSG output : 0dBμ (unmodulated)	S-meter			FRO-NT	L312 (4K)	MAX	
	2) SSG output : 0dBμ (modulated)				RX	L7(4J)		
	3) SSG output : 30dBμ (modulated)					VR5 (2J)	Set the RF scale to "2"	
	4) Repeat steps 2) and 3).					VR6 (2J)	Set the RF scale to a value greater than "10"	
3-2. S-meter (SSB)	1) MODE : CW SSG output : OFF (no signal)	S-meter			RX	VR3 (2J)	Set the S meter to mechanical 0 point.	
	2) RIT SW : ON SSG output : 0dBμ (unmodulated) Apply a signal and set the S-meter to MAX with the RIT VR.							

# TR-851A/E

## ADJUSTMENT

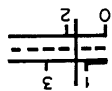
Item	Condition	Measurement			Adjustment			Specification/Remarks
		Test equipment	Unit	Terminal	Unit	Part	Method	
3-2. S-meter (SSB)	3) SSG output : $-3dB\mu$	S-meter			RX	L5(3I)	Turn the core of L5 counterclockwise to set the S meter to "1.5".	Center point between S scale's 1 and RF scale's 2 (upside down view) 
	4) SSG output : $30dB\mu$					VR4 (2J)	Set S meter to "+ 10".	
	5) Repeat steps 3) and 4).							
4. Noise blanker	1) MODE : CW SSG output : $10dB\mu$	DC V.M	RX	TP2 (4J)	RX	L10 (3J) L8(4J)	MIN	Turn the NB switch on and then off and check that the noise blanker operates.
	2) Connect the noise generator to the ANT terminal.							
5. FM Tight squelch	1) Connect the SSG to the ANT terminal. MODE : FM SQL VR : MAX SSG output : $-5dB\mu$ (no modulated)	OSCILLO			RX	VR14 (4I)	Turn the VR14 clockwise to the point at which squelch just close, then turn the VR14 counterclockwise to the point at which squelch just opens.	
6. SSB Squelch	1) Connect the SSG to the ANT terminal. SSG output : $-9dB\mu$ RIT SW : ON Turn the RIT VR until the AF V.M reads MAX. SQL VR : MAX	AF V.M OSCILLO			RX	VR2 (2I)	Turn the VR2 clockwise to the point at which squelch just opens.	

### TRANSMITTER SYSTEM ADJUSTMENT

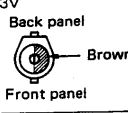
Item	Condition	Measurement			Adjustment			Specification/Remarks
		Test equipment	Unit	Terminal	Unit	Part	Method	
1. Helical	1) Connect the J201 (T12) connector from COMP. unit (DRIVE). 2) Connect the J7 (T12) from the CAR unit. 3) Disconnect the LT connector from COMP. unit (DRIVE). 4) Connect the tracking gen. to the TP201 and the spectrum analyzer to the D0 terminal from COMP. unit (DRIVE). Output : $-30dBm$ MODE : FM Transmit.	Tracking Gen. Spectrum analyzer	DRIVE	D0 (2D)	DRIVE	L204 (2B) L205 (2C) L206 (2C) TC201 (2C) TC202 (2D)	Repeat 2 or 3 times. Adjust for the waveform perform shown right, using TC201 and TC202 to adjust the max gain of 435 MHz and obtain the proper 10MHz bandwidth.	430MHz marker appears slightly above 440MHz marker. 
2. IF output	1) Disconnect J12 (TIF) from the COMP. unit (RX). MODE : FM COMP. unit (RX) TC2 : Centered Transmit.	RF V.M	RX	J12-TIF (3K)	RX	L21 (3K)	MAX	0.2~0.3V 
3. Carrier level	1) MODE : CW Transmit	RF V.M	RX	J12-TIF (3K)	RX	VR10 (3I)	0.25V	$\pm 0.01V$
4. FM FREQ.	1) MODE : FM Transmit	f.counter	RX	J12-TIF (3K)	RX	TC2 (3I)	10.695.0MHz	$\pm 50Hz$
	2) Return to the receive mode and reconnect J12.							

## ADJUSTMENT

Item	Condition	Measurement			Adjustment			Specification/Remarks
		Test equipment	Unit	Terminal	Unit	Part	Method	
5. Drive output	1) MODE : CW FREQ. : 5.00 Connect 0.6 to 1.0W power meter to the D0 terminal from the COMP. unit (DRIVE). Transmit.	Power meter	DRIVE	D0 (2D)	DRIVE	TC201 (2D) TC202 (2D)	Repeat for MAX	More than 0.25W
6. RF output	1) Connect the coax. cable to the D0 terminal from the COMP. unit (DRIVE). Power meter 50W COMP. unit (DRIVE) VR4 : MAX MODE : CW Transmit.	Power meter						35W or more.
								DRIVE
7. RF meter	1) MODE : CW Transmit	RF meter			FINAL	VR1 (2C)	Set to the RF scale reads "8".	
8. Protection	1) MODE : CW Transmit.	DC V.M	FINAL	TP1 (2K)	FINAL	VR2 (2B)	MIN	
	2) Disconnect the power meter from the ANT terminal and open the ANT terminal.	DC A.M (DC power supply galvanometer)				VR3 (2B)	4.5A	Less than 5.0A
9. Low power	1) LOW SW : ON Connect the power meter to the ANT terminal.	Power meter			DRIVE	VR3 (2E)	5W	
10. DEV.	1) MODE : FM LOW SW : OFF (HI) Apply a 1kHz, 28mV signal to the MIC terminal Linear detector  ● MS-57A/61A (Anrits) HPF : OFF LPF : 20kHz De-emphasis : OFF  2) MIC input : 2.8mV 3) MIC input : 28mV	Linear detector or modulation analyzer  ● 4101 (WAVETEK) FILTER : 25kHz/15kHz De-emphasis : OFF			RX	VR7 (4I)	4.6kHz	±100Hz
						VR12 (3H)	3.0kHz	±100Hz
								Ensure that the freq' is 4.6kHz±100Hz. If not, return to step 1).
11. TONE T,W	1) MIC input : OFF TONE SW : ON Connect the TP9 terminal in the CONT unit to the ground.	f.counter	CONT	TP9 (4K)	CONT	VR2 (4K)	Connect the f.counter to the linear detector output.	1750Hz±10Hz
12. Carrier point	1) MODE : USB COMP. unit (RX) VR11 : Centered Disconnect J12 (TIF) from COMP. unit (RX). Apply a 400Hz and a 2600Hz signals to the MIC terminal at the same time (using a two tone generator).	OSCILLO	RX	J12-TIF (3K)	CAR	TC3 (6I)		Signal should not contain any noise.
	2) If only one AG is available, Set the AG output to 10W RF output. AG : 1.5kHz Adjust AG output to obtain 10W.							Change AG freq' from 400 to 2600Hz, and adjust so that the same power is obtained at both frequencies (both of USB and LSB).

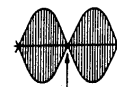
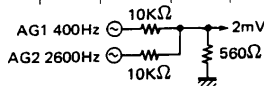
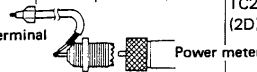







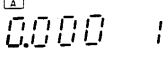
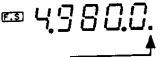
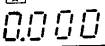
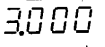
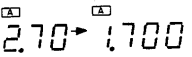
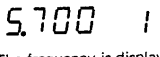

# TR-851A/E

## ADJUSTMENT

Item	Condition	Measurement			Adjustment			Specification/Remarks
		Test equipment	Unit	Terminal	Unit	Part	Method	
12. Carrier point	3) MODE : LSB	OSCILLO	RX	J12-TIF (3K)	CAR	TC1 (6I)	Make the same adjustment as in step 1).	
	4) Connect J12 (TIF) to the COMP. unit (RX).							
13. Carrier suppression	1) MODE : LSB LOW SW : ON COMP. unit (RX) VR11 : MIN	Spectrum analyzer			RX	VR8 (3I) VR9 (3I)	Repeat for until MIN	Less than -55dB <b>Note</b> If you perform the carrier point adjustment, you must also adjust the carrier suppression.
	2) MODE : USB							Less than -45dB
14. SSB MIC gain	1) LOW SW : OFF (HI) MODE : USB MIC input : 5.0mV/ 1kHz <b>K,M</b> 2.8mV/ 1kHz <b>T,W</b>	Power meter			RX	VR11 (4H)	13W	
15. Side tone	1) MODE : CW AF VR : Centered Connect a CW key (or its equivalent) to the KEY terminal. Connect an 8Ω dummy load, AF digital multimeter, and OSCILLO to the EXT. SP terminal.	AF V.M			DRIVE	VR6 (3D)	Press the key and confirm that signals are transmitted, then set 0.5V.	±0.1V
16. Break-in	1) MODE : CW COMP. unit (DRIVE) VR7 : Centered	ON AIR LED						Check that the ON AIR LED remains on for a brief period after the key is repressed.
17. BEEP	1) Select the squelch threshold point. MODE : Any mode AF VR : Centered M SW : ON Receive.	OSCILLO (connect to the audio output)			DRIVE	VR6 (3D)	0.6Vp-p	±0.1V

## ADJUSTMENT

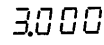
### Microprocessor operation check

Item	Condition	Operation check																			
1. Reset	1) Turn the POWER switch on, holding down the M switch.	<p></p> <p>Beeper sound.</p>																			
2. MODE function (AUTO, FM, USB, CW, LSB)	1) Press a mode switch (press FM).	Morse code F "-----" is output.																			
	2) Press FM again.	System enters LSB mode and Morse code L "-----" is output.																			
	3) Press USB.	System enters USB mode and Morse code U "-----" is output.																			
	4) Press USB again.	System enters CW mode and Morse code C "-----" is output.																			
3. Encoder /step	1) <table border="1" data-bbox="375 873 582 974"> <tr> <td>MODE</td> <td>FM</td> <td colspan="2">SSB/CW</td> </tr> <tr> <td>STEP</td> <td>OFF</td> <td>ON</td> <td>OFF</td> <td>ON</td> </tr> <tr> <td>K.M</td> <td>5K</td> <td>10K</td> <td>5K</td> <td>50Hz</td> </tr> <tr> <td>T.W</td> <td>12.5K</td> <td>5K</td> <td>5K</td> <td>50Hz</td> </tr> </table>	MODE	FM	SSB/CW		STEP	OFF	ON	OFF	ON	K.M	5K	10K	5K	50Hz	T.W	12.5K	5K	5K	50Hz	<p>50Hz step operation (STEP ON, CW, SSB MODE ON)</p> <p></p> <p>This segment goes on and off each time the encoder is clicked.</p>
MODE	FM	SSB/CW																			
STEP	OFF	ON	OFF	ON																	
K.M	5K	10K	5K	50Hz																	
T.W	12.5K	5K	5K	50Hz																	
4. A/B	1) Reset the micro-processor (as in step 1.).	<p></p>																			
	2) Press A/B key.	<p></p> <p>Beeper sound.</p>																			
5. ▼MHz/M.CH▲	1) MHz step operation. Press ▼ or ▲ key.	<p>A value on the MHz digit increment by one.</p> <p>Example</p> <p></p> <p>Note : In auto mode, mode changes from 0 FM → USB.</p>																			
	2) M CH operation Enter a frequency into memory.	<p></p> <p>The frequency is displayed.</p> <p>Press MR key.</p> <p>PRESS ▼ or ▲ key.</p> <p></p> <p>The number in this position changes.</p>																			
6. FUNC. function	1) F. LOCK operation Press FUNC key (orange).  Press MHC key.  Repeat the above operation.	<p>Beeper sound.</p> <p>Green LED on. </p> <p>LOCK at upper right of LCD goes on.</p> <p>Encoder or keyboard is not possible.</p> <p>Beeper sound.</p> <p>Green LED on. </p> <p>LOCK goes off.</p> <p>2) AL (alert) operation. Press FUNC key. Press /M.CH key.  Repeat above operation.</p> <p>Beeper sound.</p> <p>Green LED on. </p> <p>AL at upper left of LCD goes on.</p> <p>Beeper sound.</p> <p>Green LED on. </p> <p>AL goes off.</p>																			
7. RIT	1) Doesn't operate in the FM mode.	Warning output when RIT is turned on in FM mode.																			
	2) Select CW or SSB mode, and press RIT key.	Beeper sound. RIT at lower left of LCD goes on.																			
	3) Press RIT key again.	RIT goes off.																			
8. COM CH.	1) Press COM key.	<p>← A and B disappear.</p> <p></p> <p>COM above meter goes on. Frequency does not change even if encoder is turned.</p>																			
9. Memory entry	1) Set the frequency to be entered into memory and press the M key.	During the period the beeper is sounding, press a key to enter the frequency.																			
		9 and 0 indicate stop channels, so different frequency values can be set for reception and transmission.																			
10. Memory recall (read the freq' that was set in step 9.).	1) Press MR key.	Beeper sound. 																			
	2) Press ▼ MHz/M.CH▲ key.	Frequency set in step 9. is displayed. Note : Mode also changes.																			

# TR-851A/E

## TERMINAL FUNCTIONS

Connector No.	Terminal No.	Terminal Name	Terminal Function
<b>FINAL UNIT (X45-3030-XX)</b>			
J1	1	9T	TX + 9V
	2	RM	RF Meter
	3	PRO	Protection
	4	DB	Drive + B
	5	-6	-6V
	6	APC	Auto power control
-	-	RA	RX ANT
	-	E	GND
	-	IN	Drive power input
-	-	E	GND
	1	AP	Audio power
	2	K2	Key 2
-	1	SP	Speaker
	2	E	GND
	3	B	+ B
-	1	9T	TX + 9V
	2	ALC	ALC
	3	K1	Key 1
J2	1	EX2	Ext. Control 2
	2	EX1	Ext. Control 1
	3	E	GND
	4	EAL	Ext. ALC input
<b>CAR UNIT (X50-3040-00)</b>			
J1	1	E	GND
	2	SP	Speaker
J2	1	E	GND
	2	SP	Speaker
J3	1	SCB	SSB, CW + B
	2	CWT	CW TX + B
	3	LSB	LSB + B
J4	1	CAR	Carrier
	2	E	GND
J5	1	E	GND
	2	3SF	3rd standard freq' (30.72MHz)
J6	1	ALC	ALC
	2	ALC	ALC
	3	KL	Keying line
	4	9T	TX + 9V
	5	E	GND
	6	TIF	TX 1st IF (10.695MHz)
J7	1	T12	TX 2nd IF (41.415MHz)
	2	E	GND
	2	E	GND
<b>COMPOSITE UNIT (PLL, DRIVE, FRONT) (X50-3050-11)</b>			
J1	1	3SF	3rd standard freq' (30.72MHz)
	2	E	GND
	3	E	GND
	4	SF	Standard freq' (10.24MHz)
J2	1	R3	RIT volume 3
	2	R2	RIT volume 2
	3	R1	RIT volume 1
J3	1	5C	+ 5V
	2	E	GND
	3	EA	PLL A enable
	4	EB	PLL B enable
	5	CP	PLL clock
	6	DP	PLL data
	7	CB	Common + B
J201	1	T12	TX 2nd IF (41.415MHz)
	2	E	GND

Connector No.	Terminal No.	Terminal Name	Terminal Function	
J202	1	E	GND	
	2	AP	Audio power	
	3	CB	Common + B	
J203	1	BZ	Beep output	
	2	VO	Voice output	
	3	E	GND	
	4	A2	Audio volume 2	
	5	E	GND	
J204	1	CWB	CW + B	
	2	HL	Hi/Low switch	
	3	SS	Standby switch	
J205	1	AP	Audio power	
	2	K1	Key 1	
	3	K2	Key 2	
J206	1	KL	Keying line	
	2	AP	Audio power	
	3	-6	-6V	
	4	ALC	ALC	
	5	9T	TX + 9V	
	6	RM	RF meter	
	7	8C	+ 8V	
J207	1	ALC	ALC	
	2	9T	TX + 9V	
J208	1	DB	Drive + B	
	2	9T	TX + 9V	
	3	RM	RF meter	
	4	E	GND	
	5	PRO	Protection	
	6	APC	Auto power control	
	7	-6	-6V	
J301	1	3SF	3rd standard freq' (30.72MHz)	
	2	E	GND	
J302	1	E	GND	
	2	3SF	3rd standard freq' (30.72MHz)	
	3	E	GND	
J303	-	8R	RX + 8V	
	-	E	GND	
	-	RIF	RX 1F (10.695MHz)	
-	-	LR	RX local	
-	-	LT	TX local	
-	-	E	GND	
-	-	LT	TX local	
-	-	DO	Drive power output	
-	-	LR	RX local	
-	-	RA	RX ANT	
-	-	AGC	AGC	
<b>CONTROL UNIT (X53-1460-XX)</b>				
J1	1	PS0	} VS-1 Data	
	2	PS1		
	3	PS2		
	4	PS3		
	5	PS4		
	6	SR		
	7	BY		
	8	5C		+ 5V
	9	EB		PLL B Enable
	10	EA		PLL A Enable
	11	CP		PLL Clock
	12	DP		PLL Data

# ADJUSTMENT

TOP VIEW

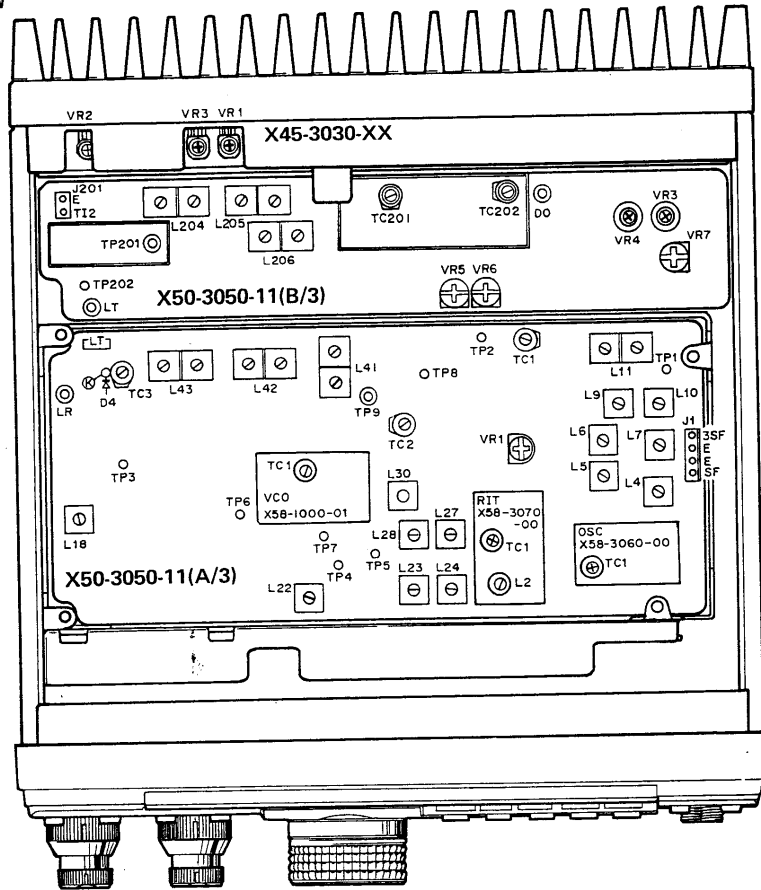

## FINAL UNIT (X45-3030-XX)

VR1 : RF METER  
 VR2 : PROTECTION (NULL)  
 VR3 : PROTECTION (ANT OPEN)

## COMPOSITE UNIT (PLL) (X50-3050-11) (A/3)

VR1 : RIT  
 L4 : 10.24MHz TUNING COIL  
 L5~7 : 30.72MHz TUNING COIL  
 L9,10 : 92.16MHz TUNING COIL  
 L11(TC1) : 276.48MHz TUNING COIL  
 L18 : LOOP B VCO COIL  
 L22 : 9.668~9.688MHz TUNING COIL  
 L23,24 : RIT BPF (91.597MHz) TUNING COIL  
 L27,28,30 : LOOP A TUNING COIL  
 L41~43 : HET HELICAL  
 TC1(L11) : 276.48MHz  
 TC2,3 : HET OUTPUT

## COMPOSITE UNIT (DRIVE) (X50-3050-11) (B/3)

VR3 : LOW POWER  
 VR4 : HI POWER (APC)  
 VR5 : BEEP LEVEL  
 VR6 : SIDE TONE LEVEL  
 VR7 : CW BREAK IN DELAY (MECHANICAL CENTER)  
 L204~206 : TRANSMIT HELICAL  
 TC201,202 : TRANSMIT HELICAL

## VCO (X58-1000-01)

TC1 : LOOP A VCO

## OSC (X58-3060-00)

TC1 : 276.480MHz

## RIT (X58-3070-00)

L2 : RIT BPF  
 TC1 : 393.585MHz





## TERMINAL FUNCTIONS

Connector No.	Terminal No.	Terminal Name	Terminal Function
J2	1	SQ	Squelch
	2	SQ1	Squelch Volume 1
	3	SQ2	Squelch Volume 2
	4	AL	Alert Mute
	5	ST	Standby
	6	E	GND
	7	CWB	CW + B
	8	CWB	CW + B
	9	SSB	SSB + B
	10	8C	+ 8V
	11	SCB	SSB, CW + B
J3	1	LSB	LSB + B
	2	CWB	CW + B
	3	USB	USB + B
	4	FMB	FM + B
	5	TL	TX LED
	6	BD	Busy LED
	7	E	GND
J4	1	SCB	SSB, CW + B
	2	LSB	LSB + B
	3	CWT	CW TX + B
	4	5C	+ 5V
	5	E	GND
J5	1	E	GND
	2	SCS	Slave Chip Select
	3	SRQ	Slave Request
	4	SCK	Slave Clock
	5	SDO	Slave Data Output
	6	RES	Reset
	7	SDI	Slave Data Input
	8	VDD	Backup voltage
	9	5C	+ 5V
	10	VFD	Voltage Fallen Detect
J6	1	SB	Switched + B (13.8V)
	2	SB	Switched + B (13.8V)
	3	SC	Scan Control
	4	ME	Mic Enable
	5	TO	Tone Output
	6	E	GND
	7	RD	RX Data
	8	E	GND
J8	1	E	GND
	2	TD	TX Data
	3	RD	RX Data
	4	E	GND
	5	5C	+ 5V
	6	MD	Modem Data
	7	ME	Mic Enable
	8	MC	Modem Clock
J9	1	SB	Switched + B (13.8V)
	2	B	+ B
	3	A1	Audio Volume 1
	4	E	GND
	5	E	GND
	6	A2	Audio Volume 2
	7	SQ1	Squelch Volume 1
	8	SQ2	Squelch Volume 2
J10	1	R3	RIT Volume 3
	2	R2	RIT Volume 2
	3	R1	RIT Volume 1
	4	E	GND
	5	RG2	RF Gain 2

Connector No.	Terminal No.	Terminal Name	Terminal Function
J12	1	E	GND
	2	MIC	MIC AF Input
	3	SS	Standby switch
	4	E	GND
	5	DW	Mic Down
	6	UP	Mic Up
	7	8M	Mic + 8V
	8	MR	Memory Recall
J201	1	E	GND
	2	SM	S-Meter
J202	1	LB	Lamp + B
	2	SM	S-Meter
	3	BZ	Beep Output
	4	SS	Standby Switch
	5	HL	Hi/Low Switch
	6	NBS	Noise Blanker Switch
J203	1	E	GND
	2	SCS	Slave Chip Select
	3	SRQ	Slave Request
	4	SCK	Slave Clock
	5	SDO	Slave Data Output
	6	RES	Reset
	7	SDI	Slave Data Input
	8	VDD	Backup Voltage
	9	5C	+ 5V
	10	VFD	Voltage Fallen Detect
J204	1	MR	Memory Recall
	2	8M	Mic + 8V
	3	UP	Mic Up
	4	DW	Mic Down
	5	E	GND
	6	SS	Standby Switch
	7	MIC	Mic AF Input
	8	E	GND
J205	1	8C	+ 8V
	2	MIC	Mic AF Input
	3	E	GND
<b>COMPOSITE UNIT (RX)(X60-1320-01)</b>			
J1	1	SF	Standard Freq' (10.24MHz)
	2	E	GND
	3	FSM	FM S-Meter
	4	SSQ	SSB Squelch
	5	E	GND
J2	1	RD	RX Data
	2	E	GND
	3	SQ	Squelch
J3	1	SC	Scan Control
	2	AL	Alert Mute
	3	8C	+ 8V
	4	8C	+ 8V
	5	A1	Audio Volume 1
	6	E	GND
J4	1	SCB	SSB, CW + B
	2	9T	TX + 9V
	3	9T	TX + 9V
	4	TO	Tone Output
	5	E	GND
	6	CWB	CW + B
	7	MIC	Mic AF Input
	8	E	GND
	9	ME	Mic Enable
	10	ST	Standby

# TR-851A/E

## TERMINAL FUNCTIONS/PACKING

Connector No.	Terminal No.	Terminal Name	Terminal Function
J5	1	CB	Common + B
	2	CB	Common + B
	3	-6	-6V
	4	-6	-6V
	5	SB	Switched + B (13.8V)
	6	E	GND
	7	B	+ B
J6	1	B	+ B
	2	E	GND
	3	SP	Speaker
J7	1	8C	+ 8V
	2	8C	+ 8V
	3	8C	+ 8V
	4	E	GND
	5	LB	Lamp + B
	6	E	GND
J8	1	CAR	Carrier
	2	E	GND

Connector No.	Terminal No.	Terminal Name	Terminal Function
J9	1	SSQ	SSB Squelch
	2	E	GND
J10	1	SM	S-Meter
	2	RM	RF Meter
	3	SCR	
	4	8C	+ 8V
	5	RG2	RF Gain 2
	6	FSM	FM S-Meter
J11	1	SSB	SSB + B
	2	-6	-6V
	3	NBS	Noise Blanker Switch
	4	9T	TX + 9V
	5	9T	TX + 9V
	6	ALC	ALC
J12	1	E	GND
	2	TIF	TX IF
J13	1	E	GND
	2	SP	Speaker

### PACKING

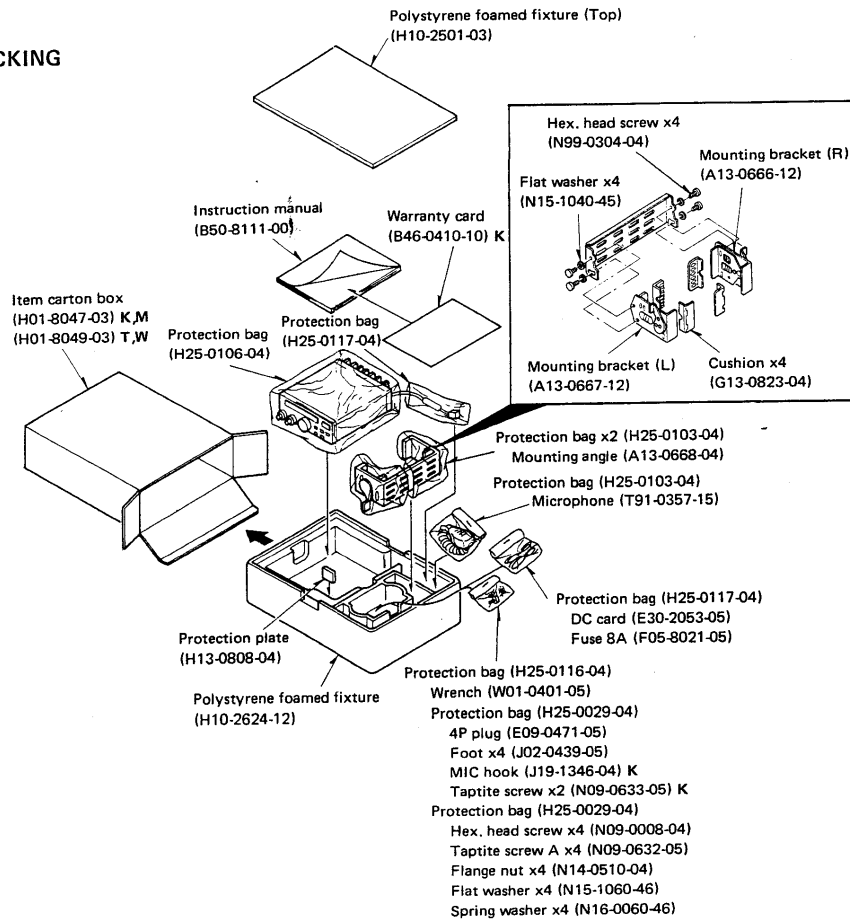

# PC BOARD VIEW TR-851A/E

LCD ASS'Y (W02-03XX-05) -0376 : K,M -0377 : T -0387 : W

Component side view

Foil side view

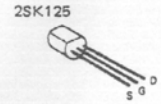
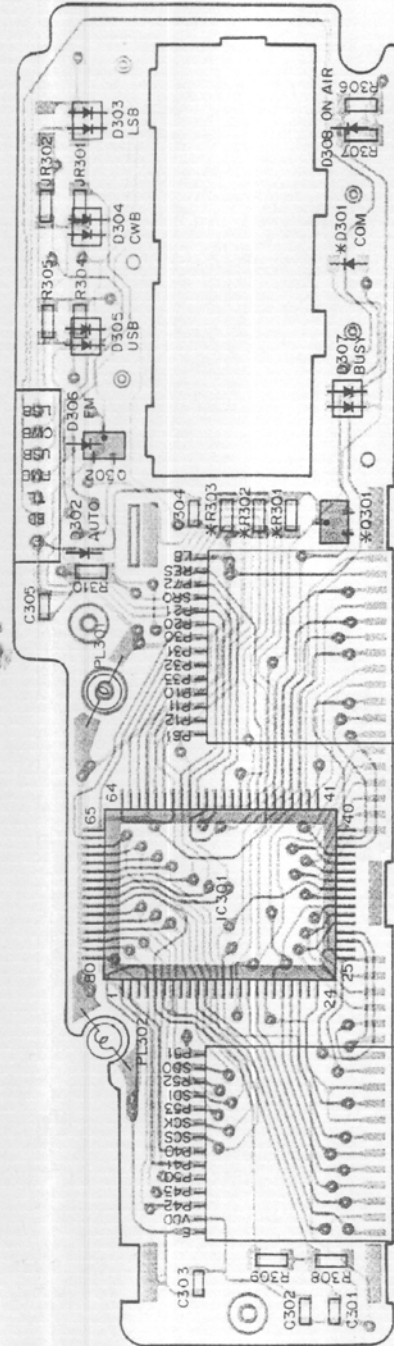
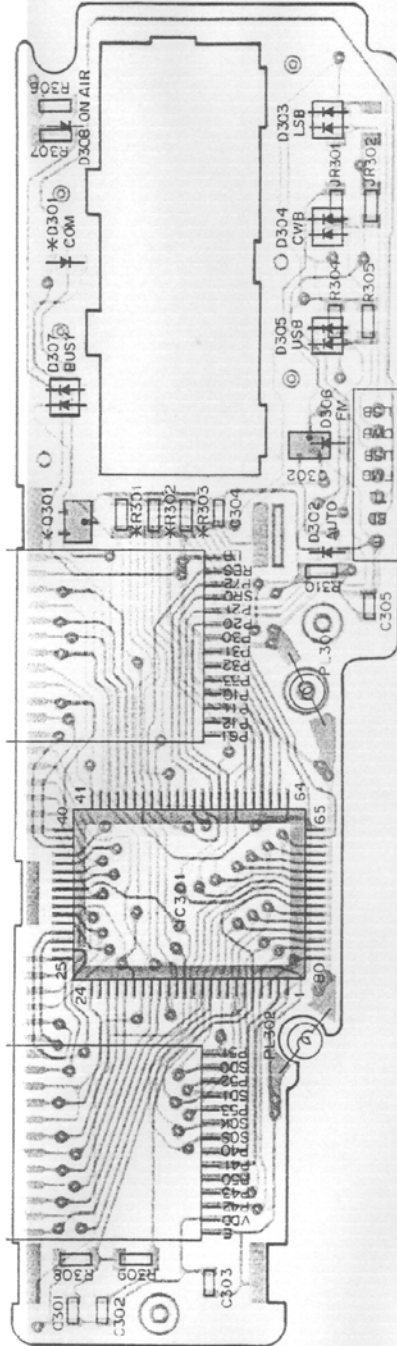

2SA1162 2SC2714  
2SC2712 2SC2715



DTC114EK  
IN OUT  
GND

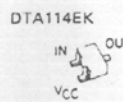

DTA114EK  
IN OUT  
VCC

	Q301	D301	R301-303
K,M	O	O	O
T,W	X	X	X

O : Used, X : Not used

Q301,302 : DTC114EK IC301 :  $\mu$ PD7514G-143-12  
C301,306 : B30-0844-05 D302,308 : B30-0842-05 D303-305,307 : B30-0843-05  
LCD : FSD-81688(I,K,M,T) FSD-81686(I,W)

VCO (X58-1000-01)  
Component side view

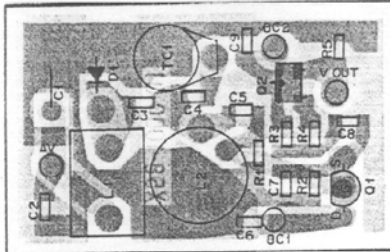

Q1 : 2SK125 Q2 : 2SC2714(Y)  
D1 : 1SV150

10.24MHz OSC (X58-3060-00)  
Component side view

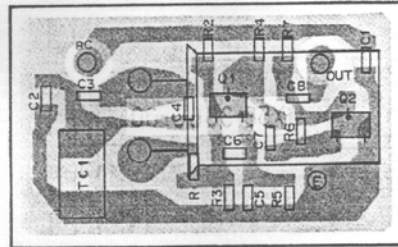

Q1 : 2SC2715(Y) Q2 : 2SC2712(Y)

RIT (X58-3070-00)  
Component side view

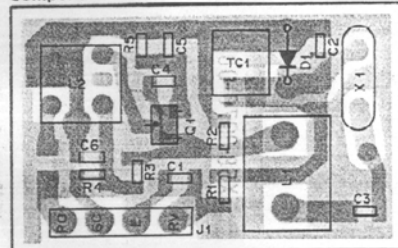

Q1 : 2SC2715(Y)  
D1 : 1SV153

-6V DC-DC (X59-1100-00)  
Component side view

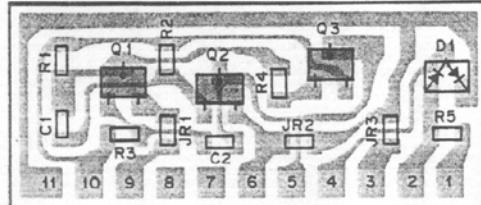

Q1,2 : 2SC2712(Y) Q3 : 2SA1162(Y)  
D1 : 1SS226

AF PRE AMP (X59-1110-00)  
Component side view

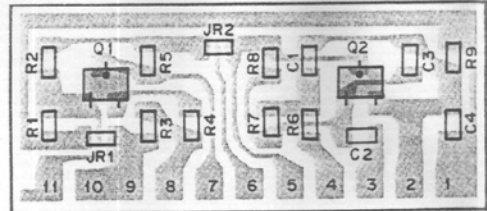

Q1,2 : 2SC2712(Y)

SQUELCH SWITCH (X59-1120-00)  
Component side view

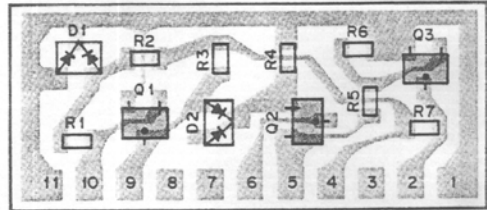

Q1-3 : 2SC2712(Y)  
D1,2 : 1SS184 or DAN202K

CW BREAK IN (X59-1130-00)  
Component side view

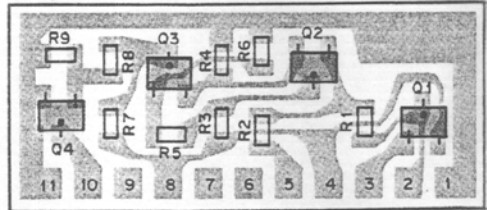

Q1 : DTA114EK Q2-4 : 2SC2712(Y)

MIC AMP (X59-3000-01)  
Component side view

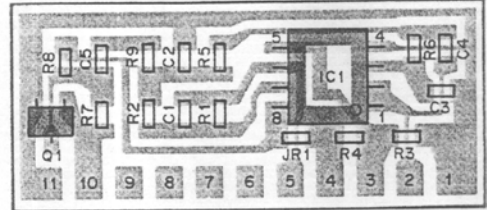

Q1 : 2SC2712(Y) IC1 : NJM4558M







# CIRCUIT DIAGRAM TR-851A/E

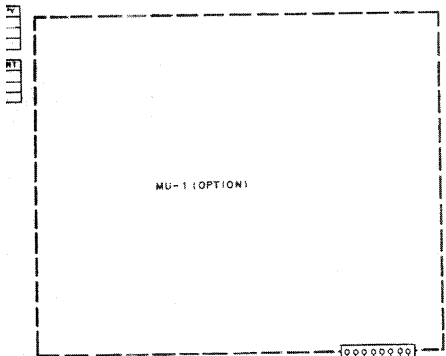

Q4,6,201-203,301,302  
DT114EK  
Q5  
DT114TK  
Q7,8  
DT114EK

- IC 1: 2PDT508HG-56\*22
- IC 2: DT5C124E
- IC 3: DT5A143E
- IC 4: 2PDT507SCT-22B
- IC 5: M2M2830L-DK
- IC 6: NE555P
- IC201: BU4584B
- IC202: HST523C
- IC301: 2PDT5140-145-12
- D1-9,11,14,16,18,22-24,207-211: 5S133
- D19,20,23,26,30,51,53: 1S518B BY DAP 202K
- D21,27,201-206: 1S5181 BY DAP 202K
- D29: 1S5106
- D32: 4M3276P
- D33: 4M4229P
- C301,306: MP-28A-001
- C302,308: MP-18K-001
- C303-305,307: MP-128G-001

ITEM	NO.	D1	D3	D4	D5	D6	D14	D30
11A	11A1	YES	YES	NO	NO	NO	NO	YES
11B	11B1	YES	NO	YES	YES	YES	NO	YES
11C	11C1	YES	NO	NO	NO	YES	NO	YES

B	C	H	JR2	JR3	J7
YES	NO	NO	YES	YES	NO
YES	NO	YES	YES	NO	NO

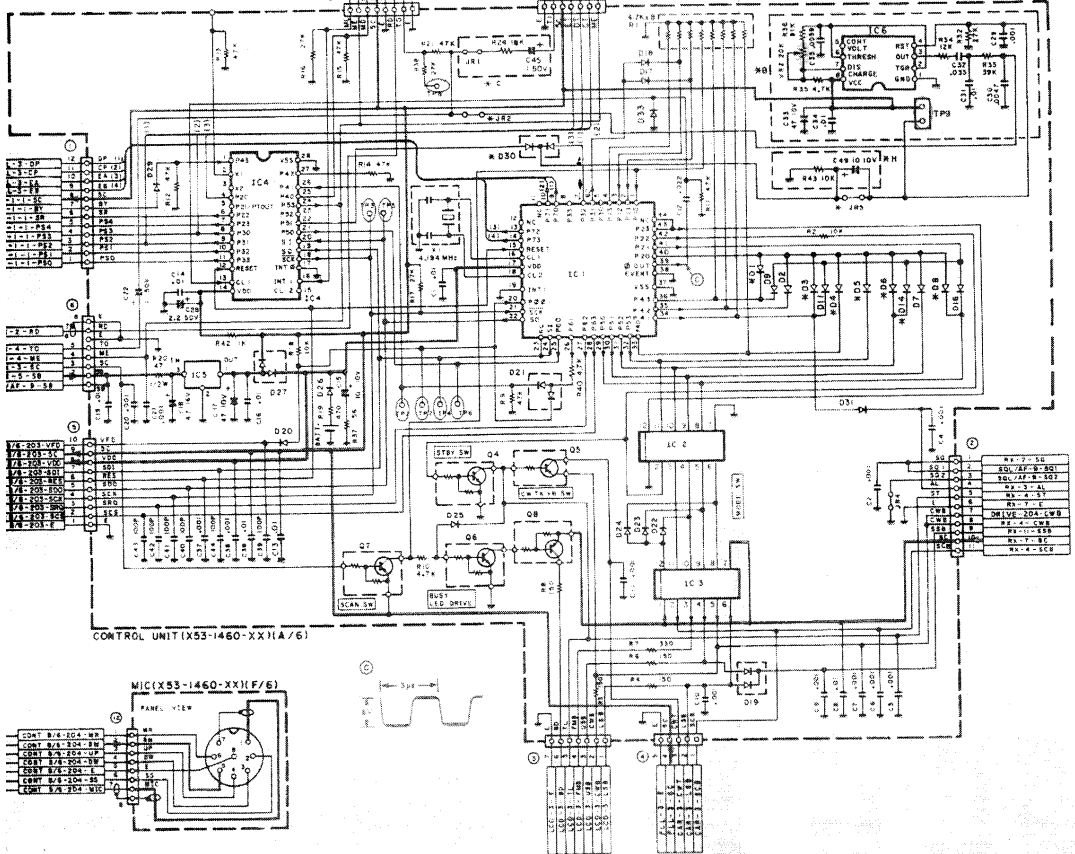

CONTROL UNIT (X53-1460-XX1A/6)

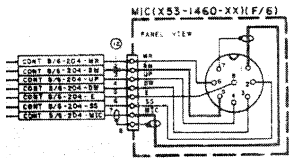

LCD ASSY (W02-03XX-05)

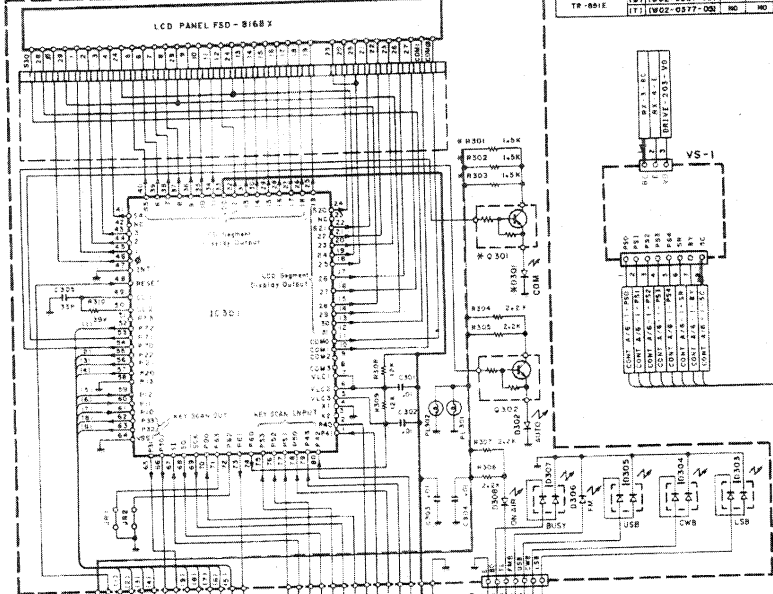

DESTINATION	NO	D301	D301	D301-D303	LCD ASSY
TR-B51A	(W02-0376-05)	YES	YES	YES	R168B
TR-B51E	(W1) (W02-0387-05)	NO	NO	NO	W168C
	(T1) (W02-0377-06)	NO	NO	NO	R168B

LCD SHIFT PRINT	
-	A
-	D-A,B,E
-	A

MU-1 OPTION

DESTINATION	NO	D1	D3	D4	D5	D6
TR-B51A	(T33-1460-13)	NO	YES	NO	NO	NO
TR-B51E	(W1) (X53-1460-02)	YES	NO	YES	YES	YES
	(T1) (X53-1460-03)	YES	NO	NO	NO	NO

S	C	B
NO	YES	NO
YES	NO	NO
YES	NO	YES

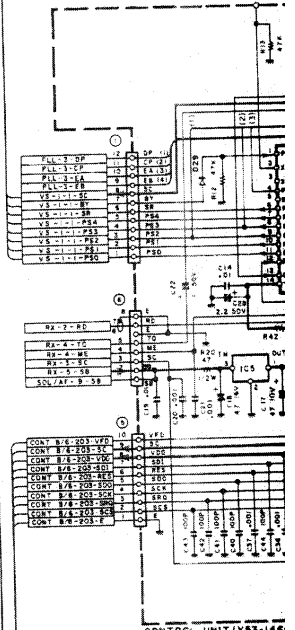
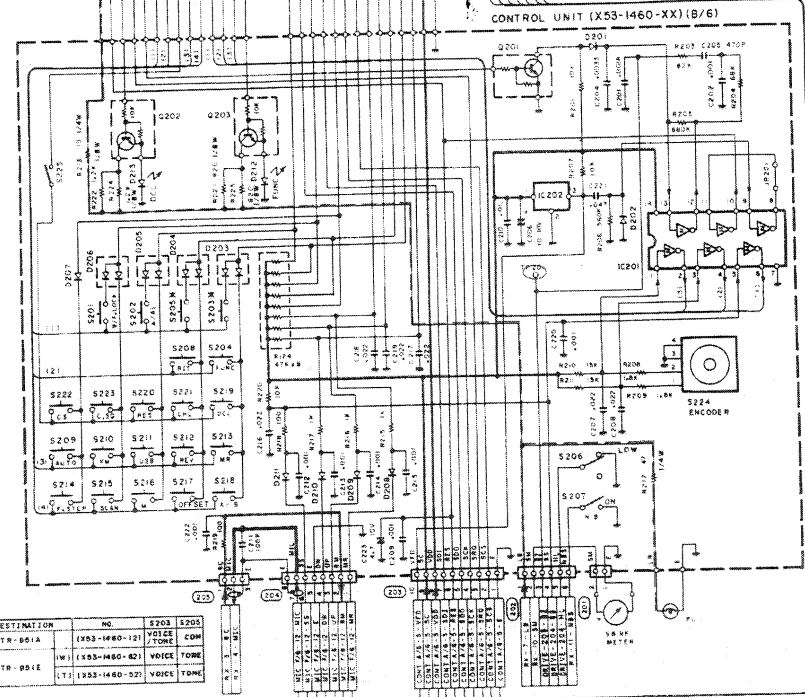

CONTROL UNIT (X53-1460-XX)

DESTINATION	NO	S203	S205
TR-B51A	(X53-1460-13)	VOICE	COM
	(W1) (X53-1460-02)	VOICE	VOICE
TR-B51E	(T1) (X53-1460-02)	VOICE	VOICE

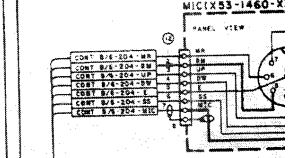

MIC (X53-1460-X)



E

CAR UNIT (X50-3040-00) Component side view

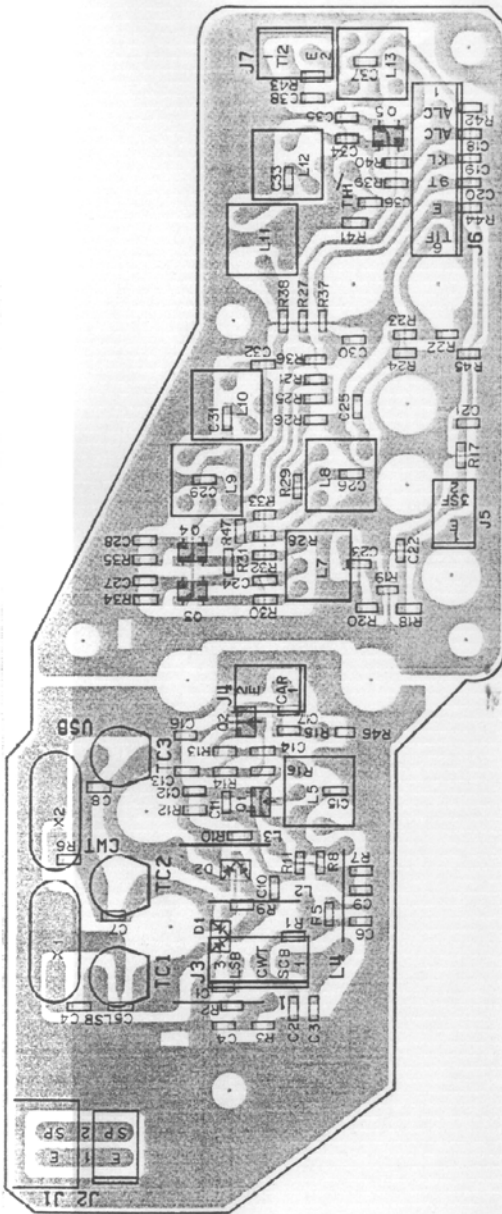

CAR UNIT (X50-3040-00) Foil side view

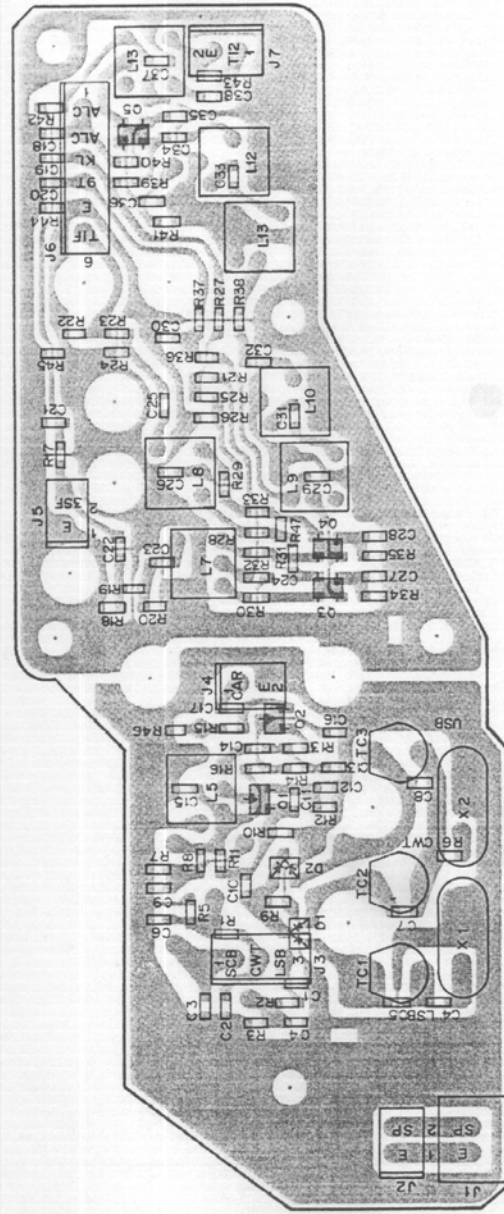

O1,2 : 2SC2714(Y) O3-5 : 3SK151(GR)  
 D1,2 : 1SS268

D1 : DSA3A1 D2,9 : 1SS181 D3 : M1407 D4 : M1308 D5-8 : 1SS101 D10 : MTZ6.2/A

# TR-851A/E PC BOARD VIEW

FINAL UNIT (X45-3030-XX) -11 : TR-851A -51 : TR-851E  
Component side view

FINAL UNIT (X45-3030-XX) -11 : TR-851A -51 : TR-851E  
Foil side view

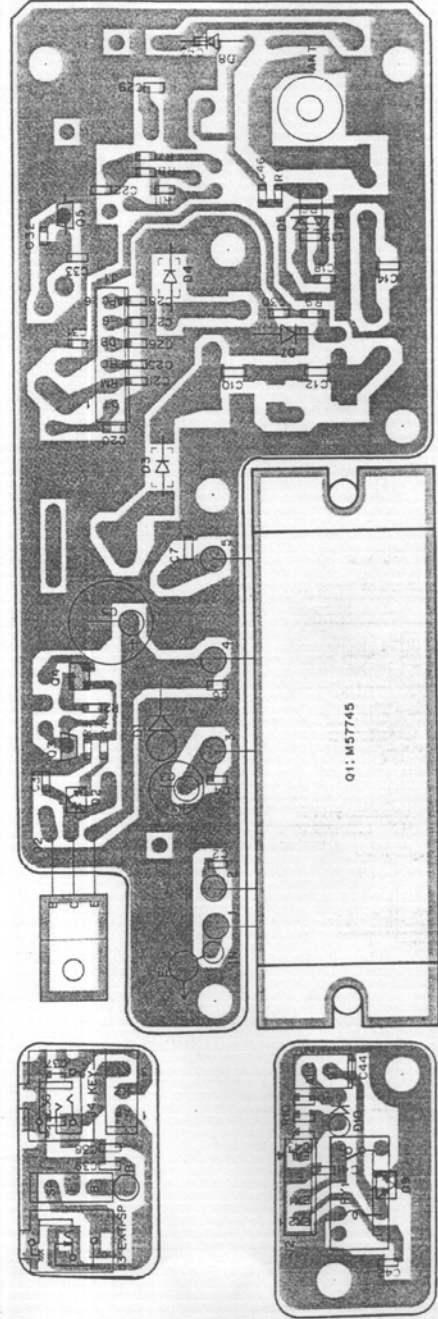
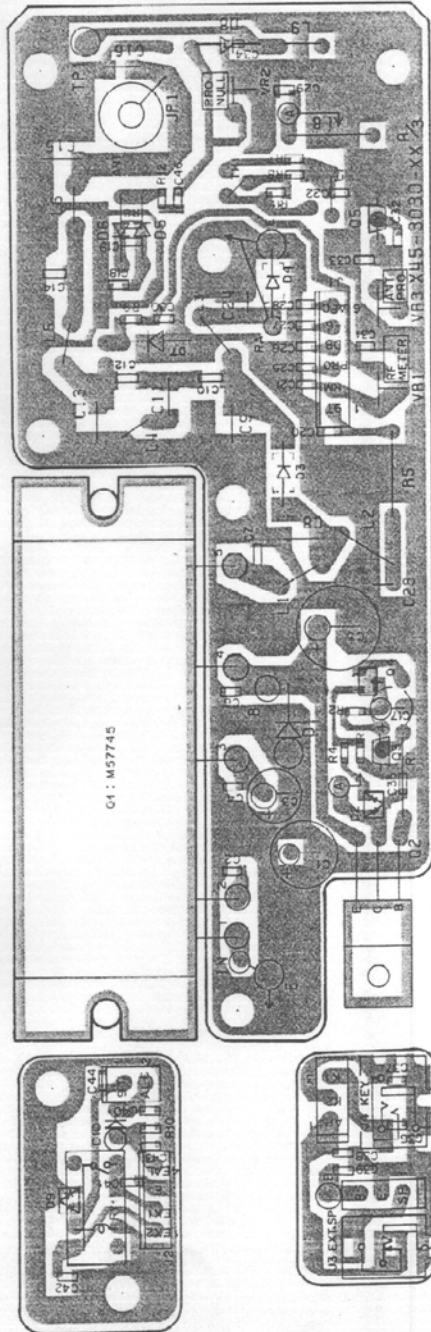

COMPOSITE UNIT (PLL,DRIVE,FRONT)(X50-3050-11) Component side view

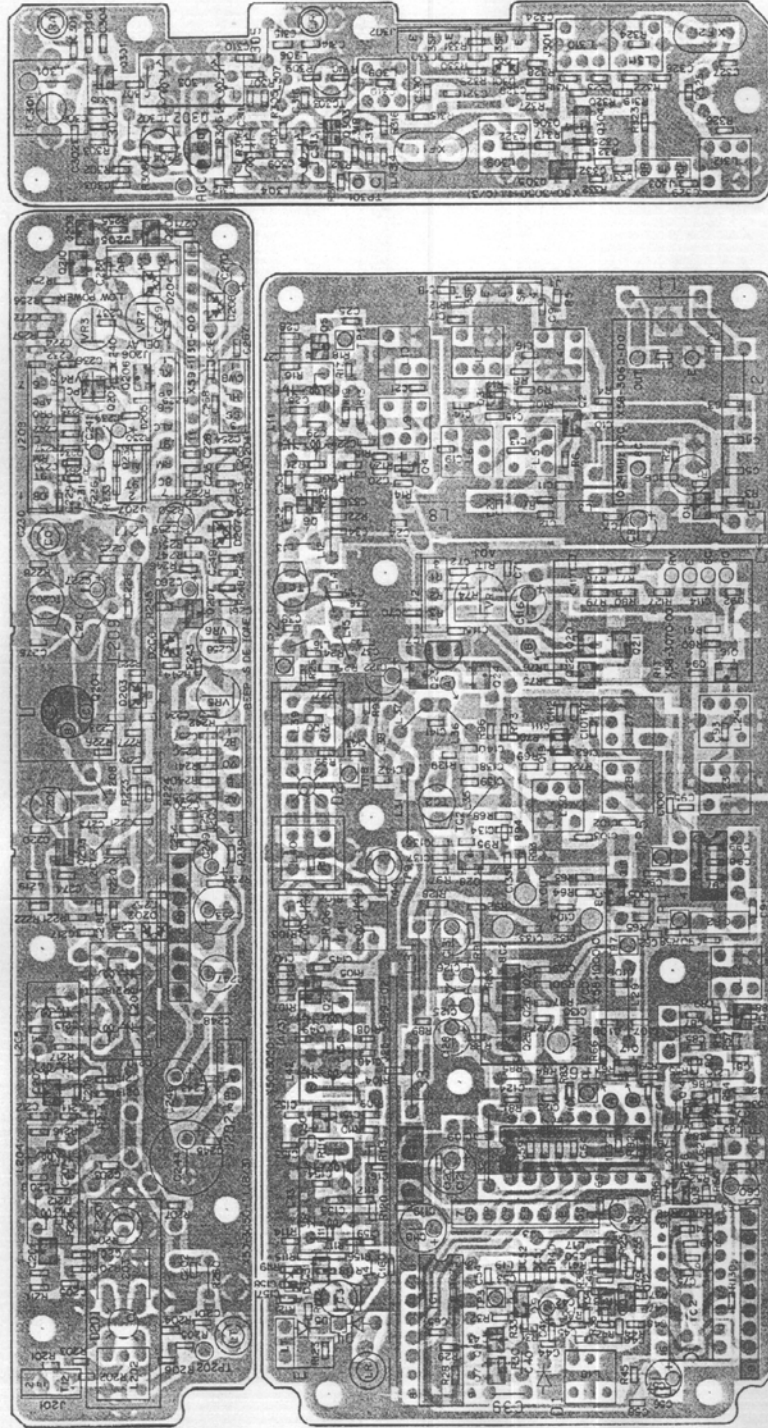

Q1-3 : 2SC2715(Y) Q4,10,11,14-18,28 : 2SC2714(Y) Q5,29,30,201,202 : 2SC3098 Q6,31,203 : 2SC3956 Q7-9,25-27 : 2SC3324(G,B) Q12,13,205,207 : 2SC2712(Y) Q19 : 3SK151(GR)  
 Q20,21,32,206 : DTC124EK Q22,24,208,210 : DTA143EK Q204 : 2SC2762 Q209 : 2SA2162(Y) Q301,303 : 3SK184(S) Q302 : 2SK125 Q304 : 3SK179(L)  
 Q305 : DTA114EK Q306 : DTC114EK  
 IC1.5 : TC9172P IC2 : TC74HC390P IC3 : TC5082P-G IC4 : SN16913P IC6 : L78N08 IC7 : N1M78L05A IC201 : MB3712  
 DI : 1SV153 D2,201 : ND487C1-3R D3,203,204,206-208 : 1SS184 D4,5 : 1SS277 D202 : 1SS226 D205 : 1N60PSPA D301 : 1SS268

# PC BOARD VIEW TR-851A/E

COMPOSITE UNIT (PLL,DRIVE,FRONT)(X60-3050-11) Foil side view

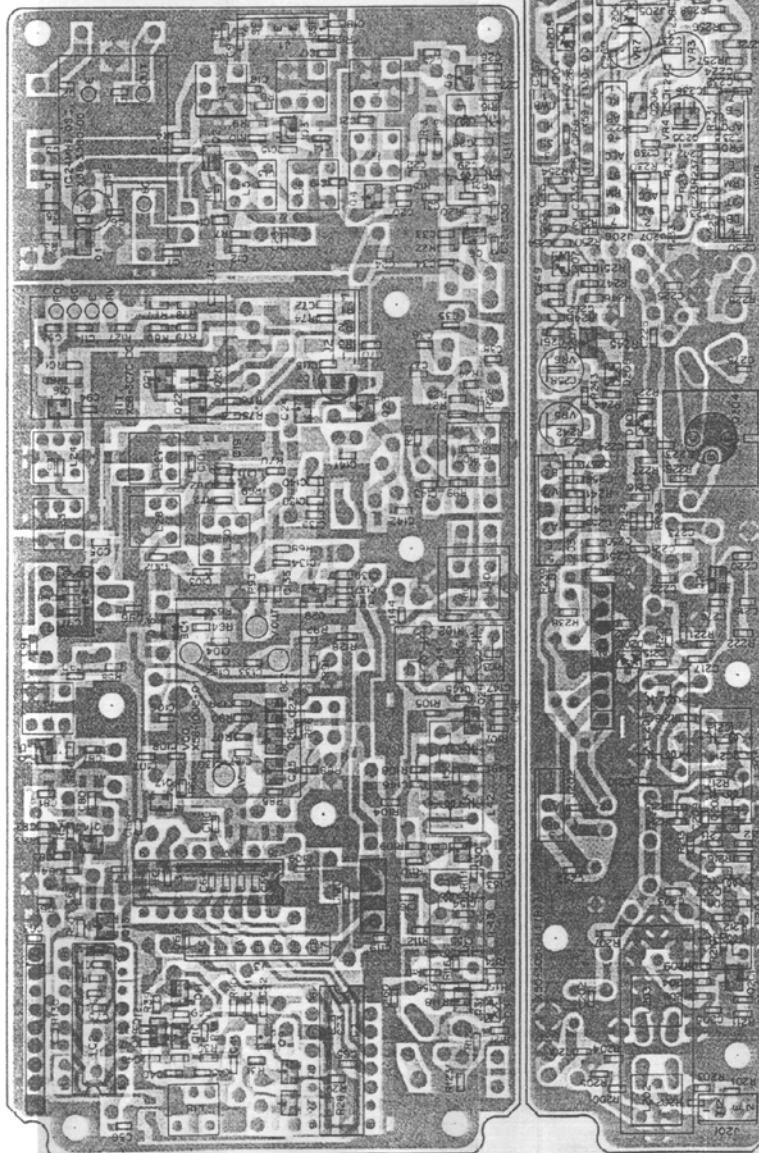
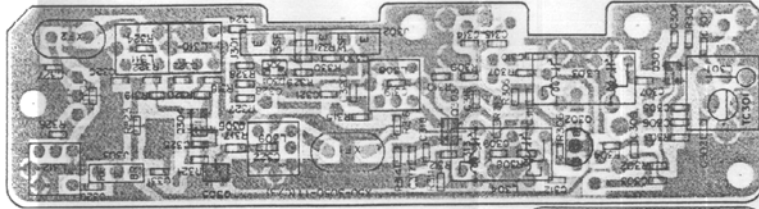

2SC2458

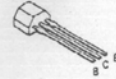

2SA1162 2SC3098  
2SC2712 2SC3324  
2SC2714 2SC3356  
2SC2715



2SA1037



2SC2762

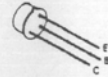

2SK125

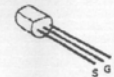

3SK151  
3SK179  
3SK184



DTC114EK



DTA114EK





COMPOSITE UNIT (RX)(X60-1320-01) Foil side view

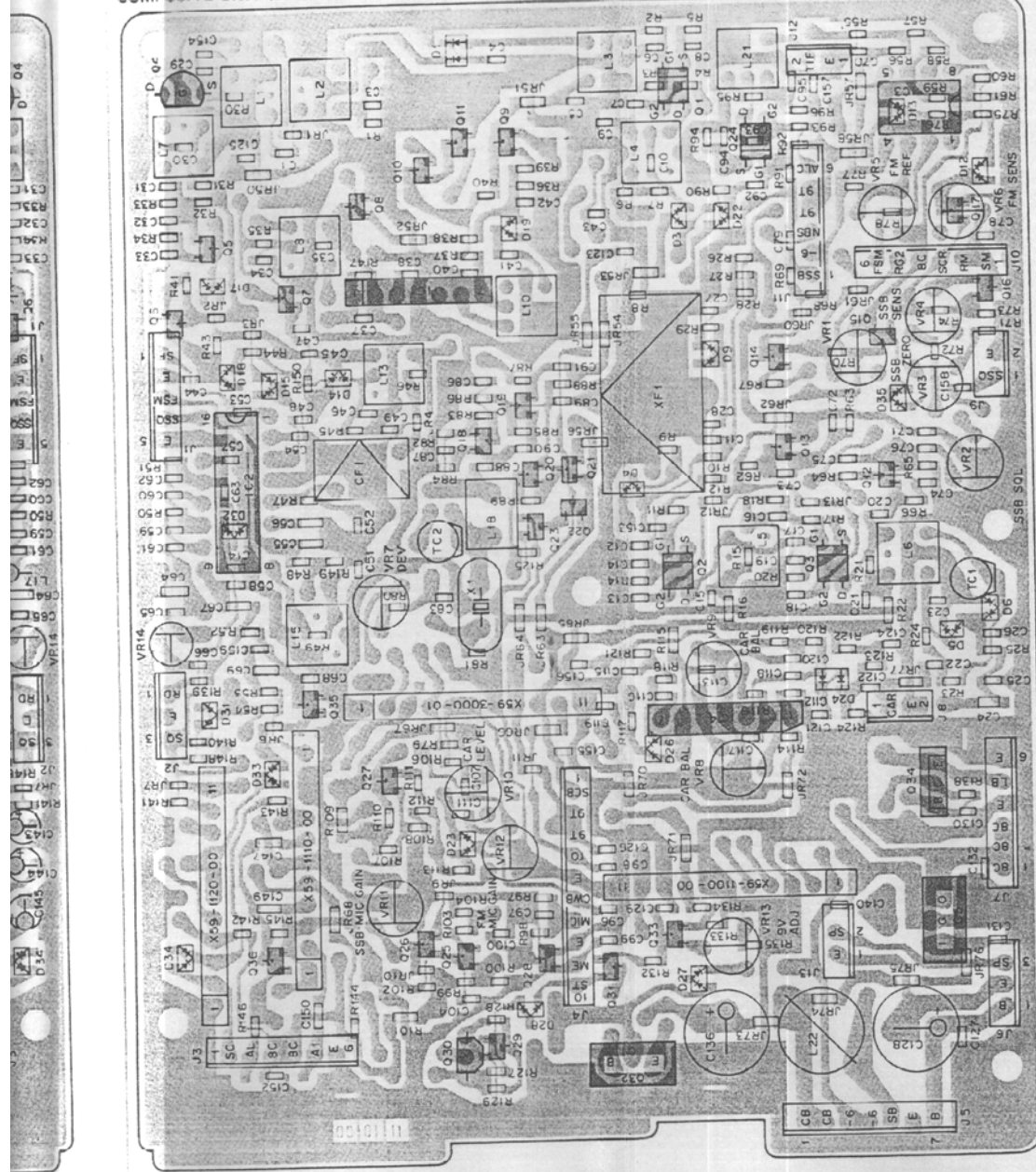

- Q1-3,24 : 3SK73(GR) Q4 : 2SK125 Q5,18,19 : 2SC2714(Y) Q6,8,9,12,13,20,31,36 : 2SC2712(Y) Q7,11,17,21,23,28,29,35 : DTC114EK Q10,22 : DTA114EK
- Q14,15 : 2SK208(O) Q16,33 : 2SA1162(Y) Q25-27 : 2SC3324(G,B) Q30 : 2SA1115(E) Q32 : 2SA1307(Y) Q34 : 2SC3419(Y)
- IC1 : TA7302P IC2 : TA7761P IC3 : NJM4558D or µPC4558C IC4 : AN612 IC5 : µPC78M08H
- D1,24 : 1SS272 D3,4,12-15,17,22,26,33,34 : 1SS184 D5,6,32 : HSM88AS D9,18,23,28,31,35 : 1SS181 D10,11 : 1SS106 D19,27 : 1SS226 D16,20 : 1SS133

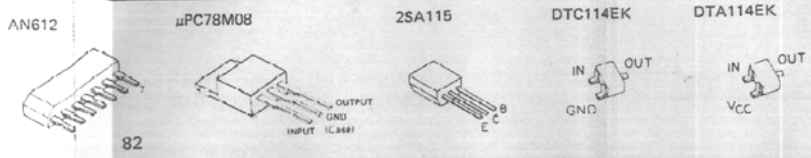





# SCHEMATIC DI

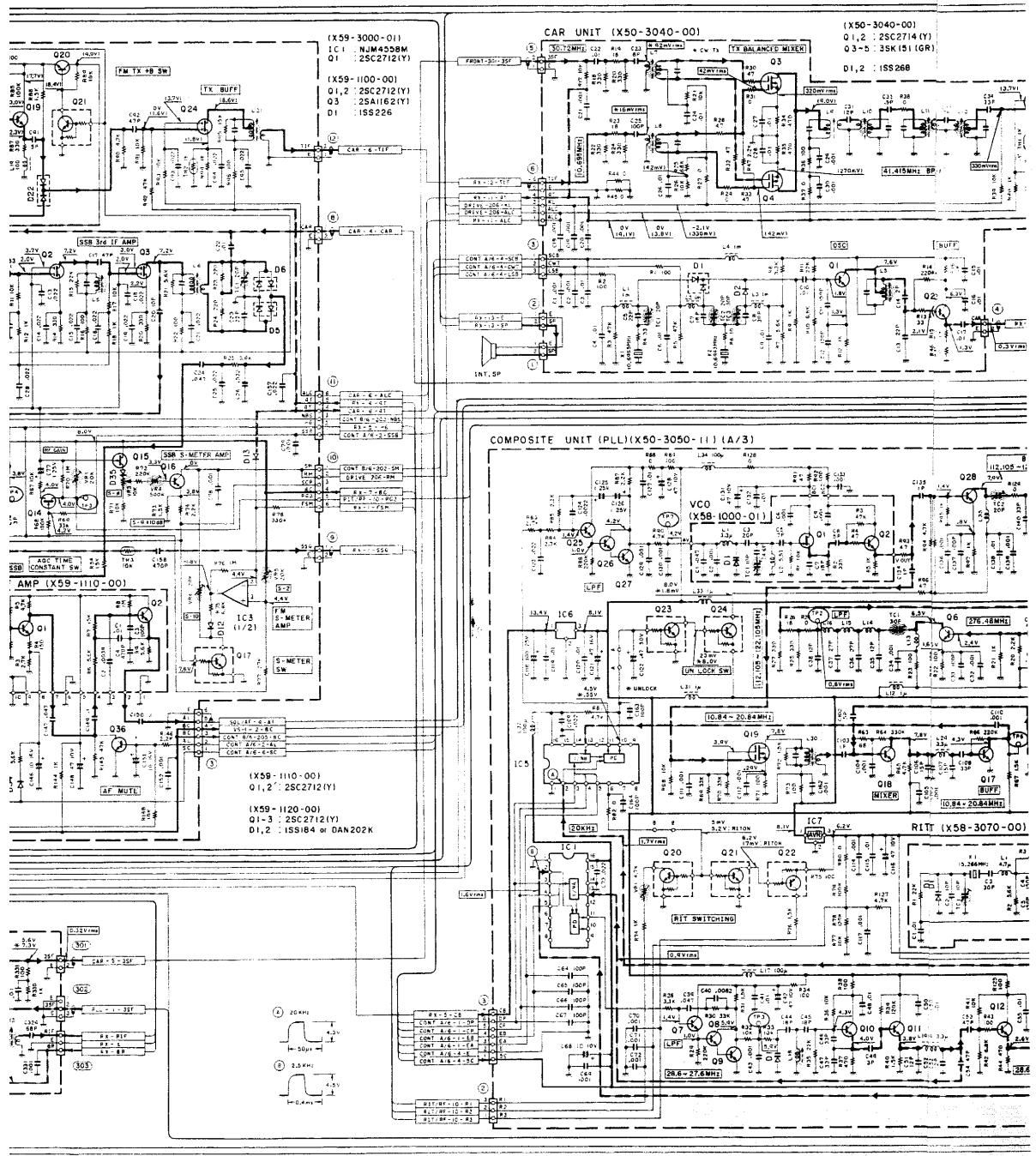



# MATIC DIAGRAM

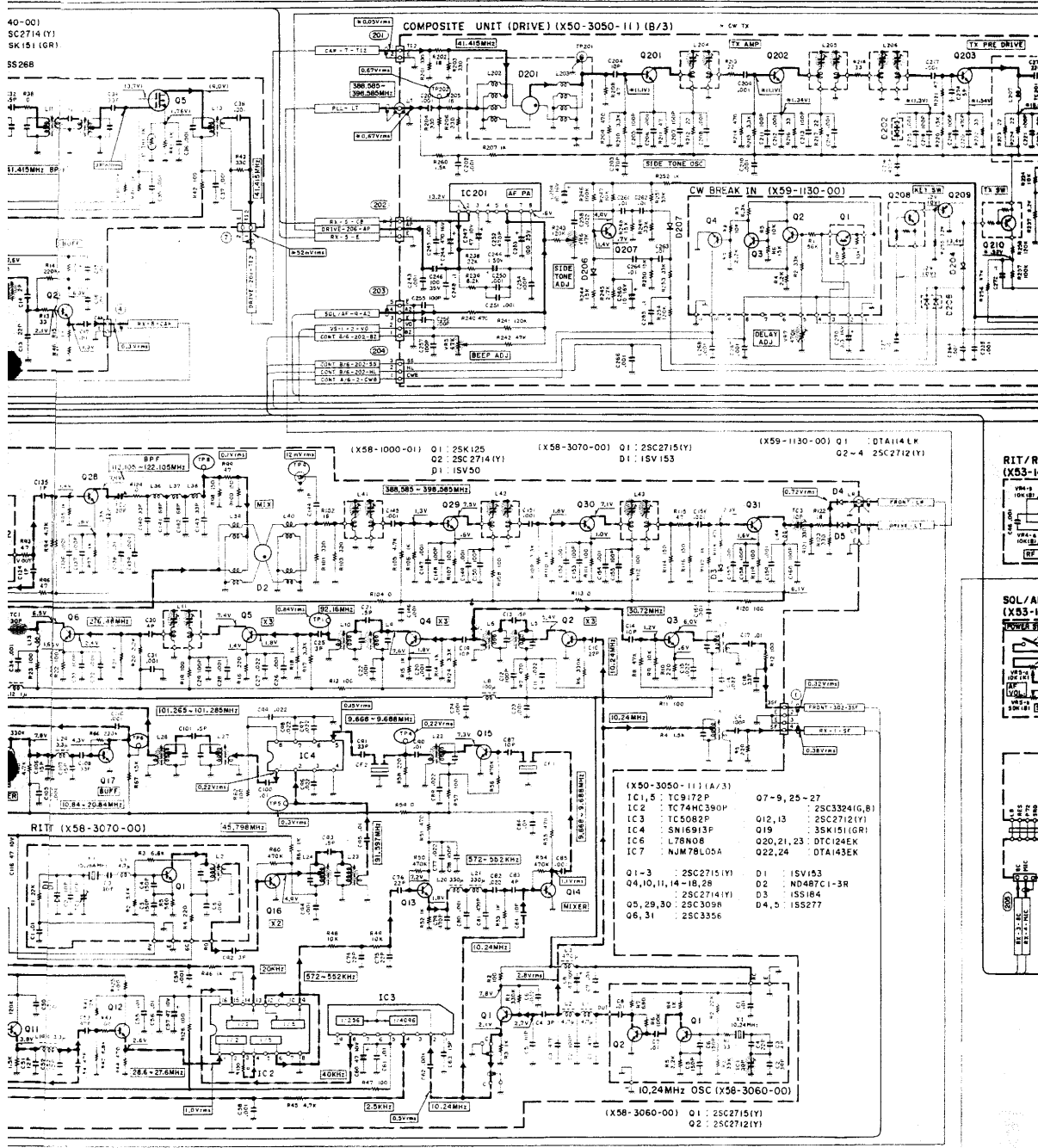

# TR-851A/E

Voltage measurement conditions  $f=435.00\text{MHz}$ , RX no signal, ( ): TX.

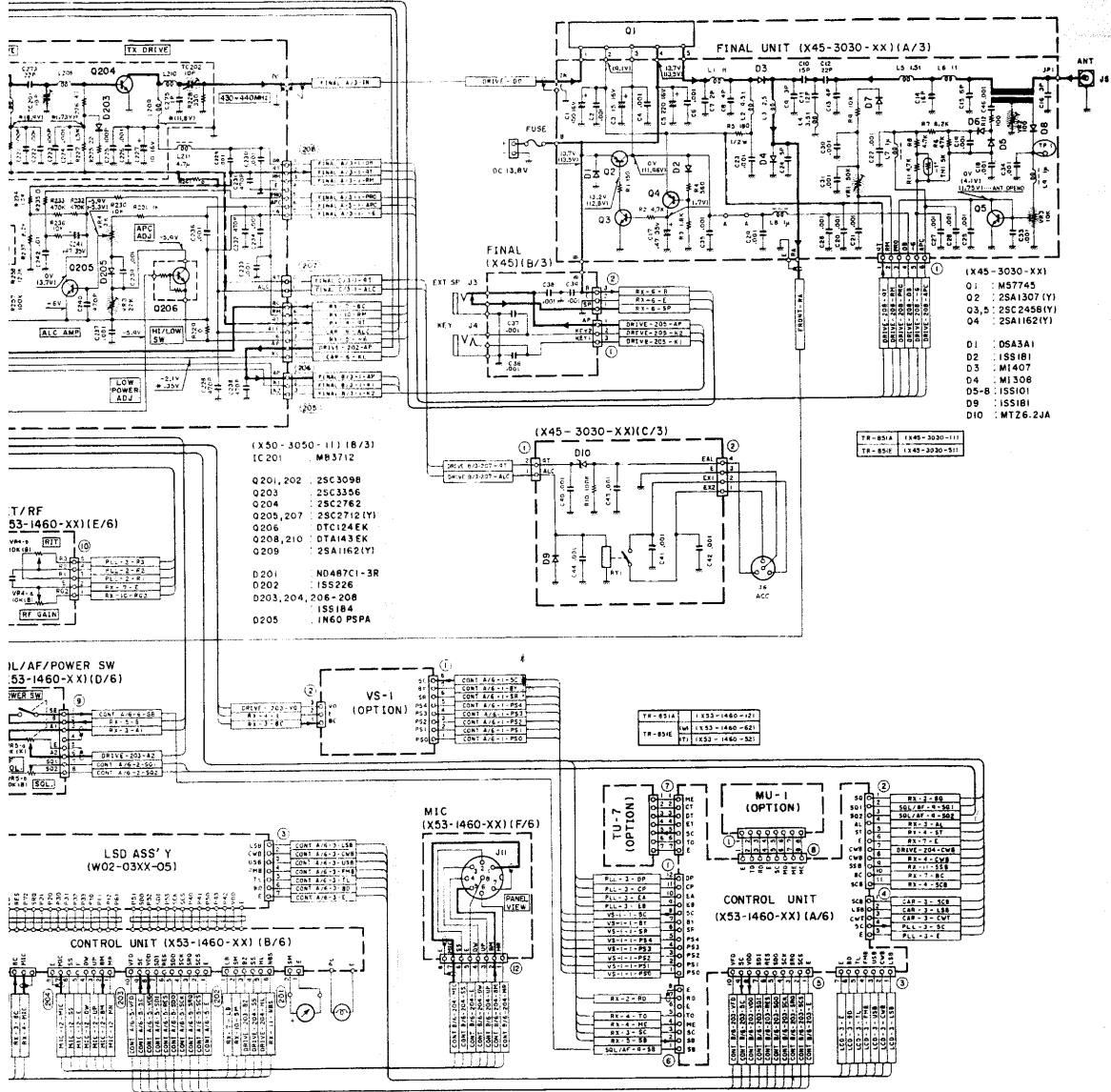

TR-851A/E (K,M,T,W)(1/2)

# E TR-851A/E

## MU-1 (MODEM UNIT)

MU-1 SCHEMATIC DIAGRAM

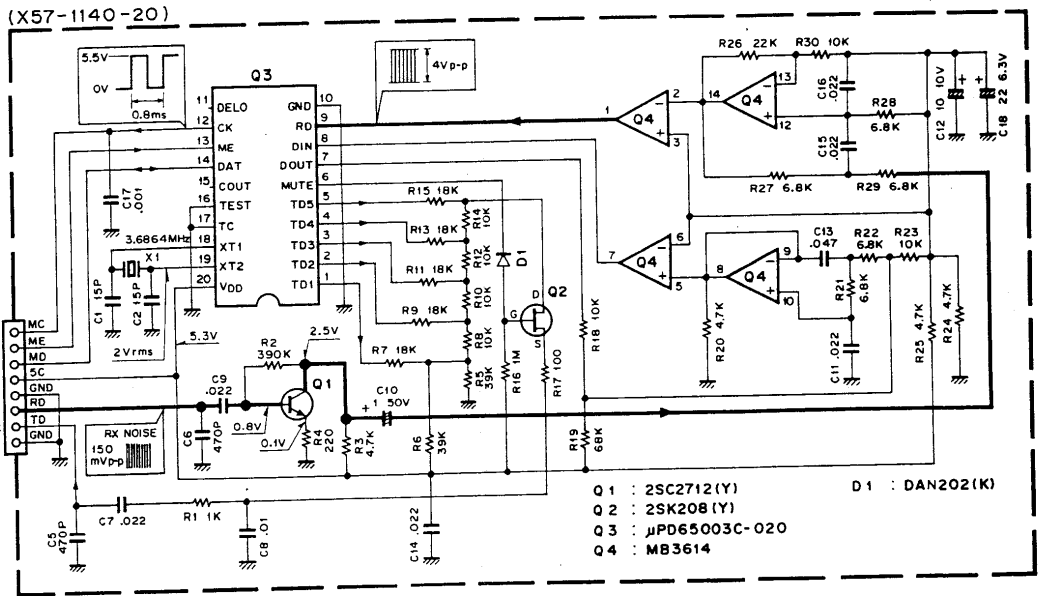

● Modulation output (TD terminal output on MODEM unit)

Condition		TD terminal output	
ME	MD	Frequency (Hz)	Output voltage (V)
5V	5V	1,200	1.3 ± 0.15
5V	0V	1,800	1.1 ± 0.15

● Demodulation output

Operation condition (RD terminal) : 40mV±3dB  
 (Confirm DAT terminal voltage by receiving a 60dBμ signal from SSG)

SSG MOD. frequency	DAT terminal voltage
1,200Hz	5V
1,800Hz	0V

No. 11, 12,14, 30, 1,13,15, 24,25, 2,27-29

## MU-1 (MODEM UNIT)

MU-1 OUTSIDE VIEW

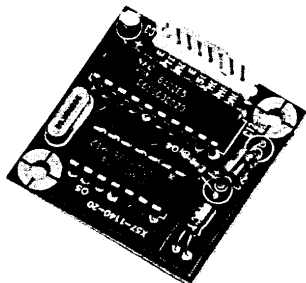

MU-1 PC BOARD VIEW  
(X57-1140-20) Component side view

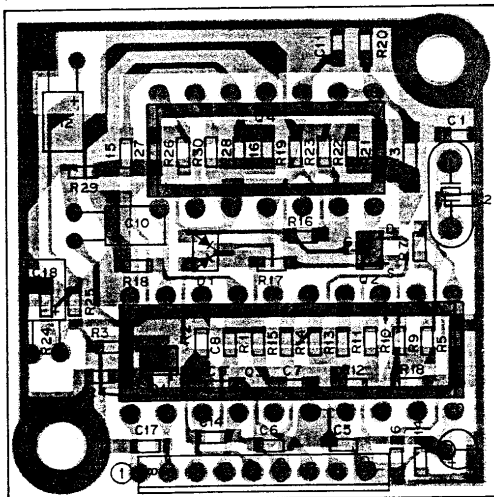

MU-1 PARTS LIST

Part No.	Re. marks	Description	Q'Ty	Ref. No.
<b>MU-1 (GENERAL)</b>				
B50-8046-10	N	Instruction manual	1	
G13-0826-04		Cushion	1	
H01-4680-03	N	Carton (Inside)	1	
H25-0029-04		Protective bag	2	
J32-0791-04		Hex. head boss	1	
N35-2604-41		Binding screw	2	
X57-1140-20	N	MODEM unit	1	
<b>MODEM UNIT (X57-1140-20)</b>				
CC73FCH1H150J		Chip cap. 15P	2	C1,2
CE04CW0J220M		Electro 22μ 6.3V	1	C18
CE04CW1A100M		Electro 10μ 10V	2	C3,12
CE04CW1H010M		Electro 1μ 50V	1	C10
CK73EB1E473K		Chip cap. 0.047μ	1	C13
CK73FB1H102K		Chip cap. 0.001μ	1	C17
CK73FB1H103K		Chip cap. 0.01μ	1	C8
CK73FB1H223K		Chip cap. 0.022μ	7	C4,7,9,11,14-16
CK73FB1H471K		Chip cap. 470P	2	C5,6
E40-5022-05		Mini-connector 8P	1	
L77-1295-05	N	X'tal oscillator 3.6864MHz	1	X1
RK73FB2A101J		Chip res. 100Ω	1	R17
RK73FB2A102J		Chip res. 1kΩ	1	R1
RK73FB2A103J		Chip res. 10kΩ	7	R8,10,12,14,18,23,30
RK73FB2A105J		Chip res. 1MΩ	1	R16
RK73FB2A183J		Chip res. 18kΩ	5	R7,9,11,13,15
RK73FB2A221J		Chip res. 220Ω	1	R4
RK73FB2A223J		Chip res. 22kΩ	1	R26
RK73FB2A393J		Chip res. 39kΩ	2	R5,6
RK73FB2A394J		Chip res. 390kΩ	1	R2
RK73FB2A472J		Chip res. 4.7kΩ	4	R3,20,24,25
RK73FB2A682J		Chip res. 6.8kΩ	5	R21,22,27-29
RK73FB2A683J		Chip res. 68kΩ	1	R19
2SC2712(Y)		Chip TR	1	Q1
2SK208(Y)		Chip FET	1	Q2
μPD65003C-020		IC	1	Q3
MB3614		IC	1	Q4
DAN202(K)		Chip diode	1	D1

MU-1 BLOCK DIAGRAM

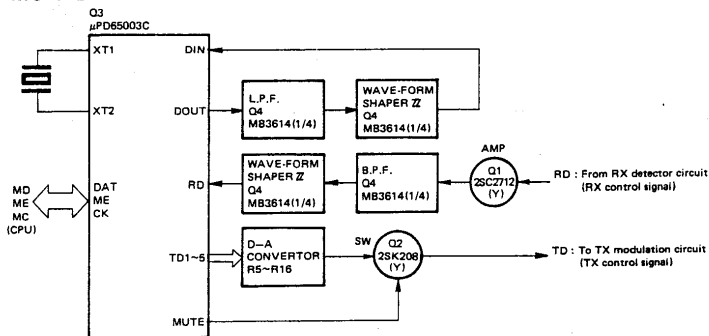

# TR-851A/E

## TU-7 (TONE UNIT)

### TU-7 OUTSIDE VIEW

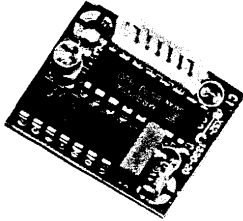

### TU-7 INSTALLATION AND TONE FREQUENCY SETTING PROCEDURE

Available CTSS tone frequencies

Hz	Hz	Hz
67.0	114.8	192.8
71.9	118.8	203.5
74.4	123.0	210.7
77.0	127.3	218.1
79.7	131.8	225.7
82.5	136.5	233.6
85.4	141.3	241.8
88.5	146.2	250.3
91.5	151.4	
94.8	156.7	
97.4	162.2	
100.0	167.9	
103.5	173.8	
107.2	179.9	
110.9	186.2	

Refer to the instruction manual provided with the transceiver.

### TU-7 PARTS LIST

Part No.	Re- marks	Description	Q'Ty	Ref. No.
<b>TU-7 (GENERAL)</b>				
B50-8045-00	N	Instruction manual	1	
E31-3150-05	N	Cable assembly	1	
G13-0826-04	N	Cushion	1	
G31-0826-04		Foam spacer	1	
H01-4679-03	N	Carton (Inside)	1	
H25-0029-04		Protective bag	2	
J32-0791-04	N	Hex. head boss	1	
N35-2604-41		Binding screw	2	
X52-1330-20	N	Tone unit	1	
<b>TONE UNIT (X52-1330-20)</b>				
CE04CW1A100M		Electro 10 $\mu$ 10V	1	C4
CK73EB1H473K		Chip cap. 0.047 $\mu$	1	C2
C91-0757-05		Ceramic 0,001 $\mu$	1	C3
E40-5021-05		Mini-connector 7P	1	
L78-0018-05	N	Ceramic oscillator	1	X1
R12-3445-05		Trimming pot. 47k $\Omega$	1	VR1
MB88306	N	IC	1	IC2
S7116A	N	IC	1	IC1

### TU-7 PC BOARD VIEW

(X52-1330-20) Component side view

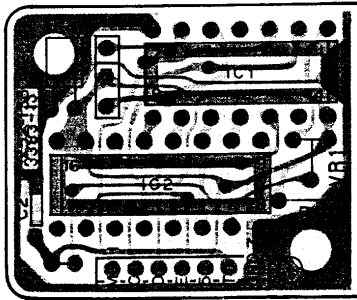

### TU-7 SCHEMATIC DIAGRAM

(X52-1330-20)

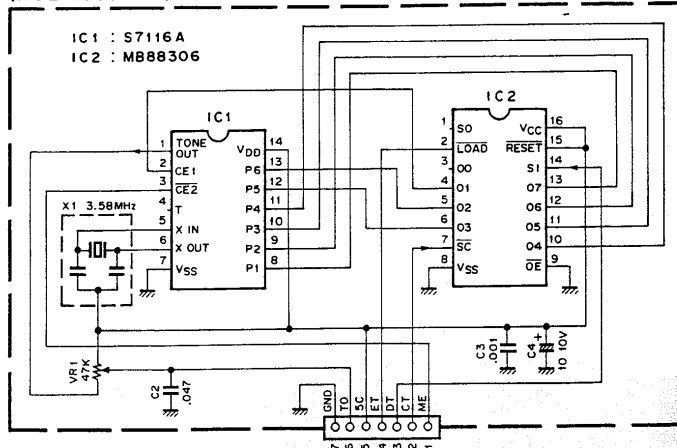

## VS-1 (VOICE SYNTHESIZER)

### VS-1 SCHEMATIC DIAGRAM

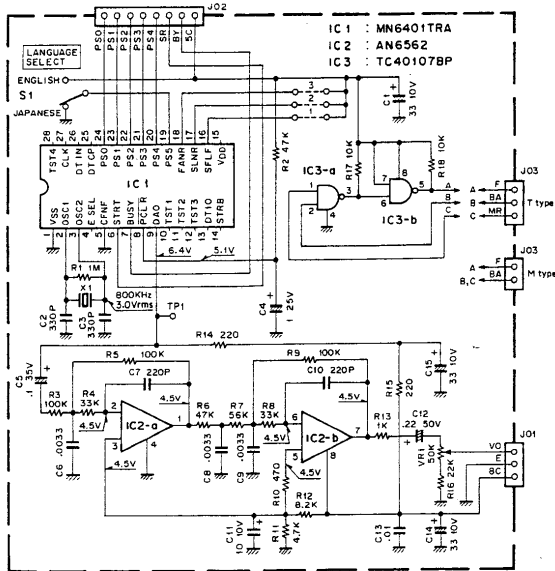

Scan by Dah

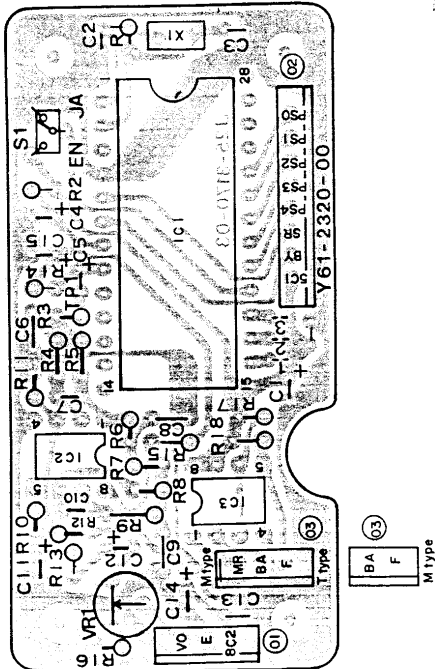

89

### VS-1 PARTS LIST

Part No.	Re- marks	Description	Ref. No.
B50-4035-00	N	Instruction manual	
CK45B1H331K	C	330P x 2	C2,3
CE04CW1A330M	E	33 10V	C1,14,15
CE04CW1A100M	E	10 10V	C11
CE04CW1HR22M	E	0.22 50V	C12
CK45B1H221K	C	220P x 2	C7,10
CO92M1H332K	ML	0.0033 x 3	C6,8,9
CS15E1E010M	T	1, 25V	C4
CS15E1V0R1M	T	0.1 35V	C5
C91-0131-05	C	0.01 (SP)	C13
E40-0273-05	Δ	Mini connector 2P	M J03
E40-0373-05	Δ	Mini connector 3P	M J01
E40-0373-05	Δ	Mini connector x 2 3P	T J03,J01
E40-0873-05	Δ	Mini connector 8P	J02
H01-4481-03	NΔ	Packing carton (inside)	M
H01-4501-03	NΔ	Packing carton (inside)	T
H25-0029-04		Protective bag x 2	
L78-0006-05	N	Ceramic OSC	X1
N89-3006-46		Tapping screw x 4	
R12-4408-05		Trim. pot. 50kΩ	VR1
S31-1411-05	N	Slide switch	S1
AN6562	N	IC	IC2
MN6401TRA	N	IC	IC1
TC40107BP	N	IC	IC3

### TALK SPEED SELECTION

Speed is factory set at "standard" talk speed. Three different speeds can be selected.

Note: When placing the jumper, solder carefully.

Speed	Std. speed	30% more than Std.	60% more than Std.
Jumper place			
1	X	X	O
2	X	X	O
3	X	O	X

Symbol O, denotes the place in which a jumper wire is placed.

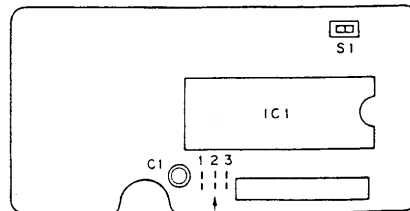

The place which a jumper wire to be placed.

BLOCK DIAGRAM

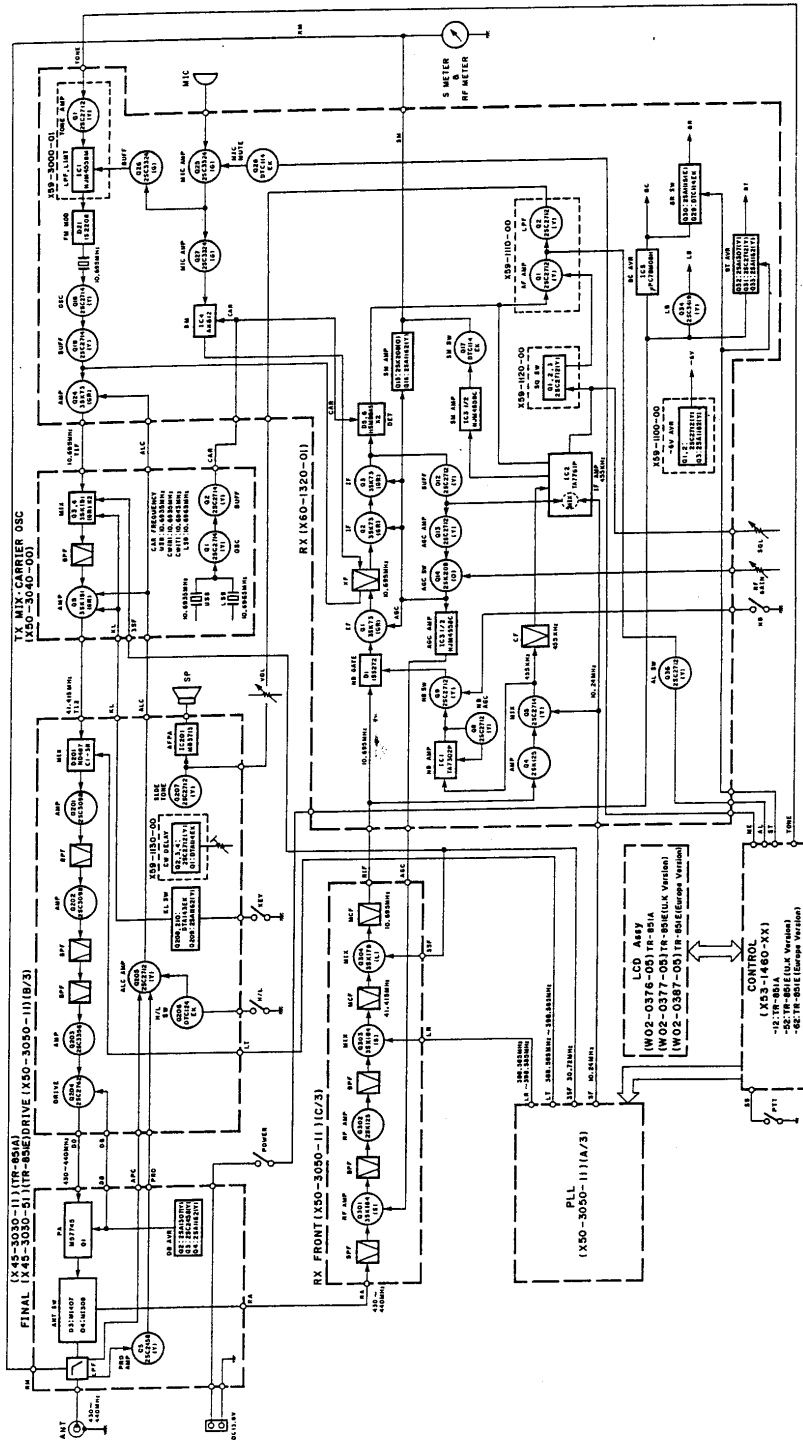

TR-851A/851E

# TR-851A/E

## SPECIFICATIONS

Specification		Model	TR-851A/E	
Frequency range			430 to 440 MHz	
Mode			USB/LSB (J3E), CW (A1A), FM (F3E, F2D for the control signal of the DCL system)	
Antenna impedance			50 ohms	
Power requirement			13.8 VDC $\pm$ 15%	
Grounding			Negative	
General	Current drain	Receive mode with no input signal	0.8 A	
		Transmit mode (Max.)	7.5A	
Frequency stability (-20°C to +60°C)			Better than $\pm 20 \times 10^{-6}$	
Operating temperature			-20°C to +60°C (-4°F to +140°F)	
Dimensions (W x H x D) (Projections included)			180 x 63 x 233 mm	
Weight			2.5 kg (5.5 lbs)	
Transmitter	Output power *	HI	25 W	
		LOW	5 W (Adjustable up to out 25 W)	
	Modulation	USB/LSB	Balanced modulation	
		FM	Reactance modulation	
	Spurious radiation			Less than -60 dB
	Carrier suppression (SSB)			More than 40 dB
	Unwanted sideband suppression (SSB)			More than 40 dB
	Maximum frequency deviation (FM)			$\pm$ 5 kHz
	Audio distortion (FM, at 60% modulation)			Less than 3% (300 to 3000 Hz)
	Microphone impedance			500 to 600 ohms
Circuitry	USB/LSB/CW		Double conversion superheterodyne	
	FM		Tripple conversion superheterodyne	
Intermediate frequency			41.415 MHz/10.695 MHz/455 kHz (FM only)	
Receiver	Sensitivity	USB/LSB/CW (10 dB S+N/N)	Less than 0.11 $\mu$ V	
		FM (12 dB SINAD)	Less than 0.18 $\mu$ V	
Selectivity	USB/LSB/CW	-6 dB	More than 2.2 kHz	
		-60 dB	Less than 4.8 kHz	
	FM	-6 dB	More than 12 kHz	
		-60 dB	Less than 24 kHz	
Spurious response			Better than 60 dB	
RIT variable range			More than $\pm$ 1.2 kHz	
Squelch sensitivity			Less than 0.1 $\mu$ V	
Output			More than 2 W across 8 ohms load (5% distortion)	
External speaker impedance			8 ohms	
DCL control	Code		NRZ equal-length code	
	Modulation		MSK modulation	
	Frequency deviation		$\pm$ 3.5 kHz (Reference)	
	Mark frequency and deviation		1200 Hz, $\pm 2 \times 10^{-4}$	
	Space frequency and deviation		1800 Hz, $\pm 2 \times 10^{-4}$	
	Code transmission speed and deviation		1200 bits/second, $\pm 2 \times 10^{-4}$	

**Notes:**

1. Circuit and ratings are subject to change without notice due to advancements in technology.
2. \* Recommended duty cycle  
1 minute : Transmission  
3 minutes: Reception