

TRIO

SERVICE MANUAL

MODEL **TR-2E**

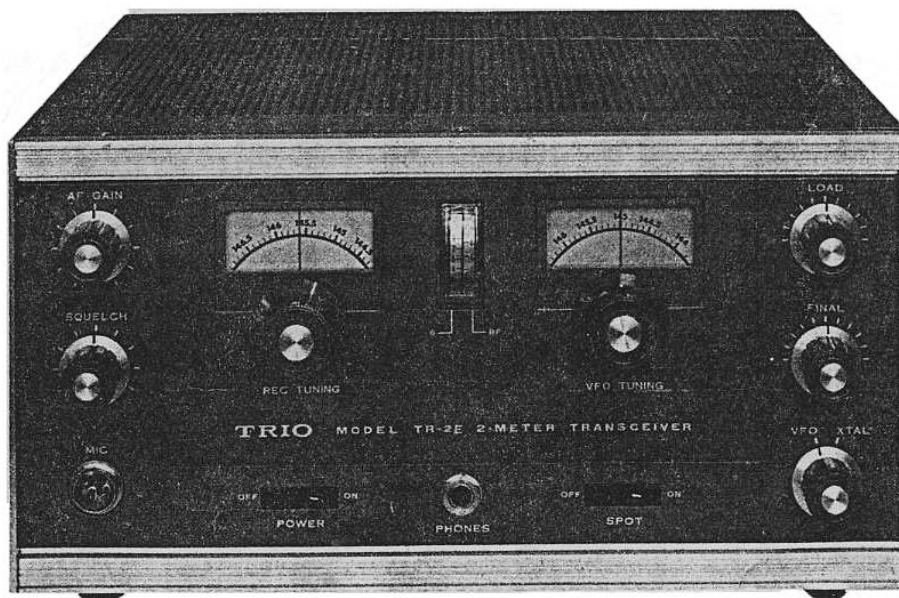

2-METER BAND TRANSCEIVER

PARTS DESCRIPTION LIST

CAPACITORS

Symbol No.	Description	Symbol No.	Description
C1,2	Ceramic 0.001mfd±20%	C61	Paper Tubular 0.001mfd±20%
C3	Ceramic 0.5mmfd±20%	C62,63	Ceramic 200mmfd±10%
C4	Ceramic 2mmfd±10%	C64	Electrolytic 10mfd 50WV
C5	Ceramic 0.001mfd+100%, -0%		Tubular
C6	Ceramic 1mmfd±10%	C65	Electrolytic 3mfd 350WV
C7	Ceramic 5mmfd±10%		Tubular
C8~11	Ceramic 0.001mfd+100%, -0%	C66~68	Paper Tubular 0.001mfd±20%
C12	Ceramic 10mmfd±10%	C69	Electrolytic 10mfd 50WV
C13	Ceramic 0.001mfd+100%, -0%		Tubular
C14	Made by twisting two insulated wires 1 inch	C70	Ceramic 0.001mfd+100%, -0%
C15	Ceramic 15mmfd±10%	C71	Paper Tubular 0.001mfd±20%
C16	Ceramic 0.001mfd+100%, -0%	C72	Ceramic 0.001mfd+100%, -0%
C17	Ceramic 1mmfd±10%	C73	Ceramic 200mmfd±10%
C18	Ceramic 47mmfd±5%	C74	Ceramic 1mmfd±10%
C19	Mica 100mmfd±5%	C75	Metalized Paper 0.5mfd±20%
C20	Mica 200mmfd±5%	C76,77	Ceramic 0.0047mfd+100%, -0%
C21	Mica 50mmfd±5%	C78,79	Ceramic 30mmfd±5%
C22	Ceramic 0.001mfd±20%	C80	Ceramic 100mmfd±5%
C23	Ceramic 5mmfd±10%	C81	Mica 100mmfd±5%
C24,25	Ceramic 0.0047mfd+100%, -0%	C82	Mica 500mmfd±5%
C26	Ceramic 20mmfd±10%	C83	Mica 250mmfd±5%
C27	Ceramic 0.0047mfd+100%, -0%	C84	Ceramic 0.001mfd±20%
C28	Ceramic 390mmfd±20%	C85	Ceramic 0.01mfd+100%, -0%
C29	Ceramic 10mmfd±10%	C86	Ceramic 10mmfd±10%
C32~38	Ceramic 0.0047mfd+100%, -0%	C87,88	Ceramic 0.01mfd+100%, -0%
C39	Ceramic 0.01mfd+100%, -0%	C89	Ceramic 20mmfd±10%
C40	Ceramic 47mmfd±10%	C90	Ceramic 0.01mfd+100%, -0%
C41	Ceramic 0.01mfd+100%, -0%	C91	Ceramic 47mmfd±10%
C42	Ceramic 400mmfd±20%	C92	Ceramic 0.0047mfd+100%, -0%
C43	Ceramic 0.01mfd+100%, -0%	C93	Ceramic 15mmfd±10%
C44	Ceramic 2mmfd±10%	C94	Ceramic 0.0047mfd+100%, -0%
C45~48	Ceramic 0.01mfd+100%, -0%	C95	Ceramic 20mmfd±10%
C49	Ceramic 2mmfd±10%	C96~98	Ceramic 0.0047mfd+100%, -0%
C50	Ceramic 200mmfd±10%	C99~102	Ceramic 0.001mfd+100%, -0%
C51	Ceramic 0.01mfd+100%, -0%	C103	Ceramic 0.001mfd±20%
C52	Ceramic 200mmfd±10%	C104	Paper Tubular 0.1mfd±20%
C53	Metalized Paper 0.1mfd±20%	C105	Ceramic 0.001mfd±20%
C54,55	Paper Tubular 0.01mfd±20%	C106,107	Ceramic 0.0047mfd+100%, -0%
C56	Ceramic 400mmfd±20%	C108~110	Ceramic 0.01mfd+100%, -0%
C57	Metalized Paper 0.1mfd±20%	C111~113	Paper Tubular 0.01mfd±20%
C58	Ceramic 100mmfd±10%	C114,115	Ceramic 0.01mfd+100%, -0%
C59	Ceramic 200mmfd±10%	C116	Paper Tubular 0.01mfd±20%
C60	Electrolytic 3mfd 350WV Tubular	C117	Electrolytic 100mfd 25WV Tubular
		C118	Electrolytic 100mfd 450WV Tubular

PARTS DESCRIPTION LIST

Symbol No.	Description	Symbol No.	Description
C119,120	Electrolytic Tubular 40mfd 350WV	R29	Composition 33K±5% 1/2W
C121	Ceramic 0.01mfd+100%, -0%	R30	Composition 1K±5% 1/2W
C122	Ceramic 390mmfd±20%	R31	Composition 100K±5% 1/4W
C123	Ceramic 0.01mfd+100%, -0%	R32	Composition 330ohm±5% 1/2W
C124,125	Ceramic 0.002mfd+100%, -0%	R33	Composition 56K±5% 1/2W
C126	Metalized Paper 1mfd±20%	R34	Composition 1M±5% 1/2W
TC1	Ceramic TRIM C4032	R35	Composition 2.2K±5% 1/2W
TC2~9	Cylinder TRIM C08-100D	R36	Composition 47K±5% 1/4W
TC10	Steatite TRIM C09-40E	R37	Composition 1M±5% 1/4W
VC1	REC TUNING 25mmfd D01-126	R38	Composition 330K±5% 1/4W
VC2	VFO TUNING 25mmfd D01-126	R39	Composition 150K±5% 1/4W
VC3	FINAL PLATE TUNING 10mmfdx2 D02-10B	R40,41	Composition 1M±5% 1/4W
VC4	FINAL TUNING 50mmfd D02-50	R42	Composition 47K±5% 1/2W
VC5	LOAD TUNING 50mmfd D02-50	R43,44	Composition 100K±5% 1/2W
RESISTORS			
Symbol No.	Description	Symbol No.	Description
R1	Composition 2.2M±5% 1/4W	R45	Composition 100K±5% 1/4W
R2,3	Composition 100K±5% 1/4W	R46	Composition 470K±5% 1/4W
R4	Composition 4.7K±5% 1/2W	R47	Composition 1.8K±5% 1/2W
R5	Composition 220K±5% 1/4W	R48	Composition 220K±5% 1/2W
R6	Composition 330ohm±5% 1/2W	R49	Composition 22K±5% 1/2W
R7	Composition 470K±5% 1/2W	R50	Composition 2.7K±5% 1/2W
R8	Composition 56K±5% 1/2W	R51	Composition 330K±5% 1/2W
R9	Composition 39K±5% 1/4W	R52	Composition 10K±5% 1/2W
R10	Composition 10K±5% 1/2W	R53	Composition 470K±5% 1/2W
R11	Composition 39K±5% 1/4W	R54	Composition 1.8K±5% 1/2W
R12	Composition 150ohm±5% 1/2W	R55,56	Composition 100K±5% 1/2W
R13	Composition 33K±5% 1/2W	R57,58	Composition 470K±5% 1/2W
R14	Composition 4.7K±5% 1/2W	R59	Wire Wound 220ohm±5% 4W
R15	Composition 82ohm±5% 1/4W	R60	Composition 330ohm±5% 1/2W
R18	Composition 1M±5% 1/4W	R61	Composition 1K±5% 1/4W
R19	Composition 330ohm±5% 1/2W	R62	Composition 1K±5% 1/2W
R20	Composition 2.2M±5% 1/2W	R63	Composition 10K±5% 1/2W
R21	Composition 1K±5% 1/2W	R64	Composition 33K±5% 1/4W
R22	Composition 100K±5% 1/4W	R65	Composition 5.6K±5% 1/2W
R23	Composition 150ohm±5% 1/2W	R66	Composition 100K±5% 1/4W
R24	Composition 33K±5% 1/2W	R67	Composition 150ohm±5% 1/2W
R25	Composition 22K±5% 1/2W	R68	Composition 1.2K±5% 1/2W
R26	Composition 1.5K±5% 1/2W	R69	Composition 100K±5% 1/2W
R27	Composition 330ohm±5% 1/2W	R70	Composition 33K±5% 1/2W
R28	Composition 47K±5% 1/4W	R71	Composition 1K±5% 1/2W
		R72	Composition 47K±5% 1/2W
		R73	Composition 22K±5% 1/2W
		R74	Composition 47K±5% 1/2W
		R75	Composition 10K±5% 1/2W
		R76	Composition 15K±5% 1/2W
		R77	Composition 22K±5% 1/2W
		R78	Composition 100K±5% 1/2W
		R79~82	Composition 2.2ohm±5% 1/2W
		R83	Wire Wound 24ohm±10% 2W
		R84	Wire Wound 680ohm±10% 8W

PARTS DESCRIPTION LIST

TUBES/NUVISTOR

Symbol No.	Description		
R85,86	Wire Wound	1K±10%	20W
R87	Wire Wound	6K±10%	8W
R88	Wire Wound	220ohm±10%	4W
R221	Composition	330K±5%	1/2W

Symbol No.	Description	
V1	6CW4	RF Amp.
V2a	6BL8 (P)	1st Mix.
V3a	6BL8 (T)	OSC
V3b	6BL8 (P)	OSC Buff.
V4	6CB6	2nd Mix.
V5	6BA6	2nd IF Amp.
V6	6BE6	3rd Mix. XTAL OSC
V7	6BA6	3rd IF Amp.
V8	12AV6	SPEECH Amp.
V9a	12AX7 1/2	AF Amp.
V9b	12AX7 1/2	PHASE Inv.
V10,11	6AQ5	PA Amp.
V12a	6AQ8 1/2	VFO
V12b	6AQ8 1/2	VFO Buff. XTAL OSC
V13	6AU6	24MHz TRIPLER
V14	12BY7A	72MHz TRIPLER
V15	12BY7A	144MHz DOUBLER
V16	6360	FINAL PA Amp.
V17	0A2/VR-150	Stabilizer

COILS/TRANSFORMERS

Symbol No.	Description	Part No.
L1	ANT Coil (A)	L10-13
L2	ANT Coil (B)	L10-14
L3	RF Coil (A)	L12-27
L4	RF Coil (B)	L12-28
L5	RF Coil (C)	L12-29
L6	RF Coil (D)	L12-30
L7	OSC Coil (A)	L11-55
L8	OSC Coil (B)	L11-56
L9	TRIPLE Coil	L13-91
L10,11	IFT	L02-52
L12	IFT	L01-47
L13	IFT	L01-51
L14	VFO OSC Coil	L11-58
L15	VFO OUTPUT Coil	L13-85
L16	24MHz DOUBLER Coil	L13-86
L17	72MHz DOUBLER Coil	L13-87
L18	144MHz DOUBLER Coil	L13-88
L19	FINAL Coil	L13-89
L20	OUTPUT Coil	L13-84
L21,22	FILTER Coil	L20-150
CH1-3	Choke Coil 3µH	L20-030
CH4	Choke Coil 1mH	L13-90
CH5,6	Heater Choke Coil	L22-01
T1	MODULATION Transformer	T04-05
P.T	POWER Transformer	T01-182M

TRANSISTORS/DIODES

Symbol No.	Description	
Q1-4	2SB449	DC Converter
D1	1S72	OSC Triple
D2	1S72	Detector
D3	1S72	Noise Limiter
D4	FR-1M	Squelch
D5	1N60	Meter RF Det.
D6,7	FR-1K	Rectifier
D8	FR-1M	Relay Rec.
D9	SM-150	Starting

SWITCHES

Symbol No.	Description	Part No.
S1	XTAL-VFO Rotary M-1.3.2	S04-133
S2	SPOT	S10-22J
S3	POWER	S10-11A
S4	AC SELECTOR	S10-22D

POTENTIOMETERS

Symbol No.	Description	Part No.
VR1	100K (B) SQUELCH	R01-0194
VR2	500K (A) AF GAIN	R01-0193
VR3	500K (A) SPEECH GAIN	R01-0192
VR4	5K (B) S-ZERO Adj.	R01-0191

PARTS DESCRIPTION LIST

MISCELLANEOUS

<u>Symbol</u>	<u>Description</u>	<u>Part No.</u>	<u>Symbol</u>	<u>Description</u>	<u>Part No.</u>
<u>No.</u>	<u>Description</u>	<u>Part No.</u>	<u>No.</u>	<u>Description</u>	<u>Part No.</u>
-	Case	A01-LA946	-	Knob REC TUNING, VFO TUNING	S14-616
-	Chassis	A03-LA94	-	Knob AF GAIN, SQUELCH, LOAD, FINAL, VFO-XTAL	S14-256
-	Sub Chassis	A04-LA94	-	Fuse Holder	S15-03B
-	Panel	A05-LA946	PL1,2	Pilot Lamp	S16-12
-	Sub Panel	A06-LA946	F2	Fuse 2A	S17-02
-	Dial Scale (REC)	A07-LA946A	F1	Fuse 15A	S17-10
-	Dial Scale (VFO)	A07-LA946B	-	Shaft Coupling	S4013
-	MT Socket (7P)	E01-17J	-	RELAY 1	S4088
-	MT Socket (9P)	E01-19J	-	RELAY 2	S4105
-	Pilot Lamp Socket	E03-02F	M	S Meter	T11-69
J	Jack (12P)	E07-212	-	Crystal 10.245MHz	T13-58
-	Plug (12P)	E09-212	-	Microphone	T22-11
-	Nuvistor Socket	E4066			
J	US Jack	E16-09			
-	Shield Case (7P)	E24-06			
-	Shield Case (9P)	E24-01			
-	Crystal Socket	E4014			
-	Crystal Socket	E4008			
-	Transistor Socket	E4070			

CHASSIS TOP VIEW

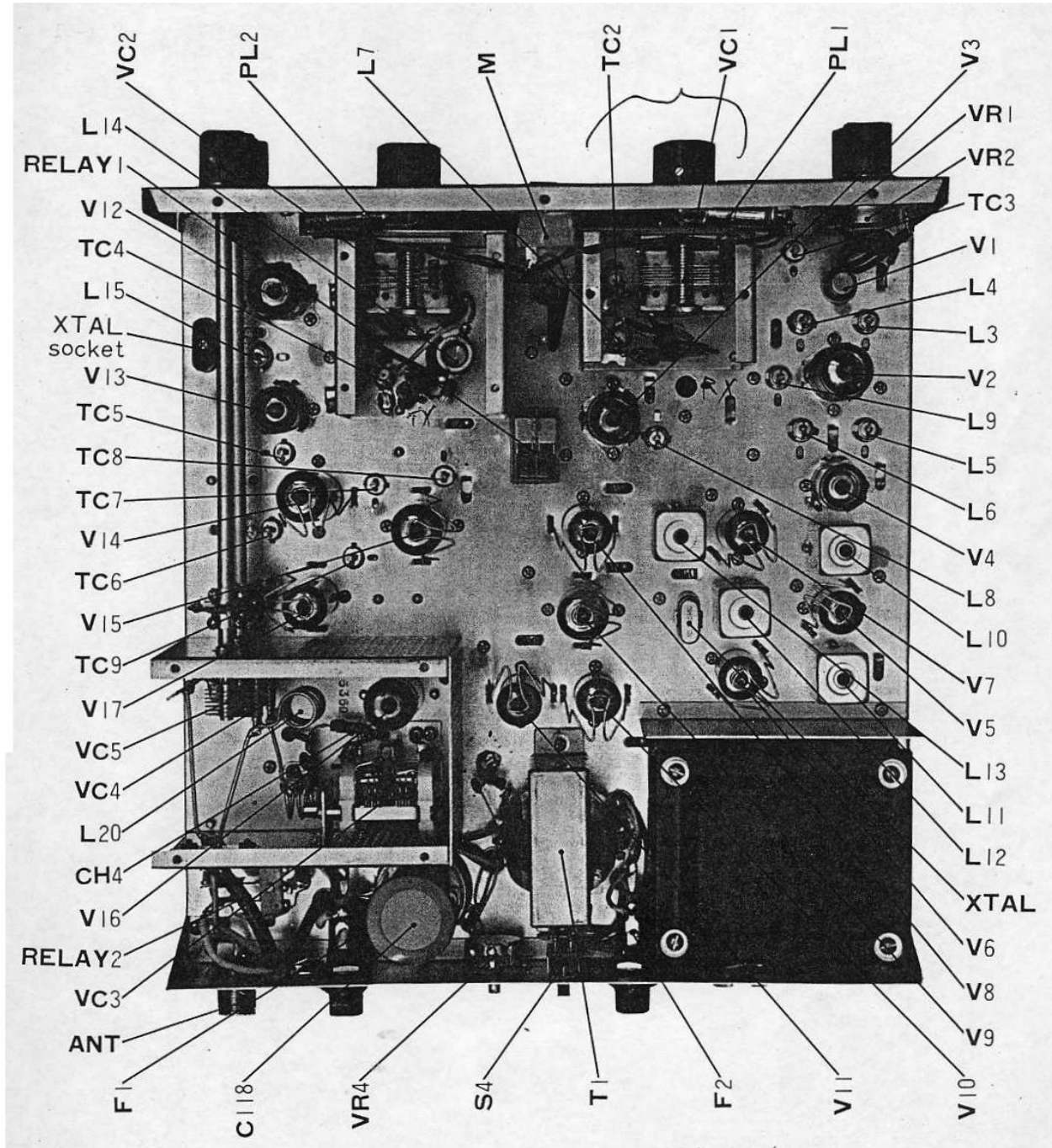

CHASSIS BOTTOM VIEW

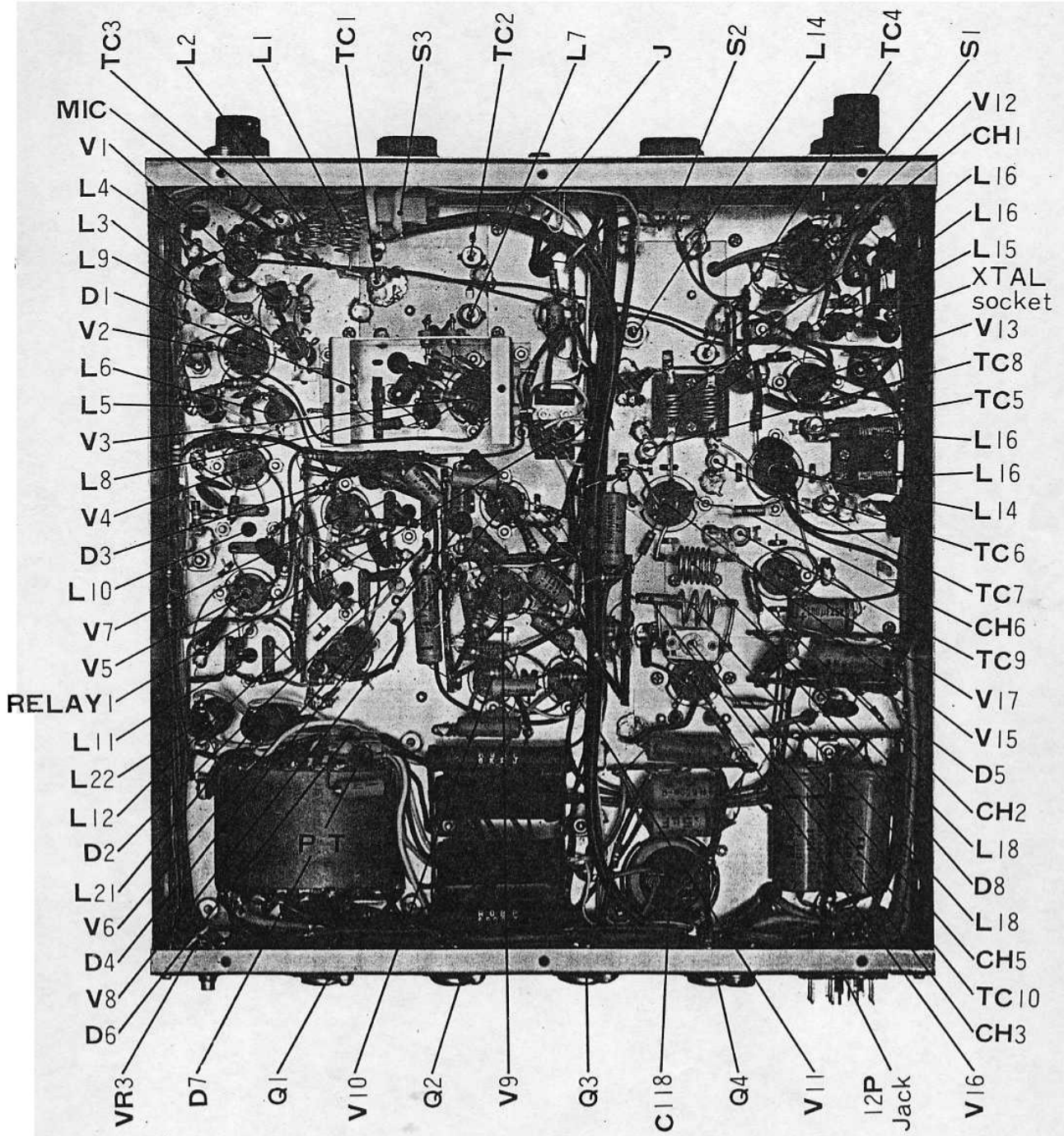

BLOCK DIAGRAM

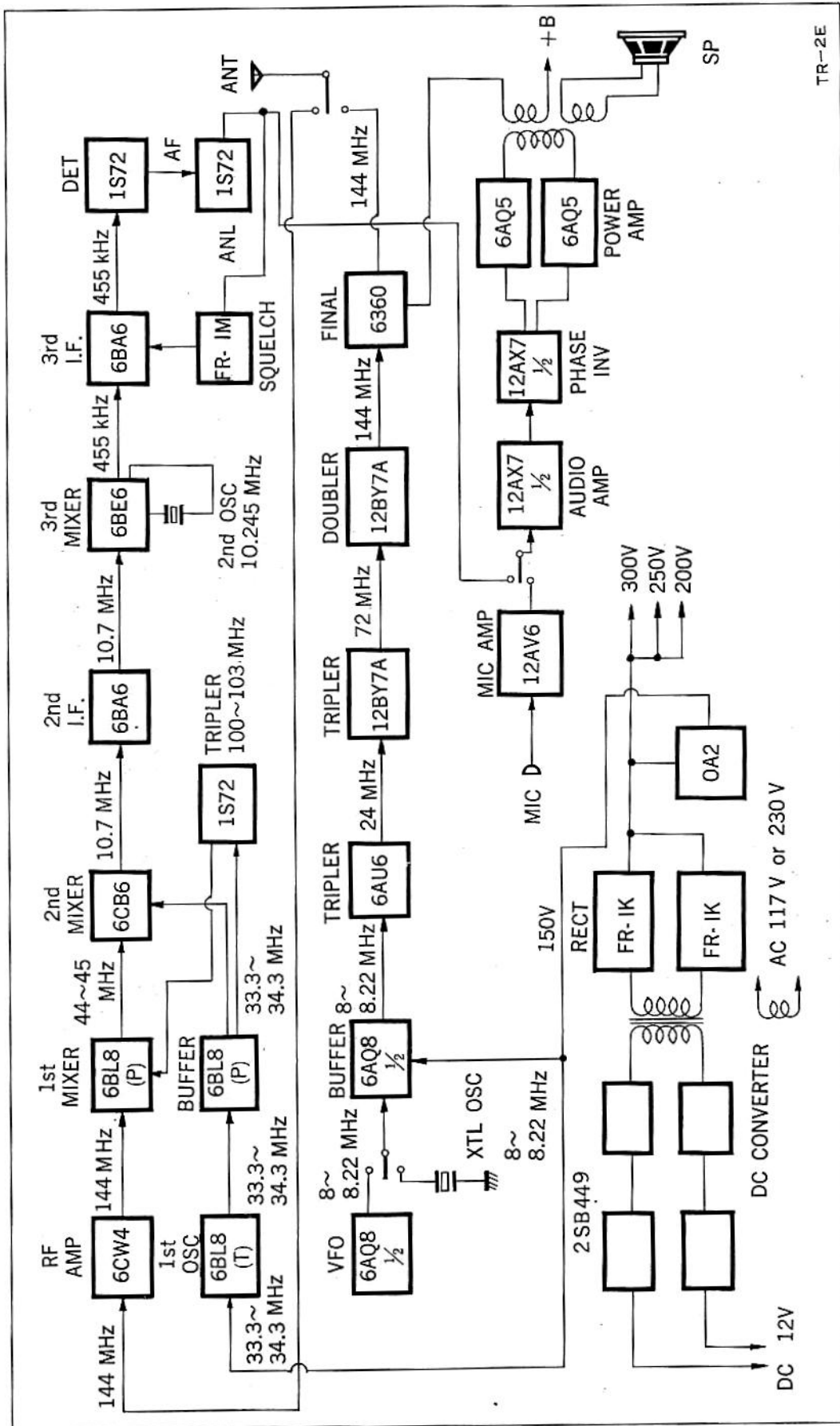

TR-2E

ALIGNMENT PROCEDURE

1. RECEIVER SECTION

1.1 Alignment of the 3rd I.F. Transformer (455 kHz)

Test Equipments: Sweep Generator, Oscilloscope.

Step (a). Connect the Sweep Generator output cable to the receiver detector output [junction of R36 (47 Kohm) and R37 (1 Megohm); C52 (200P)].

Step (b). Connect the vertical input leads of the oscilloscope across G1 of V7 6BA6 (Pin 1) and the receiver's chassis.

Step (c). The characteristic curve of the I.F. transformer will appear on the scope screen as the sweep output level is increased. Adjust both the top and bottom slugs of L13 so that maximum response is obtained at 455 kHz. Next, leave the audio lead as is, and connect the RF lead to G3 of V6 6BE6 (pin 7). Adjust the top and bottom slugs of the IFT (L12) for maximum response. Repeat the slug adjustments of L13 and L12 once again to obtain good characteristic response as shown below. (See Figure 1)

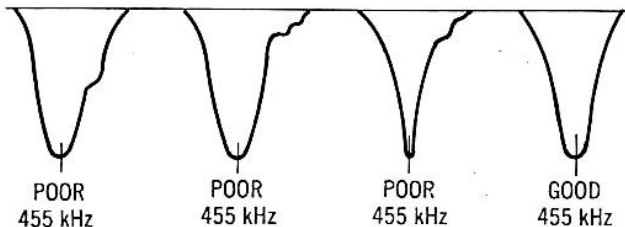

Figure 1

1.2 Alignment of the 2nd I.F. (10.7 MHz)

Test Equipments - AM Signal Generator capable of producing 10.7 MHz signal; 8 ohm Dummy Resistor, Oscilloscope or Audio VTVM.

Step (a). Connect the dummy load and the VTVM or oscilloscope across the speaker terminals.

Step (b). Connect the output of the Signal Generator to G1 of V4 6CB6 (pin 1). Insert a 10.7 MHz signal, modulated 30% by a 1000 Hz sine wave.

Step (c). Adjust the primary and secondary slugs of the IFT (L10, L11) alternately for maximum audio output response.

Step (d). After completing this 10.7 MHz alignment, the 455 kHz alignment as outlined above should be repeated for maximum response. This is to compensate for any frequency discrepancy of the 2nd Crystal Oscillator.

1.3 Alignment of the First Oscillator

Test Equipments - Frequency Counter, Wave Meter or Crystal Calibrated Oscillator; RF VTVM.

Step (a). Connect the Frequency Counter to the plate side of L8 through a capacitor of about 5PF. Set the receiver's tuning dial to 144 MHz, and adjust the slug of the Oscillator Coil (L7) so that its resonant frequency is 33.3 MHz.

Next set the receiver dial to 148 MHz and adjust the Piston Trimmer (TC-2) so that the Oscillator frequency becomes 34.3 MHz. Repeat the above steps several times. Frequency values may be approximate, as they are not too critical at this stage.

Step (b). Connect the RF VTVM to the plate side of L8 through a capacitor of about 5 PF. Set the receiver dial to 145 MHz and adjust the slug of L8 so that maximum Oscillator output is obtained.

Step (c). Repeat the adjustments outlined under Step (a), but this time connect the Frequency Counter to the output side of condenser C17 (1PF). Special care must be taken to make an accurate adjustment this time as the circuit's passband and dial calibration will be determined by this adjustment.

ALIGNMENT PROCEDURE

1.4 Alignment of the 1st I.F. (44-45 MHz)

Test Equipments: AM Signal Generator capable of producing a 44 to 45 MHz signal; 8 ohm Dummy resistor; Oscilloscope or VTVM.

Step (a). Connect the Signal Generator to G1 of V2 6BL8 (pin 2) and the dummy resistor and oscilloscope or VTVM across the speaker terminals.

Step (b). Set the receiver dial to 144 MHz and tune the Signal Generator to obtain maximum audio output (44 MHz). Now adjust the slugs of L5 and L6 alternately for maximum audio response. Next set the dial to 148 MHz and the Signal Generator to 45 MHz and observe the audio response level. Now adjust L5 and L6 so that about the same response level is obtained as before at 44 MHz. In addition, the band width is determined by adjusting the length of the vinyl lead of C14 0.5P.

1.5 RF Alignment

Test Equipments: AM Signal Generator capable of producing 144 to 148 MHz signal; 8 ohm dummy resistor; Oscilloscope or VTVM.

Step (a). Connect the Signal Generator to the Antenna Jack and the dummy resistor, oscilloscope or VTVM across the speaker terminals.

Step (b). Set the receiver dial to 145.5 MHz and insert a 145.5 MHz signal modulated 30% by a 1000 Hz audio sine wave. Adjust signal generator level so that a 50 mW audio output is obtained.

Step (c). Adjust TC-1 so that maximum audio output is obtained, and then TC-3 also for maximum response. Now adjust the slugs of L3 and L4 alternately for maximum response.

Step (d). It is recommended that the audio output be held down to around 50 mW when making these adjustments.

This will facilitate alignment work. The signal generator output level can be started high at about 40 dB, and gradually lowered as receiver sensitivity increases. At the point of perfect alignment, S/N will equal 10 dB when 6 dB equals 2 microvolts.

After completing this step, make response checks at 1 MHz intervals from 144 MHz up to 148 MHz.

2. TRANSMITTER SECTION

2.1 VFO Alignment

Test Equipments - Frequency Counter or Wave Meter; RF VTVM.

Step (a). Couple the Frequency Counter through a 10 PF capacitor to G1 of V13 6AU6 (Pin 1). Now set VFO-XTAL Switch to VFO and the SPOT switch to ON.

Step (b). Set the VFO Tuning Dial to 144 MHz and adjust the slug of the VFO Oscillator Coil (L14) so that the oscillation frequency is 8 MHz. Now set the VFO dial to 148 MHz and adjust the Piston Trimmer (TC-4) so that oscillation frequency becomes 8.222 MHz. Repeat these adjustments so that the dial readings between 144 to 148 MHz approximately correspond to oscillation frequencies of 8 to 8.222 MHz.

Step (c). Set the VFO dial to the center frequency of 146 MHz and connect the RF VTVM to G1 of V13 6AU6. Now adjust the slug of the VFO Output Coil (L15) so that maximum deflection is obtained on the VTVM.

Step (d). The oscillation frequency may shift slightly because of the above step. Therefore Step (b) should be repeated once again to make sure that frequencies are adjusted correctly.

ALIGNMENT PROCEDURE

2.2 Confirming the Oscillation of the Crystal Oscillator

Set the VFO-XTAL switch to XTAL. Insert an 8 to 8.222 MHz crystal into the crystal holder and switch the SPOT Switch to ON. A check to determine whether the crystal is oscillating properly can be made by measuring the voltage at G1 of V13 6AU6 with a RF VTVM. If this voltage drops when the VFO-XTAL Switch is switched to XTAL, it indicates that the crystal is oscillating properly. The S-Meter deflections of the receiver can also be observed to make this check.

2.3 24 MHz Multiplier Adjustment

Test Equipment: DC VTVM.

Step (a). To protect V16 6360, cut off the B+ power supply from its plate and screen grid. Place the VFO in operation, and turn the SPOT switch to OFF. Ground pin 4 of the Microphone Connector by shorting it to the chassis with a clip cord, and place the transmitter in operation.

Step (b). Set the DC VTVM for minus voltage measurement, and connect it across the 47 K ohm R72 on the secondary (ground side) of the 24 MHz Multiplier coil L16.

Next adjust the Piston Trimmers TC-5 and TC-6 for maximum deflection of the VTVM after setting the VFO dial to 144 MHz. Now slowly turn the VFO dial from 144 MHz to 148 MHz while noting the deflection changes of the VTVM, that is, the change in the minus grid voltages of V14 12BY7A. Adjustment is correct if the plotting of the VTVM movements results in a curve such as is shown in Figure 2, (A). If, however, the frequency band width is narrow as in Figure 2, (B) or in case it is too wide, the space between the primary

and secondary coils of L16 must be adjusted to obtain a curve as shown in Figure 2, (A).

This space should be narrowed if the frequency band width is too narrow, and opened up if the band width is too wide. If this space adjustment is made, Trimmers TC-5 and TC-6 must always be readjusted as explained above.

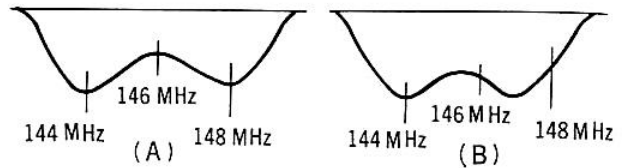

Figure 2

2.4 72 MHz Multiplier Adjustment

Test Equipments: DC VTVM, Frequency or Wave Meter.

Step (a). Connect the DC VTVM across the 47 Kohm R74 on the secondary of L17 (chassis side). Otherwise, the adjustment of this stage is accomplished in exactly the same way as outlined above for the 24 MHz Multiplier stage.

Step (b). When the band width adjustment has been completed, connect a Frequency Counter through 5PF condensers to both sides of the 47 Kohm R74. Ascertain whether frequency is 72 MHz with the VFO dial set at 144 MHz, and 74 MHz with the VFO dial at 148 MHz.

This is necessary since the frequency here is nine times that of the fundamental frequency. Thus, any discrepancy in the fundamental frequency will result in a significant frequency error here, which will necessitate adjustment. Moreover, any error here will show up twice as large in the final stage. If correction is made here, there will be no need of rechecking frequency in the final stage.

ALIGNMENT PROCEDURE

2.5 144 MHz Multiplier Adjustment

Test Equipments: DC Milliammeter (0-10 mA) or VOM Meter set to this range.

Step (a). Insert the milliammeter between the 15 Kohm R76 and the chassis, connecting the plus probe to the chassis and the minus probe to the resistor.

Step (b). Adjustment is accomplished in the same manner as for the previous multiplier stages outlined above. However, grid current is observed here, whereas grid voltage was observed in making adjustment for the previous multiplier stages.

Set the VFO dial to 144 MHz, and adjust TC-10 for maximum current flow. Now adjust TC-9 again for maximum current flow. Next, as the VFO dial is turned slowly, two peaks should be observed as shown in figure 3, the first near 144 MHz and the second near 148 MHz. See Figure 3.

The space between the coils must be adjusted so that a characteristic as shown above is achieved.

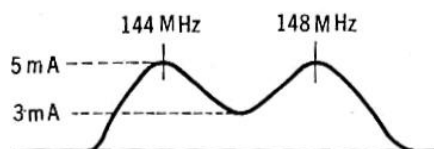

Figure 3

2.6 Adjustment of FINAL Output Circuit

Test Equipments: DC Milliammeter (0-100 mA); RF Watt meter (more than 150 MHz), 30 W.

Step (a). Connect the B+ power supply to the plate of V16 6360 and insert the Test Milliammeter into this lead. Also connect the B supply to the screen grid and place the tube in operation. Connect the RF watt meter across the ANT terminals.

Step (b). Set the VFO dial to 144 MHz; VC-5 (load capacitor) in completely meshed position; and the final capacitor VC-4 in one third meshed position.

Step (c). With the unit set for transmitting operation, turn the tank capacitor VC-3 quickly and set it to the point where minimum plate current is indicated by the milliammeter.

Now turn the final variable capacitor VC-4 slowly and adjust for minimum plate current. Plate current should read about 30mA when these adjustments are repeated. Now with VC-3 left as is, VC-5 is opened up slowly. A rise in plate current will be accompanied by a swing in the voltmeter. As VC-5 is further opened up, a point will be reached where the voltage begins to drop. Set VC-5 for maximum voltage. If VC-4 is now adjusted slightly, a further upward surge in voltage will occur. In this manner, VC-4 and VC-5 should be adjusted back and forth to obtain maximum voltmeter indication.

Next adjust the VFO dial to 144.5 MHz, and adjust VC-4 and VC-5 for maximum. Now adjust TC-10 and TC-9 slightly and a further deflection will result. These two trimmers should be left set at the point where maximum deflection has been obtained.

Step (d). Output indications should be checked at 144, 145, 146, 147 and 148 MHz points, which then completes the alignment of the transmitter.

More than 9 Watts power output is available at 144 - 146 MHz and more than 8 watts between 146 and 148 MHz.

(Note: Plate current should not exceed 100 mA even when power output is more than 9 watts. It is necessary to pay very special attention to the adjustment of VC-3, VC-4 and VC-5 which closely affects the relation between power input and power output.)

ALIGNMENT PROCEDURE

3. MODULATOR

Test Equipment: VOM Meter.

Step (a). There are no special adjustment points in the Modulator, but maximum power output cannot be achieved if the audio output tubes happen to be unbalanced. To check this, connect a VOM meter set at a low milliamperage range between the two plates of V10 and V11, both 6AQ5's.

No current flow will indicate perfect balance of these tubes. If a reading of more than 0.3 mA is indicated, however, either one or the other 6AQ5 must be changed so that current flow will read less than the above figure.

4. MEASUREMENT OF MODULATION

Test Equipments: Audio Generator, Oscilloscope with direct connection to the deflection plates of its CRT.

Step (a). Insert a 1000 Hz signal from the Audio Generator to the Microphone Input Jack. Connect the RF Output from the ANT Terminals through LPF capacitors to the DIRECT input terminals of the oscilloscope. Set the transmitter in operation at 145 MHz. Confirm that 100% modulation is obtainable by observing the CRT waveform as AG output is gradually increased. (Modulation Volume Control at maximum setting).

5. DC TEST

Step (a). With the unit set for DC battery operation, connect a 12.8 V DC battery, and check whether everything operates normally.

Step (b). Check whether transmitter power output, etc. correspond with the DC Operation Specifications listed on the Specifications page of this Operating Manual.

CORRECTION!!

Please Correct as Following.

PAGE	ERROR	CORRECT
P 2	R79~82 Composition 2.2ohm± 5% ½ W	R79~80 Composition 33ohm± 5% ½ W
	R83 Wire Wound 24ohm±10% 2 W R84 Wire Wound 680ohm±10% 8 W	R83,84 Wire Wound 130ohm±10% 4 W
P 3	Q1~4 2SB449 DC-DC Converter	Q1~4 2SB337 DC-DC Converter
	D9 SM-150 Starting	eliminate
P 7	2SB449	2SB337
P 8	<p style="text-align: center;">Q1~4 2SB449</p>	<p style="text-align: center;">Q1~4 2SB337</p>