

TM-3530A

144MHz FM TRANSCEIVER

TM-2570A

TM-2550A

TM-2550E

TM-2530A

INSTRUCTION MANUAL

TRIO-KENWOOD CORPORATION

Thank you for purchasing the new TM-3530A/2570A/2550A/2550E/2530A transceiver. Please read this instruction manual carefully before placing your transceiver in service. This unit has been carefully engineered and manufactured to rigid quality standards, and should give you satisfactory and dependable operation for many years.

This Instruction Manual covers the following models:

TM-3530A	220 MHz FM transceiver with KENWOOD brand.
TM-2570A	144 MHz FM transceiver with KENWOOD brand.
TM-2550A	144 MHz FM transceiver with KENWOOD brand.
TM-2550E	144 MHz FM transceiver with KENWOOD brand. (Europe version)
* TM-2550E	144 MHz FM transceiver with TRIO brand. (England version)
TM-2530A	144 MHz FM transceiver with KENWOOD brand.

*In the U.K. the TM-2550E is available under the brand name "TRIO". The TM-3530A/2570A/2550A/2550E/2530A with KENWOOD brand appearing in this instruction manual is not sold in the U.K., as they are made to a different market specification.

When there are differences in operation separate instructions will be given for each model. Illustrations show the TM-2550A.

The following explicit definitions apply in this manual:

Note: If disregarded, inconvenience only, no risk of equipment damage or personal injury.

Caution: Equipment damage may occur, but not personal injury.

CONTENTS

1. FEATURES	4	4-7-2. Storing a telephone channel in normal memory	22
2. SPECIFICATIONS AND ACCESSORIES	5	4-7-3. Automatic telephone number transmission.....	22
2-1. SPECIFICATIONS.....	5	4-8. DCL (Digital Channel Link) SYSTEM.....	23
2-2. ACCESSORIES	6	4-8-1. DCL system description	23
3. INSTALLATION AND CONNECTION	7	4-8-2. DCL system keyboard	25
3-1. INSTALLATION.....	7	4-8-3. Digital code entry	25
3-1-1. Precautions	7	4-8-4. Code squelch.....	26
3-1-2. Power supply.....	7	4-8-5. Channel linkage.....	27
3-1-3. Mounting bracket.....	8	4-8-6. Recall.....	30
3-2. CONNECTION.....	8	4-8-7. Reset and return.....	30
3-2-1. Precautions	8	4-8-8. Call sign entry.....	31
3-2-2. Fixed station.....	9	4-8-9. DCL system notes	32
3-2-3. Mobile	9	5. MAINTENANCE AND ADJUSTMENT	33
A. Battery	9	5-1. GENERAL INFORMATION	33
B. Ignition noise.....	9	5-2. SERVICE.....	33
3-2-4. Antenna.....	9	5-3. CLEANING.....	33
4. OPERATION	10	5-4. MICROPROCESSOR BACK-UP LITHIUM BATTERY REPLACEMENT	33
4-1. CONTROLS AND THEIR FUNCTIONS.....	10	5-5. ORDERING SPARE PARTS	33
4-1-1. Front panel	10	5-6. ADJUSTMENTS	34
1. LCD group	12	5-6-1. Cover removal.....	34
2. Keyboard.....	13	5-6-2. Low power output.....	34
4-1-2. Rear panel	14	5-6-3. Microphone gain	34
4-1-3. Microphone.....	14	5-6-4. DTMF level.....	34
4-2. RECEPTION	15	5-6-5. Sidetone and beeper level.....	34
4-3. TRANSMISSION	15	5-6-6. RF power meter.....	34
4-3-1. Precautions	15	5-6-7. TO (Timer Operated) scan timer.....	35
4-4. MEMORY.....	15	5-6-8. Open channel search step size selection.....	35
4-4-1. Microprocessor memory back-up	15	5-6-9. Microphone UP/DWN step size and scan step size selection	35
4-4-2. Initial state and reset of the microprocessor	15	5-6-10. Microprocessor reset pins	35
A. Initial state of the microprocessor from the factory	15	5-6-11. Call sign monitor test pins	35
B. Microprocessor reset	15	6. BLOCK DIAGRAM	36
4-4-3. Memory input.....	16	6-1. TM-3530A	36
4-4-4. Paired channels.....	16	6-2. TM-2570A	37
4-4-5. Priority channel select.....	17	6-3. TM-2550A/2530A	38
4-5. SCAN.....	17	6-4. TM-2550E.....	39
4-5-1. Memory scan from the keyboard	17	7. OPTIONAL ACCESSORIES	40
4-5-2. Programmable band-scan from the keyboard	18	7-1. TU-7 TONE UNIT.....	40
4-5-3. Scan direction	18	7-2. MU-1 MODEM UNIT	40
4-5-4. Scan speed.....	18	7-3. VS-1 VOICE SYNTHESIZER UNIT	41
4-5-5. Scan lockout (Skip)	18	7-4. OTHER ACCESSORIES.....	41
4-5-6. Scan release.....	18	8. REFERENCE	45
4-5-7. Priority channel scan (Alert).....	19	8-1. ANTENNA	45
4-6. REPEATER.....	19	8-1-1. Fixed station.....	45
4-6-1. Automatic repeater offset	19	8-1-2. Mobile	45
4-6-2. Tone frequency	20	8-2. MOBILE INSTALLATION	46
1. Setting.....	20	8-2-1. Noise reduction	46
2. Release	20	8-2-2. Battery capacity	46
4-7. AUTOMATIC TELEPHONE NUMBER TRANSMISSION SYSTEM.....	21		
4-7-1. Telephone number programming.....	21		

1. FEATURES

- **Easy-to-operate panel layout using a large LCD display**
The large LCD display shows operational conditions at a glance. The panel layout is ergonomically designed for easy operation.
- **Illuminated keys for easier operation**
Keyboard keys are back lit. Illumination is also provided for operational switches reducing mistakes in operation.
- **Dual microprocessor system**
Two microprocessors provide a versatile range of functions that has not been possible in the past.
- **High RF power output with excellent stability**
A high stability, high power output is also assured through the use of a heat sink that incorporates improved thermal design characteristics.
- **Microphone check function**
This is useful for checking the microphone and modulation circuits.

- **Automatic autopatch transmission (TM-3530A/2570A/2550A/2530A only)**
Autopatch operation has been simplified by incorporating the ability to store up to 15 telephone numbers in memory and then allow automatic dialing on command.
- **DCL system (optional)**
Using the latest in digital technology, this new communication system for amateur radio communications makes possible automatic open channel search, automatic station connection, code squelch (digital squelch), etc. (Fully compatible with KENWOOD' current DCS system.)
- **Voice synthesizer function**
The selected frequency, digital code and ASCII code may be announced by synthesized human voice. (This is provided by the optional VS-1 voice synthesizer.) [Telephone number may also be announced. (TM-3530A/2570A/2550A/2530A only)]
- **Improved tone function (TM-3530A/2570A/2550A/2530A only)**
38 subaudible tone frequencies can be selected and stored in memory or from the keyboard. (This is provided by installation of the optional TU-7 tone unit.)

2. SPECIFICATIONS AND ACCESSORIES

2-1. SPECIFICATIONS

Specification		Model	TM-3530A	TM-2570A	TM-2550A	TM-2550E	TM-2530A	
General	Frequency range		220 to 225 MHz	144 to 148 MHz		144 to 146 MHz	144 to 148 MHz	
	Mode		FM F3 (F3E), F2 (F2D) (Control signal for DCL system)					
	Antenna impedance		50 ohms					
	Power requirement		12 to 16 VDC (13.8 VDC reference)					
	Grounding		Negative					
	Current drain	Receive mode with no input signal		0.6A				
		HI transmit mode		Approx. 6.5A	Approx. 16A	Approx. 9.5A		Approx. 6.5A
		LOW transmit mode		Approx. 2.5A	Approx. 4A	Approx. 3A		Approx. 2.5A
	Operating temperature		-20°C to +50°C (-4°F to +122°F)					
	Dimensions (Projection not included)	Wide		180 mm				
High			60 mm					
Deep			195 mm	250 mm	215 mm		195 mm	
Weight			1.8 kg (4 lbs)	2.35 kg (5.2 lbs)	1.95 kg (4.3 lbs)		1.8 kg (4 lbs)	
			25 W min.	70 W min.	45 W min.		25 W min.	
Transmitter	Output power (at 13.8 VDC, 50 ohms load)	HI	25 W min.		70 W min.		45 W min.	
		LOW	5 W approx.					
			Adjustable up to out 20 W	Adjustable up to out 60 W	Adjustable up to out 40 W		Adjustable up to out 20 W	
		Note: Recommended duty cycle	1 minute : Transmission 3 minutes: Reception					
	Modulation		Reactance					
	Frequency stability		Less than ±15 PPM					
	Spurious radiation		Less than -60 dB					
Maximum frequency deviation		±5 kHz						
Audio distortion (at 60% modulation)		Less than 3% (300 Hz to 3000 Hz)						
Receiver	Circuitry		Double conversion superheterodyne					
	Intermediate frequency	1st	20.935 MHz	10.695 MHz				
		2nd	455 kHz					
	Sensitivity	12 dB SINAD	Less than 0.25 μV					
		S + N/N	More than 50 dB at 1 mV input					
	Selectivity	-6 dB	More than 12 kHz					
		-60 dB	Less than 24 kHz					
	Spurious response		Better than 70 dB (except fd-IF/2)					
	Squelch sensitivity		Less than 0.125 μV (threshold)					
	Scan stop level		Less than 0.2 μV (threshold)					
Output		More than 1.5 W across 8 ohms load (5% distortion)						
External speaker impedance		8 ohms						
DCL control	Code		NRZ equal-length code					
	Modulation		MSK modulation					
	Frequency deviation		±3.5 kHz reference					
	Mark frequency and deviation		1200 Hz, ±200 PPM					
	Space frequency and deviation		1800 Hz, ±200 PPM					
Code transmission speed and deviation		1200 bits/second, ±200 PPM						

Note: Circuit and ratings are subject to change without notice due to development in technology.

2-2. ACCESSORIES

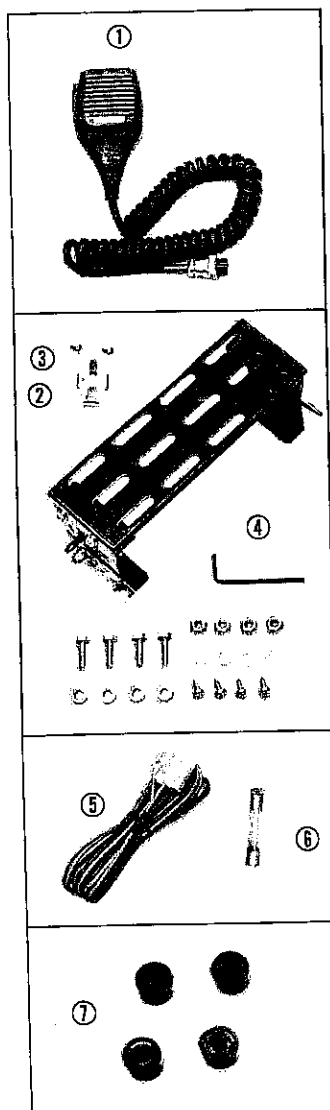

Unpack your TM-3530A/2570A/2550A/2550E/2530A carefully and confirm that it is supplied with the following accessories.

- | | | |
|---|---------------------|--------|
| ① Dynamic microphone | (T91-0357-05) | 1 pc. |
| Dynamic microphone (England only)..... | (T91-0335-05) | 1 pc. |
| ② Hook | (J19-1346-04) | 1 pc. |
| ③ Tapping screw | (N87-4008-41) | 2 pcs. |
| ④ Mobile mounting kit | | |
| a. Bracket | (A13-0668-04) | 1 pc. |
| b. Bracket assy (Right) | (A13-0666-02) | 1 pc. |
| c. Bracket assy (Left) | (A13-0667-02) | 1 pc. |
| d. Cushion | (G13-0823-04) | 4 pcs. |
| e. Allen bolt (Black) | (N99-0304-04) | 4 pcs. |
| f. Hex socket screw | (N09-0008-04) | 4 pcs. |
| g. Flange nut | (N14-0510-04) | 4 pcs. |
| h. Flat washer (Black) | (N15-1040-45) | 4 pcs. |
| i. Flat washer | (N15-1060-46) | 4 pcs. |
| j. Spring washer | (N16-0060-46) | 4 pcs. |
| k. Tapping screw | (N09-0632-05) | 4 pcs. |
| l. Hex wrench | (W01-0401-05) | 1 pc. |
| ⑤ DC power cable for TM-2570A | (E30-2044-05) | 1 pc. |
| DC power cable for TM-3530A/2550A/
2550E/2530A | (E30-2022-15) | 1 pc. |
| ⑥ Spare fuse for TM-2570A (20A) | (F05-2034-05) | 1 pc. |
| Spare fuse for TM-2550A/2550E (10A) | (F05-1031-05) | 1 pc. |
| Spare fuse for TM-3530A/2530A (8A) | (F05-8021-05) | 1 pc. |
| ⑦ Foot | (J02-0439-05) | 4 pcs. |
| Instruction manual (Excluded in England)..... | (B50-8039-20) | 1 copy |
| Instruction manual (England only) | (B50-8040-00) | 1 copy |
| Warranty card (U.S.A. only) | (B46-0410-00) | 1 copy |

Shipping container:

Save the boxes and packing in the event your unit needs to be transported for remote operation, maintenance, or service.

3. INSTALLATION AND CONNECTION

3-1. INSTALLATION

3-1-1. Precautions

1. Avoid direct sunlight, and select a dry, well ventilated location.
2. Since the heat sink is on the rear panel, avoid placing the equipment with the bottom and rear sides close to a wall or desk.
3. When installing the equipment in an automobile, ensure adequate ventilation. Install the equipment in a location where the rear does not make direct contact with the seat, and is not directly exposed to vibration.
4. Avoid installing the equipment in front of the car heater air outlet.

3-1-2. Power supply

The standard operating voltage of transceiver is 13.8 V. Do not use a power supply (both fixed and mobile) that provides over 16 V with the power switch of transceiver turned off.

Operation under such a condition will void the warranty. Also, do not use a power supply that does not supply at least 12V in transmit or receive. Use of such a supply may cause the performance of the equipment to suffer.

3-1-3. Mounting bracket

Using the supplied mounting bracket, install the transceiver in any convenient location. (Fig. 3-1)

Caution:

Do not install the speaker directly on the transceiver, it may cause howling. The heat sink provided at the rear of the transceiver will get hot during long transmission. Do not install the radio in a position where the heat sink may come in direct contact with the dashboard. Installation near heater air outlets should also be avoided.

If your car is equipped with an electronic fuel injection system, the transceiver should be mounted as far from the control equipment as possible.

Install the bracket as shown in Fig. 3-2 and Fig. 3-3.

Note:

Do not install backwards.

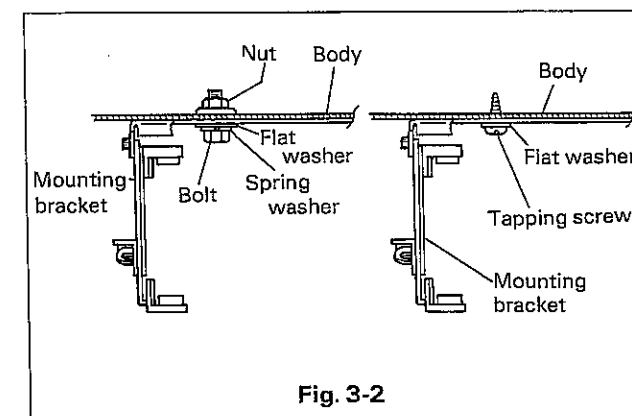

Fig. 3-2

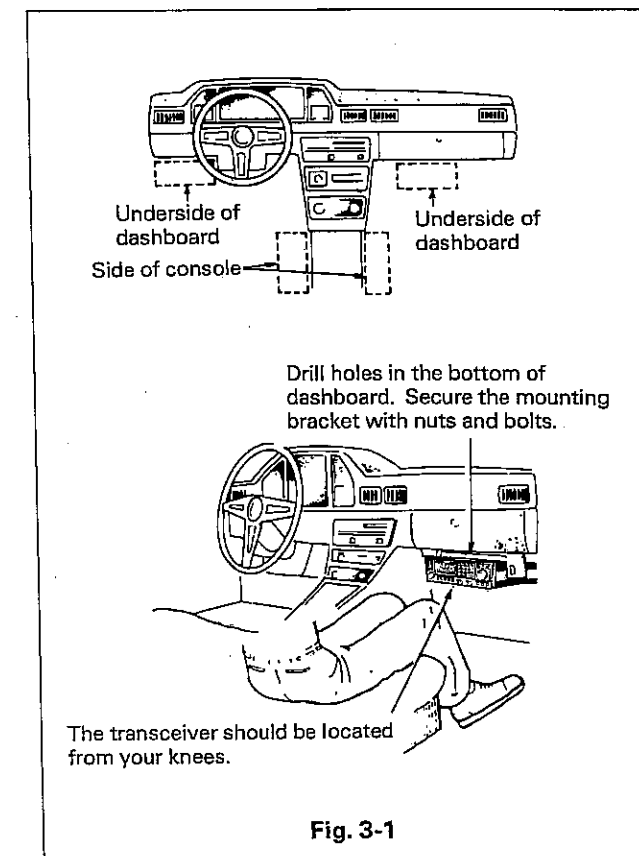

Fig. 3-1

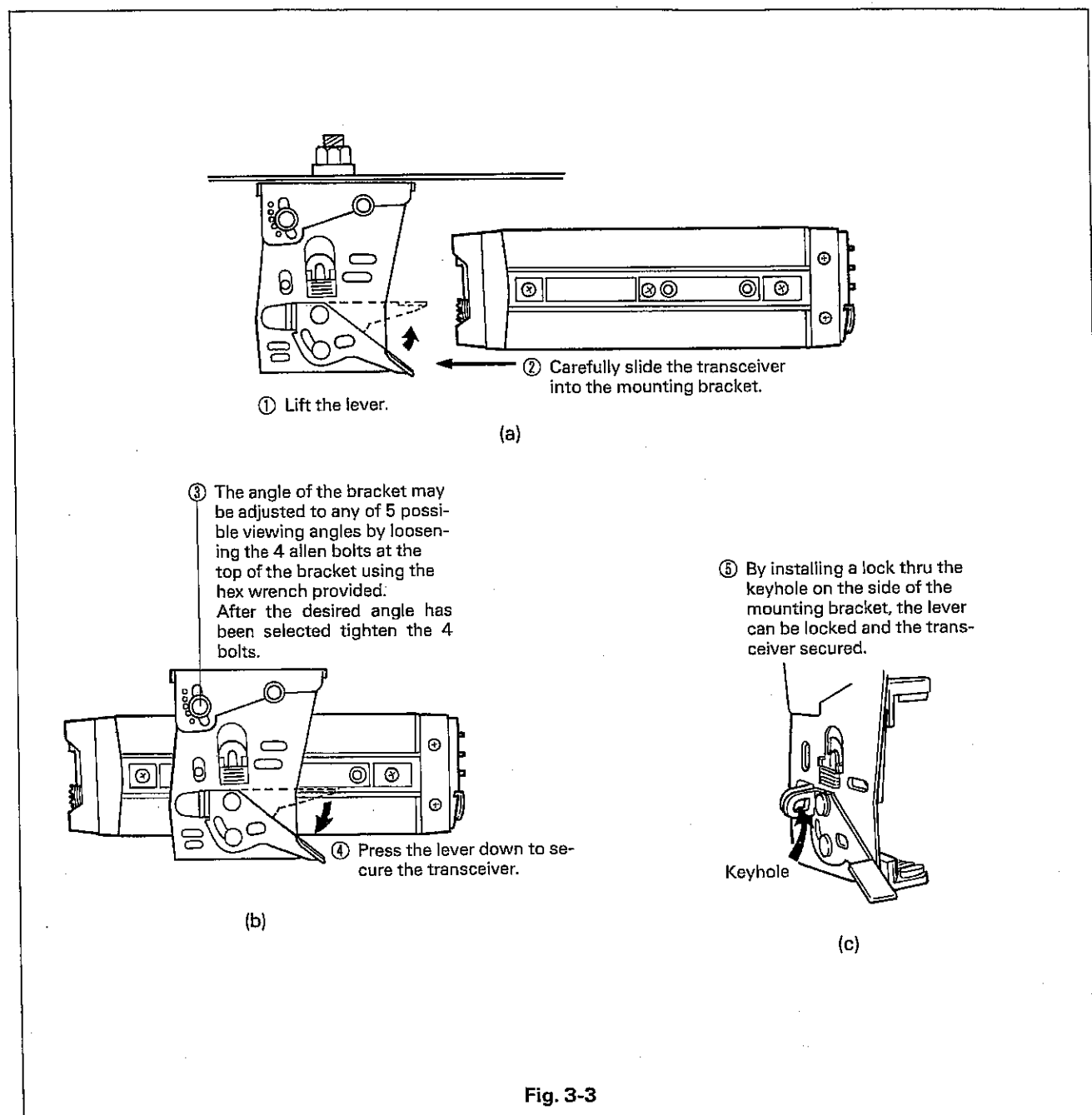

Fig. 3-3

3-2. CONNECTION

3-2-1. Precautions

1. When connecting or disconnecting the power cable to or from the power connector, be sure to turn off the POWER switches of the transceiver and the DC power supply.
2. Observe polarity of the cable. The transceiver operates on 13.8 VDC, negative ground. Battery polarity must be correct. The power cable is color coded:
3. The standard operating voltage of the equipment is 13.8V. Do not operate below 12V or over 16V.
4. When charging your vehicle battery, or when jump-starting a dead battery, ALWAYS disconnect the power cable from the back of the transceiver, or damage may result to the transceiver.

Red and white : ⊕ polarity (Positive)
 Black and gray : ⊖ polarity (Negative)

3-2-2. Fixed station

A regulated DC power supply (13.8 VDC) is required. The PS-430 is recommended for TM-3530A/2550A/2550E/2530A. The PS-50 is recommended for the TM-2570A.

A. PS-50/430 connection

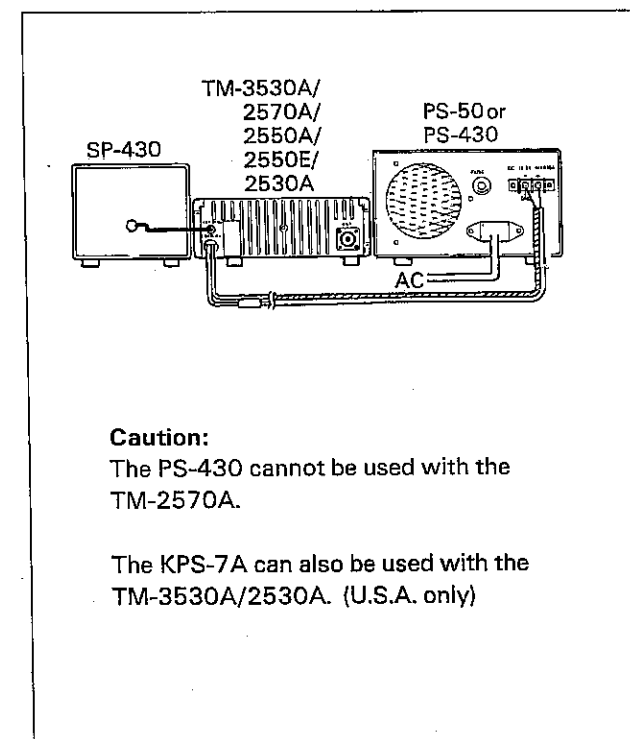

B. Connection of another DC source.

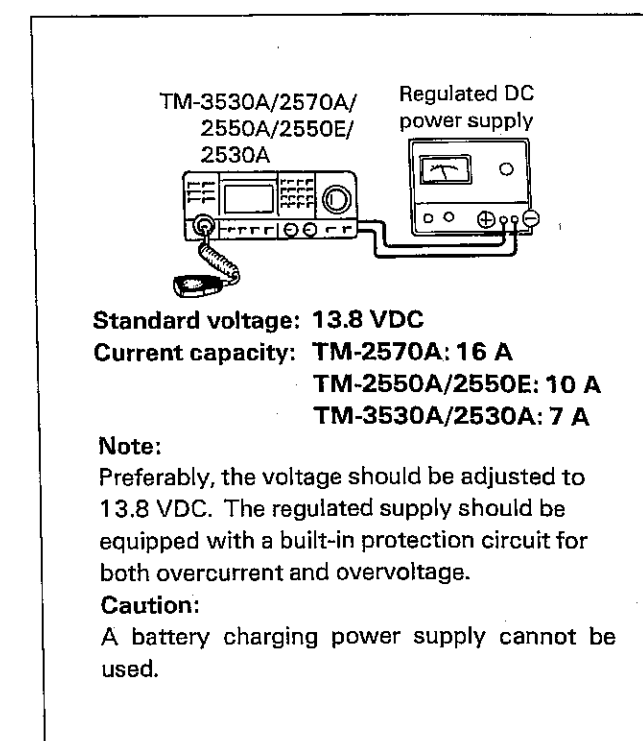

3-2-3. Mobile

A. Battery

Connect the power cable with fuse directly to the battery terminals. Connecting to the cigarette lighter socket can

cause a poor connection, and excessive voltage drop.

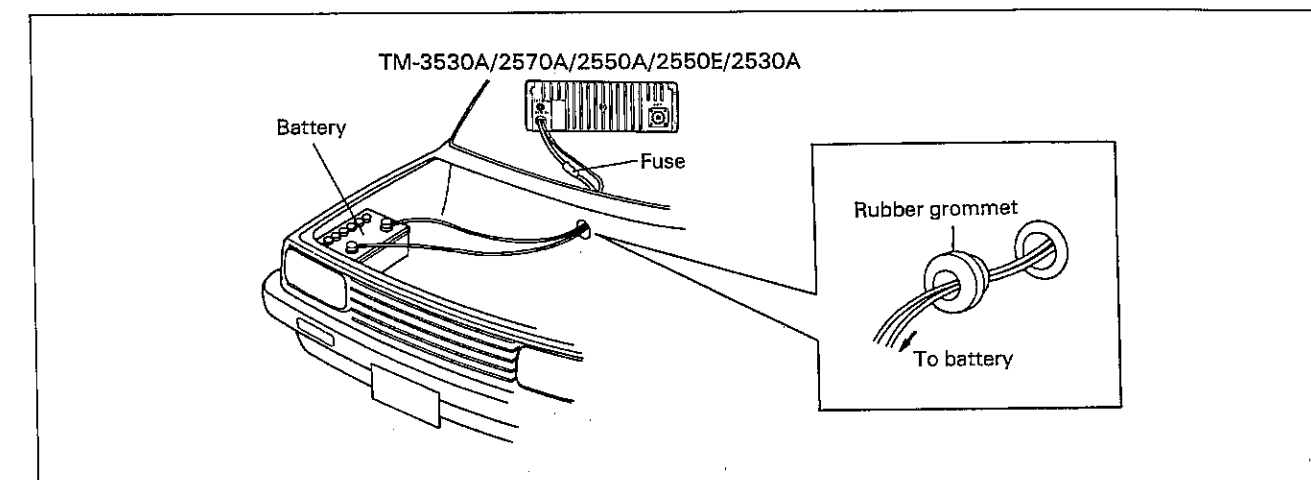

B. Ignition noise

This transceiver is designed to suppress ignition noise; however, if excessive noise is present, it may be necessary to use suppressor spark plugs (with resistors). The PG-3A DC line noise filter is available as an optional accessory for additional filtering, if required. (Except TM-2570A)

3-2-4. Antenna

Note that the SWR of your antenna should be less than 1.5. A high SWR will cause the TM-3530A/2570A/2550A/2550E/2530A protective circuit to operate, reducing the transmit output power.

4. OPERATION

4-1. CONTROLS AND THEIR FUNCTIONS

4-1-1. Front panel

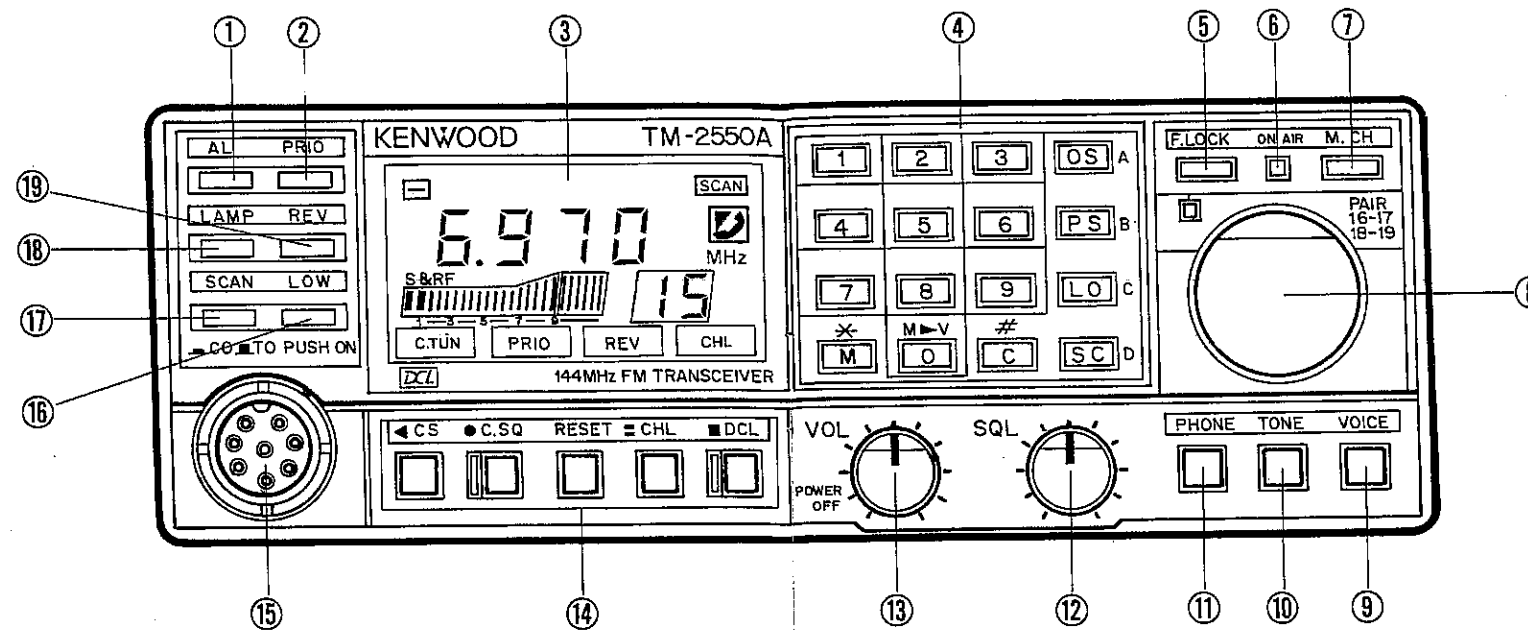

① AL (Alert) switch

This switch is used to check the specified priority channel. Depress the switch and the priority channel will be checked at about 6 second intervals regardless of the KEY/M.CH switch position. A "dual beep" sounds when the priority channel is in use.

② PRIO (Priority) switch

This switch is used to recall the priority channel. By depressing the switch, the operating frequency is switched to the priority channel, and the PRIO indicator lights.

③ LCD Group

See page 12.

④ Keyboard

See page 13.

⑤ F.LOCK (Frequency Lock) switch

Pressing this switch locks the selected frequency. The LED indicator lights when this switch is ON, as a visual reminder.

⑥ ON AIR indicator

This LED (Light Emitting Diode) will light during transmission.

⑦ M.CH (Memory Channel) switch

This switch is used to select either key mode (keyboard operation) or memory mode (memory channel operation). The MEMORY CHANNEL selector is illuminated in the memory mode.

⑧ MEMORY CHANNEL and TONE FREQUENCY selector

This switch is used to select the desired memory

channel. There are 23 memory channels. CH 1 to 19, CH A (A), CH b (B), CH d (D) and CH U (U). [This control is also used to select one of the 38 tone frequencies or one of the 15 telephone numbers. (TM-3530A/2570A/2550A/2530A only)]

⑨ VOICE switch

Pressing the switch actuates the VS-1 voice synthesizer unit.

⑩ TONE switch

(With the TM-3530A/2570A/2550A/2530A)
This switch is used to select the desired tone frequency. Any one of which can be 38 different frequencies between 67.0 Hz and 250.3 Hz are available. See page 20 for additional information on this switch. (Optional tone unit TU-7 required.)

(With the TM-2550E)

When this switch is pressed, the repeater control tone signal (1750 Hz) circuit is activated and the unit is set in the transmit mode.

⑪ (With the TM-3530A/2570A/2550A/2530A)

PHONE switch

Press this switch to select the telephone address number and program or recall the desired telephone number.

See page 21 for further information on this function.

(With the TM-2550E)

P. MR (Paired memory channel direct recall) switch

This switch is used for direct recall of paired memory channels (16 CH).

⑫ SQL (Squelch) control

To eliminate receiver noise during no-signal period, slowly adjust the SQL control clockwise until the noise disappears and the C.TUN indicator goes off (threshold point).

When a signal is received, the squelch will open, the C.TUN indicator will light and the speaker will operate. If the signal is weak or fades during mobile operation, readjust the squelch for constant reception. For scan operation, this control must be set to the threshold point.

⑬ POWER/VOL control

Power ON/OFF switch and volume control are combined. Turning the control fully counterclockwise will turn the power OFF. Clockwise rotation will increase the audio output.

⑭ DCL system keyboard

See page 25.

⑮ MIC connector (8-pin)

For connection of the supplied microphone (and or MC-48 autopatch microphone).

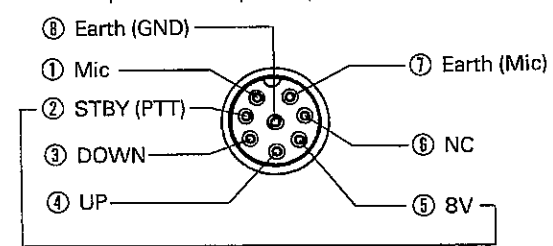

Caution:

The radio may be damaged if an external source voltage is applied to pins 2 - 5.

⑯ HIGH/LOW switch (HIGH LOW)

HIGH setting: This setting allows the TM-2570A to transmit up to 70 watts output, the TM-2550A/2550E up to 45 watts output and the TM-3530A/2530A up to 25 watts output.

LOW setting: This setting allows the TM-3530A/2570A/2550A/2550E/2530A to transmit up to approx. 5 watts output.

⑰ SCAN switch (TO CO)

When TO (Time Operated) scan has been selected the scan will stop on an occupied channel for a specific time frame (internally adjustable between 0 and 5 seconds). When CO (Carrier Operated) scan is selected the radio will remain on a station until the carrier drops out.

⑱ LAMP switch (ON)

This switch is used to illuminate the keys and switches.

⑲ REV switch

This switch is used to reverse the repeater shift (± 600 kHz for the 144 MHz band, ± 1.6 MHz for the 220 MHz band) and other transmit/receive frequencies (CH 16 - CH 17, CH 18 - CH 19).

1. LCD group

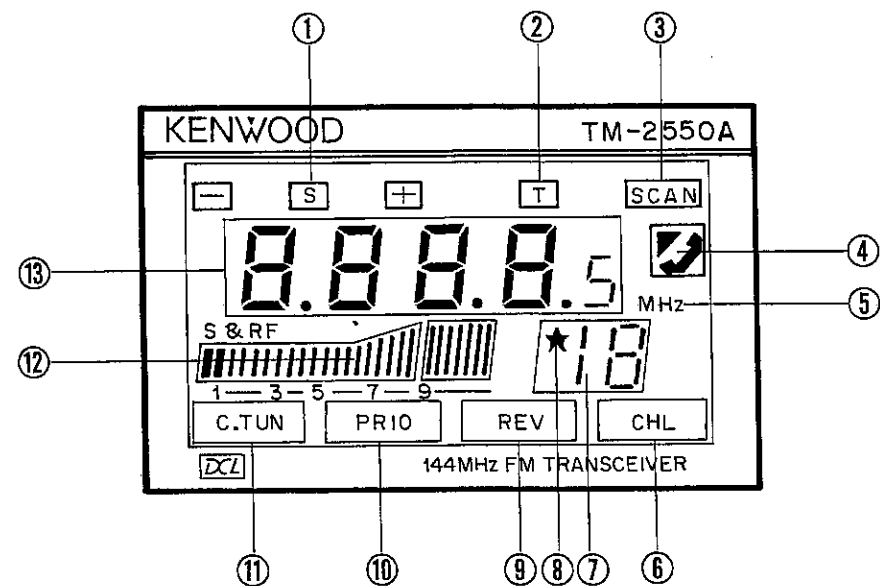

① TX offset indicators

- [-] By pressing the [OS] key on the keyboard, the [-] indicator will light in sequence to show the transmit frequency is switched down 600 kHz (1.6 MHz with the TM-3530A) from the receive frequency.
- [S] By pressing the [OS] key on the keyboard, the [S] indicator will light in sequence to show the transceiver is operating in the simplex mode.
- [+] By pressing the [OS] key on the keyboard, the [+] indicator will light in sequence to show the transmit frequency is switched up 600 kHz (1.6 MHz with the TM-3530A) from the receive frequency.

② T indicator

This lights when the tone function has been selected.

③ SCAN indicator

This indicator lights when scan operation is in progress.

④ TELEPHONE indicator

This indicator lights when the automatic telephone number transmission function has been selected. See page 21. (With TM-3530A/2570A/2550A/2530A only)

⑤ Hz indicator

"MHz" lights in the frequency display mode. [The display changes to "Hz" in the tone frequency display mode. (TM-3530A/2570A/2550A/2530A only)]

⑥ CHL (Channel Link) indicator

This indicator lights when the DCL (Digital Channel Link) has been completed.

⑦ Memory channel display indicator

These indicators display memory channels 1 to 19, A (A), b (b), d (d) or U (U).

⑧ ★ mark

Memory channel scan lock-out designator. If you desire to skip a busy memory channel during memory scan, press the [LO] key. The star designates the channel will be skipped during scan.

⑨ REV (Reverse) indicator

This indicator lights when the REV switch is ON.

⑩ PRIO (Priority) indicator

This indicator lights when the PRIO switch is ON.

⑪ C.TUN (Center Tuning) indicator

This indicator lights when the receiver has tuned in to another station.

⑫ S/RF level meter

This LED level meter indicates the relative receive input signal strength or transmit RF output. The level meter also indicates the microphone input level during low-power transmission so that microphone checking is possible.

⑬ Frequency, digital code, and call sign (ASCII code) information are displayed.

[The tone frequency, telephone channel number and telephone number are also displayed. (With TM-3530A/2570A/2550A/2530A only)]

2. Keyboard

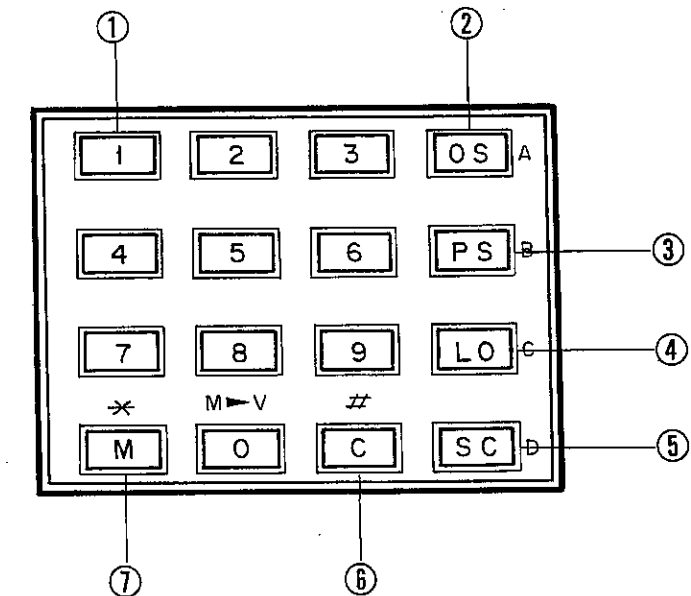

① Numeric keypad 1-0

Depress the [6], [9], [4] and [0] keys respectively. The frequency display will indicate "6.940" (146.940 MHz).

[The number keys function also serve as autopatch keys during transmit mode. (TM-3530A/2570A/2550A/2530A only)]

② [OS] (Offset Select) key

Depress this key to select a frequency shift other than the one recommended by the ARRL Band Plan (Simplex, +, or -, 600 kHz for the 144 MHz band and 1.6 MHz for the 220 MHz band) and the ITU Region 1 Band Plan (Simplex, -600 kHz for the 144 MHz band). (The standard ARRL and Region 1 Band Plan have been pre-programmed.)

③ [PS] (Priority Select) key

This key is used to designate the priority channel. First, select the desired channel, then depress the PRIO switch and finally press the [PS] key. The microprocessor is reset by turning the POWER switch ON while depressing this key.

④ [LO] (Lock-Out) key (Skip)

This key is used to designate the memory channel(s) to be skipped during memory scan. Select the channel to be skipped when the select switch is set to M.CH and then press this key. A star ★ appears on the LCD to show the channel has been locked-out.

⑤ [SC] (Scan) key

This key is used for scan operation. Press the key when the squelch is ON. Band-scan operation is executed while in the key mode and memory-scan operation is performed in the memory mode.

⑥ [C] (Clear) key

Use this key if you have made an error during programming. By pressing this key, the frequency set by the numeric keypad is cleared. When cleared, the frequency display will indicate the frequency that was displayed before the last entry was cleared. This key is also used to release scan operations.

⑦ [M] (Memory) key

This key is used to store frequency and offset. [This key is also used to store tone frequencies and telephone numbers in memory. (TM-3530A/2570A/2550A/2530A only)]

4-1-2. Rear panel

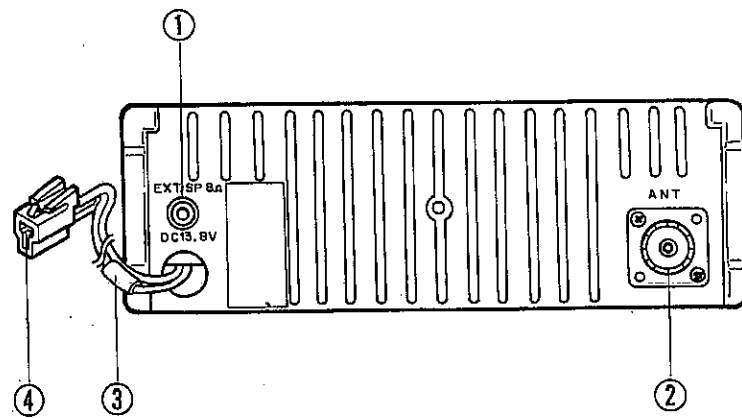

① **EXT SP (External Speaker) terminal**

Connect a 4 ~ 16 ohm speaker using the supplied plug.

② **ANT terminal**

Connect a 50-ohm antenna to this terminal.

③ **Fuse holder**

④ **DC power input terminal**

Connect the supplied power cable. Input voltage is 13.8 VDC. Do not reverse the polarity!

4-1-3. Microphone

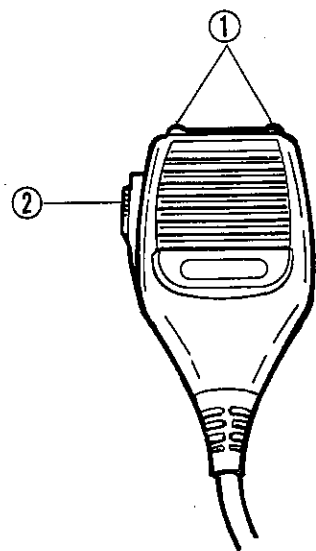

① **UP/DWN switches**

These switches are used to step the operating frequency up or down during both keyboard and memory channel operation.

② **PTT (Press-To-Talk) switch**

PTT switch used for transmission. This will also release scan operation.

4-2. RECEPTION

After power and antenna connections have been completed, set the controls and switches as follows:

- ① Turn the POWER/VOL control, clockwise, to turn on power. The indicators on the display will light to show the transceiver is operating.
The indicators normally work about 0.5 seconds after the power switch is turned on. [When the power switch is initially turned on, 4.000 (0.000 with the TM-3530A) will be displayed.]
- ② As the POWER/VOL control is turned clockwise, either background noise or a QSO will be heard.
- ③ To eliminate the no-signal noise, use the SQL control. For SQL control operation, refer to the following explanation.
- ④ Enter the desired frequency using the numeric keypad.

4-3. TRANSMISSION

4-3-1. Precautions:

- ① The TM-3530A/2570A/2550A/2550E/2530A antenna impedance is 50 ohms. Be sure to use only an antenna of 50 ohms impedance.
- ② Check the intended transmit frequency, before operating to prevent interference with other stations.
- ③ Pressing the PTT switch places the transceiver in transmit mode; the ON AIR indicator will light and the LED bar meter will show the relative transmitter power. Recommended talk distance to the microphone is approximately 5 cm.

To transmit, first select the desired frequency and see whether it is busy or not. If it is not busy, simply depress the PTT switch and speak into the microphone. The ON AIR indicator will light.

HI/LOW switch

Local QSO's can be enjoyed with less interference to others, and with less power consumption, by reducing the RF output power.

The relationship between the HI/LOW switch positions and the actual output power is as follows.

TM-2570A	HI	: 70W/approx. 16 A
	LOW	: Approx. 5W/approx. 3A
TM-2550A/2550E	HI	: 45 W/approx. 9.5 A
	LOW	: Approx. 5 W/approx. 3 A
TM-3530A/2530A	HI	: 25 W/approx. 6.5 A
	LOW	: Approx. 5 W/approx. 2.5 A

At LOW power, the power indication will drop to approximately "4 - 6" on the meter, and the microphone modulation check function operates.

4-4. MEMORY

4-4-1. Microprocessor memory back-up

A lithium battery is contained in the transceiver to retain memory. Turning off the POWER switch, disconnecting the power cable, or a power failure will not erase the memory. The battery should last for approximately five years. When the battery discharges, an erroneous display may appear in the display. (For the lithium battery replacement, refer to section 5-4 on page 33.)

play may appear in the display. (For the lithium battery replacement, refer to section 5-4 on page 33.)

Notes:

1. When the lithium battery is replaced, the microprocessor must be reset, using the procedure in section 4-4-2.
2. When the lithium battery fails, the radio's microcoded functions are NOT affected. Only information stored in memory will be cleared.

4-4-2. Initial state and reset of the microprocessor

A. Initial state of the microprocessor from the factory

Default setting after reset

Display

Frequency: 4.000 (144.000 MHz)
[0.000 (220.000 MHz) with the TM-3530A]

Offset: [S] (Simplex)

Memory channel: CH 1

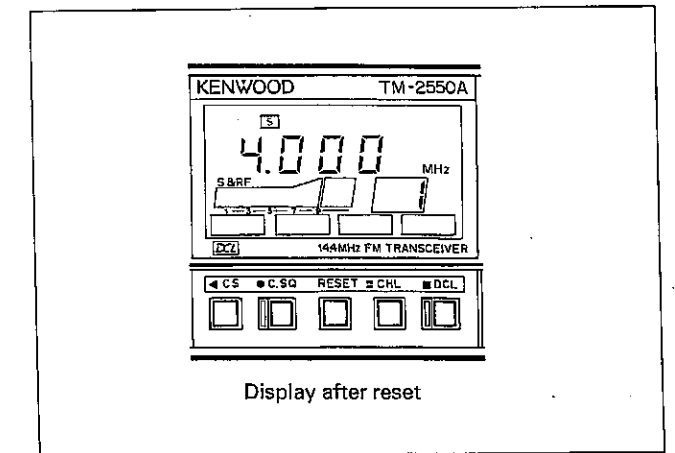

Display after reset

B. Microprocessor reset

When the microprocessor has functioned erroneously or when setting the transceiver in the initial state, switch on the power with the PS key pressed.

Note:

The microprocessor can be easily reset. However, only perform this operation when necessary since the contents of memory are cleared by resetting.

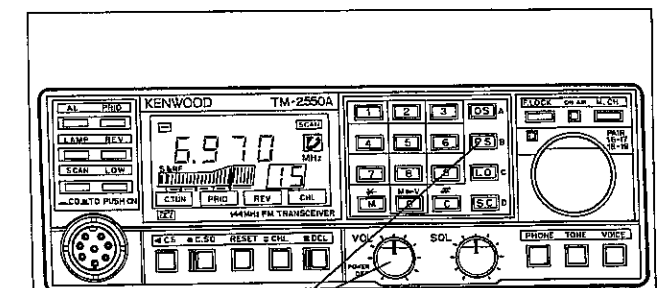

Turn POWER switch ON while depressing the [PS] key.

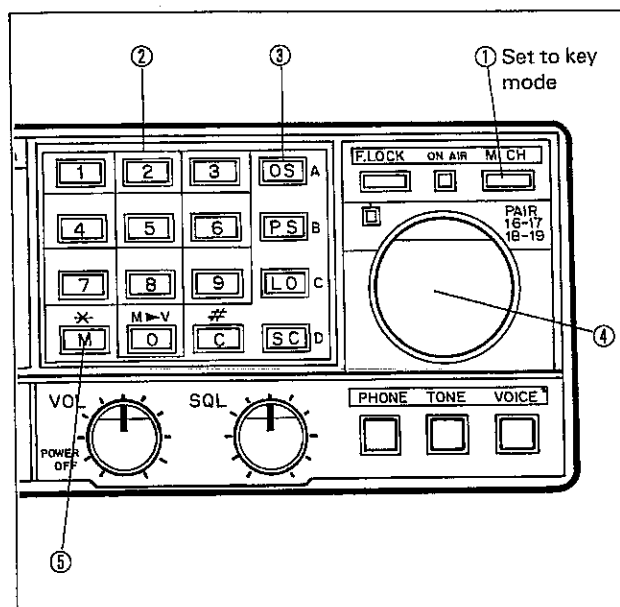

4-4-3. Memory input

(The same procedure is used with the TM-3530A.)

Example: Storing 144.650 MHz with +600 kHz offset in memory CH 5.

- ① Set the M.CH switch to key mode. (The MEMORY CHANNEL selector will not be illuminated.)
- ② Press the [4], [6], [5] and [0] keys in order. ("0" will be automatically selected as the last digit when you enter 0 ~ 4, as the last digit. "5" will be selected when you enter 5 ~ 9 as the last digit.)
- ③ Press the [OS] key to select an offset other than the standard offset for that frequency. You can scroll thru the different possibility by repeatedly pressing the key. If you want the standard offset skip this step.
- ④ Rotate the MEMORY CHANNEL selector until memory CH5 appears in the memory channel indicator.
- ⑤ Press the [M] key to enter the information into memory.

To confirm memory channel entry press the M.CH key. The MEMORY CHANNEL selector will be illuminated. The LCD should show the frequency and offset that you just entered, 4.650 "+". If the display does not show the correct data, simply repeat steps 1 thru 5.

If you wish to store new data into a memory channel simply repeat steps 1 thru 5 for the desired memory channel. Old data will be lost when you press the [M] key.

4-4-4. Paired channels

Two paired channels allow for "odd split" frequency shifts. Use this option when the desired frequency shift is other than the standard 600 kHz (1.6 MHz with the TM-3530A) shift. Any split within the full operating range of the radio is possible.

Channel pairs are: CH's 16 - 17 and CH's 18 - 19

Example: A 1 MHz split stores 144.600 MHz in CH 16 and 145.600 MHz in CH 17.

- ① Follow the "MEMORY INPUT" procedure on page 17 to store these frequencies in channels 16 and 17. Either frequency (receive or transmit) may be stored in either channel of the pair.
- ② To operate this channel pair, set the M.CH switch to memory mode and select either CH 16 or CH 17 with the MEMORY CHANNEL selector.
- ③ Transmit, and the displayed frequency changes to the transmit frequency stored in the alternate channel of the pair.
- ④ Release the PTT switch, and the original receive frequency stored in CH 16 or CH 17 will display.

The other channel pair, CH 18 - 19, operates in the same way. When channel pairs are used, the 600 kHz (1.6 MHz with the TM-3530A) shift and mode indicators, [+], [-] and [S] do not function.

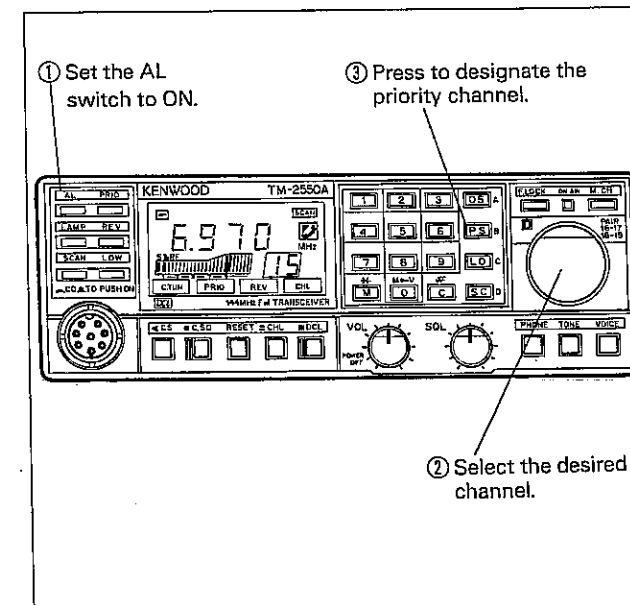

4-4-5. Priority channel select

Any one of the 23 memory channels can be selected as the priority channel.

- ① Depress the AL switch.
- ② Select the memory channel to be the priority channel using the MEMORY CHANNEL selector.
- ③ Press the [PS] key to enter the selection.

4-5. SCAN

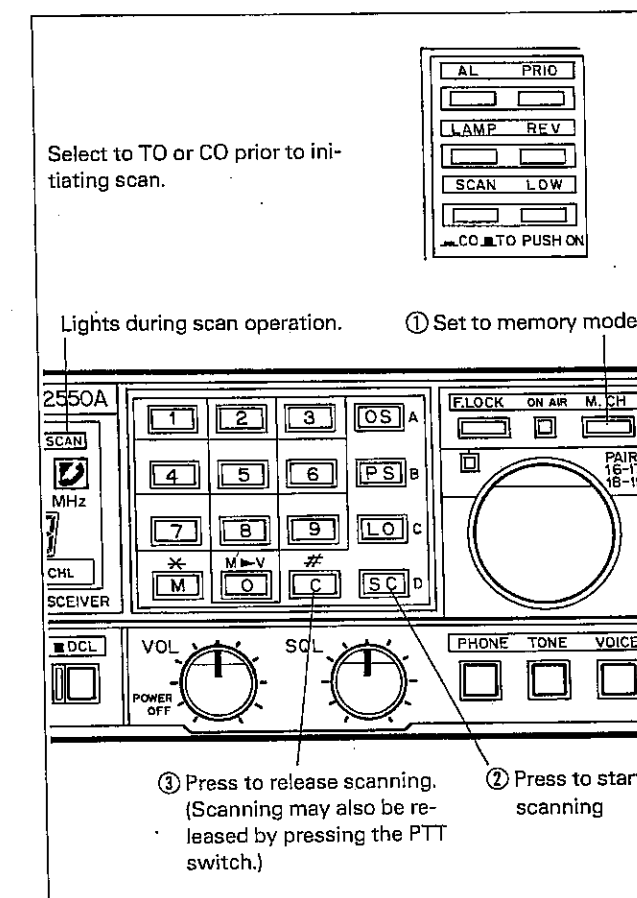

SCAN operations are divided into keyboard scan, memory scan and priority channel scan. For SCAN operation, the squelch control should be advanced to the threshold point. (See page 11 for squelch control.)

First, select either TO (Time Operated) hold or CO (Carrier Operated) hold with the SCAN switch.

The TO scan duration may be set thru the use of an internal potentiometer.

For details, see page 34.

4-5-1. Memory scan from the keyboard

- ① Press the M.CH switch to select memory mode. (The MEMORY CHANNEL selector will light.)
- ② Press the [SC] key to initiate scanning. Scan will begin from the current displayed channel advancing, toward the higher numbered channels.

RX	TX
CH 16	CH 17
CH 18	CH 19
or	
RX	TX
CH 17	CH 16
CH 19	CH 18

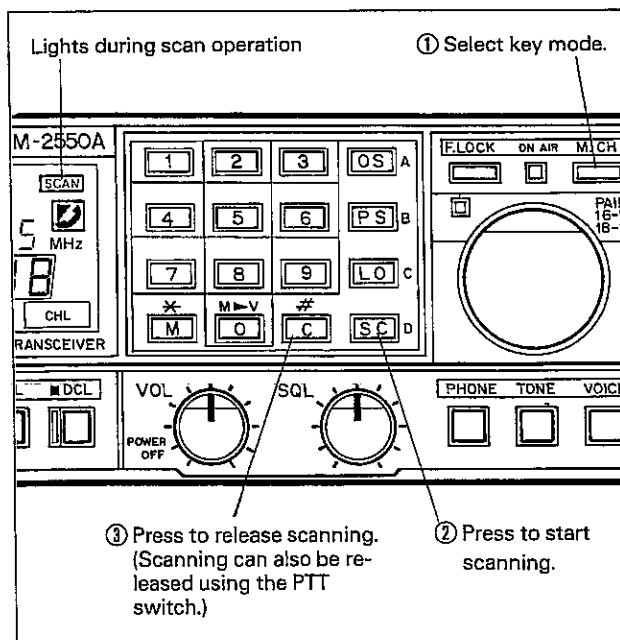

4-5-2. Programmable band-scan from the keyboard

The lower limit may be programmed into memory "d" and the upper limit into memory "U".

- Press the M.CH switch to select key mode. The MEMORY CHANNEL selector lamp will go OFF.
- Press the **[SC]** key to initiate scan operation. If scan is initiated within the limits set in channel "d" and "U", scan will proceed from the currently displayed frequency (within the programmed limits), in 5 kHz steps. If you initiate scan outside the programmed limits, scan will proceed outside the programmed limits, in 5 kHz steps.
- When the same frequency has been stored in both memory "d" and memory "U". The radio will scan the entire frequency range of the radio.

4-5-3. Scan direction

During scan operations you can reverse the direction of scan with the UP and DWN pushbuttons on the microphone. Pressing the DWN key causes scan to proceed down in frequency. Pressing the UP key causes scan to increase in frequency.

4-5-4. Scan speed

Scan speed can be increased by holding either the UP or the DWN key depressed, depending upon the desired direction of scan.

4-5-5. Scan lockout (Skip)

This transceiver has a scan lockout function which allows you to temporarily skip unwanted memory channels during memory scan.

- Press the M.CH switch to select the memory mode. (The MEMORY CHANNEL selector will light.)
- Select the memory channel to be skipped by using the MEMORY CHANNEL selector.
- Press the **[LO]** key and a star ★ appears to the left of the memory channel number.
- Repeat steps 2 and 3 to lockout any unwanted memory channels.

To cancel channel lockout, select the memory channel to be restored, and press the **[LO]** key. The star will disappear.

4-5-6. Scan release

Scanning can be released by any one of the following operations: Select the most convenient.

- Press the **[C]** key.
- Press the PTT switch once.
- Turn power OFF.
- Set the PRIO switch to ON.
- Set the F.LOCK switch to ON.

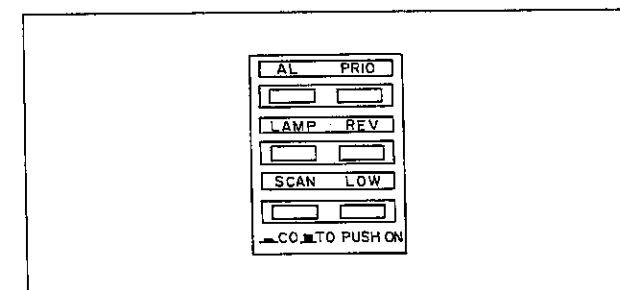

4-5-7. Priority channel scan (Alert)

To monitor the priority channel, press the AL switch in. When there is activity on the band you will hear two beeps at about six-second intervals. The REV switch deactivates this priority alert.

4-6. REPEATER

4-6-1. Automatic repeater offset

The standard ARRL and ITU Region 1 Band Plan, as far as TX offsets is concerned, has been pre-programmed into the TM-3530A/2570A/2550A/2550E/2530A. This

may be easily overridden by using the **[OS]** key. The chart below graphically displays the programmed offsets.

(With the TM-3530A)

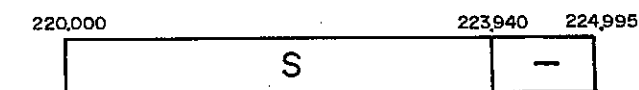

(With the TM-2570A/2550A/2530A)

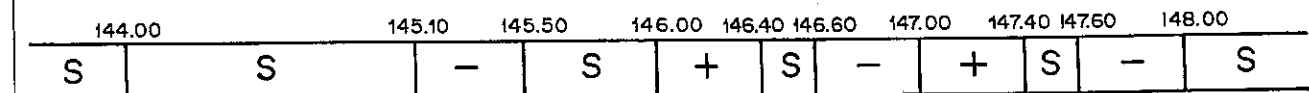

(With the TM-2550E)

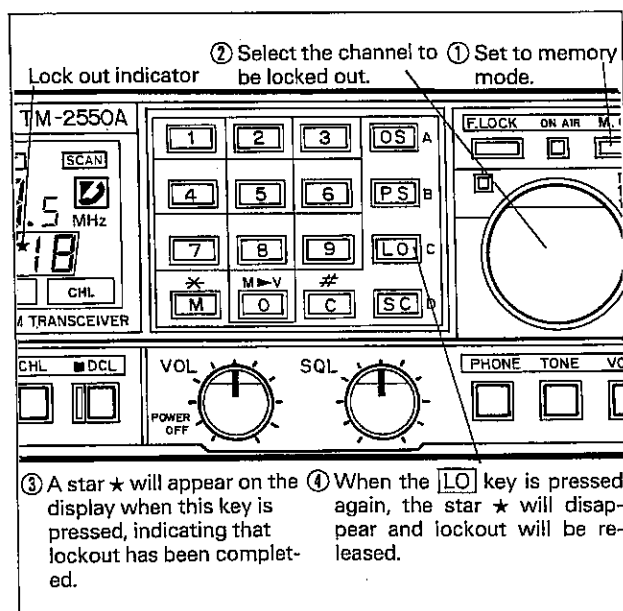
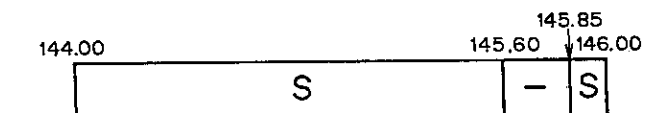

4-6-2. Tone frequency (TM-3530A/2570A/2550A/2530A only)

(The tone unit TU-7 option is required for this function.)

1. Setting

- ① Turn the MEMORY CHANNEL selector to select the desired memory channel.
(When in the key mode you may ignore this step.)
- ② Press the TONE switch. The display will indicate the CTCSS tone frequency, or " ---".
- ③ Turn the MEMORY CHANNEL selector to select a tone frequency from the 38 possible frequencies. The **T** indicator will light.
- ④ To store the tone frequency into a memory channel, press the **M** key.
- ⑤ Press the TONE switch to return to the frequency display mode. When transmission is begun in this mode, the tone frequency currently selected will be transmitted.

Example: To store tone frequency 88.5 Hz in memory CH 5

- ① Set the M.CH switch to memory mode (so that the MEMORY CHANNEL selector is illuminated) and turn the MEMORY CHANNEL selector to display "5" in the memory channel display indicator.
- ② Press the TONE switch.
- ③ Turn the MEMORY CHANNEL selector to display "88.5 Hz" in the tone frequency display. The **T** indicator will light.
- ④ Press the **M** key, to complete the storage of the tone frequency.
- ⑤ Press the TONE switch to return to normal frequency display mode.

2. Release

- ⑥ Instead of step ③ above, press the **C** key or rotate the MEMORY CHANNEL selector to display " ---". The **T** indicator will go OFF.
- ⑦ To release the tone frequency stored in memory, press the **C** key.

Available CTCSS tone frequencies

Hz	Hz	Hz
67.0	114.8	192.8
71.9	118.8	203.5
74.4	123.0	210.7
77.0	127.3	218.1
79.7	131.8	225.7
82.5	136.5	233.6
85.4	141.3	241.8
88.5	146.2	250.3
91.5	151.4	
94.8	156.7	
97.4	162.2	
100.0	167.9	
103.5	173.8	
107.2	179.9	
110.9	186.2	

4-7. AUTOMATIC TELEPHONE NUMBER TRANSMISSION SYSTEM (TM-3530A/2570A/2550A/2530A only)

This function simplifies conventional 16-key autopatch operation by utilizing a one-touch automatic dialing system. Up to 15 different 7-digit telephone numbers may be stored in memory. A separate channel is assigned to each telephone number, and all telephone number programming is performed in reference to this channel.

Example: Storing the telephone number (123-4567) in the telephone number CH 3.

4-7-1. Telephone number programming

- ① Press the PHONE switch
The display will show "A--" if no telephone data has been programmed, or the reset button has been installed. If data has been programmed the display will show the current telephone channel number.
- ② Rotate the MEMORY CHANNEL selector to select the desired telephone number channel. The telephone indicator **T** will light and the display will show "A 1 (thru A 15)".
- ③ Press the **PS** key.
The display will show the first three digits and a hyphen, or three blanks and a hyphen if no data has been entered. The memory channel display will now indicate the selected telephone number channel (1 - 15), rather than the normal memory channel numbers (1 - 19, A, B, C, U). A beep will sound each time you pass channel 1 as a quick audio check of your relative position. As you rotate the MEMORY CHANNEL selector the telephone channel number will change and the first three digits of the telephone numbers contained in the various channels will be displayed. If no data is entered the display will only show the hyphen.
- ④ Enter the first three digits of the telephone number using the numeric keypad. Input errors may be cleared by pressing the **C** key. After the third digit has been entered a beep will sound and the display will show 4 blanks, indicating the radio is waiting for you to enter the final four digits.
- ⑤ Use the numeric keypad to enter the final four digits. After the final digit has been entered a beep will sound, and the display will return to show the first three digits of the telephone number. You can review the contents of the entire telephone channel by repeatedly pressing the **PS** key.
(To enter a pause, or blank press the **SC** key.)

Entry of the remaining telephone channels is performed as in steps 4 and 5 above.

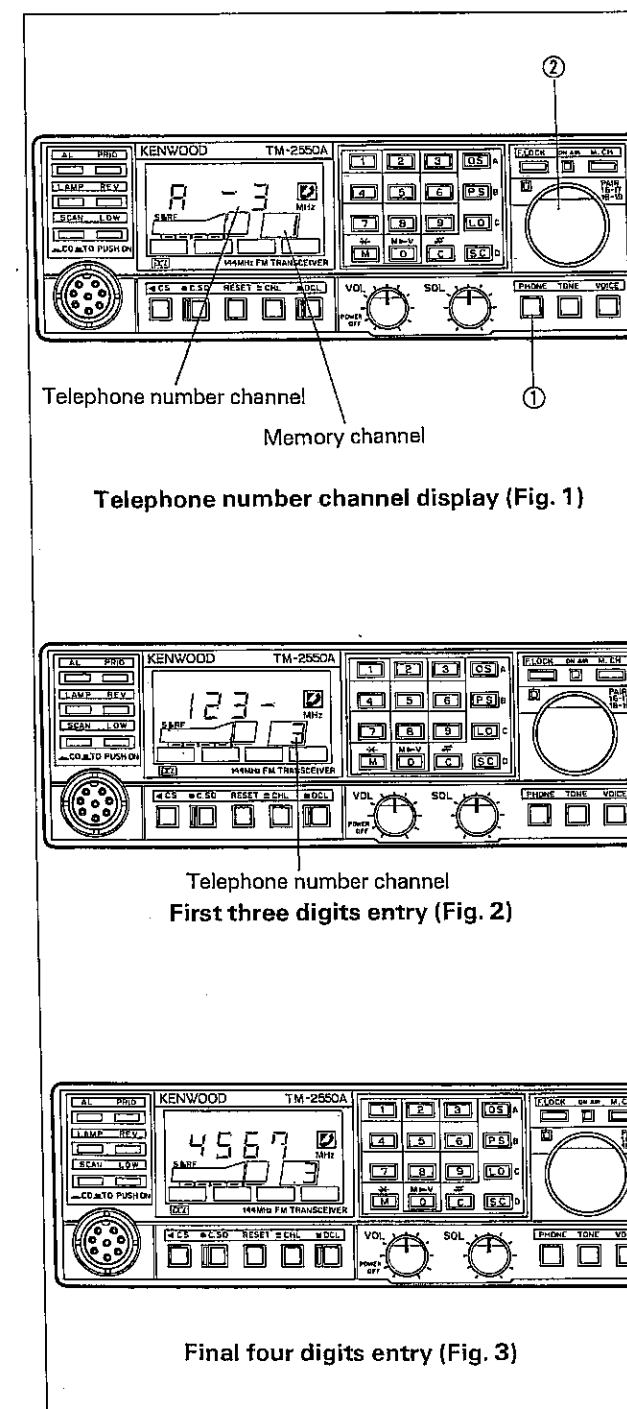
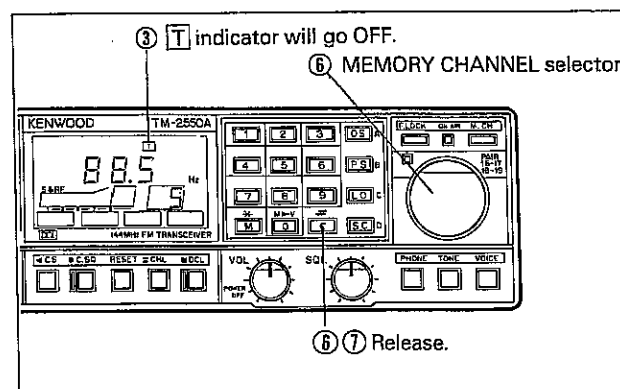
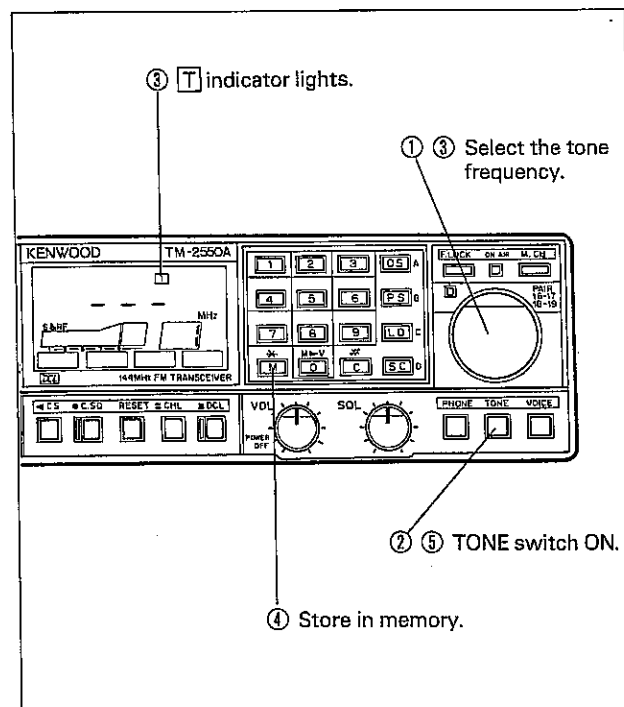

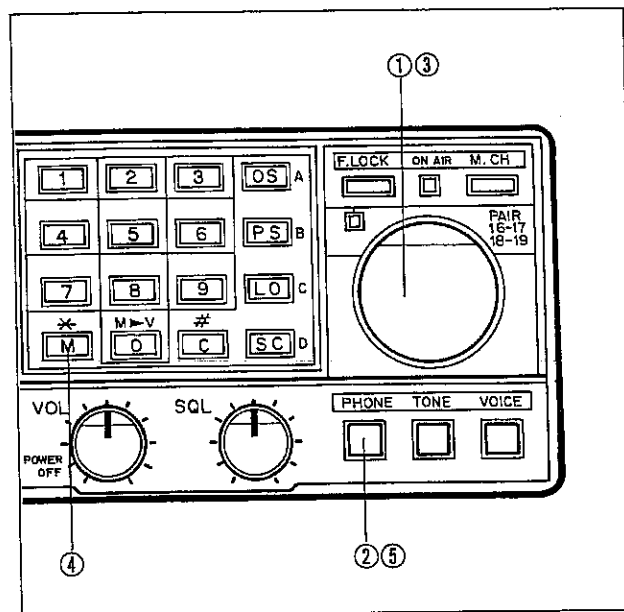

4-7-2. Storing a telephone channel in normal memory

- ① Select the desired memory channel with the MEMORY CHANNEL selector.
- ② Press the PHONE switch.
- ③ Select the desired telephone channel number with the MEMORY CHANNEL selector.
(When the [C] key is pressed, "F--" will be displayed, erasing any previously stored telephone channel number, and turning off the telephone indicator [M]. If you wish to review the contents of the telephone channel press the [PS] key as previously described.)
- ④ Press the [M] key.
(Pressing the [M] key stores the telephone channel information in the selected memory channel. Either the key mode or the memory mode may be used for this operation.)
- ⑤ Press the PHONE switch to return to the normal frequency display.

Any telephone number channel may be entered into any memory channel location using the above procedures.

4-7-3. Automatic telephone number transmission

- ① Select the desired telephone number channel using the MEMORY CHANNEL selector.
- ② Press the PTT switch.
- ③ Press the PHONE switch to initiate transmission of the telephone number.
(Pressing the PHONE switch with the telephone indicator off will cause an alarm to sound, signifying an error in operation.)

* Conventional 16-key autopatch operation is also possible, as is a combination of automatic dialing and conventional dialing. Simply press and hold the PTT bar when conventional operation is desired.

4-8. DCL (Digital Channel Link) SYSTEM

(The optional modem unit MU-1 is required for DCL system operation.)

- * Packed with a variety of new ideas, the DCL system makes possible multiple functions with simple operation.
- * The DCL system incorporates additional features but is compatible with the current DCS system.

4-8-1. DCL system description

A. Automatic QSY from any frequency to an open channel

The DCL system searches, on command, for an open channel, remembers it, returns to the original frequency and transmits control information to the receiving station that switches both radios to the open channel. Microprocessor control assures fast and reliable operation of the DCL system.

B. Operating principle of DCL system

The circuit concept of the DCL system is shown in the diagram. IC2 is the main processor which controls the DCL system's input/output processing and other general functions. IC3 is a processor concerned primarily with data processing, and Modem (modulator/demodulator) is the data transmission LSI using MSK (Minimum Shift Keying). As the digital data interface, the modulator section sends data required for transmission as a MSK signal synchronized with the clock. The demodulator section decodes the incoming MSK signal to obtain the data signal, and also reproduces the clock signal at the same time. Required data is exchanged between these ICs as is the clock data, so as to process various functions.

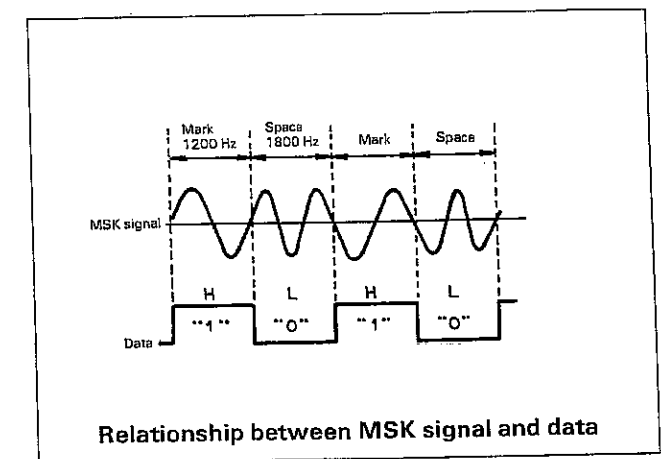
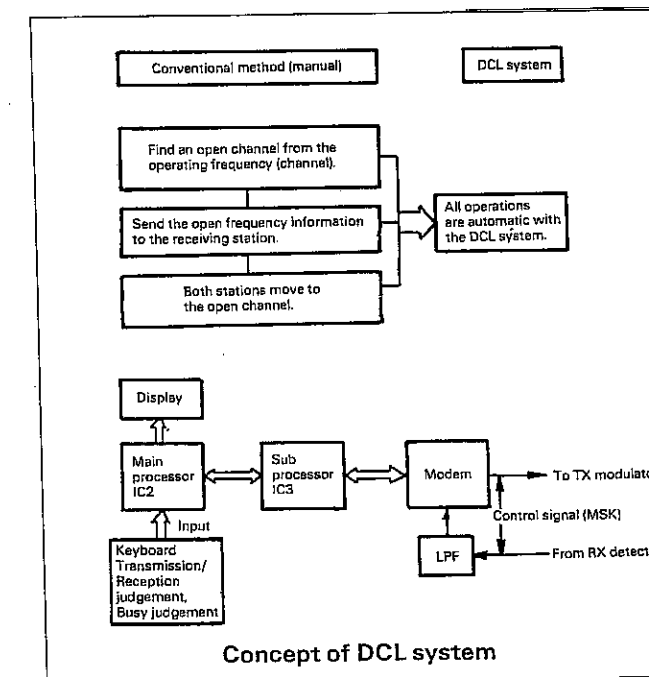

C. Digital code memory function for handling multiple stations, plus standby functions:

There are 100,000 5-digit code groups possible. Several different codes can be stored in memory.

D. Recall and reverse functions for preventing received station being lost:

When the DCL system of the station which has received digital signal is not ON, or when skipping to an open channel is not possible, due to interference or disturbance, instructions to the called station can be easily retransmitted.

E. Automatic transmission and display of call sign

Up to 6 characters can be input as the call sign. Although the input uses ASCII codes, 2-digit hexadecimal numbers are actually utilized for call sign entry. Each code is converted into an ASCII code inside the radio. Call sign data is transmitted as long as the DCL switch is ON. A unique feature of this system is that by combining it with the optional CD-10 call sign display, it can decode the signal from a station which uses the DCL system and display that call sign alphanumerically.

F. New code squelch function with repeater operation

Code squelch is a selective squelch system operated through the use of digital codes. It allows you to listen only for those stations that transmit the proper digital code. It is especially powerful when more than one station is on the frequency, like when using repeaters. Its advantages are; 1) Very few operation errors thanks to digital control; 2) Multiple access code monitoring; 3) Possibility of linkage to an open channel even during long periods of inactivity. When operating on a repeater, the control signal (as shown in the diagram) is transmitted to assure proper code squelch operation.

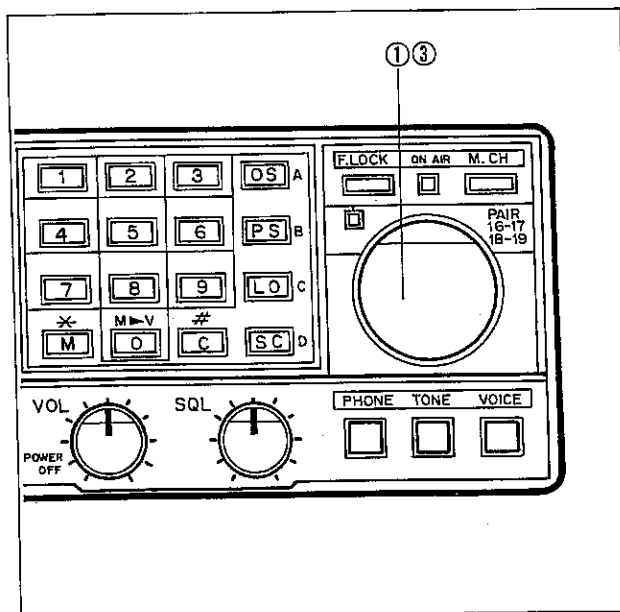

Control signals for CHL operation

Control signal:

 : The control signal with channel data

Beep: Beep 1

 : The control signal with no channel data

Beep 2

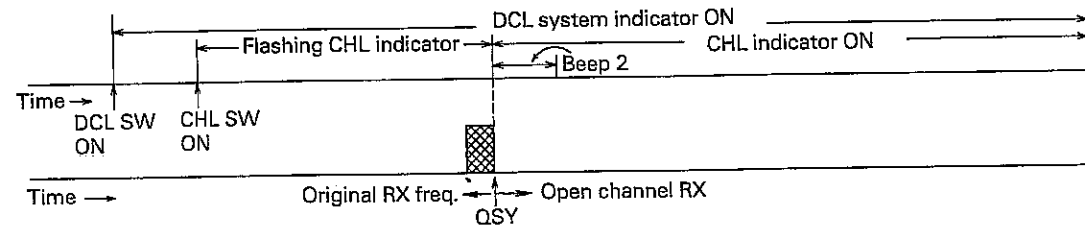

Fig. a. Simplex mode

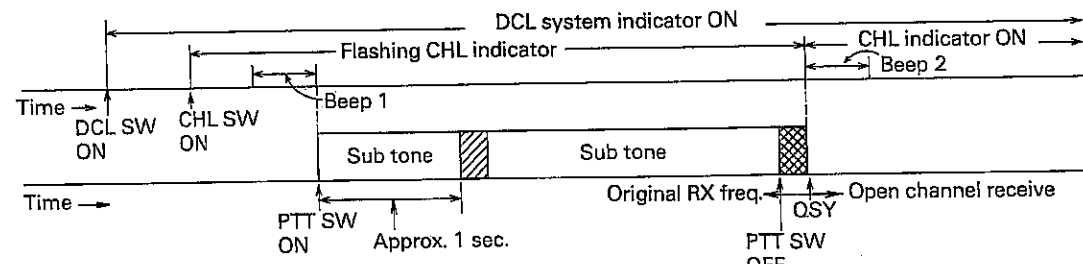

Fig. b. Offset mode (TM-3530A/2570A/2550A/2530A)

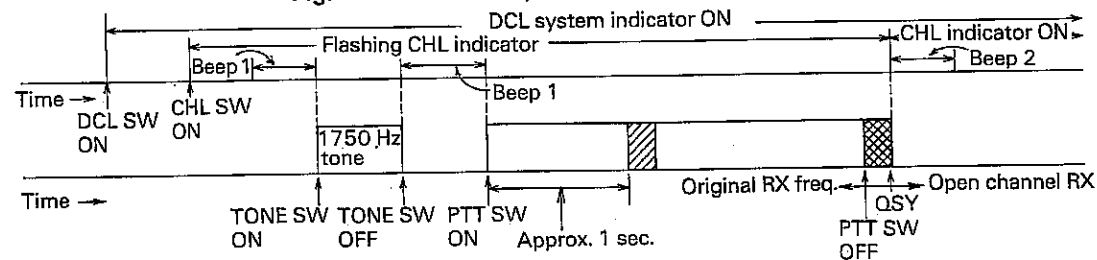



Fig. c. Offset mode (TM-2550E)

G. Control signal of DCL system

The DCL control signal consists of: 1) Bit/frame sync signal for distinction of the DCL signal from noise or other data communication signals; 2) 5-digit digital code data for station recognition; 3) Open channel data; and 4) Call sign data which is a combination of alphanumeric data. Auxiliary data is also provided for future system expansion. This control signal is transmitted at a speed of 1200 baud, requiring approx. 0.2 seconds, which has almost no effect on normal communication. A beep sound, peculiar to DCL, (similar to the sound of "packet radio") is heard when this signal is received.

DCL operation control signal

 The control signal with no channel data

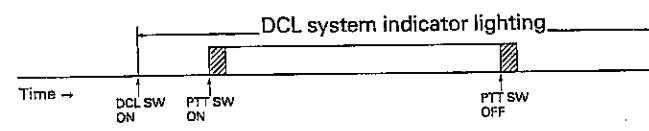

Fig. a. Simplex mode

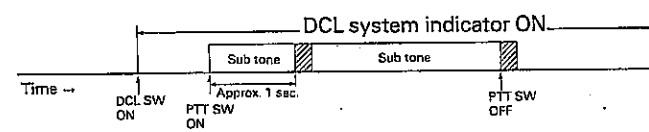

Fig. b. Offset mode (TM-3530A/2570A/2550A/2530A)

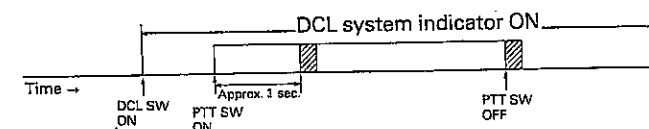
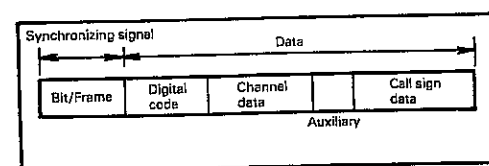
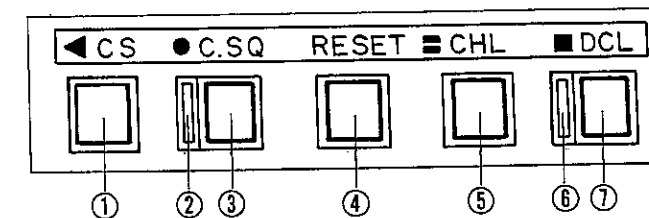

Fig. c. Offset mode (TM-2550E)



Composition of control signal

4-8-2. DCL system keyboard



① CS (Code Set) key

Use this key when programming the digital code and call sign.

② C.S.Q (Code Squelch) key

This lights when the C.S.Q function is ON.

③ C.S.Q (Code Squelch) key

Use this key to turn the code squelch function ON or OFF. The C.S.Q indicator lights when this function is activated.

④ RESET key

Use this key to reset channel linkage operation.

⑤ CHL (Channel Link) key

Use this key for channel linkage.

⑥ DCL system indicator

This lights when DCL is ON.

⑦ DCL (Digital Channel Link) key

Use this key to turn the DCL system ON or OFF. The DCL system indicator lights when this function is active.

4-8-3. Digital code entry

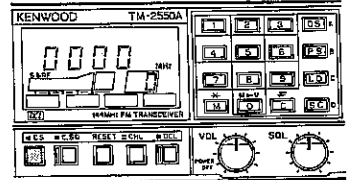
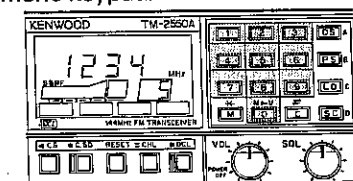
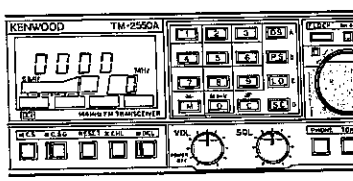
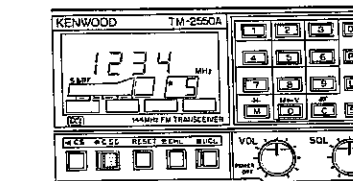
Operating procedure	Operation	Remarks
<p>1. Press the CS key to cause the digital access code to be displayed.</p> <p>("00000" is displayed initially.)</p> 	<p>Pressing the key once causes the digital access code to be displayed.</p> <p>(Pressing the key again will return you to the normal frequency display.)</p>	<p>The digital code cannot be programmed with the F.LOCK on.</p> <p>This function is independent of the DCL key setting.</p>
<p>2. Enter the digital code using the numeric keypad.</p> 	<p>The code is stored in memory automatically, when the final digit is entered, and is confirmed by long beep.</p>	<p>It is possible to receive while setting the codes but not to transmit.</p>
<p>3. Rotate the MEMORY CHANNEL selector to select the desired code position for data entry, or to review the contents of the other 9 code memories.</p> 	<p>Each time the MEMORY CHANNEL selector is rotated one detent position the code memory will increment/decrement one position. Continued rotation will allow continuous tuning of the code positions.</p>	<p>An audible beep is emitted from the radio each time the dial is rotated to code memory position one.</p>
<p>4. Press the C.S.Q key to activate the C.S.Q indicator.</p> 	<p>Pressing this key once lights the standby indicator. Pressing the key again will turn the indicator OFF.</p>	<p>This operation is valid only while the digital code is being displayed.</p>

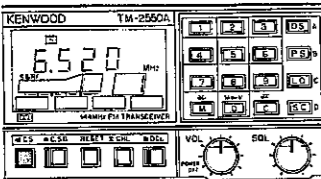
Operating procedure	Operation	Remarks
5. Press the CS key to return to the normal frequency display. 	After all inputs have been completed, press the CS key to return to the normal frequency display.	As long as you are displaying the digital codes you will not be able to transmit. Attempting to transmit will cause an error alarm of three beeps to sound.

Notes:

- The digital code that appears when the CS key is pressed is the code that will be transmitted, regardless of the standby status.
- The digital code that appears when the CS key is

pressed will also be one of the "Active" codes in receive, along with any other codes that have the standby indicator "ON".

4-8-4. Code squelch

This function gives the operator the ability to select which stations he/she wants to listen to. Only those stations that transmit the proper access code will be able to "OPEN" squelch.

For example: when station A wishes to talk with station

B only, both stations should prearrange to be on the same frequency, with the same access code.

Example: Frequency : 146.520 MHz
Digital code: 12345

The same procedure is used with the TM-3530A.

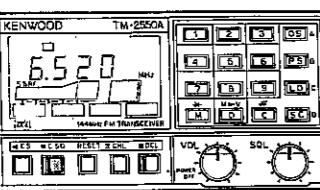
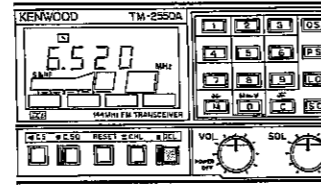
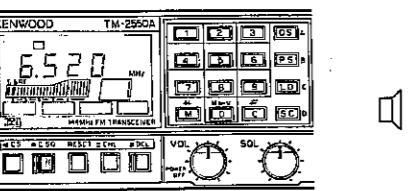
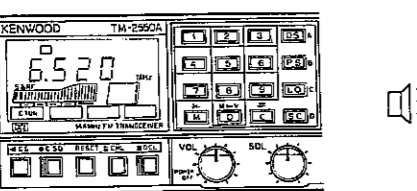
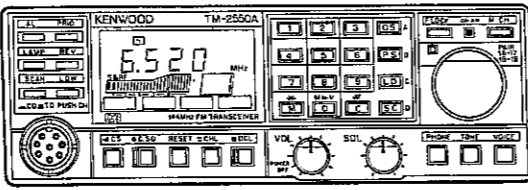
Station A	Station B
1. Press the C.SQ key. (C.SQ indicator will light and undesired signals will not break squelch.) 	1. Press the DCL key to turn on the DCL system. 
2. Signals of other stations (with different digital access codes, or no digital code) will not be heard, even though the S meter confirms their presence. 	
3. When station B transmits the proper access code, the C.SQ indicator will go out, and digital squelch will open. Three beeps will sound to signal reception of the desired code. 	3. Press the PTT switch to send the transmit code. (Code information is sent at the beginning and the end of each transmission.) 

- To manually release the code squelch, press the C.SQ key again or press the PTT switch. (This does not start transmission.)
- Channel linkage using the DCL system is effective even in code squelch mode.

With the DCL system ON (DCL key ON) in the code squelch condition (C.SQ key ON), turning the DCL key OFF will also release the code squelch function.

- The alert function has priority over code squelch operation.

4-8-5. Channel linkage

Channel linkage operations cannot be performed until you have completed entering at least one digital access code. This information is required for proper system operation. You do not need to use the code but it must

be present. The DCL function allow easy one touch QSY to the first available open channel, of not only your radio, but the receiving radio as well.

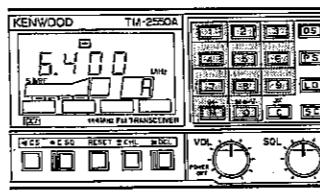
Operating procedure	Operation	Remarks
1. Enter the frequency that you want open channel searches to begin from into memory channel A. 	Memory entry is as discussed in previous sections. The digital channel search will search up to 11 channels from the frequency stored in memory channel A (a total of 12 channels). (With the TM-2570A/2550A/2550E/2530A) The step size is: 15 kHz (or 20 kHz by cutting internal diode) for the TM-2570A/2550A/2530A, and 25 kHz with the TM-2550E. Example: When 146.400 MHz is entered in CH A (TM-2570A/2550A/2530A) search proceeds as follows: 1. 146.400 2. 146.415 3. 146.430 : : : 12. 146.565 (With the TM-3530A) The step size is: 20 kHz (or 40 kHz by cutting internal diode) Example: When 223.540 MHz is entered in CH A search proceeds as follows: 1. 223.540 2. 223.560 3. 223.580 : : : 12. 223.760	If you have entered a frequency into memory channel "b", that is one of the frequencies that will be scanned by the channel search function, that frequency will not be selected as the open channel, even if it is vacant. Note: Open channel search will not stop on the original frequency under any circumstance.

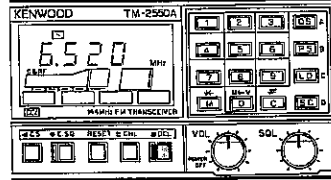
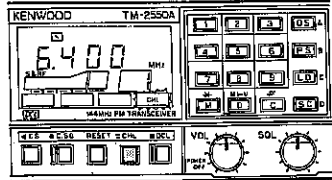
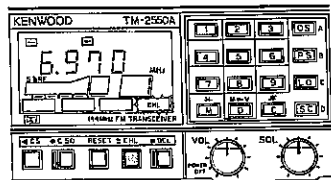
Operating procedure	Operation	Remarks
<p>2. Press the DCL key to switch the system ON.</p> 	<p>Pressing once turns the system ON and lights the DCL system indicator. (Pressing again switches the system OFF.)</p>	
<p>< When the offset is [S] (Simplex) ></p> <p>3. Press the CHL key to start channel linkage operation.</p> 	<p>When the key is pressed once, the LCD indicator flashes and the open channel range is scanned. (The frequency display also displays the open channel being scanned.) When an open channel is found, the original operating frequency is selected and data is automatically transmitted for movement to the open channel.</p> <p>If the C.SQ system of the receiving station is on, in conjunction with the DCL system, you must ensure that the transmit code is the same as his receive code for proper system operation. If the codes are the same the DCL system will operate normally, i.e. both radios will be switched to the open channel.</p>	<ol style="list-style-type: none"> 1. When an open channel is not found, press the PTT switch or RESET key to release the search. 2. If another station is transmitting on the original frequency when the unit returns from the open channel search, automatic transmission will not take place. The radio will enter a receive mode, in which a series of three beeps sounds repeatedly, while normal receive functions occur. As soon as the channel is open you can initiate the automatic frequency change by simply pressing the PTT switch.
<p>< When the offset is [+] or [-] ></p> <p>3. Press the CHL key to start channel linkage operation.</p> 	<p>When the key is pressed once, the LCD indicator flashes and the open channel range is scanned. (The frequency display also displays the open channel being scanned.)</p> <p>When an open channel is found, the original operating frequency is selected and the radio will enter a receive mode, in which a series of three beeps sounds repeatedly, while normal receive functions occur.</p> <p>As soon as the channel is open you can initiate the automatic frequency change by simply pressing and releasing the PTT switch. (TM-3530A/2570A/2550A/2530A only)</p> <p>The TONE switch must be on for proper operation. (TM-2550E only)</p>	<ol style="list-style-type: none"> 1. If an open channel is not found, press the PTT switch or RESET key to release DCL functions. 2. Channel linkage does not occur until the PTT switch is released. 3. Just as when operating in the simplex mode C.SQ system may also be used. However, some repeater systems may not pass the DCL signal properly. This is due to a time delay in the repeater, and is not a fault of the DCL system.

To move to an open channel during communication between stations A and B at 146.520 MHz, proceed as follows. (In this example, 146.520 MHz is the frequency of operation.)
The same procedure is used with the TM-3530A.

Example:

Initiating station : Station A
Waiting station : Station B
Digital code : 12345
Offset : [S] (Simplex)
Memory CH A : 146.400 MHz

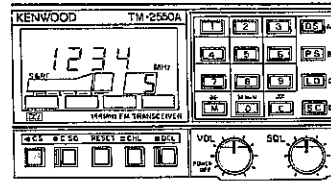
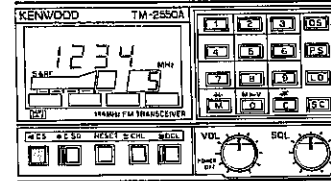
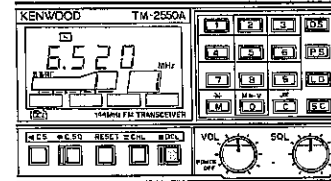
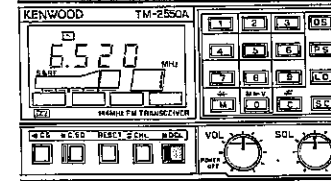
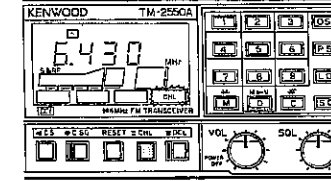
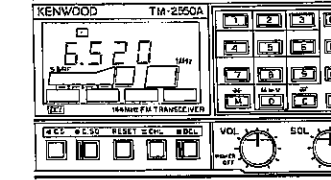
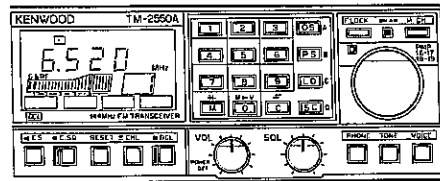
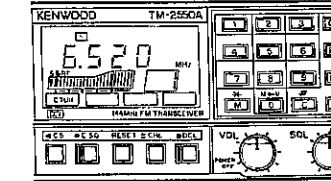
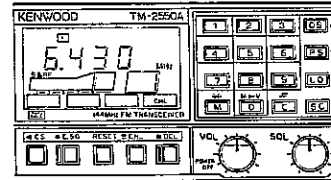
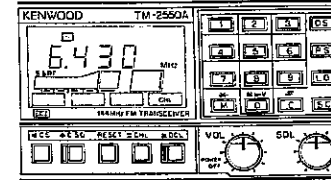
Station A	Station B
<p>1. Confirm the digital code. Press the CS key to check that the digital code is "12345", then press the CS key again.</p> 	<p>1. Confirm the digital code. Press the CS key to check that the digital code is "12345", then press the CS key again.</p> 
<p>2. Press the DCL key to switch the DCL system ON.</p> 	<p>2. Press the DCL key to switch the DCL system ON.</p> 
<p>3. Press the CHL key. The CHL indicator flashes and a search for an open channel begins. (This example assumes that there is an open channel at 146.430 MHz.)</p> 	<p>3. Standby.</p> 
<p>4. The original operating frequency (146.520 MHz) is selected and data is transmitted automatically.</p> 	<p>4. The transmit data of station A is received.</p> 
<p>5. The radio QSY's to the open channel. As the movement to the open channel (146.430 MHz) occurs, the flashing CHL indicator lights continuously and beep sound is generated to announce the completion of channel linkage.</p> 	<p>5. The radio QSY's to the open channel. As the movement to the open channel (146.430 MHz) occurs, the CHL indicator lights continuously and beep sound is generated to announce the completion of channel linkage.</p> 

4-8-6. Recall

The recall function is a channel re-linkage operation. If, in the previous example, the channel linkage could not be completed, station A would use the recall function to

again attempt to bring station B to the open channel (146.430 MHz). The same procedure is used with the TM-3530A.

Station A

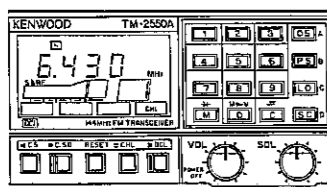

Station B

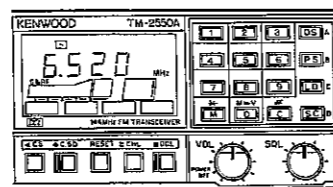

Recall procedure (Channel linkage completed on initiating station but not on receiving station)

Station A operation

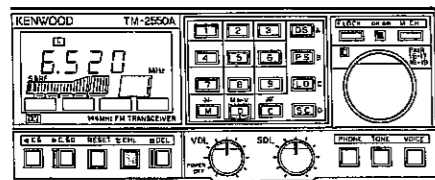

Press the CHL key again. Steps 4 and 5 of the previous section will be repeated. You may repeat this operation as many times as necessary, as long as the LCD indicator is ON.

4-8-7. Reset and return

A. Reset function:

Use this function to move to another open channel after completing a channel linkage. This function enables either station to initiate channel linkage by resetting the

CHL system. (This is confirmed by the fact that the CHL indicator is turned OFF.)

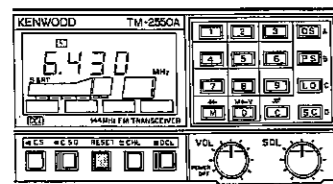
Operating procedure	Operation	Remarks
1. Press the RESET key. 	Pressing once turns the LCD indicator OFF and releases the channel linkage operation. Now, new channel linkage is possible.	

B. Return Function:

Use if automatic QSY fails on any station you are communicating with. For example: stations A and B are communicating with each other. Station A initiates the channel linkage function. However station B is not successful

in the linkage operation. Pressing the RESET key will return the radio to the original operating frequency with a simple one touch operation.

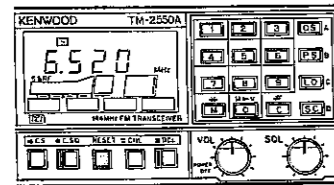
Operating procedure	Operation	Remarks
1. Press the RESET key. 	Pressing the key again after reset operation causes the original channel (146.520 MHz) to be displayed. Each time the key is subsequently depressed the display will switch between the original operating frequency (146.520 MHz) and the open channel frequency (146.430 MHz). Press the CHL key while the original operating frequency is displayed and channel linkage operation will be initiated again. The same procedure is used with the TM-3530A.	The original operating frequency and the open channel are stored into memory at the time the channel linkage operation is originally completed.

4-8-8. Call sign entry

The TM-3530A/2570A/2550A/2550E/2530A employs a method of displaying and entering the call sign digit by digit using decimal ASCII codes. Set the call sign by referring to the ASCII call sign data.

After the call sign has been entered, it will not be necessary to reenter it as long as you operate the TM-3530A/2570A/2550A/2550E/2530A.

(However, if the reset (page 15) is depressed or the lithium battery were to fail, reprogramming may be necessary).

ASCII call sign data

A : 65	B : 66	C : 67	D : 68
E : 69	F : 70	G : 71	H : 72
I : 73	J : 74	K : 75	L : 76
M : 77	N : 78	O : 79	P : 80
Q : 81	R : 82	S : 83	T : 84
U : 85	V : 86	W : 87	X : 88
Y : 89	Z : 90	Space : 32	
0 : 48	1 : 49	2 : 50	3 : 51
4 : 52	5 : 53	6 : 54	7 : 55
8 : 56	9 : 57		

Conversion of call sign to ASCII code

Digit :	1	2	3	4	5	6
Example:	W	D	6	D	J	Y
	(87)	(68)	(54)	(68)	(74)	(89)

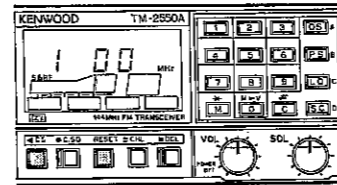
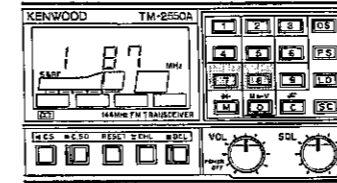
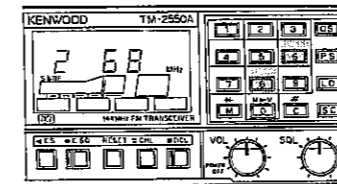
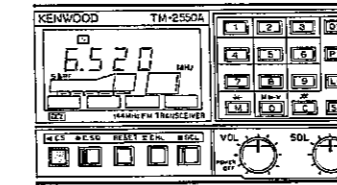
Operating procedure	Operation	Remarks
1. To display the call sign, first press the CS key and then, the RESET key. 	Each time the RESET key is pressed, the call sign and digital code will be displayed alternately. Referring to the lefthand illustration, 1 of "1 00" indicates the first digit of the call sign, WD6DJY, for example.	Whenever the call sign display has been selected by pressing the RESET key, the 1st digit of the call sign will always be displayed.
2. Enter the call sign, referring to the ASCII table on page 26, using the numeric keypad. 	To enter "W", press [8] then [7] on the numeric keypad. A short beep will sound each time you press a key to confirm data entry and the digit will appear in the display. A long beep will sound after the 2nd digit of each alphanumeric character, and the display will change to indicate the next character.	It is possible to receive, but not to transmit while entering the call sign. Attempting to transmit will cause an error alarm of three beeps to sound.
3. Enter the remaining characters. 	Enter the remaining characters using the key below; (D) = 68, (6) = 54, (D) = 68, (J) = 74, (Y) = 89. After the final 9 has been entered, the display will return to the first character position. Enter your call sign using the procedures in step 2 and 3.	To check the call sign data rotate the MEMORY CHANNEL selector. A beep will sound each time you display the first character.
4. Press the CS key to return to the normal frequency display. 	After all digits have been entered, press the CS key to return to the normal frequency display.	Remember that transmit is inhibited while entering the call sign.

4-8-9. DCL system notes

1. Standby digital code

The standby indicator is a visual indication of which digital access codes will actually open the squelch on the radio. Simply stated it shows the "Active" codes. When the indicator is "ON" the code is active, when the indicator is "OFF" the code is not active, and is ignored.

Fig. 1 illustrates an example code with the standby indicator "ON" (active).

The code that is displayed when the CS key is pressed "ON" (called a "Transmit digital code") becomes an active code regardless of the standby indicator. For example, the digital codes as shown in Fig. 2 are stored in station A's memory. Digital codes a, b and d are active codes. If station B transmits the proper code (a, b or d) he will open the squelch of station A.

When station A receives one of the active digital codes, the microprocessor will determine if the received code matches the current transmit code. If the codes do not match, the microprocessor will change the transmit digital code so that it matches the incoming digital code.

For example, if station B transmits a signal with code d (Fig. 2), the squelch of station A will open. Simultaneously, station A's transmit digital code (a in Fig. 2) will be changed to d. This may be confirmed by pressing the CS key. Code d will be displayed.

2. If the CHL indicator CHL is "ON" you will not be able to initiate, or receive channel linkage information. This is to prevent accidental channel linkage.

3. Detection of open channel

The DCL system detects the presence of an open channel by determining if the signal level is below approx. $-14 \text{ dB}\mu$ ($0.2 \mu\text{V}$) for approx. 1.5 seconds. Occasionally, channel linkage may occur on a busy channel due to transients in the microprocessor.

4. Automatic transmission of channel linkage data is not performed after finding an open channel, if another station is transmitting on the original channel at the time the radio returns to the original channel. The radio will enter the receive mode, and waits for a command to send the data.

5. Channel linkage during scan operation

Channel linkage cannot be actuated during scanning.

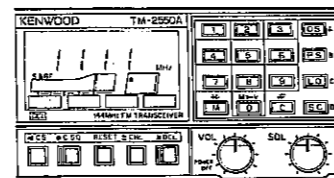

< Fig. 1 >

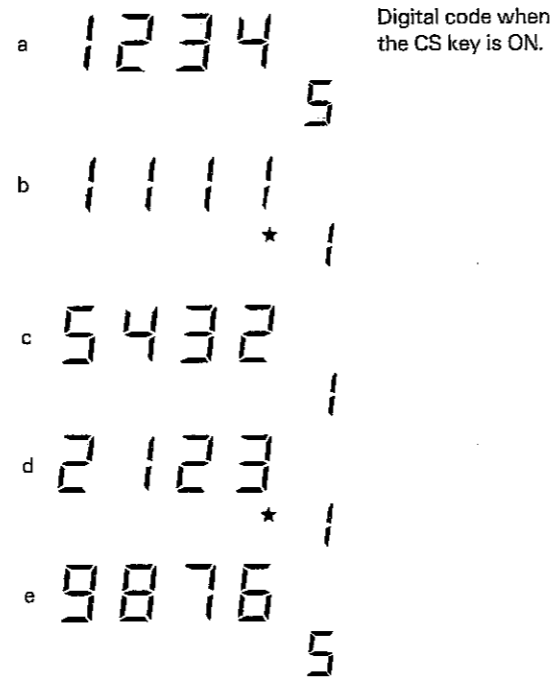

< Fig. 2 >

6. Normal transmission using PTT switch

When the DCL switch is ON, data is transmitted for approx. 0.2 seconds at the beginning and at the ending of the transmission: Wait a short period before start talking after this moment.

7. Offset switch

When the [OS] key is not set to simplex, automatic transmission of DCL data from the original frequency does not occur. Pressing the PTT switch manually transmits data and causes movement to the open channel.

8. When channel linkage is initiated, the original operating frequency, offset and tone frequency are stored into memory. The open channel operates in simplex with no tone, regardless of original settings.

5. MAINTENANCE AND ADJUSTMENT

5-1. GENERAL INFORMATION

Your transceiver has been factory aligned and tested to specification before shipment. Under normal circumstances, the transceiver will operate in accordance with the instructions in this manual.

If your transceiver fails to work, contact the authorized dealer from which you purchased it for quick, reliable repair. All adjustable trimmers and coils in your transceiver were preset at the factory and should only be readjusted

by a qualified technician with proper test equipment. Attempting service or alignment without factory authorization, may void the warranty. When operated properly, the transceiver can give years of service without requiring realignment. The information in this section gives some general service procedures which can be accomplished without sophisticated test equipment.

5-2. SERVICE

Should it ever become necessary to return the equipment to your dealer or service center for repair, pack it in its original box and packing, and include a full description of the problems involved. Also include your telephone number. You need not return accessory items unless directly related to the service problem. If you do include accessory items please list them in your correspondence.

You may return your radio for service to the Authorized TRIO-KENWOOD Dealer from whom you purchased it. A copy of the service report will be returned with the unit. Please do not send sub-assemblies or printed circuit boards. Send the complete unit, in its original boxes and packing.

Tag all returned items with your name and call for identification.

Please mention the model and serial number of your radio in any correspondence, whether phone or written. For future reference, record this information in the space provided on the back cover of this manual.

Service note:

Dear OM, if you desire to correspond on a technical or

operational problem, please make your note short, complete, and to the point. And PLEASE make it readable.

Please list: Model and serial number.

The question or problem you are having. Please give sufficient detail to diagnose: other equipment in the station, meter readings and anything you feel might be useful in attempting diagnosis.

Notes:

1. Record the date of purchase, serial number and dealer from whom purchased.
2. For your own information, retain a written record of any maintenance performed on the unit.
3. When claiming warranty service, please include a photocopy of the bill of sale, or other proof of purchase showing the date of sale.

Caution:

Do not pack the equipment in crushed newspapers for shipment! Extensive damage may result, during shipping.

5-3. CLEANING

The knobs, front panel and cabinet of the transceiver are likely to become soiled after extended use. The knobs should be removed from the transceiver and cleaned

with a neutral soap and warm water. Use a neutral soap (not harsh chemicals) and damp cloth to clean the cabinet and front panel.

5-4. MICROPROCESSOR BACK-UP LITHIUM BATTERY REPLACEMENT

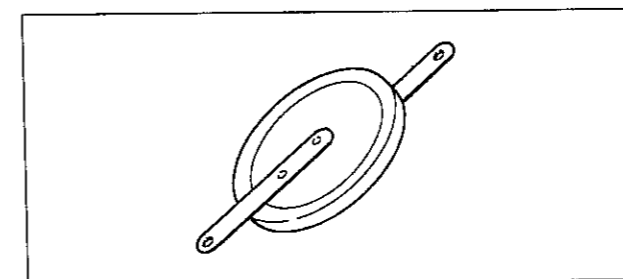

Lithium battery replacement should be performed by an authorized TRIO-KENWOOD service facility; either your TRIO-KENWOOD dealer, or the factory, since this unit contains CMOS type circuitry.

Note:

When the lithium battery is replaced, the microprocessor must be reset, using the procedure on page 35.

5-5. ORDERING SPARE PARTS

When ordering replacement or spare parts for your equipment, be sure to specify the following:
Model and serial number of your transceiver. Schematic number of the part. Printed circuit board number on

which the part is located, part number and name, if known, and quantity desired. Part numbers for most replacement parts is contained in the service manual (available as an option from your dealer).

5-6. ADJUSTMENTS

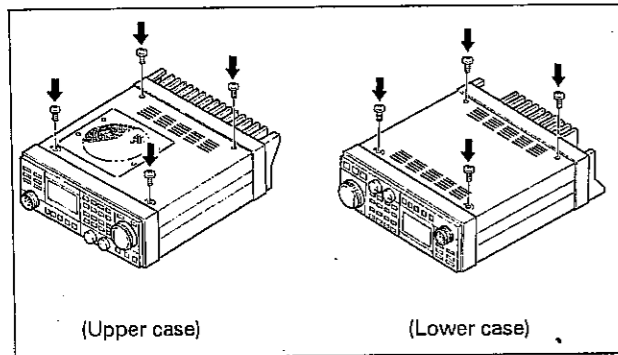

5-6-1. Cover removal

For each of the upper and lower cases, remove four screws as shown in the illustration. Be careful of the speaker wiring on the upper case.

Cautions:

1. Before removing the cover, turn the DC power supply's power switch OFF and disconnect the power cable.
2. Do not pinch wiring when opening or closing covers.

Notes:

- The following cautions pertain for the adjusting points.
1. Never touch adjustment points other than those indicated by the instructions.
 2. When adjusting or cutting a part, avoid contact with nearby parts.

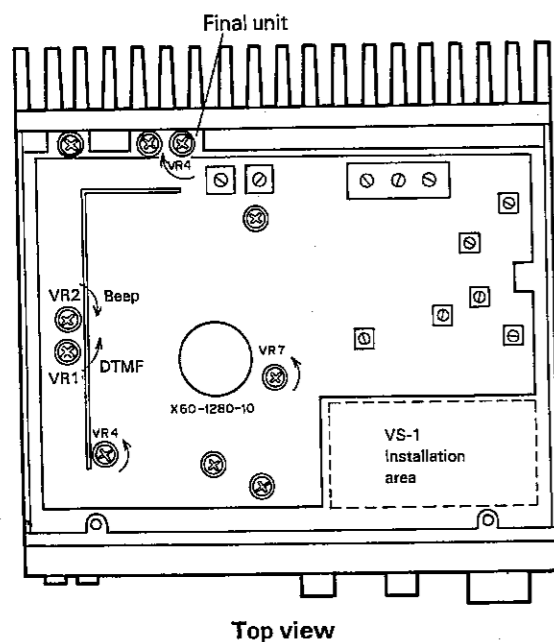

5-6-2. Low power output

Adjust VR4 on the Final unit to the desired power level. Adjustment is possible up to 60W with the TM-2570A, 40W with the TM-2550A/2550E and 20W with the TM-3530A/2530A.

5-6-3. Microphone gain

VR7 for microphone gain control.

5-6-4. DTMF level

Adjust VR1 (X60-1280-10) to the desired level.

5-6-5. Sidetone and beeper level

The autopatch sidetone level during and beeper level transmit are adjustable. As the volume is advanced, the level increases.

1. Adjust the VOL control to your normal listening level.
2. With the PTT pressed any key on the keyboard switch depressed, adjust VR2.

5-6-6. RF power meter

Adjustment is required after adjusting the low power output. VR4 for RF power meter.

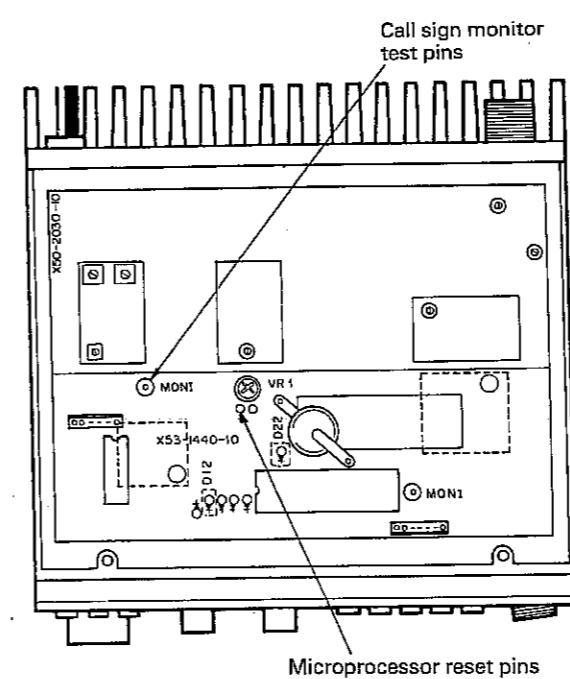

Bottom view

5-6-7. TO (Timer Operated) scan timer

The scan timer is factory preset at approximately 5 seconds. This can be adjusted from 3 to 15 seconds.

1. Place the SCAN switch to TO.
2. Turn the SQL control fully counterclockwise to open the squelch.
3. Press the M.CH switch to select memory mode.
4. Initiate scan by pressing the SC key.
5. Adjust VR1 (X53-1440-10) to the desired delay.

5-6-8. Open channel search step size selection (TM-3530A/2570A/2550A/2530A only)

Cut the diode D22 to change the open channel search step size for channel linkage from 15 kHz to 20 kHz (from 20 kHz to 40 kHz with the TM-3530A) steps.

Note:

When the diode (D22) is cut, reset the microprocessor using the procedure on page 15.

5-6-9. Microphone UP/DWN step size and scan step size selection (TM-2550E only)

The microphone UP/DWN step size and scan step size can be changed to 12.5 kHz by cutting D12 on the control unit (X53-1440-10). However, frequency entry by use of the numeric keypad is still possible in either 5 kHz or 12.5 kHz steps.

Note:

When the diode (D12) is cut, reset the microprocessor using the procedure on page 15.

5-6-10. Microprocessor reset pins

When the microprocessor reset using the procedure on page 15 is unable or the lithium battery is replaced, short these two pins while depressing the PS key.

5-6-11. Call sign monitor test pins

The test pins are short-circuited to monitor the own call signal when the Call Sign Display option is used. Be careful of noise interfering with the reception due to this operation.

6. BLOCK DIAGRAM

6-1. TM-3530A

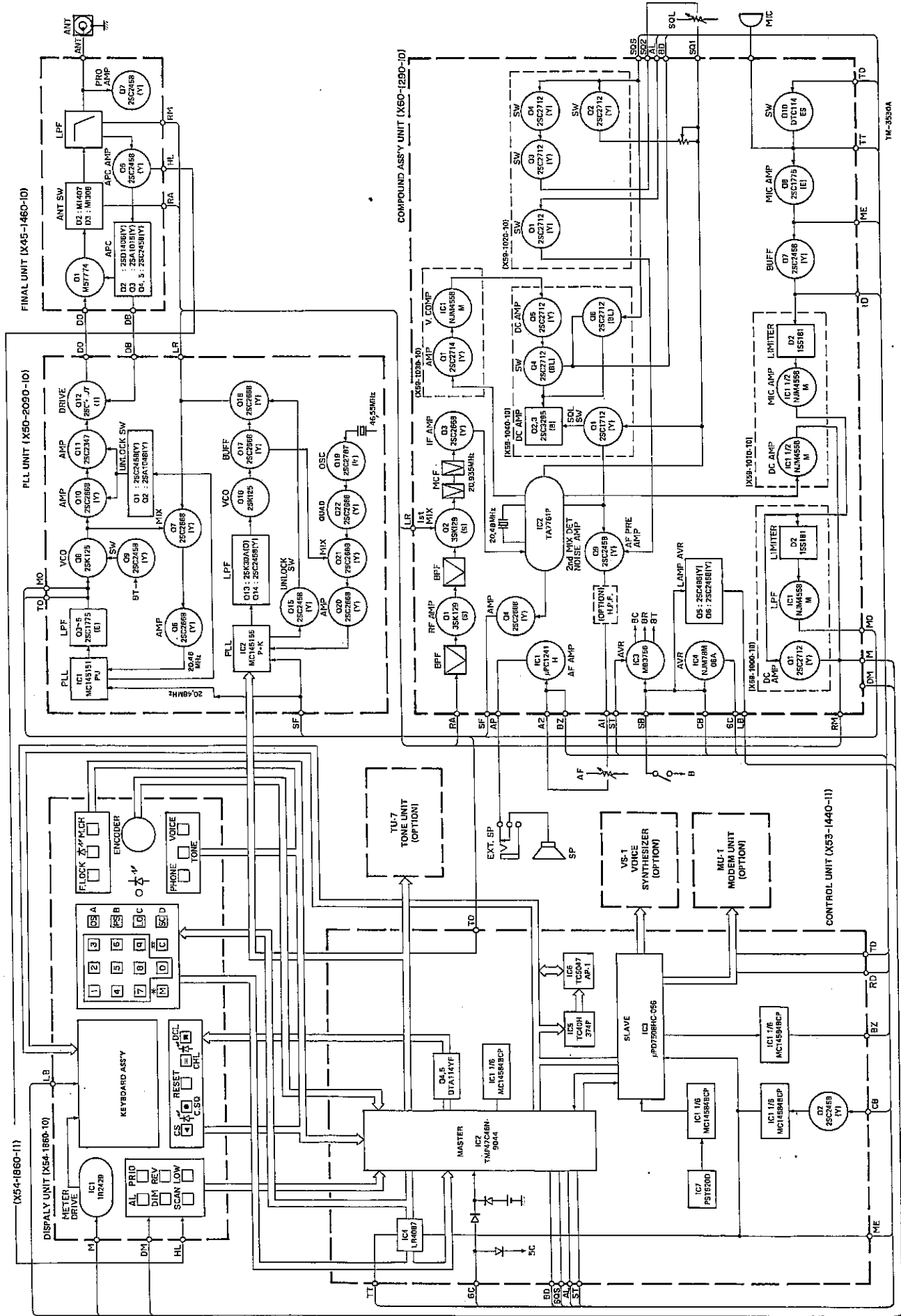

6-2. TM-2570A

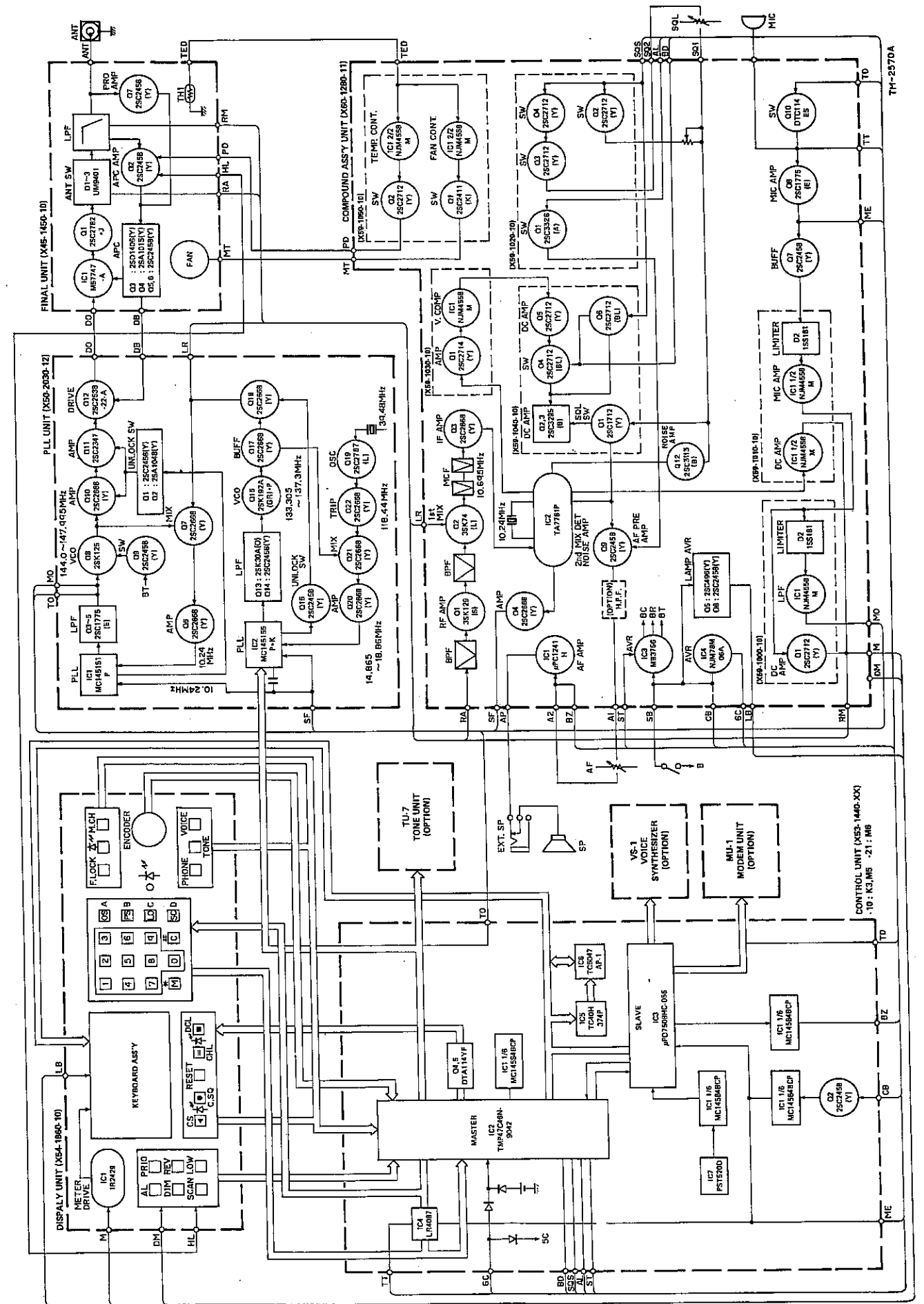

6-3. TM-2550A/2530A

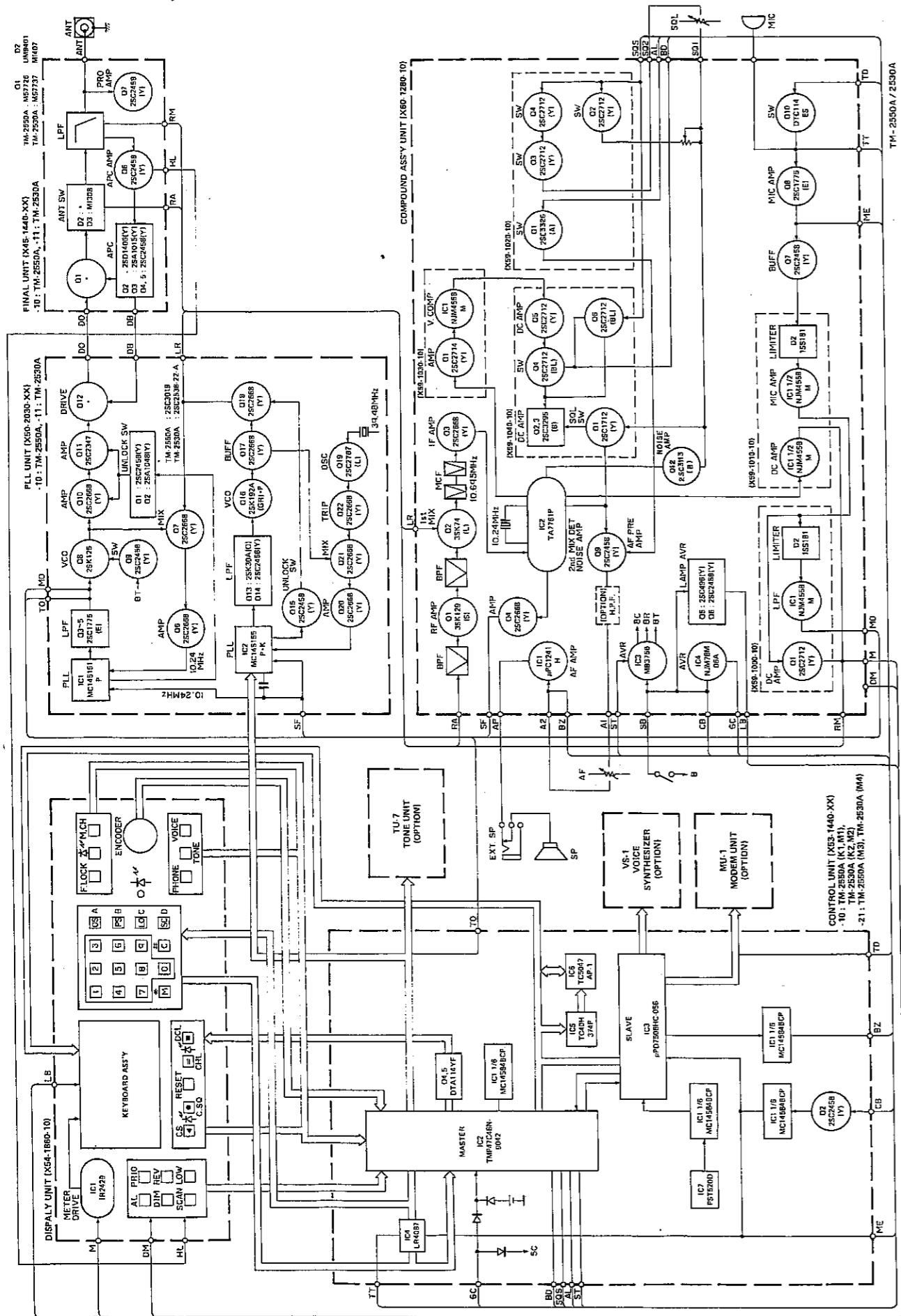

6-4. TM-2550E

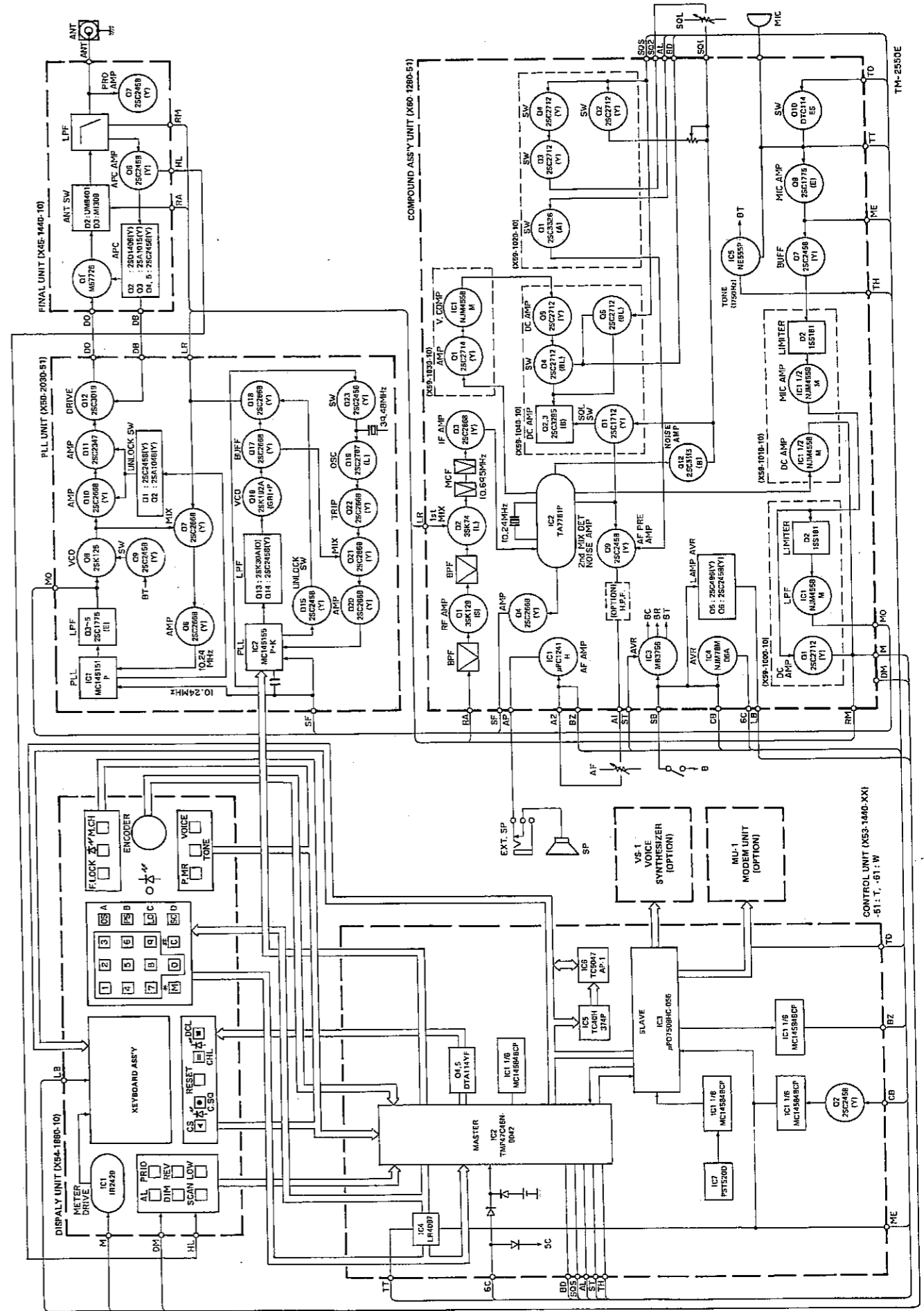

7. OPTIONAL ACCESSORIES

The following accessories are available for more sophisticated operation of your transceiver.

7-1. TU-7 TONE UNIT (TM-3530A/2570A/2550A/2530A only)

38 CTCSS tone frequencies can be selected from the front panel of the radio by using the TONE FREQUENCY selector. The selected tone is displayed in the LCD display.

Accessories:

1. Hexagonal boss (J32-0791-05) 1 pc.
2. Machine screw (N35-2604-41) 2 pcs.
3. Cable assembly..... (E31-3150-05)..... 1 pc.
4. Foam spacer (G13-0826-04) 1 pc.
5. Instruction manual..... (B50-8045-10)..... 1 copy

Installation procedure

Caution:

Before installation be sure to disconnect the power cable, or damage may result to the radio or tone unit.

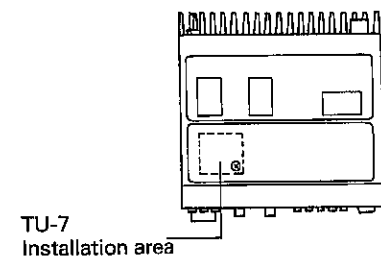

- ① Remove the four screws securing the bottom cover.
- ② Remove the machine screw near IC5 on the control unit (X53-1440-10) and replace it with the hexagonal boss.
- ③ Remove the backing from one side of the foam spacer and install the spacer on top of IC5 and IC6, as shown by the dotted line in the figure.
- ④ Connect the cable assembly to the TU-7 tone unit.
- ⑤ Remove the remaining backing from the foam spacer. Position the tone unit as shown and secure it to the chassis with the supplied machine screw. Note: Only one screw is needed.
- ⑥ Connect the cable assembly to the control unit as shown in the figure.

For details on operation of the TU-7 subaudible tone encoder please refer to section 4-6-2 on page 20.

* The output level of the tone encoder has been factory adjusted, and should not require further adjustment.

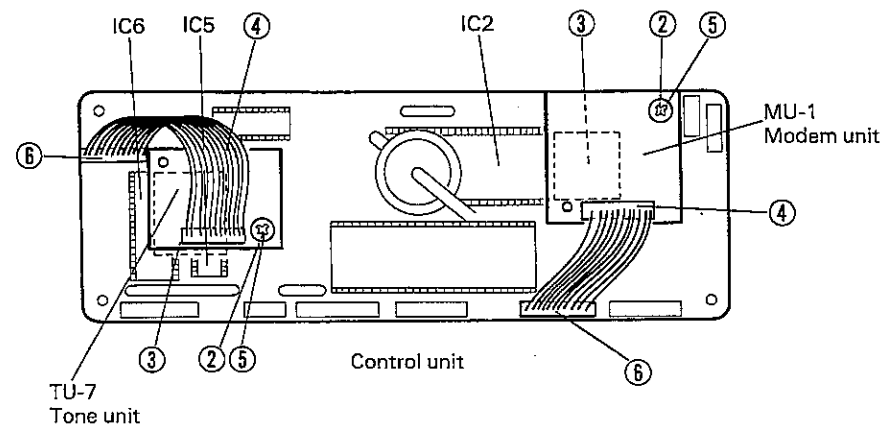

7-2. MU-1 MODEM UNIT

Installation of the MU-1 unit permits the DCL system operation.

Accessories:

1. Hexagonal boss (J32-0791-04) 1 pc.
2. Machine screw (N35-2604-41) 1 pc.
3. Cable assembly..... (E31-3151-05)..... 1 pc. (7 wire)
4. Foam spacer (G13-0826-04) 1 pc.
5. Instruction manual..... (B50-8046-10)..... 1 copy

Installation procedure

Caution:

Before installation, be sure to unplug the power cable, or damage may result to the radio or modem unit.

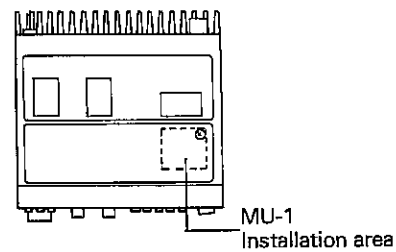

- ① Remove the four black screws securing the bottom cover.
- ② Remove the machine screw in the right rear corner of the control unit (X53-1440-10), and install the hexagonal boss in its place.
- ③ Remove the backing from one side of the foam spacer and install the spacer on the right end of IC2, as shown by the dotted line in the figure.
- ④ Connect the cable assembly to the MU-1 modem unit.
- ⑤ Remove the remaining backing from the foam spacer. Place the MU-1 unit as shown in the figure and secure it with the supplied machine screw. (Note only one screw is needed.)
- ⑥ Connect the cable assembly to the control unit as shown in the figure.
- ⑦ Reinstall the bottom cover to complete the installation.

For details on operation of the DCL system please refer to section 4-8 "DCL SYSTEM" on page 23.

* If the modem unit (MU-1) is not installed you will be able to program the DCL system, but no DCL signals will be transmitted or decoded.

7-3. VS-1 VOICE SYNTHESIZER UNIT

The operating frequency, DCL access code, call sign data, or subaudible tone data may be easily recalled by pressing the front panel VOICE switch.

Accessories:

1. Tapping screw (N89-3006-46) 4 pcs.
2. Instruction manual..... (B50-4035-00)..... 1 copy

Installation procedure

Caution:

Before installation, be sure to disconnect the power cord, or damage may occur to the voice unit or to the radio.

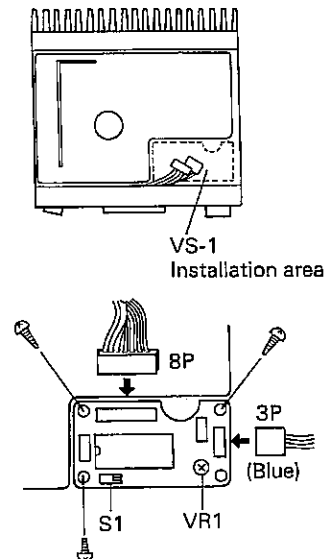

- ① Remove the four screws securing the top cover.

Note:

When removing the top cover, be careful not to damage the speaker wires. You must unplug the speaker cable.

- ② Connect the 3-pin blue connector to the corresponding blue jack on the VS-1 as shown.
- ③ Connect the 8-pin plug of the cable harness to the corresponding jack of the VS-1 as shown.
- ④ Secure the VS-1 to the chassis with 3 of the supplied self-tapping screws.
- ⑤ Reconnect the speaker wire, and replace the top cover to complete the installation.

Notes:

● Language selector switch

Switch S1 selects either the English (EN) or Japanese (JA) language.

● Talk speed selection

Speed is factory set at "standard" talk speed. Three different speeds can be selected.

The place in which a jumper wire to be placed.

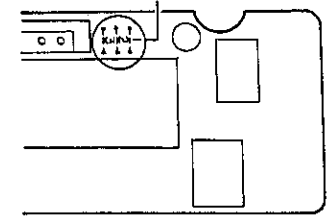

Jumper place	Speed	Std. speed	30% more than Std.	60% more than Std.
1		x	x	o
2		x	x	o
3		x	o	x

Symbol (o) denotes the place in which a jumper wire is placed.

Note:

When placing the jumper, solder carefully.

● Voice output level adjustment

Voice output level is factory adjusted. This level may be readjusted with VR1 if desired.

7-4. OTHER ACCESSORIES

■ PS-50 Heavy duty DC power supply

May be used with the TM-3530A/2570A/2550A/2550E/2530A for stable operation.

■ PS-430 DC power supply

May be used with the TM-3530A/2550A/2550E/2530A for stable operation. (Not for TM-2570A)

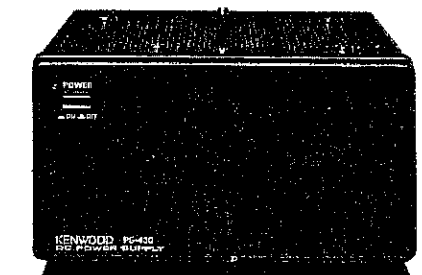

PS-430

■ **KPS-7A DC power supply (U.S.A. only)**

May be used with the TM-3530A/2530A.

■ **SP-430 External speaker**

The SP-430 is an attractive, compact external speaker. This low-distortion speaker provides clear reproduction of the high-quality audio obtained from the transceiver.

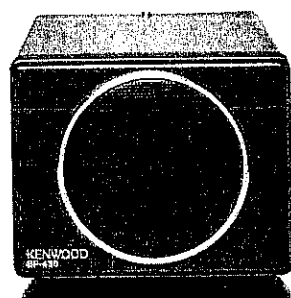

SP-430

■ **SP-50 Mobile speaker (8 Ω)**

Compact and smart high quality external speaker provides flexibility of installation for maximum convenience.

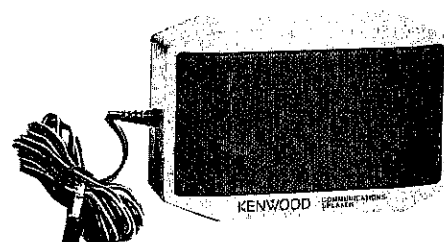

SP-50

■ **SP-40 Compact external speaker (4 Ω)**

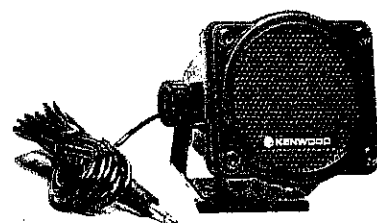

SP-40

■ **MC-85 Microphone (8 pin)**

The MC-85 is a unidirectional high-class electret condenser microphone provided with the output selective switch, audio level compensation circuit, low cut filter, level meter, PTT and LOCK switches. An 8-pin cable is provided, with optional cables, up to three outputs are possible.

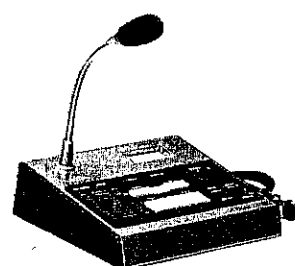

MC-85 Unidirectional electret condenser microphone

■ **MC-80 Microphone (8 pin)**

The MC-80 is an omnidirectional electret condenser microphone provided with UP/DOWN switches, volume adjustment for output level, PTT and LOCK switches, and built-in pre-amplifier.

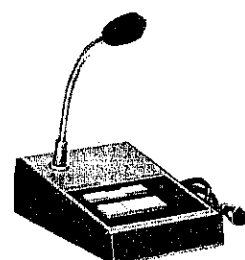

MC-80 Omnidirectional electret condenser microphone

■ **MC-60A Microphone (8 pin)**

The zinc die-cast base provides high stability, and the MC-60A is complete with PTT and LOCK switches, UP/DOWN switches, an impedance selector switch and a built-in pre-amplifier.



MC-60A Unidirectional dynamic microphone

■ **MC-55 Mobile microphone (8 pin)**

The MC-55 provides UP/DOWN switches, LED display for switching transmit or receive, adjustable microphone gain, automatic receive returning circuit (approx. 5 minutes) and many functions.



MC-55 Electret condenser microphone

■ **MC-48 Autopatch UP/DOWN hand microphone (8 pin)**

The MC-48 is 16-key auto-patch UP/DOWN microphones with PTT switch. Encodes 16 autopatch tones. UP/DOWN switches provide step frequency change, or initiate band scan in the appropriate direction, if held depressed momentarily.



MC-48

■ **MC-42S Up/Down hand microphone**

MC-42S is handy dynamic microphone with PTT switch and UP/DWN switches.



MC-42S

■ **MB-10 Mobile mount**

The mobile mount MB-10 allows easy installation and removal of the TM-3530A/2570A/2550A/2550E/2530A.

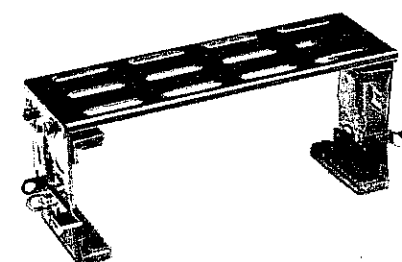

MB-10

■ **CD-10 Call sign display**

The CD-10 stores the call sign of the calling station in its memory and displays it on an LCD display. Call signs of up to 20 of the most recently calling stations are stored. Allowing the operator to quickly check for and return any call.

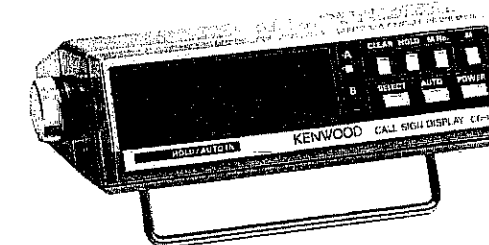

CD-10

■ **AC-10 AC adaptor for CD-10**

■ **PG-2N DC power cable**

■ **PG-3A 15A DC line noise filter**

May be used with the TM-3530A/2550A/2550E/2530A to suppress ignition noise. (Not for use with TM-2570A.)

■ **SW-200A/200B SWR/POWER meter (supplied with a coupler)**

SW-200A supplied with SWC-1. SW-200B supplied with SWC-2. Selectable Peak-reading/RMS. SWR/POWER meters cover 1.8 ~ 150 MHz (SW-200A), 140 ~ 450 MHz (SW-200B) in range of 0 ~ 20/200W, full scale for base station use.



SW-200A/200B

■ SW-100A/100B SWR/POWER meter

Compact and lightweight SWR/POWER/VOLT meters cover 1.8 ~ 150 MHz (SW-100A), 140 ~ 450 MHz (SW-100B) in range of 150W full scale for mobile use.

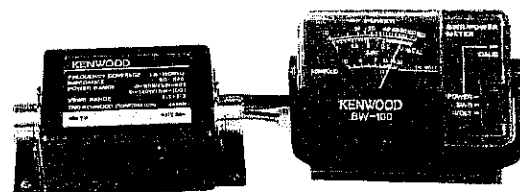

SW-100A/100B

■ SWT-1 Antenna tuning unit

The SWT-1 (2m band) is an antenna tuning unit designed for use in conjunction with an SWR/POWER meter to allow efficient transmission. This unit is especially convenient for monitoring SWR, using a KENWOOD SWR/POWER meter.

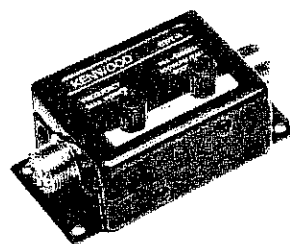

SWT-1

8. REFERENCE

8-1. ANTENNA

8-1-1. Fixed station

Various types of fixed station antennas are commercially available. Select your antenna according to available space and intended application.

Transceiver performance depends largely on the type of antenna used. For fixed station operation there are

ground plane antennas (omnidirectional) and Yagi antennas (unidirectional). The Yagi antenna is suitable for DX (Long distance) operation or communication with a specific party.

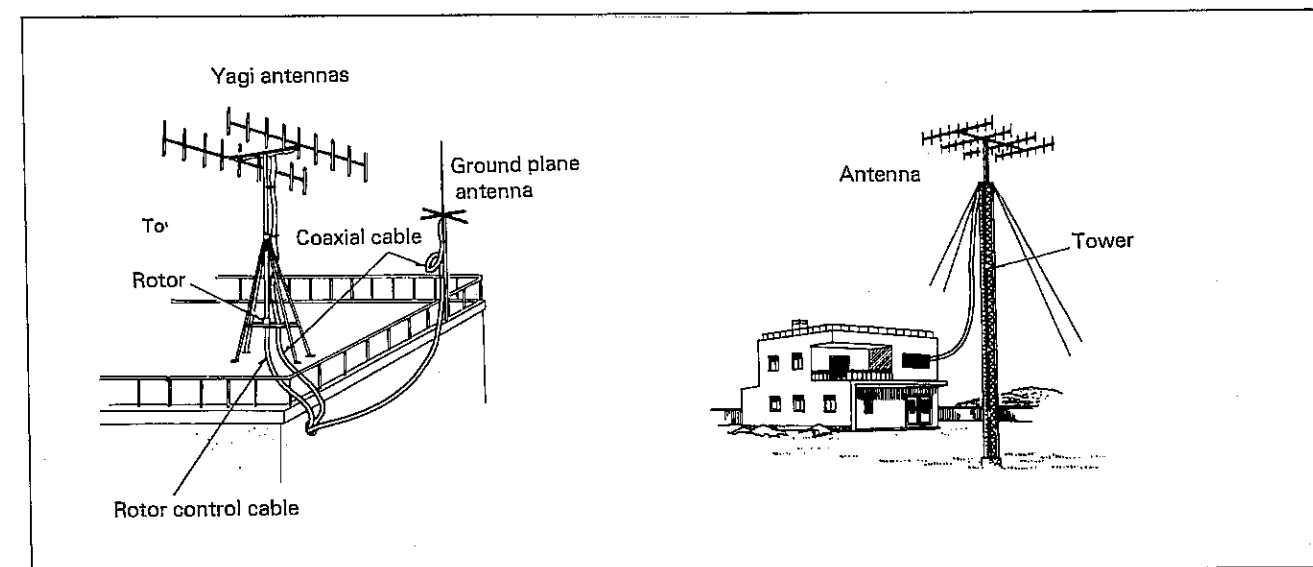

8-1-2. Mobile

Various types of antennas for VHF mobile operation are available.

Note:

For gutter-mount installation, the antenna bracket must be grounded to the car body as shown below. Attach the antenna securely, referring to the antenna installation instructions provided with the antenna.

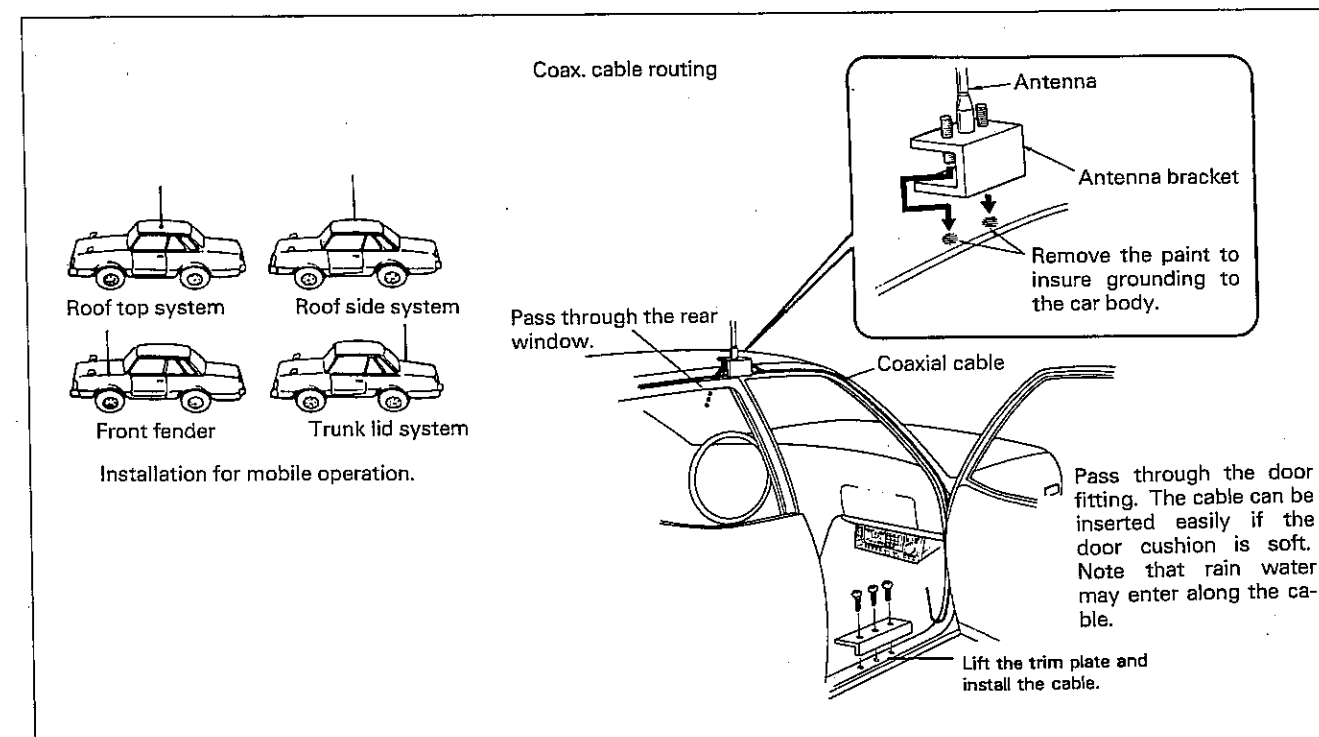

8-2. MOBILE INSTALLATION

8-2-1. Noise reduction

In motor vehicles, noise is generated by the ignition system. Other sources of noise include the wiper and heater motors.

Although the transceiver is equipped with a noise blanker to minimize ignition noise, it is imperative that some preventive measures be taken to reduce the noise to the lowest possible level.

a. Antenna location selection

Since ignition noise is generated by the vehicle's engine, the antenna must be installed as far from the engine as possible.

b. Bonding

The component parts of motor vehicles, such as the engine, transmission, muffler system, accelerator, etc., are

coupled to one another at DC and low frequencies, but are isolated at high frequencies. By connecting these parts using heavy, braided ground straps, ignition noise can be reduced. This connection is called "bonding".

c. Use ignition suppressor cable or suppressor spark plugs

Noise can be reduced by using spark plugs with internal resistors, or resistive suppressor ignition cable.

d. Battery power connection

It is recommended that battery power be supplied directly to the transceiver from the battery terminals.

Caution:

Disconnect the transceiver before jump-starting or before charging the battery.

8-2-2. Battery capacity

The power system of a motor vehicle is comprised of a battery and an alternator (which generates power while the engine is running) to supply current to loads or to charge the battery.

Since the transceiver draws high current during transmit, care should be exercised so the power system is not overloaded. When using the transceiver, the following points should be observed from the viewpoint of battery

maintenance:

- a. Turn the transceiver OFF when the lights, heater, wipers and other high-draw accessories are used.
- b. Avoid transceiver operation when the engine is not running.
- c. If necessary, use an ammeter and/or a voltmeter to check battery condition.

Model TM-3530A/2570A/2550A/2550E/2530A

Serial No. _____

Date of Purchase _____

Dealer _____

TRIO-KENWOOD CORPORATION

Shionogi Shibuya Building, 17-5, 2-chome Shibuya, Shibuya-ku, Tokyo 150, Japan

TRIO-KENWOOD COMMUNICATIONS
1111 West Walnut Street, Compton, California 90220, U.S.A.

TRIO-KENWOOD COMMUNICATIONS
DIVISION OF TRIO-KENWOOD ELECTRONICS GmbH
Rembrücker Str. 15, 8056 Heusenstamm, West Germany

TRIO-KENWOOD ELECTRONICS, N.V.
Leuvensesteenweg 504, B-1930 Zaventem Belgium

TRIO-KENWOOD (AUSTRALIA) PTY. LTD. (INCORPORATED IN N.S.W.)
4E Woodcock Place, Lane Cove, N.S.W. 2066, Australia