

KENWOOD

INSTRUCTION MANUAL

144/440 MHz FM DUAL BANDER

TH-G71A

144/430 MHz FM DUAL BANDER

TH-G71A

144/430 MHz FM DUAL BANDER

TH-G71E

KENWOOD CORPORATION

© B62-0739-00 (K,E,T,M)
09 08 07 06 05 04 03 02 01 00



THANK YOU!

We are grateful you decided to purchase this **KENWOOD** FM transceiver. This series of handhelds was developed to satisfy the requirement for a compact rig that's simple to operate yet contains numerous sophisticated features. **KENWOOD** believes that the compact size, coupled with reasonable cost, will meet your satisfaction.

MODELS COVERED BY THIS MANUAL

The models listed below are covered by this manual.

TH-G71A: 144/440 MHz FM Dual Bander
(U.S.A./ Canada)

TH-G71A: 144/430 MHz FM Dual Bander
(General market)

TH-G71E: 144/430 MHz FM Dual Bander
(Europe)

FEATURES

This transceiver has the following main features.

- Contains a total of 200 memory channels programmable with separate receive and transmit frequencies as well as simplex frequencies, and other various data.
- Allows each memory channel to be named using up to 6 alphanumeric characters; you may assign a name such as a callsign or repeater name.
- If programmed, the built-in Continuous Tone Coded Squelch System (CTCSS) rejects unwanted calls from other persons who are using the same frequency.
- Equipped with a high performance antenna.
- Illuminates the keys on the keypad as well as the display to permit easy operation in the dark.

NOTICES TO THE USER



ATTENTION (U.S.A. Only)

Nickel-Cadmium batteries must be replaced or disposed of properly.

State laws may vary regarding the handling and disposal of Nickel-Cadmium batteries.

Please contact your authorized **KENWOOD** dealer for more information.

One or more of the following statements may be applicable:

FCC WARNING

This equipment generates or uses radio frequency energy. Changes or modifications to this equipment may cause harmful interference unless the modifications are expressly approved in the instruction manual. The user could lose the authority to operate this equipment if an unauthorized change or modification is made.

INFORMATION TO THE DIGITAL DEVICE USER REQUIRED BY THE FCC

This equipment has been tested and found to comply with the limits for a Class B digital device, pursuant to Part 15 of the FCC Rules. These limits are designed to provide reasonable protection against harmful interference in a residential installation.

This equipment generates, uses and can generate radio frequency energy and, if not installed and used in accordance with the instructions, may cause harmful interference to radio communications. However, there is no guarantee that the interference will not occur in a particular installation. If this equipment does cause harmful interference to radio or television reception, which can be determined by turning the equipment off and on, the user is encouraged to try to correct the interference by one or more of the following measures:

- Reorient or relocate the receiving antenna.
- Increase the separation between the equipment and receiver.
- Connect the equipment to an outlet on a circuit different from that to which the receiver is connected.
- Consult the dealer for technical assistance.

PRECAUTIONS

Please observe the following precautions to prevent fire, personal injury, or transceiver damage:

- Do not transmit with high output power for extended periods. The transceiver may overheat.
- Do not modify this transceiver unless instructed by this manual or by **KENWOOD** documentation.
- When using a regulated power supply, connect the specified DC cable (option) to the DC jack on the transceiver. The supply voltage must be between 6 V and 16 V to prevent damaging the transceiver.
- When connecting the transceiver to a cigarette lighter socket in a vehicle, use the specified cigarette lighter cable (option).
- Do not expose the transceiver to long periods of direct sunlight nor place the transceiver close to heating appliances.
- Do not place the transceiver in excessively dusty areas, humid areas, wet areas, nor on unstable surfaces.
- If an abnormal odor or smoke is detected coming from the transceiver, turn OFF the power immediately and remove the battery case or the battery pack from the transceiver. Contact a **KENWOOD** service station or your dealer.

CONTENTS

SUPPLIED ACCESSORIES	1	Selecting Output Power	9
CONVENTIONS FOLLOWED IN THIS MANUAL	1	CHAPTER ⑤ MENU SET-UP	
CHAPTER ① PREPARATION		WHAT IS A MENU?	10
BATTERY OPERATING TIME	2	MENU ACCESS	10
INSTALLING THE NiCd BATTERY PACK	2	MENU CONFIGURATION	11
INSTALLING ALKALINE BATTERIES	3	CHAPTER ⑥ OPERATING THROUGH REPEATERS	
INSTALLING THE ANTENNA	4	REPEATER ACCESS	12
ATTACHING THE HAND STRAP	4	Selecting Offset Direction	13
INSTALLING THE BELT HOOK	4	Selecting Offset Frequency	13
CHAPTER ② FIRST QSO		Activating Tone Function	14
CHAPTER ③ GETTING ACQUAINTED		Selecting a Tone Frequency	14
ORIENTATION	6	Automatic Repeater Offset (U.S.A./ Canada/ Europe Only)	15
BASIC TRANSCEIVER MODES	6	REVERSE FUNCTION	16
DISPLAY	7	CHAPTER ⑦ MEMORY CHANNELS	
CHAPTER ④ OPERATING BASICS		SIMPLEX OR SPLIT MEMORY CHANNEL?	17
SWITCHING POWER ON/OFF	8	STORING DATA IN SIMPLEX CHANNELS	18
ADJUSTING VOLUME	8	STORING DATA IN SPLIT CHANNELS	18
ADJUSTING SQUELCH	8	RECALLING MEMORY CHANNELS	19
SELECTING A BAND	9	CLEARING MEMORY CHANNELS	19
SELECTING FREQUENCIES	9	NAMING MEMORY CHANNELS	20
TRANSMITTING	9	SWITCHING MEMORY NAME/ FREQUENCY DISPLAY	20

CALL CHANNEL	21
Recalling the Call Channel	21
Changing Call Channel Contents	21
MEMORY → VFO TRANSFERS	22
CHANNEL DISPLAY FUNCTION	22
INITIALIZING MEMORY	23
Partial Reset (VFO)	23
Full Reset (Memory)	23

CHAPTER ⑧ SCAN

SCAN RESUME METHODS	25
Selecting Scan Resume Method	25
VFO SCAN	26
MEMORY SCAN	26
Locking Out Memory Channels	27
MHz SCAN	27
PROGRAM SCAN	28
Setting Scan Limits	28
Using Program Scan	29
CALL/VFO SCAN	29
CALL/MEMORY SCAN	29
PRIORITY SCAN	30
Storing Frequency in Priority Channel	30
Selecting Priority Scan Method	31
Using Priority Scan	31

CHAPTER ⑨ CONTINUOUS TONE CODED SQUELCH SYSTEM (CTCSS)

USING CTCSS	32
Automatic Tone Frequency ID	33

CHAPTER ⑩ DUAL TONE MULTI-FREQUENCY (DTMF) FUNCTIONS

MAKING DTMF CALLS	34
DTMF Tone TX Hold	34
Autopatch (U.S.A. and Canada)	34
STORING DTMF NUMBERS FOR AUTOMATIC DIALER	35
CONFIRMING STORED DTMF NUMBERS	35
TRANSMITTING STORED DTMF NUMBERS	36

CHAPTER ⑪ AUXILIARY FUNCTIONS

TX INHIBIT	37
TRANSCIVER LOCK	37
AUTOMATIC POWER OFF (APO)	37
BATTERY SAVER	37
LAMP FUNCTION	38
BEEP ON/OFF	38
SWITCHING AM/FM MODE (U.S.A./ CANADA ONLY)	38
TONE ALERT	38

1

2

3

4

5

6

7

8

9

10

11

12

13

14

15

PROGRAMMABLE VFO	39
CHANGING SPEAKER CONFIGURATIONS	39
KEYPAD DIRECT ENTRY	40
Frequency Entry	40
Memory Channel Number Entry	40
CHANGING FREQUENCY STEP SIZE	40

CHAPTER 12 MICROPHONE CONTROL

CHAPTER 13 MAINTENANCE

GENERAL INFORMATION	42
SERVICE	42
SERVICE NOTE	42
CLEANING	42
CHARGING THE NiCd BATTERY PACK	43
TROUBLESHOOTING	44

CHAPTER 14 OPTIONAL ACCESSORIES

CHAPTER 15 EQUIPMENT INSTALLATION AND CONNECTION

CONNECTING AN EXTERNAL POWER SOURCE	47
Using a Regulated Power Supply	47
Using a Cigarette Lighter Socket	47
CONNECTING EQUIPMENT FOR REMOTE CONTROL	48

CONNECTING OTHER EXTERNAL EQUIPMENT	48
---	----

SPECIFICATIONS

QUICK REFERENCE GUIDE

INDEX

SUPPLIED ACCESSORIES

Accessory	Part Number	Quantity
Antenna	T90-0634-XX	1
NiCd battery pack PB-38 (6 V, 650 mAh) ¹	W09-0909-XX	1
PB-39 (9.6 V, 600 mAh) ¹	W09-0911-XX	1
Battery case (BT-11) ¹	A02-2078-XX	1
Battery charger		
U.S.A./ Canada	W08-0437-XX	1
United Kingdom	W08-0438-XX	1
Europe	W08-0440-XX	1
General	W08-0441-XX	1
AC plug adapter ²	E19-0254-XX	1
Belt hook	J29-0631-XX	1
Hand strap	J69-0339-XX	1
Warranty card	—	1
U.S.A./ Canada/ Europe only		
Instruction manual	B62-0739-XX	1

¹ Depending on the markets, PB-38, PB-39, or BT-11 is provided.

² Some General market versions only

CONVENTIONS FOLLOWED IN THIS MANUAL

The writing conventions described below have been followed to simplify instructions and avoid unnecessary repetition.

ATTENTION: MOST PROCEDURES REQUIRE THAT YOU PRESS AN APPROPRIATE KEY IN EACH STEP WITHIN APPROXIMATELY 10 SECONDS, OR THE PREVIOUS MODE WILL BE RESTORED.

Instruction	What to do
Press [KEY].	Press and release KEY .
Press [KEY] (1 s).	Press and hold KEY until the function begins.
Press [KEY1], [KEY2].	Press KEY1 momentarily, release KEY1 , then press KEY2 .
Press [KEY1]+[KEY2].	Press and hold KEY1 , then press KEY2 .
Press [KEY]+ POWER ON.	With transceiver power OFF, press and hold KEY , then press the PWR switch.

PREPARATION

1 BATTERY OPERATING TIME

The following table shows the approximate battery life (hours) relative to the transmit output power.

Batteries	VHF Band			UHF Band		
	HI	LO	EL	HI	LO	EL
PB-38 NiCd	4.5	10	13	4.5	8	12
PB-39 NiCd	3.5	8	14	3.2	7.2	14
Alkaline	14	28	40	14	27	30

INSTALLING THE NiCd BATTERY PACK

Note: Because the battery pack is provided uncharged, charge the battery pack before using it with the transceiver. For the method of charging the battery pack, refer to "CHARGING THE NiCd BATTERY PACK" {page 43}.

- 1 Position the two grooves on the inside bottom corners of the battery pack over the corresponding guides on the back of the transceiver.

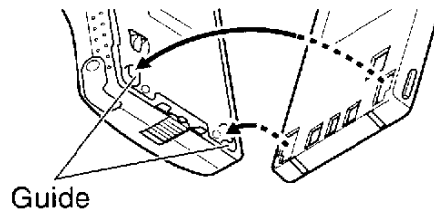

- 2 Slide the battery pack along the back of the transceiver until the release catch on the base of the transceiver locks the battery pack in place.

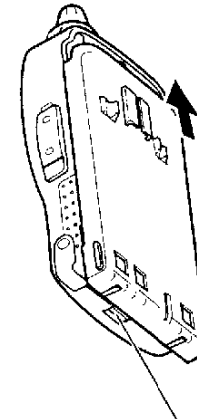

Release catch

- 3 To remove the battery pack, push up the release catch, then slide the battery pack back.

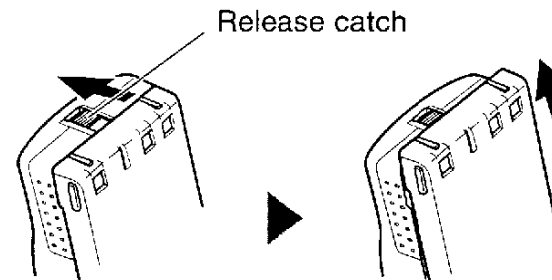

INSTALLING ALKALINE BATTERIES

WARNING!

- ◆ DO NOT INSTALL THE BATTERIES IN A HAZARDOUS ENVIRONMENT WHERE SPARKS COULD CAUSE AN EXPLOSION.
- ◆ NEVER DISCARD OLD BATTERIES IN FIRE BECAUSE EXTREMELY HIGH TEMPERATURES CAN CAUSE BATTERIES TO EXPLODE.

Note:

- ◆ It is recommended to use high quality alkaline batteries rather than manganese batteries to enjoy longer periods of battery life. Do not use commercially available NiCd batteries.
- ◆ If you will not use the transceiver for a long period, remove the batteries from the battery case.
- ◆ Do not use different quality of batteries together.
- ◆ When the battery voltage is low, replace all four old batteries with new ones.

- 1 To open the battery case cover, push on the locking tab, then pull the cover.

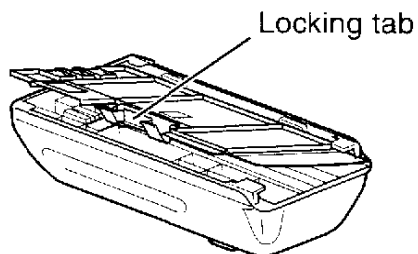

- 2 Insert (or remove) four AA (LR6) alkaline batteries.
 - Be sure to match the battery polarities with those marked on the bottom of the battery case.

1

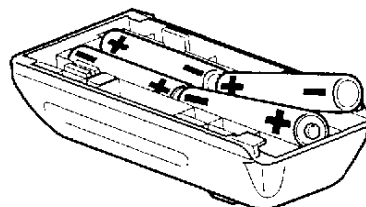

- 3 Align the two tabs on the battery case cover, then close the cover until the locking tab clicks.

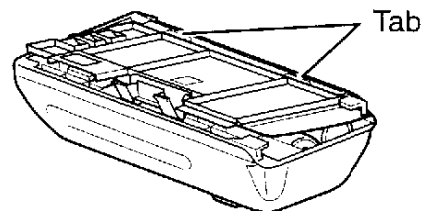

- 4 To install the battery case onto (or remove from) the transceiver, follow steps 1 to 3 for INSTALLING THE NiCd BATTERY PACK {page 2}.

INSTALLING THE ANTENNA

- 1 Hold the provided antenna at its base, and screw the antenna into the connector on the top panel of the transceiver until it is snug.

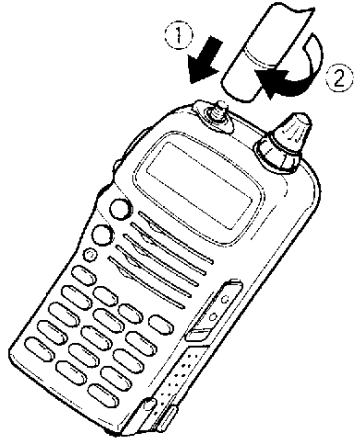

ATTACHING THE HAND STRAP

If you want, attach the provided hand strap to the belt hook before installing the hook onto the transceiver.

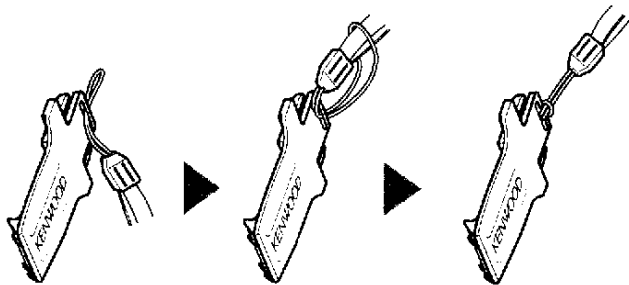

INSTALLING THE BELT HOOK

Install the provided belt hook onto the back of the battery pack or the battery case.

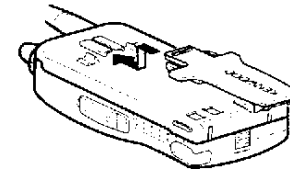

- To lock the cable of an optional speaker microphone, first position the cable over the left groove on the transceiver. Then install the belt hook. Last position the cable over the right groove.

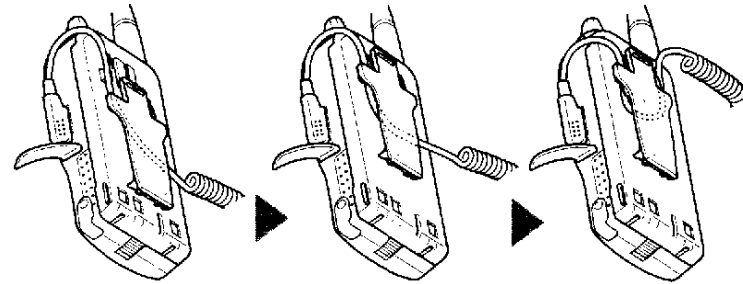

To remove the belt hook, pull the belt hook downward while pushing its tabs from both sides.

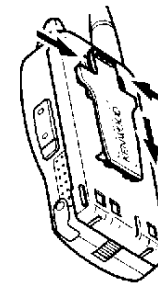

FIRST QSO

The 7 steps given here will get you on the air in your first QSO right away. So, you can enjoy the exhilaration that comes with opening a brand new transceiver.

❶ Press the **PWR** switch for 1 second or longer.

❷ Turn the **VOL** control clockwise to the 11 o'clock position.

❸ Press [**BAND**] to select the VHF or UHF band.

❹ Turn the **Tuning** control to select a frequency.

❺ Press and hold the **PTT** switch, then speak in a normal tone of voice.

❻ Release the **PTT** switch to receive.

❼ Repeat steps ❺ and ❻ to continue communication.

Note: When received signals are too weak to recognize, press and hold [**MONI**] to hear clearer signals. You will, however, also hear background noise.

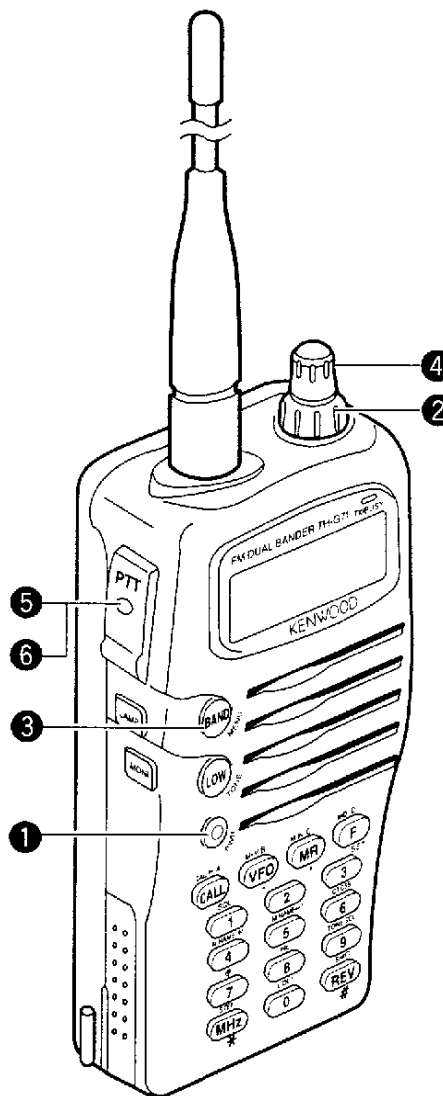

CAUTION:

- ◆ THE RECOMMENDED DUTY CYCLE IS 1 MINUTE OF TRANSMISSION AND 3 MINUTES OF RECEPTION. LONGER TRANSMISSIONS OR EXTENDED OPERATION IN THE HIGH POWER MODE MAY CAUSE THE BACK OF THE TRANSCEIVER TO GET HOT.
- ◆ TRANSMITTING WITH THE SUPPLIED ANTENNA NEAR OTHER ELECTRONIC EQUIPMENT CAN INTERFERE WITH THAT EQUIPMENT. ALSO, TRANSMITTING NEAR A REGULATED POWER SUPPLY, THAT IS NOT RECOMMENDED BY **KENWOOD**, MAY CAUSE THE POWER SUPPLY TO OUTPUT AN EXTREMELY HIGH VOLTAGE. THIS VOLTAGE COULD DAMAGE BOTH YOUR TRANSCEIVER AND ANY OTHER EQUIPMENT CONNECTED TO THE POWER SUPPLY.

Note: If input voltage exceeds approximately 18 V, warning beeps sound and "DC ERR" appears on the display.

2

GETTING ACQUAINTED

ORIENTATION

3

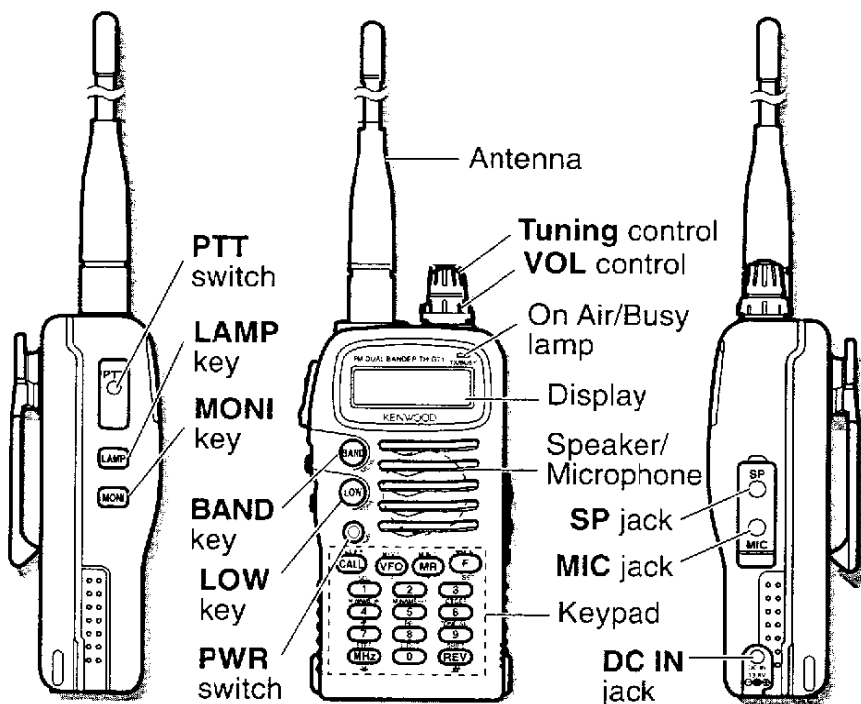

BASIC TRANSCEIVER MODES

This section introduces you to the basic modes you can select on this transceiver.

VFO mode

Press [VFO] to select. In this mode you can change the operating frequency using the **Tuning** control.

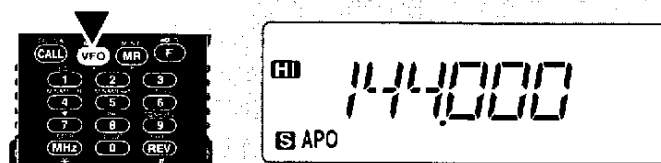

Memory Recall mode

Press [MR] to select. In this mode you can change memory channels, using the **Tuning** control, where you stored frequencies and related data. You cannot enter this mode unless you program one memory channel at least. For further information, refer to "MEMORY CHANNELS" {page 17}.

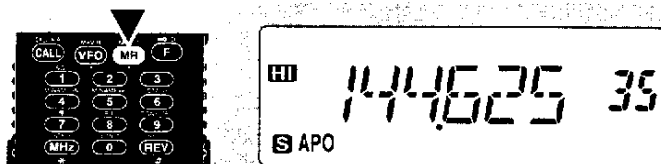

Menu mode

Press **[F]**, **[BAND]** to select. In this mode you can change Menu Nos. using the **Tuning** control.

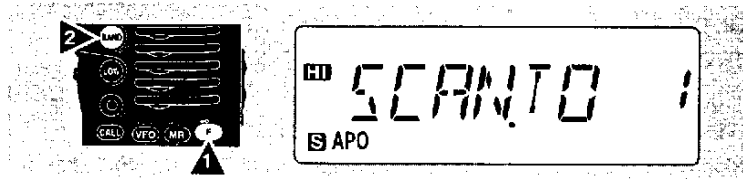

DISPLAY

On the display you will see various indicators that show what you have selected. Sometimes you may not recall what those indicators mean or how you can cancel the current setting. In such a case, you will find the following table very useful.

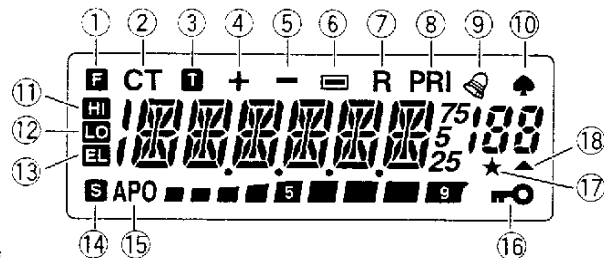

Displays various alphanumeric information such as an operating frequency or menu selection.



Displays the current memory channel when in Memory Recall mode.



Shows the strength of received signals. While transmitting, shows the current relative battery charge.

	Indicator	What You Selected	What You Press to Cancel	Ref. Page
①	F	Second function select mode	[F]	—
②	CT	CTCSS	[F] , [6]	32
③	T	Tone function	[F] , [LOW]	14
④	+	Plus offset direction	[F] , [REV] , [F] , [REV] (TH-G71E: one more [F] , [REV])	13
⑤	-	Minus offset direction	[F] , [REV] (TH-G71E: one more [F] , [REV])	13
⑥	=	Minus offset direction (-7.6 MHz) ¹	[F] , [REV]	13
⑦	R	Reverse function	[REV]	16
⑧	PRI	Priority Scan	[F] , [8]	31
⑨		Tone Alert	[F] , [7]	38
⑩		AM mode	Use Menu No.16	38
⑪	H	High transmit power	Default setting	9
⑫	LO	Low transmit power	[LOW] , [LOW] to restore default	9
⑬	EL	Economic low transmit power	[LOW] to restore default	9
⑭	S	Battery Saver	Use Menu No. 4	37
⑮	APO	Automatic Power Off	Use Menu No. 5	37
⑯		Transceiver Lock	[F] (1 s)	37
⑰	★	Memory Channel Lockout	[F] , [0]	27
⑱		Memory channel containing data	—	18

¹ TH-G71E only

OPERATING BASICS

SWITCHING POWER ON/OFF

- 1 Press the **PWR** switch (1 s) to switch ON the transceiver.
 - A beep sounds.

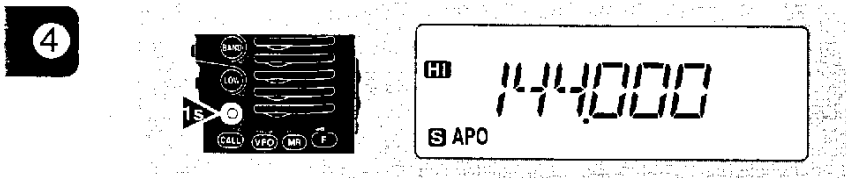

- 2 To switch OFF the transceiver, press the **PWR** switch (1 s) again.

ADJUSTING VOLUME

Turn the **VOL** control clockwise to increase the audio level and counterclockwise to decrease the audio level.



- If background noise is inaudible because of the Squelch function, press and hold **[MONI]**, then turn the **VOL** control. While pressing **[MONI]**, you will hear background noise.

ADJUSTING SQUELCH

The purpose of the Squelch function is to silence background noise output from the speaker (squelch closed) when no signals are present. When the squelch level is set correctly, you will hear sound (squelch opened) only while a station is actually being received.

- 1 Press **[F]**, **[1]**.
 - The current squelch level appears. The default is level 2.

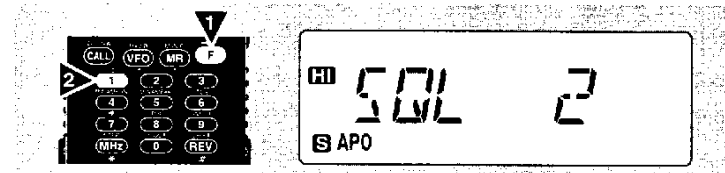

- 2 Turn the **Tuning** control to select the squelch level in the range 0 to 5.
 - Select just the level at which the background noise is eliminated when no signal is present.
 - The larger the level number you select, the stronger the signals you need to receive to hear.

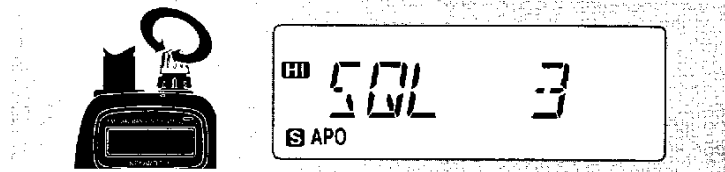

- 3 Press any key other than **[LAMP]** and **[MONI]** to complete the setting.

SELECTING A BAND

Press [**BAND**] to select the VHF or UHF band.

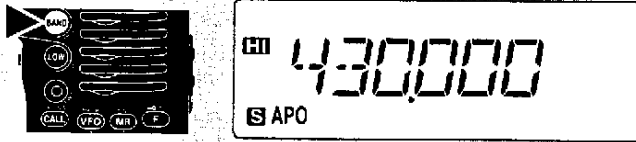

Note: If in Memory Recall mode (page 6), press [**VFO**], then press [**BAND**] to select a band.

SELECTING FREQUENCIES

Turn the **Tuning** control clockwise to increase the frequency or counterclockwise to decrease the frequency.

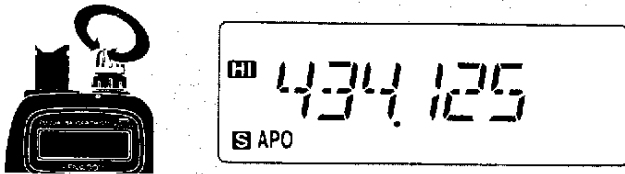

- To change frequencies in steps of 1 MHz, press [**MHz**] first. 1 MHz digit blinks. Pressing [**MHz**] again cancels this function.
- If you cannot select a particular frequency, the frequency step size needs to be changed. See "CHANGING FREQUENCY STEP SIZE" (page 40).
- You can also select frequencies with the numeric keys. See "KEYPAD DIRECT ENTRY" (page 40).

TRANSMITTING

1 When ready to begin transmitting, press and hold the **PTT** switch and speak in a normal tone of voice.

- The On Air lamp lights red and the battery meter appears.



- Speaking too close to the microphone, or too loudly, may increase distortion and reduce intelligibility of your signal at the receiving station.
- The battery meter shows the current relative battery charge.

2 When you finish speaking, release the **PTT** switch.

Time-Out Timer: Holding down the **PTT** switch for more than 10 minutes causes the transceiver to generate a beep and stop transmitting. Release, then press the **PTT** switch to resume transmitting. You cannot switch this function OFF.

■ Selecting Output Power

Press [**LOW**] to select high (default), low, or economic low power (lowest).

- "HI", "LO", or "EL" appears to show the current selection.

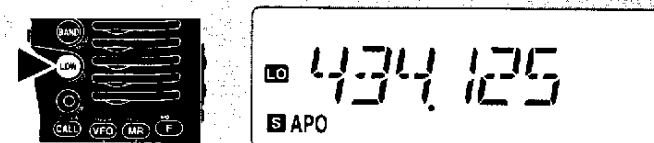

Note: Selecting lower transmit power is a wise method to reduce battery consumption if communication is still reliable.

MENU SET-UP

WHAT IS A MENU?

Many functions on this transceiver are selected or configured via a software-controlled Menu instead of physical controls on the transceiver. Once familiar with the Menu system, you will appreciate the versatility it offers.

5 MENU ACCESS

- 1 Press [F], [BAND] to enter Menu mode.
 - The last Menu No. used appears.

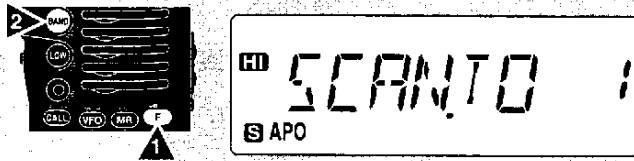

- 2 Turn the **Tuning** control to select the desired Menu No.

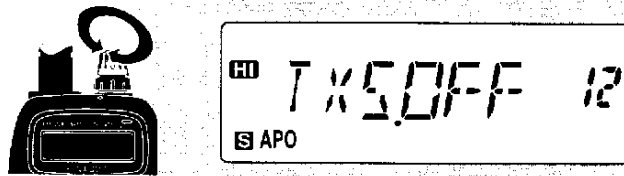

- 3 Press [BAND] to switch the selection.

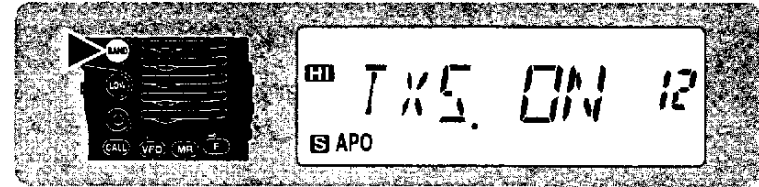

- Depending on Menu Nos., press [BAND], then turn the **Tuning** control to select numeric values. Press [BAND] again to complete the setting.
- 4 Press any key other than [BAND], [LAMP], and [MONI] to exit Menu mode.

MENU CONFIGURATION

Menu No.	Description	Selections	Default	Ref. Page
1	Scan resume method	Time-Operated (TO)/ Carrier-Operated (CO)/ Seek (SE)	Time-Operated	25
2	Memory recall method	All bands (ALL)/ Single band (ONE)	All bands	19
3	Programmable VFO (Upper/ lower limits)	Frequencies selectable on the band	Upper/lower receive frequency limits on the band	39
4	Battery Saver	ON/OFF	ON	37
5	Automatic Power Off	ON/OFF	ON	37
6	Beep function	ON/OFF	ON	38
7	Automatic Repeater Offset	ON/OFF	ON	15
8	Offset frequency	00.000 MHz to 29.950 MHz	See reference page.	13
9	Tuning Control Enable	ON/OFF	OFF	37
10	DTMF number storing/ confirming	See reference page.		35
11	Priority Scan method	Mode A/ Mode B	Mode A	31
12	TX Inhibit	ON/OFF	OFF	37
13	DTMF Tone TX Hold	ON/OFF	OFF	34
14	Speaker configuration	Single speaker (ONE)/ Two speakers (BOTH)	Single speaker	39
15	Transceiver Control ¹	ON/OFF	OFF	—
16	AM/FM selection (U.S.A./Canada only)	AM mode/ FM mode	AM mode	38

¹ This menu item is used for controlling the transceiver using a personal computer. For further information, consult your dealer.

OPERATING THROUGH REPEATERS

Repeaters are often installed and maintained by radio clubs, sometimes with the cooperation of local businesses involved in the communications industry.

Compared to simplex communication, you can usually transmit over much greater distances by using a repeater. Repeaters are typically located on a mountain top or other elevated location. Often they operate at higher ERP (Effective Radiated Power) than a typical station. This combination of elevation and high ERP allows communications over considerable distances.

6

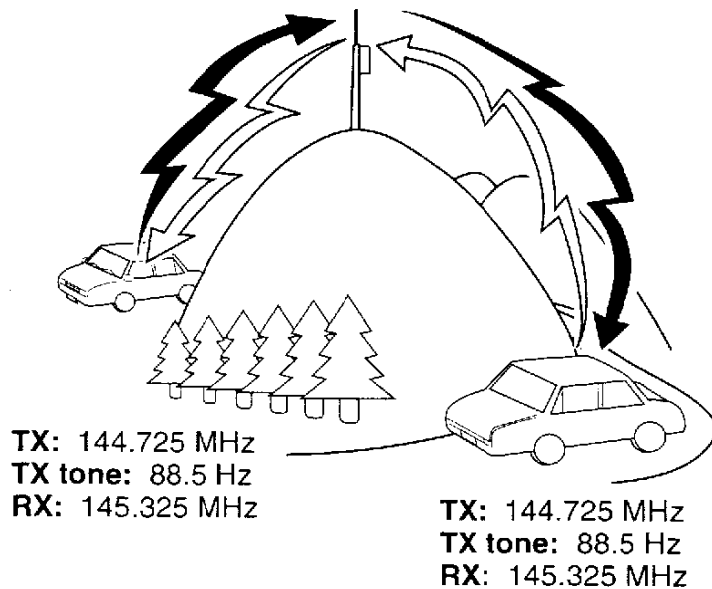

REPEATER ACCESS

Most amateur radio voice repeaters use a separate receive and transmit frequency. You can set a separate transmit frequency by selecting the offset frequency and offset direction with respect to the receive frequency. In addition, some repeaters may require the transceiver to transmit a tone before the repeater can be used. To transmit this required tone, activate the Tone function and select a tone frequency.

The required offset direction, offset frequency, and tone frequency depend on the repeater you are accessing. Consult your local repeater reference.

Flow Chart for Repeater Access

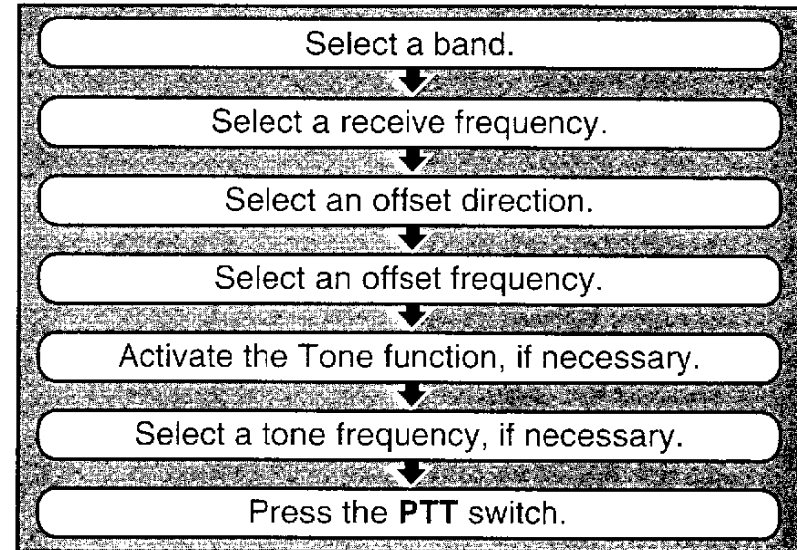

■ Selecting Offset Direction

Select whether the transmit frequency will be higher (+) or lower (−) than the receive frequency.

- 1 Select the desired band.
- 2 Press **[F]**, **[REV]**.
 - Each time you repeat this key operation, the offset direction changes as shown below.

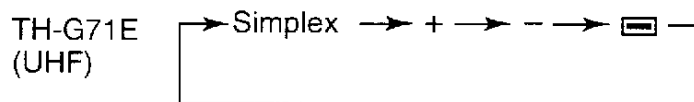
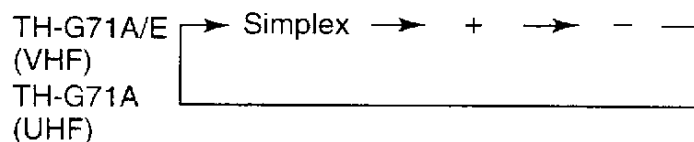

☐ : Programs −7.6 MHz offset.

If the offset transmit frequency falls outside the allowable transmit frequency range, transmitting is inhibited until the transmit frequency is brought within the band limits by one of the following methods:

- Move the receive frequency further inside the band.
- Change the offset direction.

Note: While using a split memory channel or transmitting, you cannot change the offset direction.

■ Selecting Offset Frequency

Select how much the transmit frequency will be offset from the receive frequency. The default offset frequency on the VHF band is 600 kHz no matter which market version; the default on the UHF band is 5 MHz (TH-G71A) or 1.6 MHz (TH-G71E).

- 1 Select the desired band.
- 2 Press **[F]**, **[BAND]** to enter Menu mode.
- 3 Select Menu No. 8 (OFFSET).

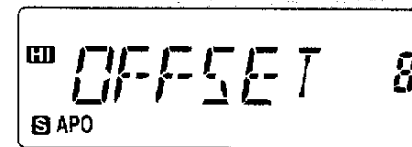

6

- 4 Press **[BAND]**, then select the appropriate offset frequency.
 - The selectable range is from 00.000 MHz to 29.950 MHz in steps of 50 kHz.

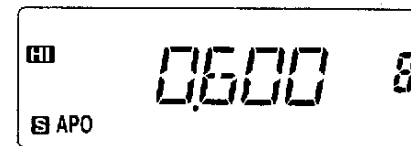
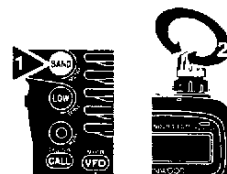

- 5 Press **[BAND]** again to complete the setting.
- 6 Press any key other than **[BAND]**, **[LAMP]**, and **[MONI]** to exit Menu mode.

TH-G71E only: If you have selected "☐" for the offset direction, you cannot change the default (−7.6 MHz).

Note: After changing the offset frequency, the new offset frequency will also be used by Automatic Repeater Offset.

■ Activating Tone Function

- 1 Select the desired band.
- 2 Press [F], [LOW] to switch the Tone function ON (or OFF).
 - "T" appears when the Tone function is ON.

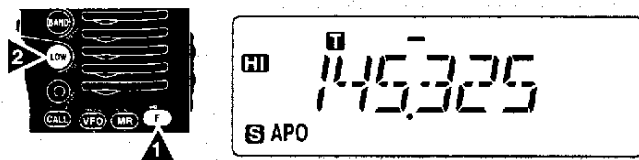

6

Note: You cannot use the Tone and CTCSS functions simultaneously. Switching the Tone function ON after activating the CTCSS deactivates the CTCSS.

TH-G71E only: When you access repeaters that require 1750 Hz tones, you need not activate the Tone function. No matter which selection you make here, pressing [LOW] while pressing the PTT switch or simply pressing [LOW] causes the transceiver to transmit 1750 Hz tones.

■ Selecting a Tone Frequency

- 1 Select the desired band.
- 2 Press [F], [LOW] to activate the Tone function.
 - "T" appears.
- 3 Press [F], [9].
 - The current tone frequency appears and blinks.

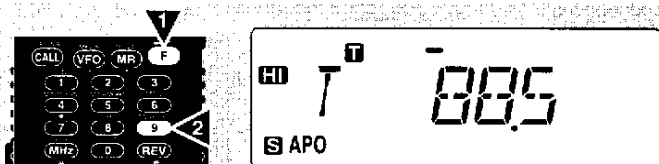

- 4 Turn the **Tuning** control to select a tone frequency.
- 5 Press any key other than [LAMP] and [MONI] to complete the setting.

Freq. (Hz)	Freq. (Hz)	Freq. (Hz)	Freq. (Hz)
67.0	97.4	136.5	192.8
71.9	100.0	141.3	203.5
74.4	103.5	146.2	210.7
77.0	107.2	151.4	218.1
79.7	110.9	156.7	225.7
82.5	114.8	162.2	233.6
85.4	118.8	167.9	241.8
88.5	123.0	173.8	250.3
91.5	127.3	179.9	
94.8	131.8	186.2	

TH-G71E only: To transmit 1750 Hz tones, press and hold the PTT switch, then press [LOW], or simply press and hold [LOW]. Releasing [LOW] quits transmitting 1750 Hz tones.

■ Automatic Repeater Offset (U.S.A./ Canada/ Europe Only)

This function automatically selects an offset direction and activates the Tone function, according to the frequency that you select on the VHF band. The transceiver is programmed for offset direction as shown below. To obtain an up-to-date band plan for repeater offset direction, contact your national Amateur Radio association.

U.S.A. and Canada versions

This complies with the standard ARRL band plan.

144.0 145.5 146.4 147.0 147.6
145.1 146.0 146.6 147.4 148.0 MHz

S	-	S	+	S	-	+	S	-
---	---	---	---	---	---	---	---	---

S: Simplex

European versions

144.0 145.6 145.8 146.0 MHz

S	-	S
---	---	---

S: Simplex

Note: Automatic Repeater Offset does not function when Reverse is ON. However, pressing [REV] after Automatic Repeater Offset has selected an offset (split) status, exchanges the receive and transmit frequencies.

- 1 Press [F], [BAND] to enter Menu mode.
- 2 Select Menu No. 7 (ARO).



- 3 Press [BAND] to switch the function ON (default) or OFF.

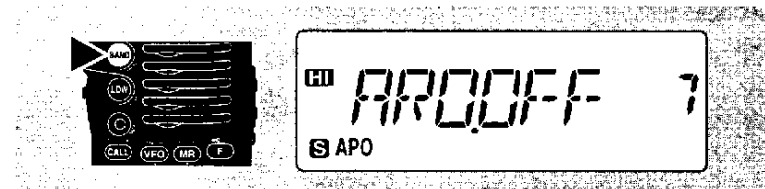

- 4 Press any key other than [BAND], [LAMP], and [MONI] to exit Menu mode.

6

REVERSE FUNCTION

When used while monitoring a repeater, the Reverse function allows you to manually check the signal strength of a station accessing the repeater. If the station's signal is strong, it is best to move to a simplex frequency to continue the contact and free up the repeater.

Press **[REV]** to switch the Reverse function ON (or OFF).

- The receive frequency and the transmit frequency are exchanged.
- "R" appears when the function is ON.

6

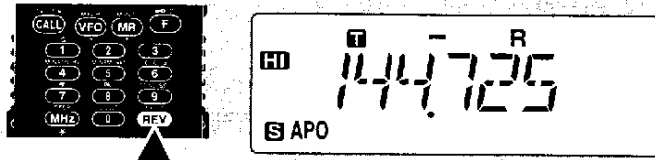

Note:

- ◆ If pressing **[REV]** places the transmit frequency outside the allowable transmit frequency range, an error beep sounds when **[PTT]** is pressed, and transmission is inhibited.
- ◆ If reversal would place the receive frequency outside the receive frequency range, an error beep sounds when **[REV]** is pressed. No reversal occurs.
- ◆ Automatic Repeater Offset does not function while Reverse is ON.
- ◆ You cannot switch Reverse ON or OFF while transmitting.

MEMORY CHANNELS

In memory channels, you can store frequencies and related data that you often use. Then you need not reprogram those data every time. You can quickly recall wanted channels by simple operation. A total of 200 memory channels are available for VHF and UHF.

You can also store a name for each memory channel. For more information, see "NAMING MEMORY CHANNELS" {page 20}.

SIMPLEX OR SPLIT MEMORY CHANNEL?

There are 2 methods of storing transmit/receive frequencies and related data in memory channels, depending on the relationship of the transmit and receive frequencies. You can use each memory channel either as a simplex channel or split channel. Use as a split channel to store a separate receive and transmit frequency.

- Simplex memory channels:
Receive frequency = Transmit frequency
- Split memory channels:
Receive frequency \neq Transmit frequency

Note: Not only can you store data in memory channels, but you can also overwrite existing data with new data.

The data listed below can be stored in each memory channel:

Parameter	Simplex Channel	Split Channel
Receive frequency	Yes	Yes
Transmit frequency		Yes
Tone frequency	Yes	Yes
Tone ON/OFF	Yes	Yes
CTCSS frequency	Yes	Yes
CTCSS ON/OFF	Yes	Yes
Frequency step size	Yes	Yes
Offset direction	Yes	N/A
Offset frequency	Yes	N/A
Reverse ON/OFF	Yes	N/A
Memory channel lockout	Yes	Yes
Memory channel name	Yes	Yes
AM/FM mode selection (U.S.A./Canada only)	Yes	Yes

Yes: Can be stored in memory.

N/A: Not applicable

STORING DATA IN SIMPLEX CHANNELS

- 1 Select the desired band.
- 2 Select the desired frequency and related data (Tone, CTCSS, etc.) using VFO mode, Memory Recall {page 19}, or the Call channel {page 21}.
- 3 Press [F].
 - A memory channel number appears and blinks.
 - A triangle icon appears below the memory channel number when the current channel contains data.

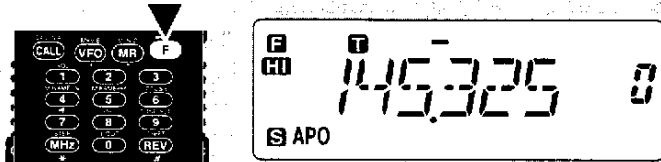

- 4 Turn the **Tuning** control to select the desired memory channel.
- 5 Press [MR].
 - The selected frequency and related data are stored in the memory channel.
 - If the memory channel selected in the previous step already contained data, the new data overwrites the previous data.

STORING DATA IN SPLIT CHANNELS

- 1 To store the desired receive frequency and related data, use steps 1 to 5 given for Simplex Memory Channels.
- 2 Select the desired transmit frequency.
- 3 Press [F].
- 4 Turn the **Tuning** control to select the memory channel that you selected in step 1.
- 5 Press [PTT]+[MR].
 - The selected transmit frequency is stored in the memory channel.

Note:

- ◆ If you selected an offset direction in step 1, you can also press [REV] in step 2 to select a transmit frequency. The transmit frequency separated by the current offset frequency will be stored in the memory channel.
- ◆ Transmit Offset status and Reverse status are not stored in a split memory channel.
- ◆ To store data other than frequencies, select the data in step 1, not step 2.

RECALLING MEMORY CHANNELS

- 1 Press [MR] to enter Memory Recall mode.
 - The memory channel used last is recalled.

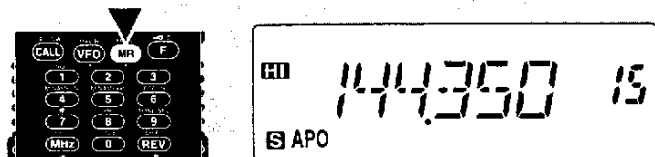

- 2 Turn the **Tuning** control to select the desired memory channel.
 - You cannot recall empty memory channels.
 - To restore VFO mode, press [VFO].

You may want to recall only memory channels that store frequencies of the current band. Access Menu No. 2 (MR) to select "ONE". The default is "ALL".

ONE: Recalls only memory channels of the current band.

ALL: Recalls all programmed memory channels. For example, allows you to recall a VHF frequency channel when operating the UHF band.

Note:

- ◆ You can also recall memory channels by directly entering numeric keys. See "Memory Channel Number Entry" (page 40).
- ◆ When you recall a split memory channel, "+" and "-" appear on the display. Press [REV] to display the transmit frequency.
- ◆ After recalling a memory channel, you may program data such as Tone or CTCSS. These settings, however, are cleared once you select another channel or the VFO mode. To permanently store the data, overwrite the channel contents (page 18).

CLEARING MEMORY CHANNELS

- 1 Recall the desired memory channel.
- 2 Switch OFF the power to the transceiver.
- 3 Press [MR]+ POWER ON.
 - A confirmation message appears.



- 4 Press [MR] again.
 - The contents of the selected memory channel are erased.



NAMING MEMORY CHANNELS

You can name memory channels using up to 6 alphanumeric characters. When you recall a named memory channel, its name appears on the display instead of the stored frequency. Names can be callsigns, repeater names, cities, names of people, etc.

Note: You can also name the Program Scan and Priority channels, but you cannot name the Call channel.

- 1 Recall the desired memory channel.
- 2 Press **[F]**, **[4]** to enter Memory Naming mode.
 - The first digit blinks.

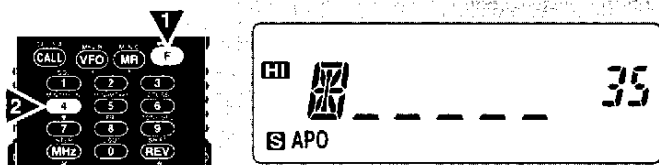

- 3 Turn the **Tuning** control to select the first digit.
 - You can select "0" to "9", "A" to "Z", "-", "/", or a space.
- 4 Press **[MR]**.
 - The second digit blinks.

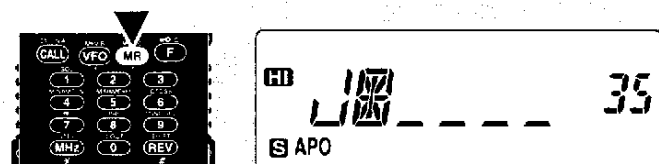

- 5 Repeat steps 3 and 4 to enter up to 6 digits.
 - After selecting the 6th digit, you need not press **[MR]**.
 - To erase and re-enter the preceding digits, press **[VFO]** as many times as required.
- 6 Press **[F]** to complete the setting.

Note:

- ◆ Names can be assigned only to memory channels in which you have stored frequencies and related data.
- ◆ The stored names can be overwritten by repeating steps 1 to 6.
- ◆ The stored names can be erased by repeatedly pressing **[VFO]** in step 2 then pressing **[F]**.
- ◆ The stored names also are erased by clearing memory channels.

SWITCHING MEMORY NAME/ FREQUENCY DISPLAY

After storing memory names, you can switch the display between memory names and frequencies. You may sometimes want to confirm frequencies stored in named memory channels.

- 1 Press **[MR]** to enter Memory Recall mode.
- 2 Press **[F]**, **[5]** to switch between memory name and frequency display.



CALL CHANNEL

The Call channel can be used to store any frequency and related data that you will recall often. The Call channel also can be programmed either as a simplex or split channel. No matter what mode the transceiver is in, the Call channel can always be selected quickly. You may want to dedicate the Call channel as an emergency channel within your group. In this case, the Call/VFO scan {page 29} will be useful.

The default frequency stored in the Call channel is shown below:

Version	VHF	UHF
U.S.A./ Canada	144.000 MHz	440.000 MHz
Europe/ General	144.000 MHz	430.000 MHz

The contents of the Call channel cannot be deleted; however, you can overwrite old data with new data as described in the following section.

■ Recalling the Call Channel

- 1 Select the desired band.
- 2 Press **[CALL]** to recall the Call channel.
 - “C” appears.

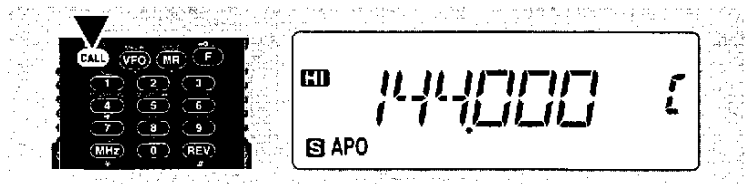

- To restore the previous mode, press **[CALL]** again.

■ Changing Call Channel Contents

- 1 Select the desired band.
- 2 Select the desired frequency and related data (Tone, CTCSS, etc.) using VFO mode or Memory Recall {page 19}.
 - When you program the Call channel as a split channel, select a receive frequency.
- 3 Press **[F]**, **[CALL]**.
 - The selected frequency and related data are stored in the Call channel.
 - The previous mode is restored.

To also store a transmit frequency, proceed to the next step.

- 4 Select the desired transmit frequency.
- 5 Press **[F]**.
- 6 Press **[PTT]+[CALL]**.
 - The selected transmit frequency is stored in the Call channel, and the previous mode is restored.

Note:

- ◆ Transmit Offset status and Reverse status are not stored in a split Call channel.
- ◆ Lockout status and memory names are not copied from a memory channel to the Call channel.
- ◆ To store data other than frequencies, select the data in step 2, not step 4.

MEMORY → VFO TRANSFERS

Transferring the contents of a memory channel or the Call channel to the VFO can be useful if you want to search for other stations or a clear frequency, near the selected memory channel or Call channel frequency.

- 1 Recall the desired memory channel or the Call channel.
- 2 Press [F], [VFO].
 - The entire contents of the memory channel or the Call channel are copied to the VFO. VFO mode is selected after the transfer is completed.

Note:

- ◆ A transmit frequency from a split memory channel or split Call channel is not transferred to the VFO. To transfer a transmit frequency, press [REV], then press [F], [VFO].
- ◆ Lockout status and memory names are not copied from a memory channel to the VFO.
- ◆ If you recall the Call channel in step 1, simply turning the **Tuning** control also transfers the contents to the VFO. The frequency, however, is changed by one step.

CHANNEL DISPLAY FUNCTION

When this function is switched ON, the transceiver displays only a memory channel number instead of a frequency.

Press [BAND]+ POWER ON to switch this function ON (or OFF).

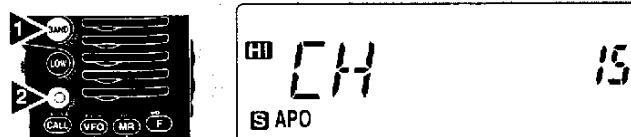

When in Channel Display mode, you cannot use the following functions:

- Band Select
- Call Channel Recall
- Memory Name Store
- Memory → VFO Transfer
- Call Channel Store
- Call/ Memory Scan
- VFO Select
- Memory Channel Store
- Memory Channel Clear
- Memory Name/ Frequency Display Switch
- Priority Scan
- Partial/ Full Reset

Note:

- ◆ You cannot switch this function ON if you have stored frequencies in no memory channels.
- ◆ When in Channel Display mode, you may want to recall only memory channels of the desired band. Before pressing [BAND]+ POWER ON, select "ONE" in Menu No. 2 (MR), then select the desired band.

INITIALIZING MEMORY

If your transceiver seems to be malfunctioning, initializing the transceiver may resolve the problem.

Remember that you need to re-program memory channels after initialization. On the other hand, initialization is a quick way to clear all memory channels.

Note: While using the Channel Display or Transceiver Lock function, you cannot do Partial Reset nor Full Reset.

VHF Band Defaults

Version	VFO Frequency	Frequency Step	Tone Frequency
U.S.A./ Canada	144.000 MHz	5 kHz	88.5 Hz
Europe/ General	144.000 MHz	12.5 kHz	88.5 Hz

UHF Band Defaults

Version	VFO Frequency	Frequency Step	Tone Frequency
U.S.A./ Canada	440.000 MHz	25 kHz	88.5 Hz
Europe/ General	430.000 MHz	25 kHz	88.5 Hz

■ Partial Reset (VFO)

Use to initialize all settings except the memory channels, the Call channel, the DTMF channels, and Memory Channel Lockout.

1 Press [VFO]+ POWER ON.

- A confirmation message appears.

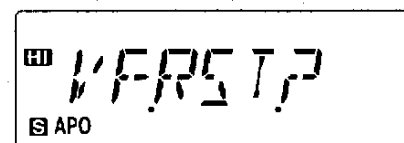
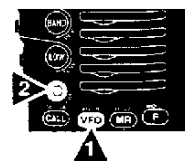

- To quit resetting, press any key other than [VFO].

2 Press [VFO] again.

■ Full Reset (Memory)

Use to initialize all settings.

1 Press [F]+ POWER ON.

- A confirmation message appears.

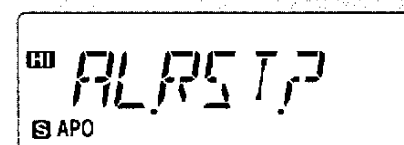
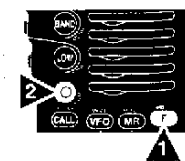

- To quit resetting, press any key other than [F].

2 Press [F] again.

7

SCAN

Scan is a useful feature for hands-off monitoring of your favorite frequencies. After becoming comfortable with how to use all types of Scan, the monitoring flexibility gained will increase your operating efficiency.

This transceiver provides the following conventional scans in addition to "Priority Scan" {page 30} that may be new to you:

Scan Type	Scan Range
VFO Scan	All frequencies tunable on the band
Memory Scan	Frequencies stored in the memory channels
MHz Scan	All frequencies within 1 MHz range
Program Scan	All frequencies in the range selected on the band
Call/VFO Scan	Call channel plus the current VFO frequency
Call/Memory Scan	Call channel plus the memory channel last used

8

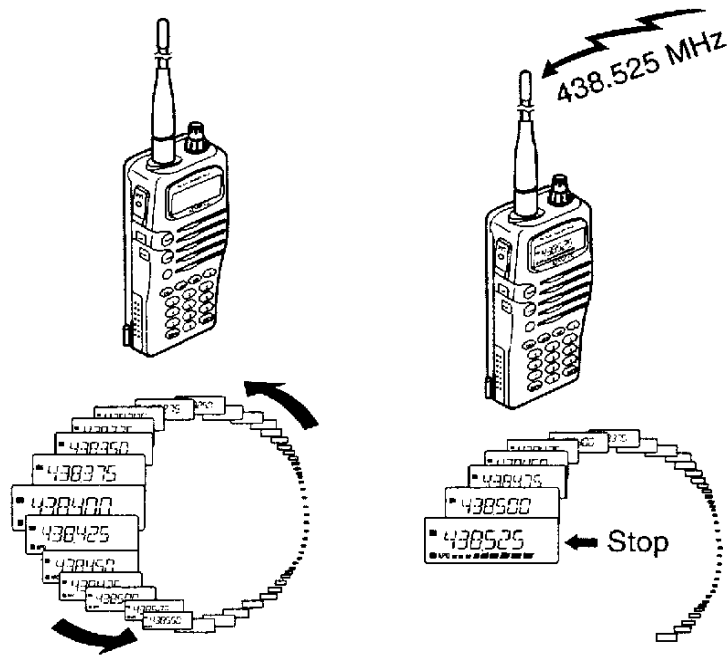

Note:

- ◆ Remember to adjust the squelch threshold level before using Scan.
- ◆ You cannot start Scan while Tone Alert is ON.
- ◆ While using CTCSS, Scan stops for any signal received; however, the squelch opens only for signals that contain the same CTCSS tone that is selected on your transceiver.

SCAN RESUME METHODS

Before using Scans other than Priority Scan, it's necessary to decide under what condition you want your transceiver to continue scanning after detecting and stopping for a signal. You can choose one of the following modes. The default is Time-Operated mode.

- **Time-Operated mode**

Your transceiver stops scanning when detecting a signal, remains there for approximately 5 seconds, and then continues to scan even if the signal is still present.

- **Carrier-Operated mode**

Your transceiver stops scanning when detecting a signal and remains on the same frequency until the signal drops out. There is a 2 second delay between signal drop-out and scan resumption to allow time for any responding stations to begin transmitting.

- **Seek mode**

Your transceiver stops scanning when detecting a signal and remains on the same frequency; the transceiver stays on this frequency even after the signal drops out and does not automatically resume scanning.

Note: Pressing and holding **[MONI]** causes the transceiver to stop scanning; releasing **[MONI]** causes it to resume scanning.

■ Selecting Scan Resume Method

- 1 Press **[F]**, **[BAND]** to enter Menu mode.
- 2 Select Menu No. 1 (SCAN).

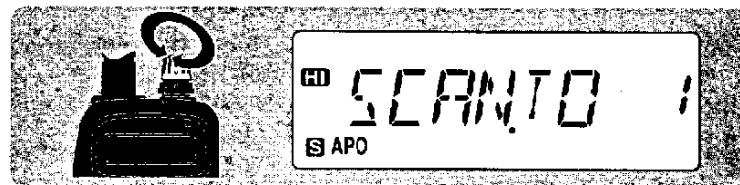

- 3 Press **[BAND]** to select Time-Operated (TO), Carrier-Operated (CO), or Seek (SE) mode.
- 4 Press any key other than **[BAND]**, **[LAMP]**, and **[MONI]** to exit Menu mode.

VFO SCAN

VFO Scan allows you to scan all frequencies from the lowest frequency to the highest frequency on the band. The current frequency step size {page 40} is used.

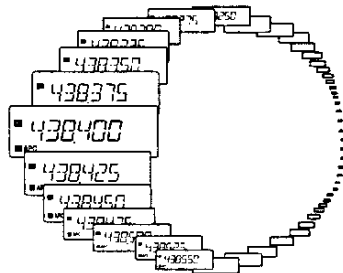

1 Select the desired band.

2 Press [VFO] (1 s).

8

- The 1 MHz decimal blinks while scanning is in progress.
- Scan starts at the frequency currently displayed.
- To reverse the scan direction, turn the **Tuning** control clockwise (upward scan) or counterclockwise (downward scan).

3 To quit VFO Scan, press any key other than [LAMP], [MONI], and [F].

Note: The squelch must be closed for Scan to function.

MEMORY SCAN

Memory Scan allows all memory channels containing data to be scanned.

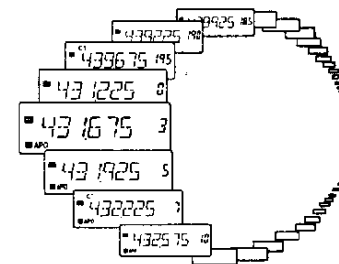

1 Press [MR] (1 s).

- The 1 MHz decimal blinks while scanning is in progress.
- Scan starts with the channel last recalled.
- To reverse the scan direction, turn the **Tuning** control clockwise (upward scan) or counterclockwise (downward scan).

2 To quit Memory Scan, press any key other than [LAMP], [MONI], and [F].

Note:

- ◆ At least 2 or more memory channels must contain data and must not be locked out.
- ◆ The squelch must be closed for Scan to function.
- ◆ The L0 to L9 and U0 to U9 memory channels and the priority channel are not scanned.
- ◆ You can also start Memory Scan when in Channel Display mode. While Scan is being interrupted, the channel number blinks.
- ◆ If you select "ONE" using Menu No. 2 (MR), memory channels on only the current band will be scanned; otherwise, memory channels on both VHF and UHF bands will be scanned.

■ Locking Out Memory Channels

Memory channels that you prefer not to monitor while scanning can be locked out.

- 1 Recall the desired memory channel.
- 2 Press [F], [0] to switch Lockout ON (or OFF).
 - A star appears below the memory channel number to indicate that the channel has been locked out.

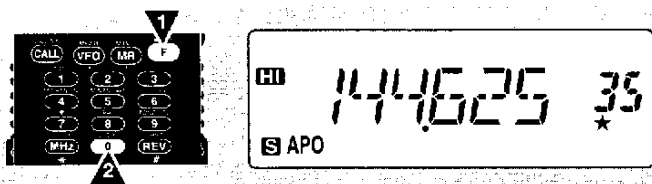

Note: The L0 to L9 and U0 to U9 memory channels and the priority channel cannot be locked out.

MHz SCAN

MHz Scan allows you to scan a 1 MHz segment of the band. The current 1 MHz digit determines the limits of the scan. For example, if the current frequency is 438.400 MHz, then MHz Scan would scan from 438.000 MHz to 438.975 MHz. The exact upper limit depends on the step size selected.

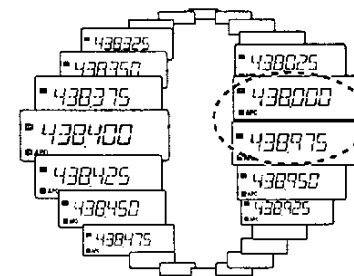
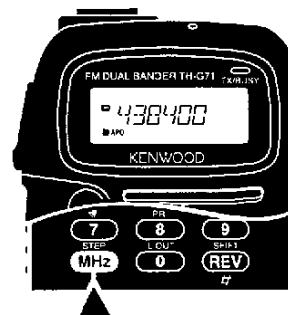

- 1 Press [VFO] to select VFO mode.
- 2 Select the desired band.
- 3 Press [MHz] (1 s) to start MHz Scan.
 - The 1 MHz decimal blinks while scanning is in progress.
 - Scan starts at the frequency currently displayed.
 - To reverse the scan direction, turn the **Tuning** control clockwise (upward scan) or counterclockwise (downward scan).
- 4 To quit MHz Scan, press any key other than [LAMP], [MONI], and [F].

8

PROGRAM SCAN

Program Scan is similar to VFO Scan except that you select the frequency range of the scan.

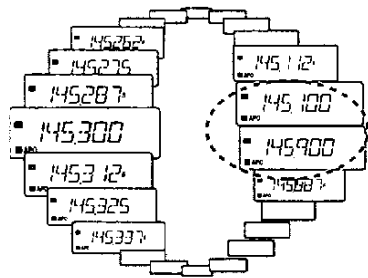
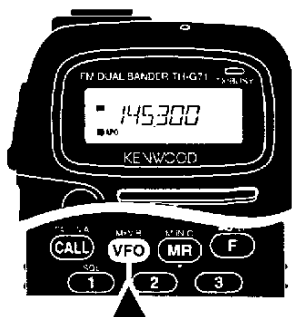

■ Setting Scan Limits

You can store up to 10 scan ranges in memory channels L0/U0 to L9/U9.

8

- 1 Select the desired band.
- 2 Turn the **Tuning** control to display the desired lower limit.
- 3 Press **[F]**.
- 4 Turn the **Tuning** control to select a channel in the range L0 to L9.

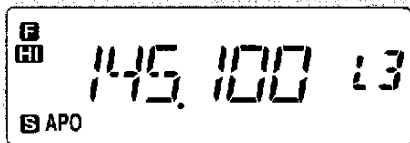

- 5 Press **[MR]**.
 - The lower limit is stored in the channel.
- 6 Turn the **Tuning** control to display the desired upper limit.
- 7 Press **[F]**.
- 8 Turn the **Tuning** control to select a matching channel in the range U0 to U9.
 - If you have selected for example L3 in step 4, select U3.



- 9 Press **[MR]**.
 - The upper limit is stored in the channel.
- 10 To confirm the stored scan limits, press **[MR]**, then select the L and U channels.

Note:

- ◆ The lower limit must be lower in frequency than the upper limit.
- ◆ The lower and upper frequency steps must be equal.
- ◆ The lower and upper limits must be selected on the same band.

■ Using Program Scan

- 1 Press **[VFO]** to select VFO mode.
- 2 Select the desired band.
- 3 Select a frequency equal to or between the programmed scan limits.
- 4 Press **[VFO]** (1 s).
 - The 1 MHz decimal blinks while scanning is in progress.
 - Scan starts at the frequency currently displayed.
 - To reverse the scan direction, turn the **Tuning** control clockwise (upward scan) or counterclockwise (downward scan).
- 5 To quit Program Scan, press any key other than **[LAMP]**, **[MONI]**, and **[F]**.

Note:

- ◆ *The squelch must be closed for Scan to function.*
- ◆ *If the frequency step of the current VFO frequency differs from that of the programmed frequencies, you cannot use Program Scan.*
- ◆ *If the frequency steps of the lower limit and upper limit differ, you cannot use Program Scan.*
- ◆ *If the current VFO frequency is within more than one programmed scan range, the range stored in the smallest channel numbers is used.*

CALL/VFO SCAN

Use Call/VFO Scan to monitor both the Call channel and the current VFO frequency on the selected band.

- 1 Press **[VFO]** to select VFO mode.
- 2 Select the desired band.
- 3 Select the desired frequency.
- 4 Press **[CALL]** (1 s) to start Call/VFO Scan.
 - The 1 MHz decimal blinks while scanning is in progress.
- 5 To quit Call/VFO Scan, press any key other than **[LAMP]**, **[MONI]**, and **[F]**.

CALL/MEMORY SCAN

Use Call/Memory Scan to monitor both the Call channel and the desired memory channel.

- 1 Recall the desired memory channel.
- 2 Press **[CALL]** (1 s) to start Call/Memory Scan.
 - The 1 MHz decimal blinks while scanning is in progress.
 - The Call channel on the same band as of the selected memory channel is used for Scan.
- 3 To quit Call/Memory Scan, press any key other than **[LAMP]**, **[MONI]**, and **[F]**.

Note: *The memory channel last used is scanned even if it has been locked out.*

PRIORITY SCAN

You may sometimes want to monitor your favorite frequency on one band while operating on another band. Use Priority Scan. This Scan always monitors your favorite frequency in the background. When receiving signals on your specific frequency, the transceiver immediately recalls that frequency on the display and allows you to use it for QSO. First store your favorite frequency in the Priority channel and select one of the two Priority Scan methods.

Note: If you do not operate any control or key for 3 seconds after signals drop, the transceiver resumes Priority Scan.

8

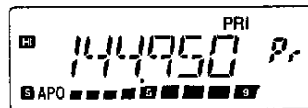
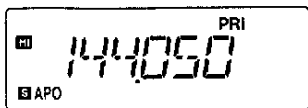
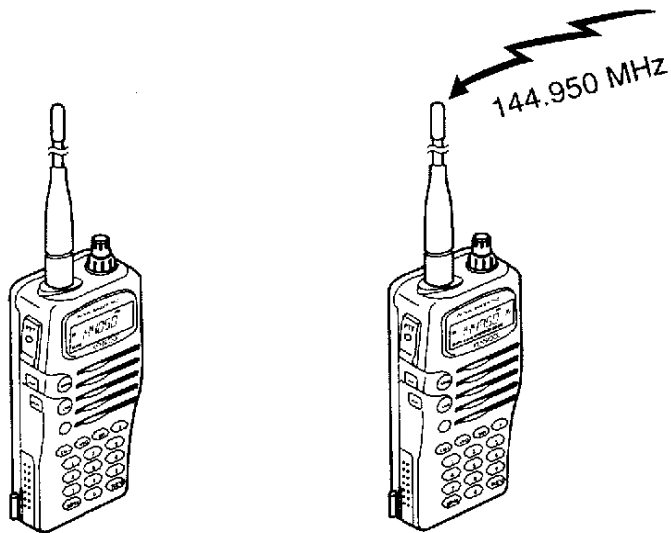

■ Storing Frequency in Priority Channel

- 1 Select the desired band.
- 2 Select the desired frequency.
- 3 Press [F].
 - A memory channel number appears and blinks.
- 4 Turn the **Tuning** control to select the Priority channel.
 - “Pr” appears when you select the Priority channel.

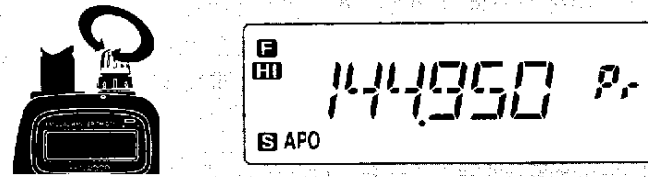

- 5 Press [MR].

Note: Not only can you store data in the Priority channel, but you can also overwrite existing data with new data.

■ Selecting Priority Scan Method

This transceiver prepares the following two modes for Priority Scan. Use mode B when you do not want Priority Scan to disrupt your current QSO.

Mode A: Monitors the Priority channel every 3 seconds no matter whether or not signals are being received on the current operating frequency.

Mode B: Monitors the Priority channel every 3 seconds only when no signals are present on the current operating frequency.

- 1 Press **[F]**, **[BAND]** to enter Menu mode.
- 2 Select Menu No. 11 (PRI).

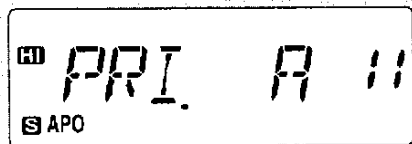

- 3 Press **[BAND]** to select mode A (default) or mode B.

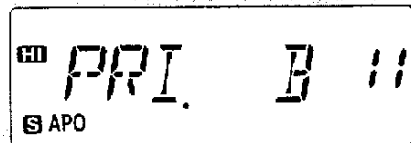
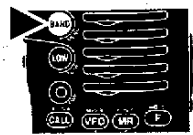

- 4 Press any key other than **[BAND]**, **[LAMP]**, and **[MONI]** to exit Menu mode.

■ Using Priority Scan

- 1 Press **[F]**, **[8]** to activate Priority Scan.
 - "PRI" appears.



- When signals are received on the Priority channel, a beep sounds and the Priority channel frequency appears. In addition, "Pr" appears and blinks.

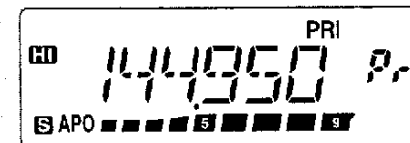

- 2 Press the **PTT** switch to transmit on the Priority channel and release the **PTT** switch to receive.

- Approximately 3 seconds after signals drop, Priority Scan resumes.

- 3 To quit Priority Scan, press **[F]**, **[8]** again.

Note:

- ◆ When signals are received on the Priority channel programmed with CTCSS, the Priority channel is recalled; however, the squelch does not open unless the signals contain the matching CTCSS tone.
- ◆ You can simultaneously use Priority Scan and any other type of Scan; however Priority Scan does not function while the other scan is being paused.
- ◆ Pressing and holding **[MONI]** while using Priority Scan allows you to monitor the current operating frequency; releasing **[MONI]** resumes Priority Scan.

CONTINUOUS TONE CODED SQUELCH SYSTEM (CTCSS)

You may sometimes want to hear calls from only specific persons. The Continuous Tone Coded Squelch System (CTCSS) allows you to ignore (not hear) unwanted calls from other persons who are using the same frequency. Simply select the same CTCSS tone as selected by the other persons in your group. A CTCSS tone is subaudible and is selectable from among the 38 standard tone frequencies.

Note: CTCSS does not cause your conversation to be private. It only relieves you of listening to unwanted conversations.

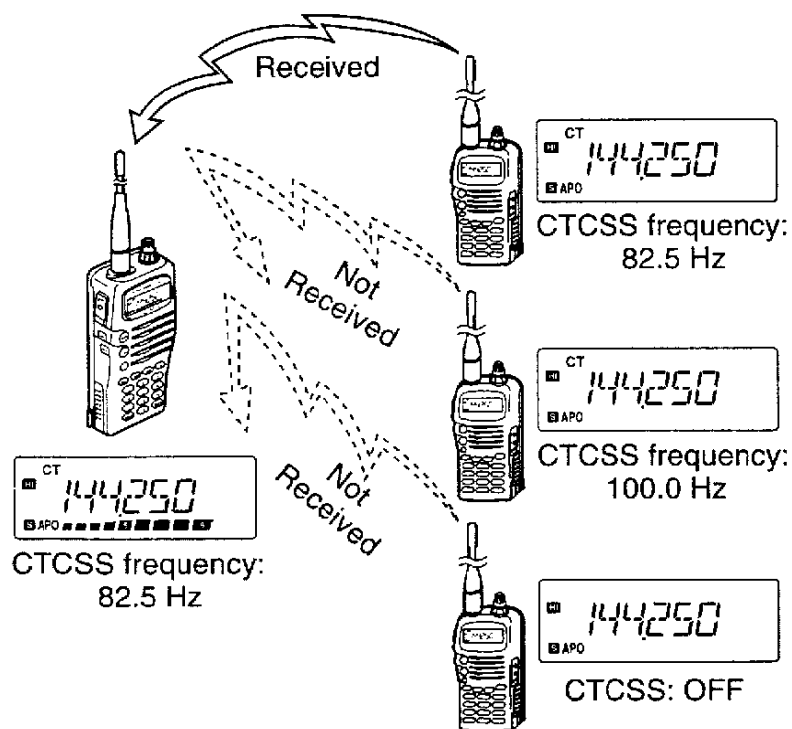

USING CTCSS

- 1 Select the desired band.
- 2 Press [F], [6] to switch the CTCSS function ON (or OFF).
 - "CT" appears when CTCSS is ON.

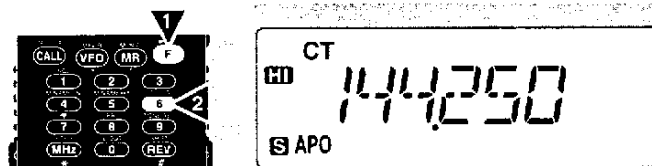

- 3 Press [F], [9].
 - The current CTCSS frequency appears and blinks.

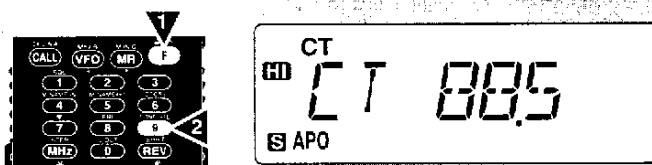

- 4 Turn the **Tuning** control to select a tone frequency.
- 5 Press any key other than [LAMP] and [MONI] to complete the setting.
- 6 **When you are called:**

The squelch of your transceiver opens only when the selected tone is received.

When you make a call:

Press and hold [PTT].

Note:

- ◆ Skip steps 3 to 5 if you have already programmed the appropriate CTCSS frequency.
- ◆ You can select a separate tone frequency for the CTCSS and Tone functions.
- ◆ You cannot use the CTCSS and Tone functions simultaneously. Switching the CTCSS function ON after activating the Tone function deactivates the Tone function.
- ◆ If you select a high tone frequency, receiving audio or noise that contains the same frequency portions may cause CTCSS to function incorrectly. To prevent noise from causing this problem, select an appropriate noise squelch level (page 8).

Freq. (Hz)	Freq. (Hz)	Freq. (Hz)	Freq. (Hz)
67.0	97.4	136.5	192.8
71.9	100.0	141.3	203.5
74.4	103.5	146.2	210.7
77.0	107.2	151.4	218.1
79.7	110.9	156.7	225.7
82.5	114.8	162.2	233.6
85.4	118.8	167.9	241.8
88.5	123.0	173.8	250.3
91.5	127.3	179.9	
94.8	131.8	186.2	

■ **Automatic Tone Frequency ID**

This function automatically identifies the incoming tone frequency on a received signal.

- 1 Select the desired band.
- 2 Press [F], [6] (1 s) to activate the function.
 - The current tone frequency appears and the 1 Hz decimal blinks.

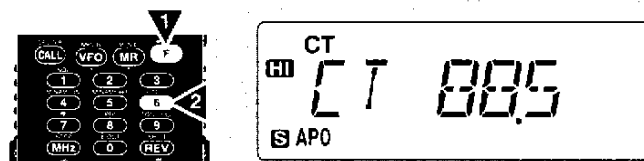

- When a signal is received, the transceiver begins scanning through all tone frequencies in order to identify the incoming tone frequency.
- When the tone frequency is identified, the identified frequency appears and blinks. To continue scanning, turn the **Tuning** control.

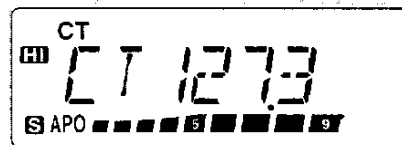

- The identified frequency is programmed in place of the currently set CTCSS frequency.
- 3 Press any key other than [LAMP] and [MONI] to quit the function.

Note: Received signals are audible while scanning is in progress.

DUAL TONE MULTI-FREQUENCY (DTMF) FUNCTIONS

You can send DTMF tones by using the DTMF keys on the keypad. The keypad includes the 12 keys found on a push-button telephone plus 4 additional keys (A, B, C, D). These additional keys are required for various control operations by some repeater systems.

MAKING DTMF CALLS

- 1 Press and hold the **PTT** switch.
- 2 Press the keys in sequence on the keypad to send DTMF tones.
 - The corresponding DTMF tones are transmitted.

Freq. (Hz)	1209	1336	1477	1633
697	1	2	3	A (CALL)
770	4	5	6	B (VFO)
852	7	8	9	C (MR)
941	* (MHz)	0	# (REV)	D (F)

10

■ DTMF Tone TX Hold

This function makes the transceiver remain in the transmit mode for 2 seconds after you release each key. So you can release the **PTT** switch after beginning to press keys.

- 1 Press **[F]**, **[BAND]** to enter Menu mode.
- 2 Select Menu No. 13 (2S).

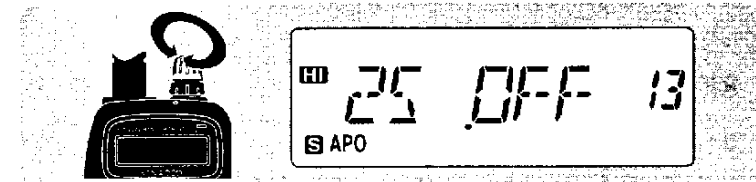

- 3 Press **[BAND]** to switch the function ON or OFF (default).
- 4 Press any key other than **[BAND]**, **[LAMP]**, and **[MONI]** to exit Menu mode.

■ Autopatch (U.S.A. and Canada)

Some repeaters in the U.S.A. and Canada offer a service called Autopatch. Autopatch allows you to access the public telephone network by sending DTMF tones. Some repeaters require a special key sequence to activate Autopatch. Check with the repeater control operator.

STORING DTMF NUMBERS FOR AUTOMATIC DIALER

To store a DTMF number with a maximum of 16 digits in any of 10 dedicated DTMF memory channels, follow the procedure below.

Note: Audible DTMF tones from other transceivers near you may be picked up by your microphone. If so, this could prevent the function from working correctly.

- 1 Press [**F**], [**BAND**] to enter Menu mode.
- 2 Select Menu No. 10 (DTMFMR).

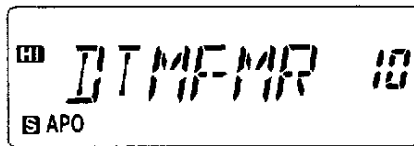

- 3 Press [**BAND**].
 - The display for entering a DTMF number appears.

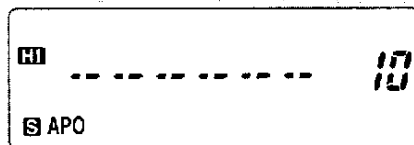
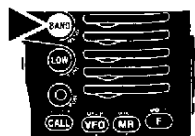

- 4 Use the keypad to enter the digits of the number to be stored.
 - The corresponding DTMF tones are heard.
 - If you enter incorrect digits, press [**LOW**] to erase all digits entered.

- 5 Press [**BAND**] to complete entry.
 - The display for entering a channel number appears.

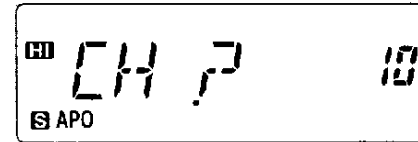
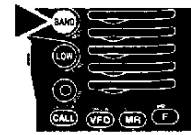

- 6 Press a single key [**0**] to [**9**] to select the desired channel.
 - The entered number is stored in the selected channel.
- 7 Press any key other than [**BAND**], [**LAMP**], [**MONI**], and [**0**] to [**9**] to exit Menu mode.

CONFIRMING STORED DTMF NUMBERS

- 1 Press [**F**], [**BAND**] to enter Menu mode.
- 2 Select Menu No. 10 (DTMFMR).

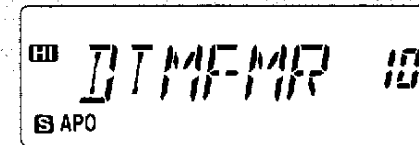

- 3 Press a single key [**0**] to [**9**] to select the desired channel.
 - The number stored in the channel scrolls across the display accompanied by DTMF tones from the speaker.
- 4 Press any key other than [**BAND**], [**LAMP**], [**MONI**], and [**0**] to [**9**] to exit Menu mode.

TRANSMITTING STORED DTMF NUMBERS

To transmit a stored DTMF number, follow the procedure below.

1 Press [PTT]+[BAND].

- The first 4 DTMF digits of the channel used last and the channel number appear.

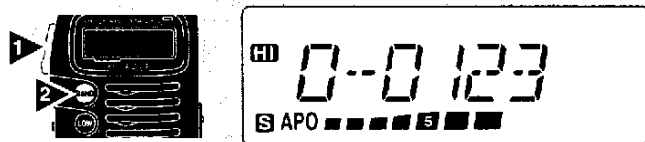

2 Release only [BAND], then press [0] to [9] to select the desired channel.

- The number stored in the channel scrolls across the display accompanied by DTMF tones from the speaker.
- After the transmission, the frequency display is restored.

Note: In step 2 you may forget the channel number you should select. After releasing only [BAND], turn the **Tuning** control to find the desired channel, then press [BAND] again. While turning the **Tuning** control, you will confirm the first 4 digits stored in each channel.

AUXILIARY FUNCTIONS

TX INHIBIT

You can disable the TX function to prevent unauthorized individuals from transmitting, or to eliminate the risk of accidentally transmitting by yourself.

Access Menu No. 12 (TXS) to switch TX Inhibit ON or OFF (default).

- Pressing the **PTT** switch after switching TX Inhibit ON causes the transceiver to generate an error beep and display “TXSTOP”.

TRANSCEIVER LOCK

This function prevents unauthorized individuals from changing the transceiver settings.

Press **[F] (1 s)** to switch the function ON (or OFF).

- A key icon appears when the function is ON.

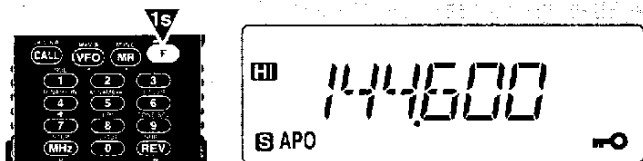

You may want to use the **Tuning** control when in Transceiver Lock mode. Access Menu No. 9 (ENC) to switch the Tuning Control Enable function ON or OFF (default).

AUTOMATIC POWER OFF (APO)

Automatic Power Off is a background function that monitors whether any keys have been pressed, or whether any control has been turned. After 1 hour passes with no operations, APO turns OFF the power. However, 1 minute before the power turns OFF, “APO” blinks and a series of warning tones sound.

Access Menu No. 5 (APO) to switch the function ON (default) or OFF.

Note:

- ◆ If the squelch opens or any settings are changed during the 1 hour period while APO is ON, the timer resets. When the squelch closes or you stop changing the settings, the timer begins counting again from 0.
- ◆ The APO timer does not operate while Tone Alert or any scan other than Priority Scan is being used.

BATTERY SAVER

Battery Saver becomes active when the squelch is closed and no key is pressed for more than 10 seconds. This function becomes passive whenever the squelch is opened or any key is pressed.

Access Menu No. 4 (SAV) to switch the function ON (default) or OFF.

11

LAMP FUNCTION

You can illuminate the transceiver display by pressing [LAMP]. Approximately 5 seconds after releasing [LAMP], the light goes OFF if no other key is pressed. Pressing any key other than [LAMP] while the display is lit restarts the 5 second timer; pressing [LAMP] turns OFF the light immediately.

To latch the light ON, press [F], [LAMP]. The light remains ON until you press [F], [LAMP] again.

BEEP ON/OFF

The transceiver beeps each time you press a key on the keypad. You can also switch this function OFF.

Access Menu No. 6 (BP) to switch the function ON (default) or OFF.

SWITCHING AM/FM MODE (U.S.A./ CANADA ONLY)

Your transceiver can also receive in AM mode.

11

Select the 118 MHz band, then access Menu No. 16 (F/A) to select FM or AM (default).

- A spade icon appears when you select AM mode.



TONE ALERT

Tone Alert provides an audible alarm to indicate when signals are received on the frequency you are monitoring. If used with CTCSS, the transceiver beeps only when receiving the same CTCSS tones as you selected.

Select the desired band, then press [F], [7] to switch Tone Alert ON (or OFF).

- A bell icon appears when Tone Alert is ON.

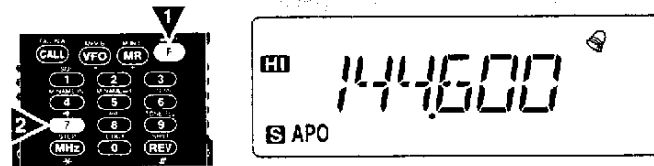

- When receiving correct signals, an alarm sounds and the bell icon starts blinking. Press the PTT switch to quit Tone Alert.
- The display shows the number of hours and minutes elapsed after signals were received. After 99 hours and 59 minutes pass, counting stops. When the next signal was received, the time resets to 00.00 and counting continues. Each time a new signal is received, the time resets to 00.00.

Note:

- ◆ While Tone Alert is ON, there is no speaker output when a signal is received. To hear receive audio, press [MONI].
- ◆ When Tone Alert is ON, APO does not turn the power OFF.
- ◆ When Tone Alert is ON, you can use only the following functions:
 - Lamp ON
 - Lamp Latch ON
 - Monitor
 - Squelch Level Select

PROGRAMMABLE VFO

If you want, you can set limits for the minimum and maximum frequencies that are selectable using the **Tuning** control. For example, if you select 436 MHz for the lower limit and 437 MHz for the upper limit, the tunable range will be from 436.000 MHz to 437.975 MHz.

This function will be useful if you always check frequencies within a certain range.

Note:

- ◆ You cannot program the 100 kHz and subsequent digits.
- ◆ The exact 100 kHz and subsequent digits of the upper limit depend on the step size selected.

- 1 Press [**VFO**] to select VFO mode.
- 2 Select the desired band.
- 3 Press [**F**], [**BAND**] to enter Menu mode.
- 4 Select Menu No. 3 (PROVFO).
- 5 Press [**BAND**], then select the lower frequency limit using the **Tuning** control.

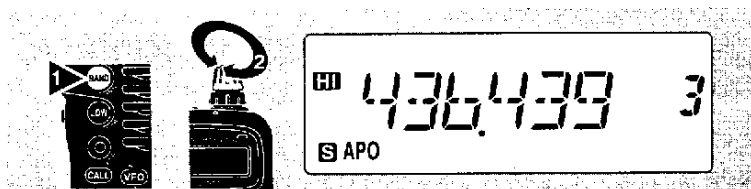

- 6 Press [**BAND**] again, then select the upper frequency limit using the **Tuning** control.

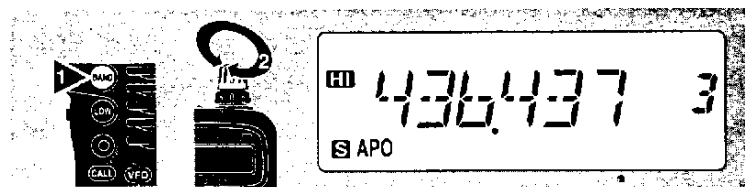

- 7 Press [**BAND**] once again to complete the setting.
- 8 Press any key other than [**BAND**], [**LAMP**], and [**MONI**] to exit Menu mode.

CHANGING SPEAKER CONFIGURATIONS

If using an optional speaker microphone, you can select whether you will hear audio from only the speaker microphone or both the speaker microphone and transceiver. The default is "speaker microphone only".

- 1 Press [**F**], [**BAND**] to enter Menu Mode.
- 2 Select Menu No. 14 (SP).

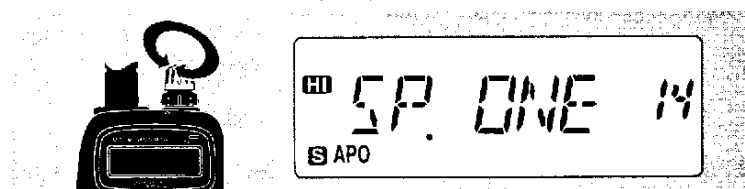

- 3 Press [**BAND**] to select "ONE" (default) or "BOTH".
- 4 Press any key other than [**BAND**], [**LAMP**], and [**MONI**] to exit Menu mode.

KEYPAD DIRECT ENTRY

You can select the desired operating frequency or memory channel by entering digits directly from the keypad. Enter the next digit within 10 seconds.

■ Frequency Entry

- 1 Press **[VFO]** to select VFO mode.
- 2 Select the desired band.
- 3 Press the numeric keys in sequence on the keypad.
 - Enter the digits in order from the most significant down to the least significant.

Note:

- ◆ When the current step size is 5, 10, 15, 20, 25, 30, 50, or 100 kHz, the 1 kHz digit is corrected according to which key is pressed for the 1 kHz digit. Pressing **[0]** ~ **[4]** selects "0" and pressing **[5]** ~ **[9]** selects "5".
- ◆ When the current step size is 6.25 kHz or 12.5 kHz, the 1 kHz and subsequent digits are corrected according to which keys are pressed for the 10 kHz and 1 kHz digits.

■ Memory Channel Number Entry

- 1 Press **[MR]** to enter Memory Recall mode.
 - The memory channel used last is recalled.
- 2 Press the numeric keys to enter a 3-digit memory channel number.
 - To recall channel 3, for example, enter "003".
 - If you enter a memory channel that does not contain data, an error beep sounds.

Note: You cannot recall a Program Scan channel nor the Priority channel with keypad direct entry.

CHANGING FREQUENCY STEP SIZE

Choosing the correct step size is essential in order to select your exact receive frequency using the **Tuning** control. The default step size on the VHF band is 5 kHz (U.S.A./ Canada) or 12.5 kHz (Europe/ General). The default on the UHF band is 25 kHz no matter which market version.

- 1 Press **[VFO]** to select VFO mode.
- 2 Select the desired band.
- 3 Press **[F]**, **[MHz]**.
 - The current step size appears.

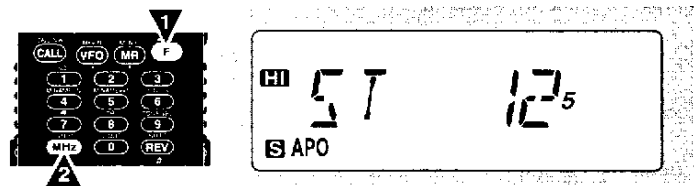

- 4 Turn the **Tuning** control to select the desired step size.
 - The selectable step sizes are 5, 6.25, 10, 12.5, 15, 20, 25, 30, 50, and 100 kHz.
- 5 Press any key other than **[LAMP]** and **[MONI]** to complete the setting.

Note: Changing between step sizes may correct the displayed frequency. For example, if 144.995 MHz is displayed with a 5 kHz step size selected, changing to a 12.5 kHz step size corrects the displayed frequency to 144.9875 MHz.

MICROPHONE CONTROL

After connecting the optional SMC-33 or SMC-34 speaker microphone, you can change numerous transceiver settings without using the transceiver keys or controls. The 1, 2, and 3 keys located on the top of the microphone are programmable with the transceiver key (or key combination) function. The assigned default functions are as follows:

- [1]: Band select
- [2]: VFO/ Memory Recall mode switch
- [3]: Call channel recall (TH-G71E: Transmit power select)

Note:

- ◆ Turn OFF the transceiver power before connecting the optional speaker microphone.
- ◆ If the **LOCK** switch located on the rear of the microphone is ON, you cannot re-program the Programmable Function keys.

1 Press one of the following key combinations depending on which key you want to re-program:

- Mic [1]+ **POWER ON** ("PF 1" appears)
- Mic [2]+ **POWER ON** ("PF 2" appears)
- Mic [3]+ **POWER ON** ("PF 3" appears)

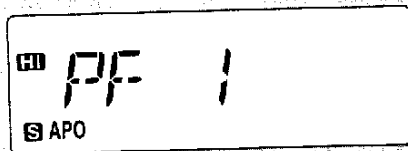

2 Press a key or key combination on the transceiver that you want to assign.

- To assign the Up function, rotate the **Tuning** control clockwise. To assign the Down function, rotate the **Tuning** control counterclockwise.
- Pressing the **PTT** switch assigns the VFO/MR switch.
- Pressing [0] to [9] allows you to recall a memory channel number 0 to 9.
- You can assign the following key combinations:

Press [F], then press			
[LAMP]	Lamp Latch ON/OFF	[8]	Priority Scan ON/OFF
[BAND]	Menu mode select	[9]	Tone frequency select
[LOW]	Tone ON/OFF	[0]	Memory Channel Lockout ON/OFF
[1]	Squelch level select	[VFO]	Memory → VFO transfer
[4]	Memory name store	[MR]	Memory channel store
[5]	Memory name/frequency change	[CALL]	Call channel store
[6]	CTCSS ON/OFF	[MHz]	Frequency step size select
[7]	Tone Alert ON/OFF	[REV]	Offset direction select

MAINTENANCE

GENERAL INFORMATION

Your transceiver has been factory aligned and tested to specification before shipment. All adjustable trimmers, coils and resistors in the transceiver were preset at the factory. They should only be readjusted by a qualified technician who is familiar with this transceiver and has the necessary test equipment. Attempting service or alignment without factory authorization can void the transceiver warranty.

SERVICE

When returning the equipment to your dealer or service center for repair, pack the transceiver in its original box and packing material. Include a full description of the problems experienced. Include both your telephone number and fax number (if available) along with your name and address in case the service technician needs to call you. Don't return accessory items unless you feel they are directly related to the service problem.

You may return your transceiver for service to the authorized **KENWOOD** dealer from whom you purchased it or any authorized **KENWOOD** service center. A copy of the service report will be returned with the transceiver. Please do not send subassemblies or printed circuit boards. Send the complete transceiver.

13

Tag all returned items with your name and call sign for identification. Please mention the model and serial number of the transceiver in any communication regarding the problem.

SERVICE NOTE

If you desire to correspond on a technical or operational problem, please make your note short, complete, and to the point. Help us help you by providing the following:

- 1 Model and serial number of equipment
- 2 Question or problem you are having
- 3 Other equipment in your station pertaining to the problem
- 4 Meter readings
- 5 Other information (Menu setup, mode, frequency, button sequence to induce malfunction, etc.)

CAUTION: DO NOT PACK THE EQUIPMENT IN CRUSHED NEWSPAPERS FOR SHIPMENT! EXTENSIVE DAMAGE MAY RESULT DURING ROUGH HANDLING OR SHIPPING.

Note:

- ◆ Record the date of purchase, serial number and dealer from whom the transceiver was purchased.
- ◆ For your own information, retain a written record of any maintenance performed on the transceiver.
- ◆ When claiming warranty service, please include a photocopy of the bill of sale, or other proof-of-purchase showing the date of sale.

CLEANING

Remove the controls from the transceiver when they become soiled and clean them with a neutral detergent and warm water. Use a neutral detergent (no strong chemicals) and a damp cloth to clean the case.

CHARGING THE NiCd BATTERY PACK

You must charge the battery pack before using it with the transceiver, or after storing the pack removed from the transceiver for more than 2 months. It takes several charge/ discharge cycles before achieving the full battery pack capacity.

CAUTION:

- ◆ *EXCEEDING THE SPECIFIED CHARGE PERIOD SHORTENS THE USEFUL LIFE OF THE NiCd BATTERY PACK.*
- ◆ *THE PROVIDED CHARGER IS DESIGNED TO CHARGE ONLY THE PROVIDED PB-38 OR PB-39 NiCd BATTERY PACK. CHARGING OTHER MODELS OF BATTERY PACKS WILL DAMAGE THE CHARGER AND BATTERY PACKS.*

Note:

- ◆ *Charging should be done within an ambient temperature between 5°C and 40°C (41°F and 104°F). Charging outside this range may not fully charge the battery.*
- ◆ *Always switch OFF the transceiver equipped with the NiCd battery pack before charging the transceiver. Using the transceiver while charging its battery pack will interfere with correct charging.*
- ◆ *Repeatedly recharging a fully charged battery pack, or almost fully charged pack, shortens its operating time. To resolve this problem, use the pack until it is completely discharged. Then recharge the pack to full capacity.*
- ◆ *If the operating time of a battery pack decreases although the battery pack is fully and correctly charged, the battery pack life is over. Replace the battery pack.*

- 1 Install the NiCd battery pack onto the transceiver {page 2}.
 - Confirm that the transceiver power is OFF.
- 2 Insert the DC plug from the charger into the **DC IN** jack on the transceiver.

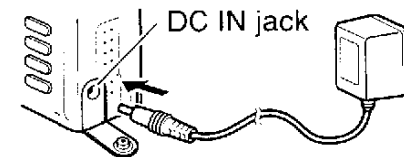

- 3 Insert the charger AC plug into an AC wall outlet.
 - Charging starts and will take approximately 16 hours for PB-38 or 15 hours for PB-39.
- 4 After 16 hours (PB-38) or 15 hours (PB-39), remove the charger DC plug from the transceiver **DC IN** jack.
- 5 Remove the charger AC plug from the AC wall outlet.

TROUBLESHOOTING

The problems described in this table are commonly encountered operational malfunctions. These types of difficulties are usually caused by improper hook-up, accidental incorrect control settings, or operator error due to incomplete programming. These problems are usually not caused by circuit failure. Please review this table, and the appropriate section(s) of this instruction manual, before assuming your transceiver is defective.

Note: Unmodulated carriers may be received due to internal frequency relationships.

Problem	Probable Cause	Corrective Action	Page Ref.
Nothing appears on the display when the transceiver is switched ON, or the display is blinking ON and OFF.	1 Low supply voltage	1 Recharge the battery pack or replace the batteries.	3, 43
	2 If using the optional DC cable: a) Bad power cable or connections b) Open (blown) power supply fuse	2 a) Check the power cable and connections, then correct/replace as necessary. b) Investigate the cause for the open fuse. Replace the fuse.	47 —
Most keys and the Tuning control do not function.	1 Transceiver Lock is ON (Key icon is visible).	1 Press [F] (1 s) to switch OFF Transceiver Lock.	37
	2 The transceiver is in Channel Display mode.	2 Press [BAND]+ POWER ON to exit Channel Display mode.	22
	3 Tone Alert is ON (Bell icon is visible).	3 Press [F] , [7] to switch OFF Tone Alert.	38
Memory channels cannot be recalled.	There is no data stored in any of the memory channels.	Store the desired frequencies in memory channels.	18
You cannot select the exact desired frequency using the Tuning control.	The current frequency step size needs to be changed.	Select the appropriate frequency step size.	40

Problem	Probable Cause	Corrective Action	Page Ref.
You cannot transmit even though you press the PTT switch.	<ol style="list-style-type: none"> 1 You selected a frequency outside the allowable transmit frequency range. 2 You selected a transmit offset that places the transmit frequency outside the allowable transmit frequency range. 3 The TX Inhibit function is ON. 4 The Tone Alert function is ON. 	<ol style="list-style-type: none"> 1 Select a frequency within the allowable transmit frequency range. 2 Press [F], [REV] repeatedly so neither "+" nor "-" is visible. 3 Switch OFF the TX Inhibit function. 4 Switch OFF the Tone Alert function. 	<p style="text-align: center;">9</p> <p style="text-align: center;">13</p> <p style="text-align: center;">37</p> <p style="text-align: center;">38</p>
The transceiver switches OFF for no apparent reason.	The Automatic Power Off (APO) function is ON.	Switch OFF the APO function.	37
Packet operation results in no connects with other stations.	<ol style="list-style-type: none"> 1 Physical connections between the transceiver, computer, and TNC are incorrect, or software settings in the TNC are wrong. 2 Different transmit and receive frequencies are being used. Usually, you must use the same transmit and receive frequency for packet. 3 The modulation level from the TNC is incorrect. 4 There is multi-path distortion. 5 The squelch is open. 	<ol style="list-style-type: none"> 1 Recheck all connections using this manual, your TNC manual and your computer hardware manual as reference. 2 If using VFO mode, switch OFF the transmit offset. If using Memory Recall, select a simplex memory channel. 3 Adjust the TNC modulation level according to the TNC manual. 4 Reorient the antenna. The strongest signal does not always provide the best operation on packet. 5 Close the squelch. 	<p style="text-align: center;">48</p> <p style="text-align: center;">13, 17</p> <p style="text-align: center;">—</p> <p style="text-align: center;">—</p> <p style="text-align: center;">8</p>

OPTIONAL ACCESSORIES

SMC-32
Speaker
Microphone

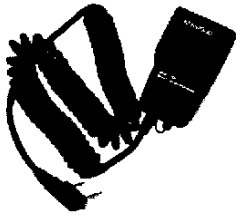

SMC-33
Remote Control
Speaker Microphone



SMC-34
Remote Control Speaker
Microphone (with Volume Control)



HMC-3
Head Set with
VOX/PTT



EMC-3
Clip Microphone
with Earphone



HS-9
Earphone



PB-38
Standard Battery Pack
(6 V/ 650 mAh)



PB-39
High-power Battery Pack
(9.6 V/ 600 mAh)



BT-11
Battery Case



BC-17
Wall Charger



BC-19
Rapid Charger



PG-2W
DC Cable



PG-3J
Filtered Cigarette
Lighter Cable



SC-45
Soft Case

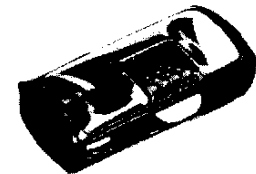

EQUIPMENT INSTALLATION AND CONNECTION

CONNECTING AN EXTERNAL POWER SOURCE

You can connect the transceiver to a regulated power supply via an optional PG-2W cable, or to the cigarette lighter socket in your vehicle via an optional PG-3J cable.

Note: If input voltage exceeds approximately 18 V, warning beeps sound and "DC ERR" appears on the display.

■ Using a Regulated Power Supply

Note:

- ◆ Switch OFF the transceiver and power supply before making any connections.
- ◆ Only use the power supplies recommended by your authorized **KENWOOD** dealer. The supply voltage must be between 6 V and 16 V to prevent damaging the transceiver.

- 1 Connect the red lead of the optional PG-2W DC cable to the positive (+) terminal on the power supply. Connect the black lead of this cable to the negative (-) terminal.
- 2 Connect the barrel plug on the DC cable to the **DC IN** jack on the side of the transceiver.

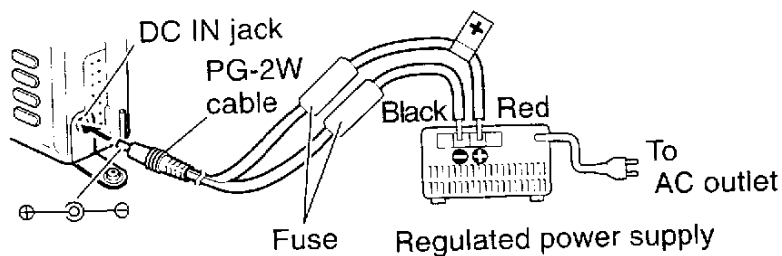

■ Using a Cigarette Lighter Socket

Connect the transceiver to the cigarette lighter socket in your vehicle using the optional PG-3J Cigarette Lighter cable.

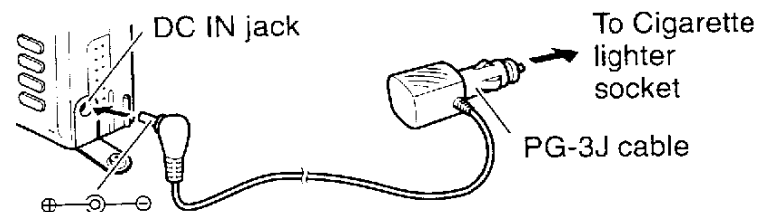

CAUTION: TO CONNECT AN EXTERNAL 24 V POWER SOURCE VIA A DC-DC CONVERTER, ONLY USE THE PG-3J CIGARETTE LIGHTER CABLE. USING THE PG-2W DC CABLE IN THIS SITUATION MAY CAUSE A FIRE.

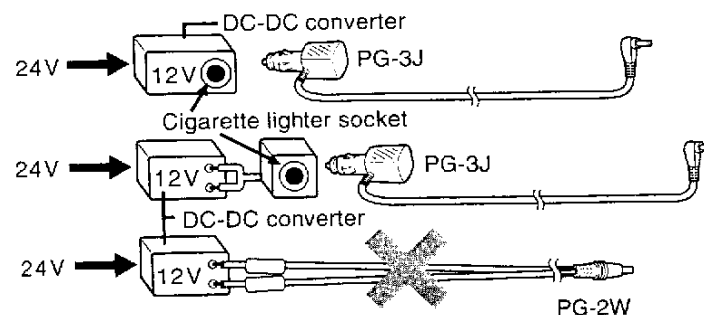

CONNECTING EQUIPMENT FOR REMOTE CONTROL

Make connections as shown when remotely controlling equipment.

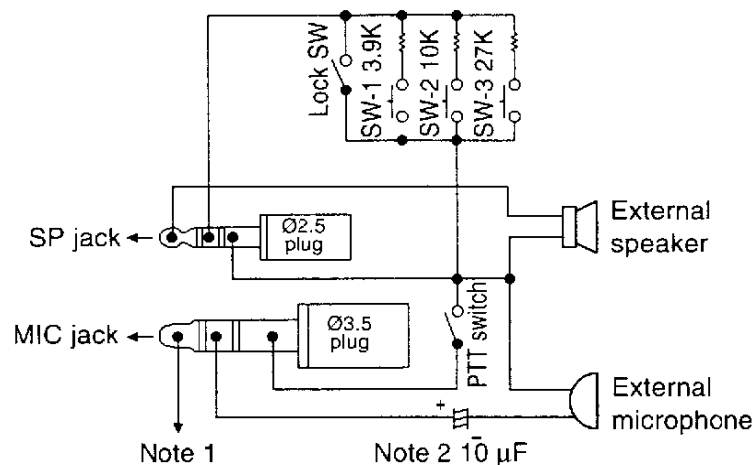

Note 1: Voltage is developed across the $100\ \Omega$ resistor in the 3.5 V line in the transceiver. When 2 mA flows, approximately 3.3 V is developed.

Note 2: A $10\ \mu\text{F}$ capacitor is not required in the following cases:

- When the other equipment has DC blocking capacitors.
- When a 2-terminal electret condenser microphone is used.

CONNECTING OTHER EXTERNAL EQUIPMENT

When connecting an external speaker, an external microphone, or other equipment such as a TNC for packet radio to the SP jack or MIC jack, refer to the diagram below.

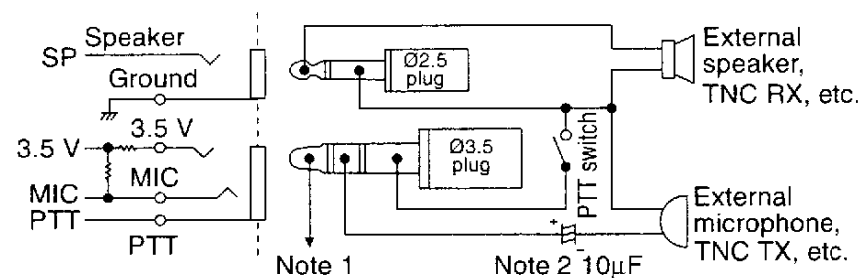

Note 1: Voltage is developed across the $100\ \Omega$ resistor in the 3.5 V line in the transceiver. When 2 mA flows, approximately 3.3 V is developed.

Note 2: A $10\ \mu\text{F}$ capacitor is not required in the following cases:

- When the other equipment has DC blocking capacitors.
- When a 2-terminal electret condenser microphone is used.

SPECIFICATIONS

Specifications are subject to change without notice due to advancements in technology.

General		VHF Band	UHF Band
Frequency range	U.S.A./ Canada	144 to 148 MHz	438 to 450 MHz
	General Market	144 to 148 MHz	430 to 440 MHz
	Europe	144 to 146 MHz	430 to 440 MHz
Mode		F3E (FM)	
Usable temperature range		-20°C to +60°C (-4°F to +140°F)	
Rated voltage	External power supply (DC IN)	5.5 to 16.0 V (13.8 V)	
	Battery terminals	4.5 to 15.0 V (6.0 V)	
Current	Receive with no signals	Approx. 70 mA	
	Battery Saver ON	Average 30 mA	
	Transmit with HI, 13.8 V (DC IN)	Approx. 1.7 A	Approx. 2.1 A
	Transmit with HI, 9.6 V (battery terminals)	Approx. 1.7 A	Approx. 1.8 A
	Transmit with HI, 6.0 V (battery terminals)	Approx. 1.3 A	Approx. 1.5 A
	Transmit with LO, 6.0 V (battery terminals)	Approx. 500 mA	
Transmit with EL, 6.0 V (battery terminals)	Approx. 300 mA		
Ground method		Negative	
Dimensions (W x H x D, projections not included) ¹		54 x 112 x 33.5 mm/ 2.13 x 4.41 x 1.32 in	
Weight ^{1,2}		Approx. 330 g/ 11.6 oz	
Microphone impedance		2 kΩ	
Antenna impedance		50 Ω	

¹ With a PB-38 installed

² PB-38, antenna, and belt hook included

Transmitter		VHF Band	UHF Band
Power output	HI, 13.8 V	6 W	5.5 W
	HI, 9.6 V	Approx. 5 W	
	HI, 6.0 V	Approx. 2.5 W	Approx. 2.2 W
	LO, 6.0 V	Approx. 0.5 W	
	EL, 6.0 V	Approx. 50 mW	
Modulation		Reactance	
Maximum frequency deviation		Within ± 5 kHz	
Spurious emissions		-60 dB or less	

Receiver		VHF Band	UHF Band
Circuitry		Double conversion superheterodyne	
1st intermediate frequency		38.85 MHz	
2nd intermediate frequency		450 kHz	
Sensitivity (12 dB SINAD)		0.18 μ V or less	
Squelch sensitivity		0.1 μ V or less	
Selectivity (-6 dB)		12 kHz or more	
Selectivity (-40 dB)		28 kHz or less	
Audio output (10% distortion)	9.6 V (battery terminals)	500 mW or higher (8 Ω load)	
	6.0 V (battery terminals)	300 mW or higher (8 Ω load)	

QUICK REFERENCE GUIDE

Note:

- ◆ This guide covers only the functions that require a small number of operation steps.
- ◆ Some functions ask you to press any key other than a couple of keys to complete the setting or to stop operation. In such a case, one recommended key is given in the table.

Function	Key Operation	Ref. Page
Automatic Power Off (APO) ON/OFF	[F], [BAND] → Tuning control (Menu No. 5) → [BAND] → [F]	37
Battery Saver ON/OFF	[F], [BAND] → Tuning control (Menu No. 4) → [BAND] → [F]	37
Beep ON/OFF	[F], [BAND] → Tuning control (Menu No. 6) → [BAND] → [F]	38
Channel Display ON/OFF	POWER OFF → [BAND]+ POWER ON	22
CTCSS		
ON/OFF	Select band → [F], [6]	32
Automatic Tone Frequency ID ON	Select band → [F], [6] (1 s)	33
Frequency Select	Switch CTCSS ON → [F], [9] → Tuning control → [F]	32
Frequency Step Size Select	Select band → [F], [MHz] → Tuning control → [F]	40
Lamp Latch ON/OFF	[F], [LAMP]	38
Repeater		
Automatic Offset (U.S.A./ Canada/ Europe only)	[F], [BAND] → Tuning control (Menu No. 7) → [BAND] → [F]	15
Offset Direction Select	Select band → [F], [REV]	13
Offset Frequency Select	Select band → [F], [BAND] → Tuning control (Menu No. 8) → [BAND] → Tuning control → [BAND] → [F]	13
Tone ON/OFF	Select band → [F], [LOW]	14
Tone Frequency Select	Switch Tone ON → [F], [9] → Tuning control → [F]	14

Continued

[REV]		
Reset		
Full (memory)	POWER OFF → [F]+ POWER ON → [F]	23
Partial (VFO)	POWER OFF → [VFO]+ POWER ON → [VFO]	23
Reverse ON/OFF	Select band → [REV]	16
Scan Start		
Call/Memory	Select band → [MR] → [CALL] (1 s)	29
Call/VFO	[VFO] → Select band → [CALL] (1 s)	29
Memory	[MR] (1 s)	26
MHz	[VFO] → Select band → [MHz] (1 s)	27
VFO	Select band → [VFO] (1 s)	26
Scan Stop	[CALL], [VFO], [MR], or [MHz] (last key you pressed to start Scan)	26, 27, 29
Scan Resume Method	[F], [BAND] → Tuning control (Menu No. 1) → [BAND] → [F]	25
Speaker Configuration Change	[F], [BAND] → Tuning control (Menu No. 14) → [BAND] → [F]	39
Squelch Level Adjust	[F], [1] → Tuning control → [F]	8
Tone Alert	Select band → [F], [7]	38
Transceiver Lock		
ON/OFF	[F] (1 s)	37
Tuning Control Enable	[F], [BAND] → Tuning control (Menu No. 9) → [BAND] → [F]	37
Transmit Power Select	Select band → [LOW]	9
TX Inhibit ON/OFF	[F], [BAND] → Tuning control (Menu No. 12) → [BAND] → [F]	37

INDEX

Accessories			
Optional	46		
Supplied	1		
Automatic Power Off (APO)	37		
Automatic Tone Frequency ID	33		
Autopatch (U.S.A. and Canada)	34		
Battery			
Charging	43		
Installing, Alkaline	3		
Installing, NiCd	2		
Battery Saver	37		
Band, Selecting	9		
Beep ON/OFF	38		
Call Channel			
Contents, Changing	21		
Recalling	21		
Channel Display Function	22		
Connection			
Cigarette Lighter	47		
Regulated Power Supply	47		
Continuous Tone Coded			
Squelch System (CTCSS)			
Automatic Tone Frequency ID	33		
Using	32		
Dual Tone Multi-Frequency			
(DTMF) Functions			
Confirming Stored Numbers	35		
Making Calls	34		
Storing Numbers	35		
Tone TX Hold	34		
Transmitting Stored Numbers	36		
Frequency, Selecting	9, 40		
Frequency Step Size	40		
Installation			
Antenna	4		
Belt hook	4		
Hand strap	4		
Keypad Direct Entry			
Frequency	40		
Memory Channel Number	40		
Lamp Function	38		
Lock, Transceiver	37		
Maintenance	42		
Memory Channels			
Clearing	19		
Direct Number Entry	40		
Initializing	23		
Locking Out	27		
Naming	20		
Recalling	19		
Storing, Simplex	18		
Storing, Split	18		
Transfer to VFO	22		
Menu	10		
Microphone Control	41		
Offset			
Automatic Repeater	15		
Offset Direction	13		
Offset Frequency	13		
Power, ON/OFF	8		
Programmable VFO	39		
Repeater Access	12		
Reset			
Full (Memory)	23		
Partial (VFO)	23		
Reverse Function	16		
Scan			
Call/Memory	29		
Call/VFO	29		
Memory	26		
MHz	27		
Priority	30		
Program	28		
VFO	26		
Scan Resume			
Carrier-Operated	25		
Seek	25		
Time-Operated	25		
Specifications	49		
Squelch, Adjusting	8		
Time-Out Timer (TOT)	9		
Tone			
Activating	14		
Frequency, Selecting	14		
Tone Alert	38		
Transmit Power, Selecting	9		
Troubleshooting	44		
TX Inhibit	37		
Volume, Adjusting	8		

KENWOOD