

KENWOOD

144 MHz FM TRANSCEIVER

TH-235A

144 MHz FM TRANSCEIVER

TH-235E

INSTRUCTION MANUAL

KENWOOD CORPORATION

© B62-0750-00 (K,E,T,M,A)
09 08 07 06 05 04 03 02 01 00

THANK YOU!

We are grateful you decided to purchase this **KENWOOD** FM transceiver. This series of handhelds were developed to satisfy the requirement for a compact rig that's simple to operate yet contains numerous sophisticated features. **KENWOOD** believes that the compact size coupled with the reasonable cost will guarantee your satisfaction with this product.

MODELS COVERED BY THIS MANUAL

The models listed below are covered by this manual.

TH-235A: 144 MHz FM transceiver
(U.S.A./ Canada/ General market)

TH-235E: 144 MHz FM transceiver
(Europe)

FEATURES

- Contains 60 memory channels programmable with desired frequencies and related data (Tone, CTCSS, DTSS, etc.)
- Equipped with a keypad that includes numeric keys, so frequencies or memory channels are selectable via keypad direct entry.
- Innovative Menu Set-up method combines sophisticated features with simple operation; only frequently-used keys are placed on the front and side panels.
- Dual Tone Squelch System (DTSS) allows selective calling of specific stations.
- Programmable with a RX tone and TX tone separately. This enhances the optional Continuous Tone Coded Squelch System (CTCSS).

NOTICES TO THE USER



ATTENTION (U.S.A. Only)

Nickel-Cadmium batteries must be replaced or disposed of properly.

State laws may vary regarding the handling and disposal of Nickel-Cadmium batteries.

*Please contact your authorized **KENWOOD** dealer for more information.*

One or more of the following statements may be applicable:

FCC WARNING

This equipment generates or uses radio frequency energy. Changes or modifications to this equipment may cause harmful interference unless the modifications are expressly approved in the instruction manual. The user could lose the authority to operate this equipment if an unauthorized change or modification is made.

INFORMATION TO THE DIGITAL DEVICE USER REQUIRED BY THE FCC

This equipment has been tested and found to comply with the limits for a Class B digital device, pursuant to Part 15 of the FCC Rules. These limits are designed to provide reasonable protection against harmful interference in a residential installation.

This equipment generates, uses and can generate radio frequency energy and, if not installed and used in accordance with the instructions, may cause harmful interference to radio communications. However, there is no guarantee that the interference will not occur in a particular installation. If this equipment does cause harmful interference to radio or television reception, which can be determined by turning the equipment off and on, the user is encouraged to try to correct the interference by one or more of the following measures:

- *Reorient or relocate the receiving antenna.*
- *Increase the separation between the equipment and receiver.*
- *Connect the equipment to an outlet on a circuit different from that to which the receiver is connected.*
- *Consult the dealer for technical assistance.*

PRECAUTIONS

Please observe the following precautions to prevent fire, personal injury, and transceiver damage:

- Do not transmit with high output power for extended periods. The transceiver may overheat.
- Do not modify this transceiver unless instructed by this manual or by **KENWOOD** documentation.
- When using a regulated power supply, connect the specified DC cable (option) to the DC IN jack on the transceiver. The supply voltage must be between 7.5 V and 16 V to prevent damaging the transceiver.
- When connecting the transceiver to a cigarette lighter socket in a vehicle, use the specified cigarette lighter cable (option).
- Do not expose the transceiver to long periods of direct sunlight nor place the transceiver close to heating appliances.
- Do not place the transceiver in excessively dusty areas, humid areas, wet areas, nor on unstable surfaces.
- If an abnormal odor or smoke is detected coming from the transceiver, turn OFF the power immediately and remove the battery case or the battery pack from the transceiver. Contact a **KENWOOD** service station or your dealer.

CONTENTS

SUPPLIED ACCESSORIES	1		
CONVENTIONS FOLLOWED IN THIS MANUAL	1		
CHAPTER ① BATTERY INFORMATION		CHAPTER ⑥ OPERATING THROUGH REPEATERS	
INSTALLING/REMOVING THE NiCd BATTERY PACK	2	REPEATER ACCESS	11
INSTALLING/REMOVING ALKALINE BATTERIES	3	Selecting Offset Direction	12
BATTERY OPERATING TIME	4	Selecting Offset Frequency	12
CHAPTER ② YOUR FIRST CONTACT (QSO)		Activating Tone Function	13
CHAPTER ③ GETTING ACQUAINTED		Selecting a Tone Frequency	13
ORIENTATION	6	Automatic Repeater Offset (U.S.A./ Canada/ Europe Only)	14
BASIC TRANSCEIVER MODES	6	REVERSE FUNCTION	15
DISPLAY	7	CHAPTER ⑦ MEMORY CHANNELS	
CHAPTER ④ OPERATING BASICS		SIMPLEX OR SPLIT MEMORY CHANNEL?	16
SWITCHING POWER ON/OFF	8	STORING DATA IN SIMPLEX CHANNELS	17
ADJUSTING VOLUME	8	STORING DATA IN SPLIT CHANNELS	17
ADJUSTING SQUELCH	8	CONTINUOUSLY STORING IN SIMPLEX OR SPLIT CHANNELS	18
SELECTING FREQUENCIES	9	RECALLING MEMORY CHANNELS	19
TRANSMITTING	9	CLEARING MEMORY CHANNELS	19
Selecting Transmit Power	9	MEMORY → VFO TRANSFERS	19
CHAPTER ⑤ MENU SET-UP		● CLONE	20
MENU ACCESS	10	● CHANNEL DISPLAY FUNCTION	21
MENU CONFIGURATION	10	INITIALIZING MEMORY	21
		Partial Reset (VFO)	21
		Full Reset (Memory)	21

CHAPTER 8 SCAN

SCAN RESUME METHODS 22
 Selecting Scan Resume Method 23
VFO SCAN 23
MEMORY SCAN 24
 Locking Out Memory Channels 24

CHAPTER 9 CONTINUOUS TONE CODED SQUELCH SYSTEM (CTCSS)

USING CTCSS 25

CHAPTER 10 DUAL TONE SQUELCH SYSTEM (DTSS)

STORING DTSS CODES 27
USING DTSS 27
 DTSS and Repeaters 28

CHAPTER 11 DUAL TONE MULTI-FREQUENCY (DTMF) FUNCTIONS

MAKING DTMF CALLS 29
 DTMF Tone TX Hold 29
 Autopatch (U.S.A. and Canada) 29
STORING DTMF NUMBERS FOR
AUTOMATIC DIALER 30
CONFIRMING STORED DTMF NUMBERS 30
TRANSMITTING STORED DTMF NUMBERS 31
TRANSMITTING SINGLE-FREQUENCY TONES ... 31

CHAPTER 12 AUXILIARY FUNCTIONS

TIME-OUT TIMER (TOT) 32
TX INHIBIT 32
BUSY CHANNEL LOCKOUT 32
TRANSCEIVER LOCK 32
AUTOMATIC POWER OFF (APO) 33
BATTERY SAVER 33
LAMP FUNCTION 33
BEEP ON/OFF 33
KEYPAD DIRECT ENTRY 34
 Frequency Entry 34
 Memory Channel Number Entry 34
CHANGING FREQUENCY STEP SIZE 35

CHAPTER 13 MICROPHONE CONTROL

CHAPTER 14 MAINTENANCE

GENERAL INFORMATION 37
SERVICE 37
SERVICE NOTE 37
CLEANING 37
CHARGING THE NiCd BATTERY PACK 38
 Using the Wall Charger 38
 Using the Slot-type Charger 39



TRUBLESHOOTING	40
CHAPTER 15	OPTIONAL ACCESSORIES
CHAPTER 16	EQUIPMENT INSTALLATION AND CONNECTION
INSTALLING THE TSU-8 UNIT	43
CONNECTING AN EXTERNAL POWER SOURCE .	45
Using a Regulated Power Supply	45
Using a Cigarette Lighter Socket	45
CONNECTING EQUIPMENT FOR REMOTE CONTROL	46
CONNECTING OTHER EXTERNAL EQUIPMENT .	46
INSTALLING/REMOVING THE BELT HOOK	46
SPECIFICATIONS	
INDEX	

SUPPLIED ACCESSORIES

Accessory	Part Number	Quantity
Antenna	T90-0472-XX	1
NiCd battery pack PB-36 (7.2 V, 950 mAh) ¹	W09-0890-XX	1
PB-37 (12 V, 950 mAh) ²	W09-0889-XX	1
Battery case (BT-10) ²	A02-2042-XX	1
Battery charger U.S.A./ Canada	W08-0437-XX	1
Europe (United Kingdom)	W08-0438-XX	1
Europe (some)	W08-0440-XX	1
Europe (some)	W08-0504-XX	1
General (some)	W08-0505-XX	1
General (some)	W22-0108-XX	1
General (some)	W22-0109-XX	1
AC plug adapter ²	E19-0254-XX	1
Belt hook ³	J29-0631-XX	1
Warranty card U.S.A./ Canada/ Europe only	—	1
Instruction manual	B62-0750-XX	1

¹ Excluding some General market versions

² Some General market versions only

³ For the method of installing and removing the belt hook, refer to "INSTALLING/REMOVING THE BELT HOOK" (page 46).

CONVENTIONS FOLLOWED IN THIS MANUAL

The writing conventions described below have been followed to simplify instructions and avoid unnecessary repetition.

ATTENTION: MOST PROCEDURES REQUIRE THAT YOU PRESS AN APPROPRIATE KEY IN EACH STEP WITHIN APPROXIMATELY 10 SECONDS, OR THE PREVIOUS MODE WILL BE RESTORED.

Instruction	What to do
Press [KEY] .	Press and release KEY .
Press [KEY] (1 s).	Press and hold KEY until the function begins.
Press [KEY1] , [KEY2] .	Press KEY1 momentarily, release KEY1 , then press KEY2 .
Press [KEY1]+[KEY2] .	Press and hold KEY1 , then press KEY2 .
Press [KEY]+ POWER ON .	With transceiver power OFF, press and hold KEY , then press the POWER switch.
Press [KEY1]+[KEY2]+ POWER ON .	With transceiver power OFF, press and hold KEY1 and KEY2 , then press the POWER switch.

BATTERY INFORMATION

1 INSTALLING/REMOVING THE NiCd BATTERY PACK

Note: Because the battery pack is provided uncharged, charge the battery pack before using it with the transceiver. For the method of charging the battery pack, refer to "CHARGING THE NiCd BATTERY PACK" (page 38).

- 1 Align the grooves in the battery pack with the transceiver.

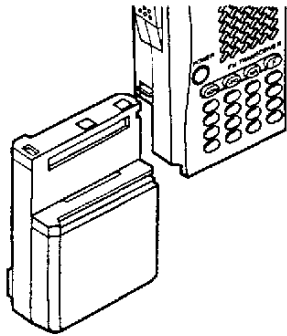

- 2 Slide the battery pack until it locks in place.

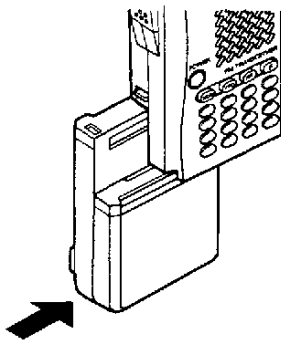

- 3 To remove the battery pack, hold the transceiver as shown, push up on the release switch, then slide the battery pack back.

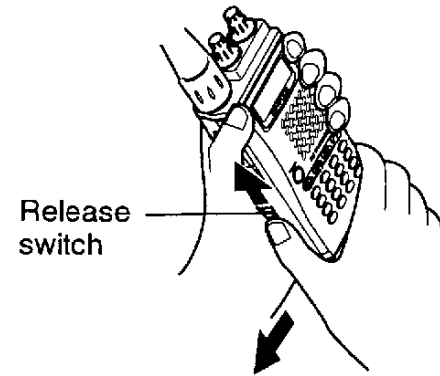

INSTALLING/REMOVING ALKALINE BATTERIES

WARNING!

- ◆ DO NOT INSTALL THE BATTERIES IN A HAZARDOUS ENVIRONMENT WHERE SPARKS COULD CAUSE AN EXPLOSION.
- ◆ NEVER DISCARD OLD BATTERIES IN FIRE BECAUSE EXTREMELY HIGH TEMPERATURES CAN CAUSE BATTERIES TO EXPLODE.

Note:

- ◆ It is recommended to use high quality alkaline batteries rather than manganese batteries to enjoy longer periods of battery life. Do not use commercially available NiCd batteries.
- ◆ If you will not use the transceiver for a long period, remove the batteries from the battery case.

- 1 To open the battery case, push on the locking tab and pull the two case halves apart.

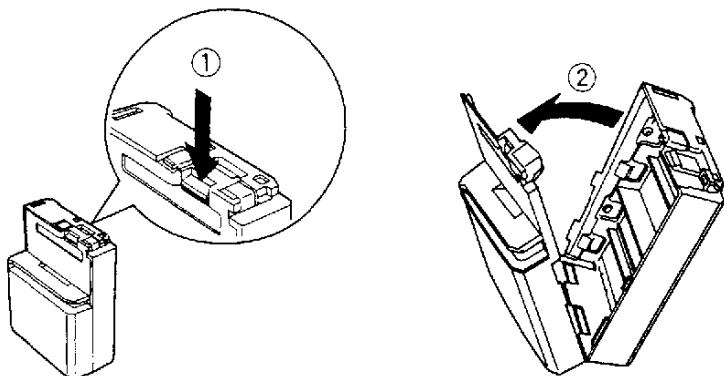

- 2 Insert six AA (LR 6) alkaline batteries in the battery case; two in the upper half and four in the lower half.
 - Be careful with the battery polarities marked on the bottom of each case half.

1

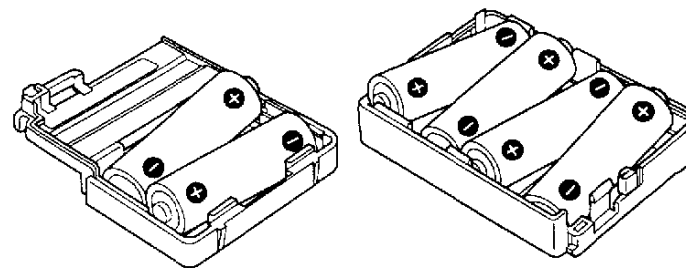

- 3 Align the two tabs on the upper half with the matching grooves on the lower half, and press the two halves together until the locking tab clicks.

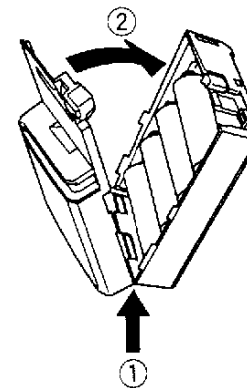

- 4 Align the grooves in the battery case with the transceiver.

1

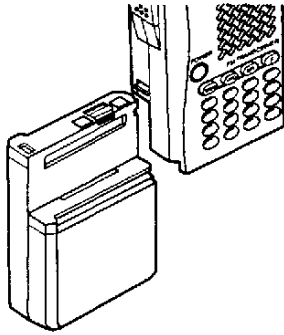

- 5 Slide the battery case until it locks in place. To remove the battery pack, hold the transceiver as shown, push up on the release switch, then slide the battery case back.

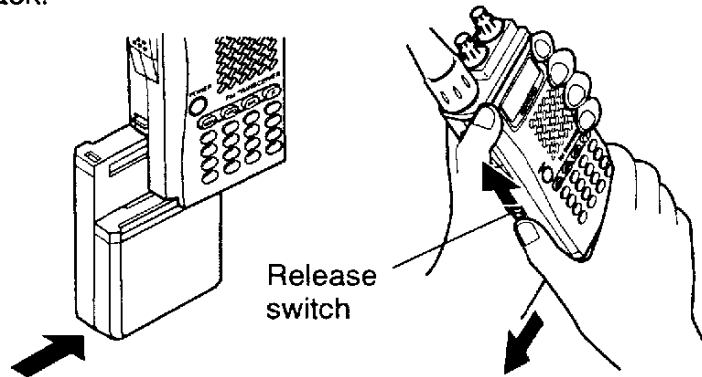

BATTERY OPERATING TIME

The following table shows the approximate battery life (hours) relative to the transmit output power.

Batteries	High Power	Low Power
PB-36 NiCd	9 hr.	11 hr.
PB-37 NiCd	8 hr.	11 hr.
Alkaline	15 hr.	16 hr.

Note: The times shown in the table were measured with the following repeated cycle: 6 second TX, 6 second RX, and 48 second standby.

YOUR FIRST CONTACT (QSO)

If you tend to discard instruction manuals along with the packaging materialplease don't. The 6 steps given here will get you on the air right away. So, you can enjoy the exhilaration that comes with opening a brand new transceiver.

❶ Holding the antenna at its base, push it onto the BNC connector and twist until it locks in place.

❷ Press the **POWER** switch.

❸ Turn the **VOL** control to approximately 11 o'clock.

❹ Turn the **Tuning** control to select a frequency.

❺ Press and hold the **PTT** switch, then speak in a normal tone of voice.

❻ When you finish speaking, release the **PTT** switch to receive.

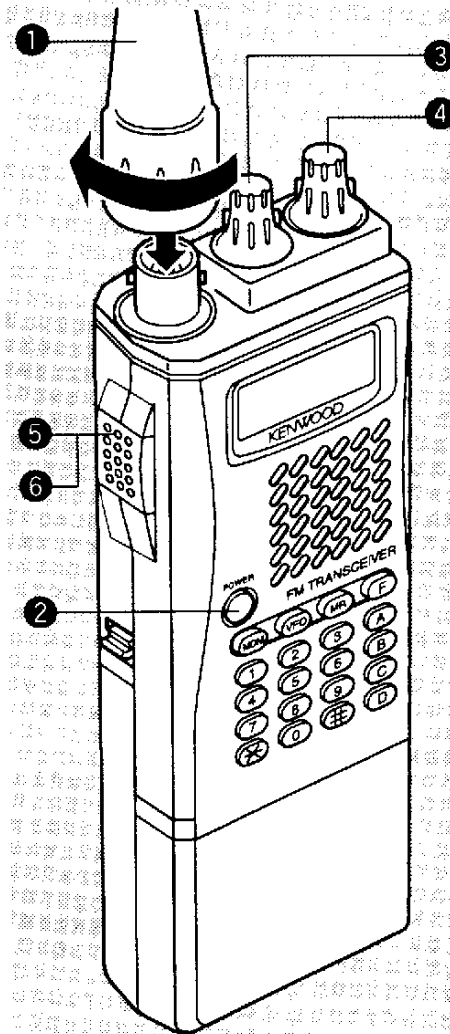

CAUTION:

- ◆ THE RECOMMENDED DUTY CYCLE IS 1 MINUTE OF TRANSMISSION AND 3 MINUTES OF RECEPTION. LONGER TRANSMISSIONS OR EXTENDED OPERATION IN THE HIGH POWER MODE MAY CAUSE THE BACK OF THE TRANSCEIVER TO GET HOT. DO NOT PLACE THE TRANSCEIVER WHERE THE HEAT SINK (REAR PANEL) MIGHT COME IN CONTACT WITH PLASTIC OR VINYL SURFACES.
- ◆ TRANSMITTING WITH THE SUPPLIED ANTENNA NEAR OTHER ELECTRONIC EQUIPMENT CAN INTERFERE WITH THAT EQUIPMENT. ALSO, TRANSMITTING NEAR A REGULATED POWER SUPPLY, THAT IS NOT RECOMMENDED BY **KENWOOD**, MAY CAUSE THE POWER SUPPLY TO OUTPUT AN EXTREMELY HIGH VOLTAGE. THIS VOLTAGE COULD DAMAGE BOTH YOUR TRANSCEIVER AND ANY OTHER EQUIPMENT CONNECTED TO THE POWER SUPPLY.

Note: The installed antenna can continuously turn around the connector.

2

GETTING ACQUAINTED

ORIENTATION

3

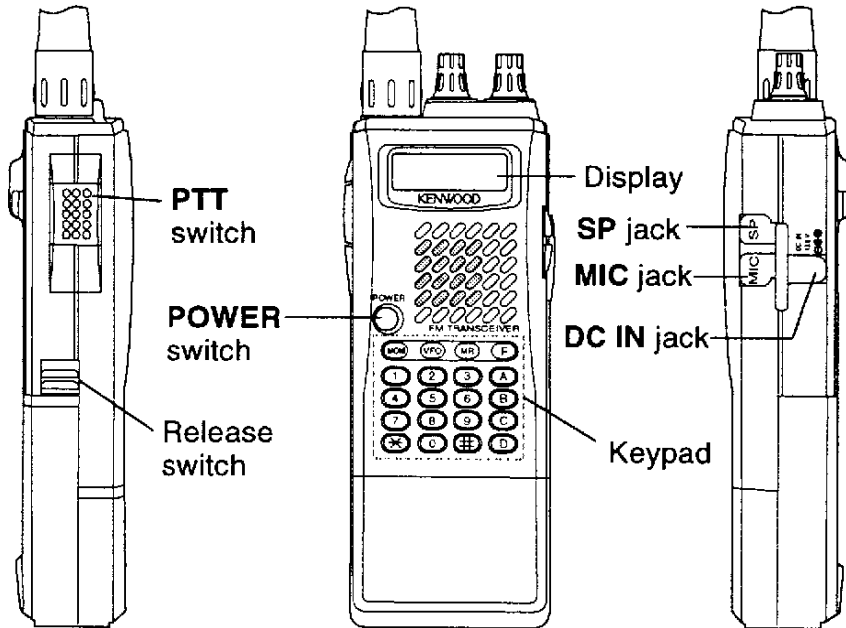
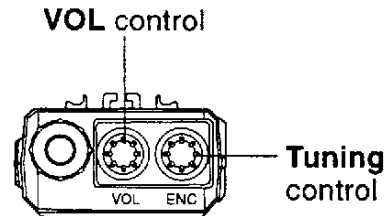

BASIC TRANSCEIVER MODES

This section introduces you to the two basic modes that you will select most frequently.

VFO mode

Press [VFO] to select. In this mode you can change the operating frequency using the **Tuning** control.

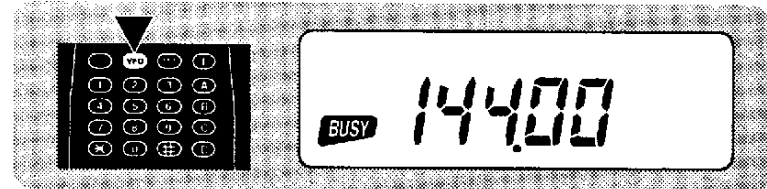

Memory Recall mode

Press [MR] to select. In this mode you can change memory channels, using the **Tuning** control, where you stored frequencies and related data. For further information, refer to "MEMORY CHANNELS" {page 16}.

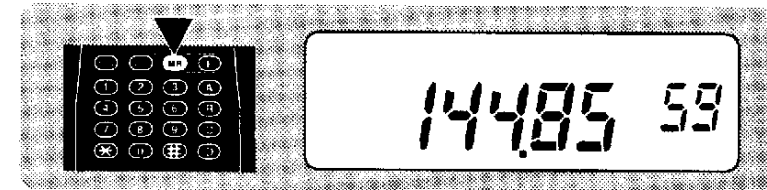

DISPLAY

On the display you will see various indicators that show what you have selected. Sometimes you may not recall what those indicators mean or how you can cancel the current setting. In such a case, you will find the following table very useful.

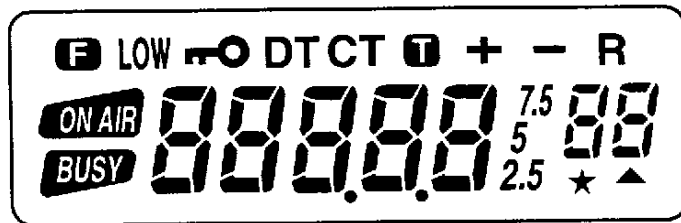

88888

Displays the operating frequency, frequency step size, or tone frequency.

88

Displays the current memory channel when in Memory Recall mode.

Indicator	What You Selected	What You Press to Cancel	Ref. Page
[F]	Second Function Select mode	[F]	—
LOW	Low transmit power	[C]	9
Key icon	Transceiver Lock	[F], [B]	32
DT	DTSS	[F], [1]	27
CT ¹	CTCSS	[F], [3]	25
[T]	Tone function	[A]	13
+	Plus offset direction	[F], [#], [F], [#]	12
-	Minus offset direction	[F], [#]	12
R	Reverse function	[#]	15
★	Memory Channel Lockout	[F], [9]	24
▲ ²	Memory channel containing data	—	17, 18
ON AIR	Transmit mode	Release the PTT switch	9
BUSY	Visible while squelch is open.	—	8

¹ Appears only when you have installed the optional TSU-8 unit.

² Blinking "▲" indicates that the channel contains no data.

OPERATING BASICS

SWITCHING POWER ON/OFF

Press the **POWER** switch to turn the transceiver ON or OFF.

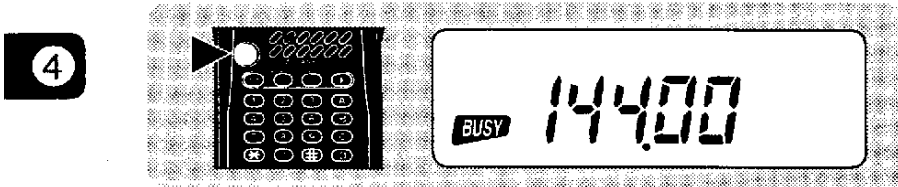

ADJUSTING VOLUME

Press and hold **[MONI]**, then turn the **VOL** control clockwise to increase the audio level or counterclockwise to decrease the audio level.

- If "BUSY" is visible, you need not press and hold **[MONI]**.

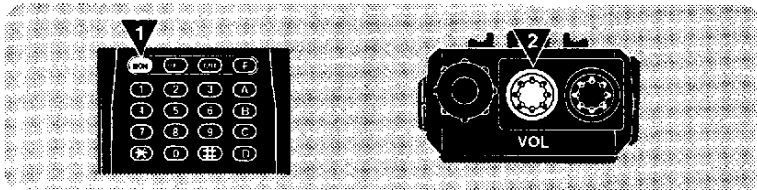

Note: To hear a weak signal or background noise, deactivate the Squelch function by pressing **[MONI]**.

ADJUSTING SQUELCH

The purpose of the Squelch function is to silence background noise output from the speaker (squelch closed) when no signals are present. When the squelch level is set correctly, you will hear sound (squelch opened) only while a station is actually being received.

- 1 Press **[F]**, **[MONI]**.

- The current squelch level appears. The default is level 1.

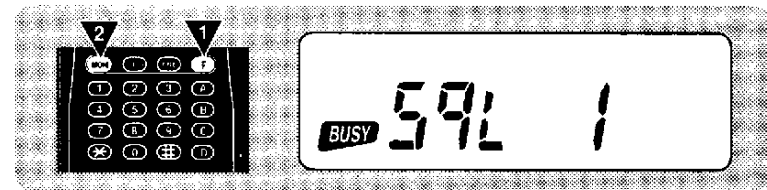

- 2 Turn the **Tuning** control to select level 0, 1, or 2.

- Selecting level 0 allows you to hear weak signals, however, background noise is always audible.
- Selecting level 2 allows you to hear only strong signals.

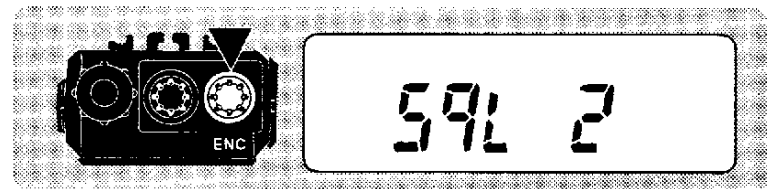

- 3 Press any key other than **[MONI]** and **[D]** to complete setting.

SELECTING FREQUENCIES

- 1 Press [VFO] to select VFO mode.

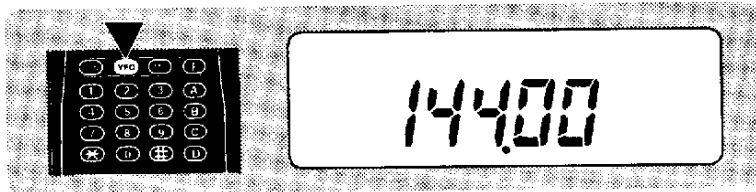

- 2 Turn the **Tuning** control clockwise to increase the frequency or counterclockwise to decrease the frequency.

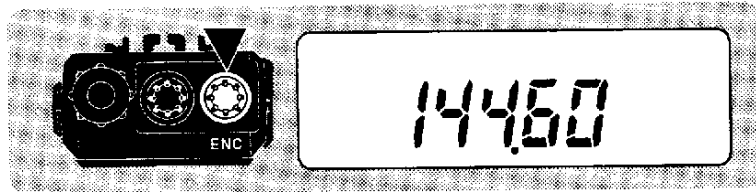

- To change frequencies in steps of 1 MHz, press [B] first. The 1 MHz digit blinks. Pressing [B] again cancels this function.
- If you cannot select a particular frequency, the frequency step size needs to be changed. See “CHANGING FREQUENCY STEP SIZE” {page 35}.
- You can also select frequencies with the numeric keys. See “KEYPAD DIRECT ENTRY” {page 34}.

TRANSMITTING

- 1 When ready to begin transmitting, press and hold the **PTT** switch, and speak in a normal tone of voice.
 - “ON AIR” appears.

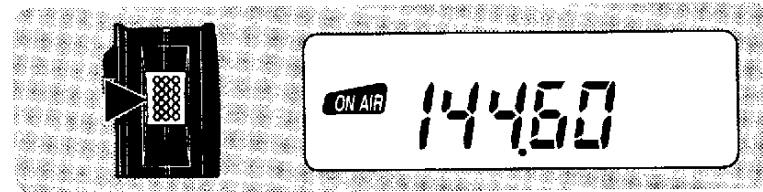

4

- Speaking too close to the microphone, or too loudly, may increase distortion and reduce intelligibility of your signal at the receiving station.
- 2 When you finish speaking, release the **PTT** switch.

■ Selecting Transmit Power

Press [C] to toggle high (default) or low power.

- “LOW” appears when low power is selected.

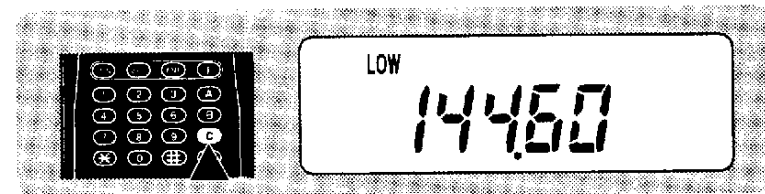

Note: Selecting low transmit power is a wise method to reduce battery consumption if communication is still reliable.

MENU SET-UP

Many functions on this transceiver are selected or configured via a software-controlled Menu instead of physical controls on the transceiver.

MENU ACCESS

- Press [*****] to enter Menu mode.
 - The last Menu No. used appears.

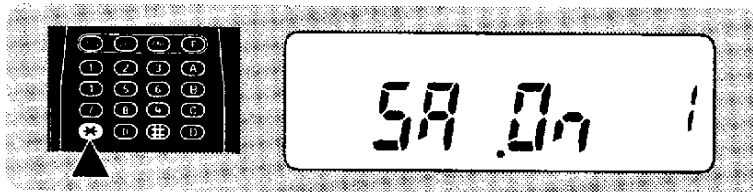

- Turn the **Tuning** control to select the desired Menu No.

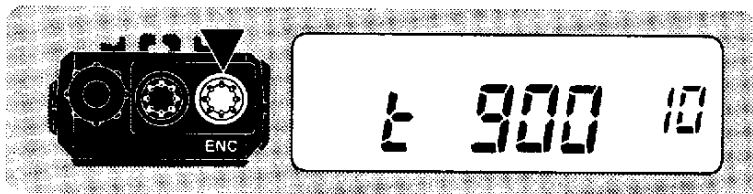

- Press [**F**] to toggle the selection.
- Press any key other than [**MONI**], [**F**], and [**D**] to exit Menu mode.

Note: As required, turn the **Tuning** control or press [**F**] within approximately 10 seconds, or the previous mode will be restored.

MENU CONFIGURATION

Menu No.	Description	Selections	Default	Ref. Page
1	Battery Saver	ON/OFF	ON	33
2	Automatic Power OFF	ON/OFF	OFF	33
3	Scan Resume Method	Time-Operated/ Carrier-Operated	Time-Operated	22
4	Beep ON/OFF	ON/OFF	ON	33
5	TX Inhibit	ON/OFF	OFF	32
6	Tuning Control Enable	ON/OFF	OFF	32
7	DTSS Code TX Delay	350 ms/ 550 ms	350 ms	28
8	DTMF Tone TX Hold	ON/OFF	OFF	29
9	Busy Channel Lockout	ON/OFF	OFF	32
10	Time-Out Timer	900/ 180/ 90/ 60/ 30 sec.	900 sec.	32
11	DTSS Group Code	A/ B/ C/ D/ E/ F/ OFF	OFF	27
12	Automatic Repeater Offset ¹	ON/OFF	ON	14

¹U.S.A./ Canada/ Europe only

OPERATING THROUGH REPEATERS

Compared to simplex communication, you can usually transmit over much greater distances by using a repeater. Repeaters are typically located on a mountain top or other elevated location. Often they operate at higher ERP (Effective Radiated Power) than a typical station. This combination of elevation and high ERP allows communications over considerable distances.

Repeaters are often installed and maintained by radio clubs, sometimes with the cooperation of local businesses involved in the communications industry. During emergencies, repeater networks can be a valuable aid to officials responsible for coordinating communications in a community.

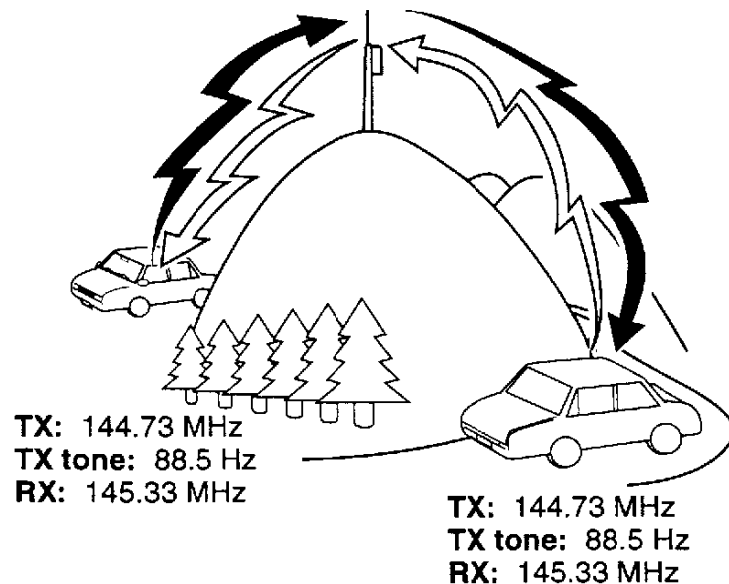

REPEATER ACCESS

Most Amateur Radio voice repeaters use a separate receive and transmit frequency. You can set a separate transmit frequency by selecting the offset frequency and offset direction with respect to the receive frequency.

In addition, some repeaters may require the transceiver to transmit a tone before the repeater can be used. To transmit this required tone, activate the Tone function and select a tone frequency. The required tone frequency depends on the repeater you are accessing. Consult your local repeater reference.

6

Flow Chart for Repeater Access

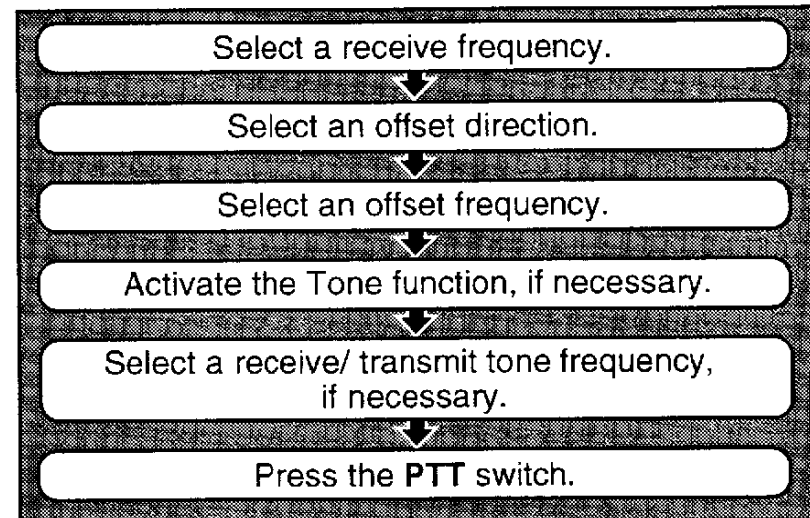

■ Selecting Offset Direction

Select whether the transmit frequency will be higher (+) or lower (-) than the receive frequency.

Press [F], [#].

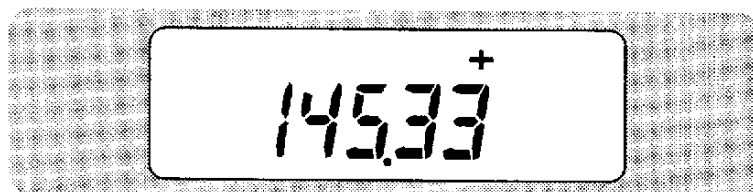

- Each time you repeat this key operation, the offset direction changes as shown below. The default is "simplex" (no offset).

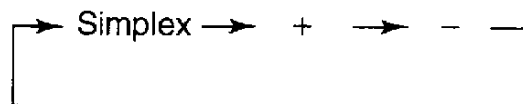

Note:

- ◆ If the offset transmit frequency falls outside the allowable transmit frequency range, transmitting is inhibited until the transmit frequency is brought within the band limits by one of the following methods:
 - Move the receive frequency further inside the band.
 - Change the offset direction.
- ◆ While using a split memory channel or transmitting, you cannot change the offset direction.

■ Selecting Offset Frequency

Select how much the transmit frequency will be offset from the receive frequency.

1 Press [F], [0].

- The current offset frequency appears. The default is 600 kHz.

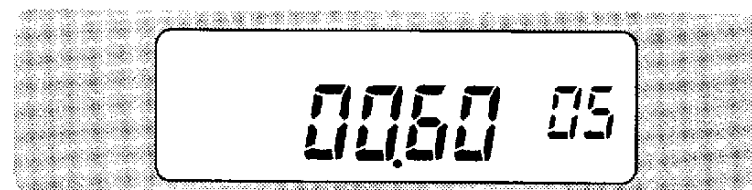

2 Turn the **Tuning** control to select the appropriate offset frequency.

- The selectable range is from 00.000 MHz to 29.995 MHz, and the current transmit/ receive frequency step size {page 35} is used.
- To change offset frequencies in steps of 1 MHz, press [B]. Press [B] again to cancel this function.

3 Press any key other than [MONI], [B], and [D] to complete setting.

Note: After changing the offset frequency, the new offset frequency will also be used by Automatic Repeater Offset.

■ Activating Tone Function

Press **[A]** to toggle the Tone function ON or OFF.

- "T" appears when the function is ON.

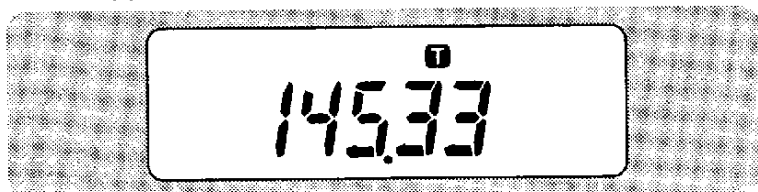

TH-235E only: If you have selected 1750 Hz tone frequency:

- You need not switch the Tone function ON. Pressing **[A]** after selecting 1750 Hz tone causes an error beep to sound.
- Press and hold the **PTT** switch, then press **[F]** to send a 1750 Hz tone. Release **[F]** to quit 1750 Hz transmission.

■ Selecting a Tone Frequency

1 Press **[F]**, **[A]**.

- The current receive/ transmit tone frequency appears. The default is 88.5 Hz.



2 Turn the **Tuning** control to select the appropriate receive/ transmit tone frequency.

- The frequencies listed in the table below are selectable.

3 Press any key other than **[MONI]** and **[D]** to complete the setting.

To select a separate receive and transmit tone frequency for the CTCSS function {page 25}, install the optional TSU-8 unit {page 43}, then proceed to the subsequent steps.

4 Press **[F]**, **[6]**.

- The current receive tone frequency appears. The default is OFF.

5 Turn the **Tuning** control to select the appropriate receive tone frequency.

- The frequencies listed in the following table are selectable.
- The tone frequency that you selected in step 2 is used for transmitting.

6

6 Press any key other than **[MONI]** and **[D]** to complete the setting.

Freq. (Hz)	Freq. (Hz)	Freq. (Hz)	Freq. (Hz)
67.0	97.4	136.5	192.8
71.9	100.0	141.3	203.5
74.4	103.5	146.2	210.7
77.0	107.2	151.4	218.1
79.7	110.9	156.7	225.7
82.5	114.8	162.2	233.6
85.4	118.8	167.9	241.8
88.5	123.0	173.8	250.3
91.5	127.3	179.9	1750 ¹
94.8	131.8	186.2	

¹1750 Hz: European versions only

■ **Automatic Repeater Offset
(U.S.A./ Canada/ Europe Only)**

This function automatically selects an offset direction according to the operating frequency that you select. The transceiver is programmed for offset directions as shown below. To obtain an up-to-date band plan for repeater offset direction, contact your national Amateur Radio association.

U.S.A. and Canada versions

This complies with the standard ARRL band plan.

6

144.0 145.5 146.4 147.0 147.6
145.1 146.0 146.6 147.4 148.0 MHz

S	-	S	+	S	-	+	S	-
---	---	---	---	---	---	---	---	---

S: Simplex

European versions

144.0 145.6 145.8 146.0 MHz

S	-	S
---	---	---

S: Simplex

Note: Automatic Repeater Offset does not function when Reverse is ON. However, switching Reverse ON after Automatic Repeater Offset has selected an offset (split) status, exchanges the receive and transmit frequencies.

- 1 Press [*] to enter Menu mode.
- 2 Select Menu No. 12.

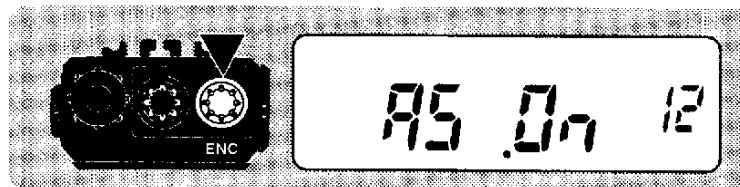

- 3 Press [F] to toggle the function ON (default) or OFF.

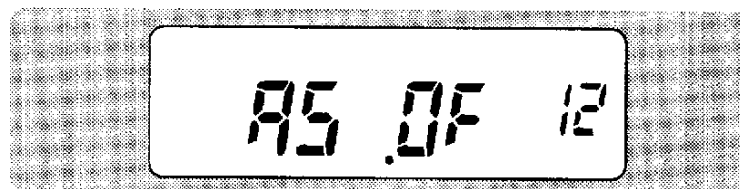

- 4 Press any key other than [MONI], [F], and [D] to exit Menu mode.

REVERSE FUNCTION

When used while monitoring a repeater, the Reverse function allows you to manually check the signal strength of a station accessing the repeater. If the station's signal is strong, it is best to move to a simplex frequency to continue the contact and free up the repeater.

Press [#] to toggle the Reverse function ON or OFF.

- The receive frequency and the transmit frequency are exchanged.
- "R" appears when the function is ON.

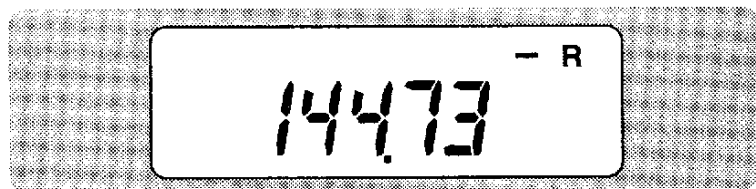

6

Note:

- ◆ If pressing [#] places the transmit frequency outside the allowable transmit frequency range, an error beep sounds when the **PTT** switch is pressed, and transmission is inhibited.
- ◆ If reversal would place the receive frequency outside the receive frequency range, an error beep sounds when [#] is pressed. No reversal occurs.
- ◆ Automatic Repeater Offset does not function while Reverse is ON.
- ◆ You cannot switch Reverse ON or OFF while transmitting.
- ◆ Pressing [#] does not exchange a separate transmit and receive tone frequency.

MEMORY CHANNELS

SIMPLEX OR SPLIT MEMORY CHANNEL?

A total of 60 memory channels (00 ~ 59) are available for storing frequencies and related data.

There are 2 methods of storing transmit/ receive frequencies and related data in memory channels, depending on the relationship of the transmit and receive frequencies. You can use each memory channel either as a simplex channel or split channel. Use as a split channel to store a separate receive and transmit frequency.

- Simplex memory channels:
RX frequency = TX frequency
- Split memory channels:
RX frequency \neq TX frequency

7

The data listed below can be stored in each memory channel:

Parameter	Simplex Channel	Split Channel
RX frequency	Yes	Yes
TX frequency		Yes
RX/ TX tone frequency	Yes	Yes
Tone status	Yes	Yes
RX tone frequency	Yes	Yes
CTCSS frequency	Yes	Yes
CTCSS status	Yes	Yes
Frequency step	N/A	N/A
Offset direction, Offset status	Yes	N/A
Reverse status	Yes	N/A
DTSS code, DTSS status	Yes	Yes
Memory channel lockout	Yes	Yes

Yes: Can be stored in memory.

N/A: Not applicable

STORING DATA IN SIMPLEX CHANNELS

- 1 Select the desired frequency and related data (Tone, CTCSS, DTSS, etc.) using VFO mode or Memory Recall {page 19}.
- 2 Press [F].
 - A memory channel number and an arrow appear.

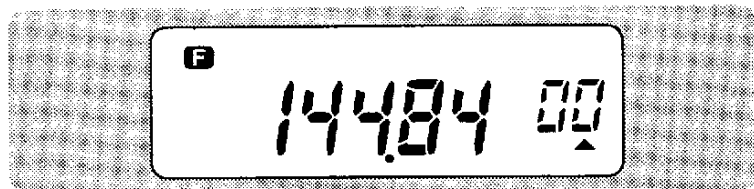

- 3 Turn the **Tuning** control to select the desired memory channel.
 - Blinking "▲" indicates that the channel contains no data.
- 4 Press [MR].
 - The selected frequency and related data are stored in the memory channel. The transmit frequency from a split memory channel is not stored.
 - If the memory channel selected in the previous step already contained data, the new data overwrites the previous data.

STORING DATA IN SPLIT CHANNELS

- 1 To select the desired receive frequency and related data, use steps 1 to 4 given for Simplex Memory Channels.
- 2 Select the desired transmit frequency.
- 3 Press [F].
- 4 Turn the **Tuning** control to select the memory channel that you selected in step 1.
- 5 Press [PTT]+[MR].
 - The selected transmit frequency is stored in the memory channel.

Note: Transmit Offset status and Reverse status are not stored in a split memory channel.

CONTINUOUSLY STORING IN SIMPLEX OR SPLIT CHANNELS

Using the following procedure will be easier to sequentially store frequencies and related data in more than one simplex or split memory channel.

- 1 Press **[PTT]+[MONI]+ POWER ON**.

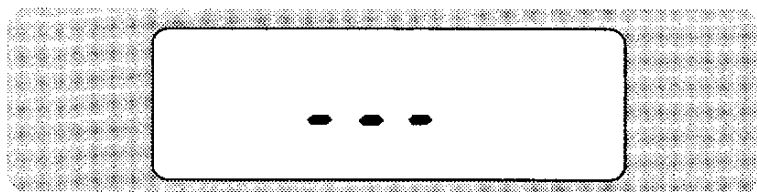

- 2 Press **[2], [0]** to enter Continuous Memory Storage mode.

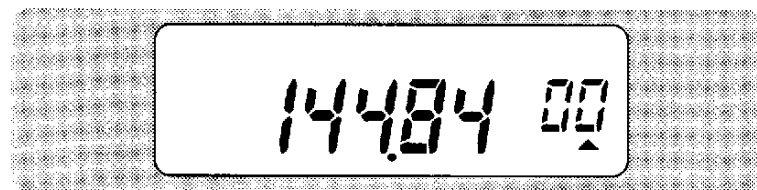

- 3 Press **[*]**, then turn the **Tuning** control to select the desired frequency and as required select related data (Tone, CTCSS, DTSS, etc.).
- 4 Press **[*]** again, then turn the **Tuning** control to select the desired memory channel.
 - Pressing **[*]** toggles frequency select or channel select.
 - Blinking "▲" indicates that the channel contains no data.

- 5 Press **[MR]**.
 - The selected frequency and related data are stored in the memory channel, and the memory channel number is incremented.

To also store a transmit frequency, proceed to step 6; otherwise proceed to step 10.

- 6 Press **[*]**, then turn the **Tuning** control to select the desired transmit frequency.
 - The frequency selected in step 3 will be used as a receive frequency.
- 7 Press **[*]**, then turn the **Tuning** control to select the memory channel that you selected in step 4.
- 8 Press **[F]**.
- 9 Press **[PTT]+[MR]**.
 - The selected transmit frequency is stored in the memory channel, and the memory channel number is incremented.
- 10 Repeat steps 3 to 5 (simplex) or 3 to 9 (split) to sequentially store in memory channels.
 - Turn the transceiver power OFF, then ON to exit Continuous Memory Storage mode.

Note:

- ◆ If you use Keypad Direct Entry (page 34) to select a frequency in step 3 or 6, you need not press **[*]**.
- ◆ Transmit Offset status and Reverse status are not stored in a split memory channel.
- ◆ You cannot start Continuous Storage mode when in Channel Display mode.
- ◆ You cannot start Menu mode when in Continuous Memory Storage mode.

RECALLING MEMORY CHANNELS

- 1 Press **[MR]** to enter Memory Recall mode.
 - The memory channel used last is recalled.

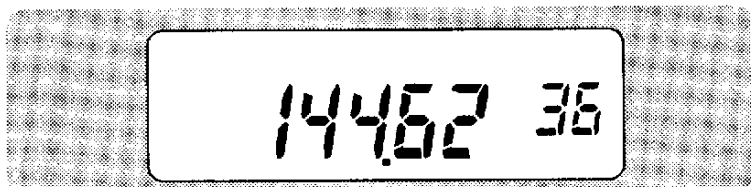

- 2 Turn the **Tuning** control to select the desired memory channel; clockwise to increase the channel number or counterclockwise to decrease the channel number.
 - You cannot recall empty memory channels.
 - To restore VFO mode, press **[VFO]**.

Note:

- ◆ You can also recall memory channels by directly entering numeric keys. See "Memory Channel Number Entry" (page 34).
- ◆ When you recall a split memory channel, "+" and "-" appear on the display. Press **[#]** to display the transmit frequency.

CLEARING MEMORY CHANNELS

- 1 Press **[MR]** to enter Memory Recall mode.
- 2 Turn the **Tuning** control to select the desired memory channel.
- 3 Switch OFF the power to the transceiver.
- 4 Press **[MR]+ POWER ON**.
 - The contents of the selected memory channel are erased.

MEMORY → VFO TRANSFERS

Transferring the contents of a memory channel to the VFO can be useful if you want to search for other stations or a clear frequency, near the selected memory channel.

7

- 1 Recall the desired memory channel.
- 2 Press **[F]**, **[VFO]**.
 - The complete contents of the memory channel are copied to the VFO. VFO mode is selected after the transfer is completed.

Note: A transmit frequency from a split memory channel is not transferred to the VFO. To transfer a transmit frequency, press **[#]**, then press **[F]**, **[VFO]**.

CLONE

If you have more than one TH-235A or TH-235E transceiver, you can easily copy the total contents of all memory channels to one of these transceivers, using this function.

- 1 On the source transceiver select any transmit frequency.
- 2 On the source transceiver press **[PTT]+[MONI]+POWER ON**.

7

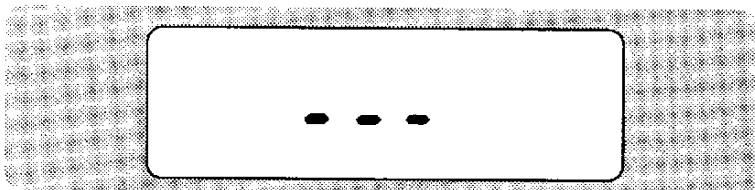

- 3 On the source transceiver press **[3], [#]** to enter Clone mode.

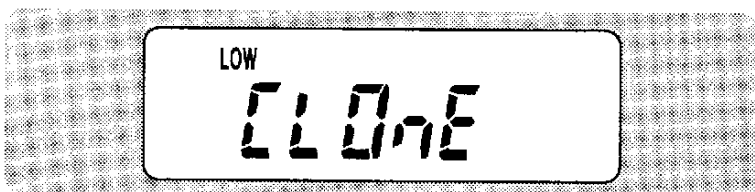

- 4 On the target transceiver(s) match the frequency with the source transceiver.
- 5 On the target transceiver(s) press **[PTT]+[MONI]+POWER ON**.
- 6 On the target transceiver(s) press **[3], [#]** to enter Clone mode.

- 7 On the source transceiver press the **PTT** switch to start data transfer.

- Low transmit power is automatically selected.
- The source transceiver restores the frequency display when it finishes data transfer.
- The target transceiver(s) finishes receiving data and restores the frequency display when its memory channels become full.

Note:

- ◆ Depending on countries, it is illegal to copy to transceivers owned by other stations. Check with the appropriate local regulations.
- ◆ If the power of either the source transceiver or the target transceiver(s) is accidentally switched OFF during data transfer, data stored in the transceivers may be damaged.

CHANNEL DISPLAY FUNCTION

When this function is switched ON, the transceiver displays only memory channel numbers instead of frequencies. To use this function, first store frequencies in memory channels.

- 1 Press **[PTT]+[MONI]+ POWER ON**.

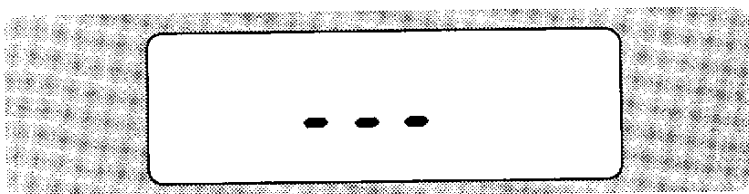

- 2 Press **[1], [*]** to enter Channel Display mode.

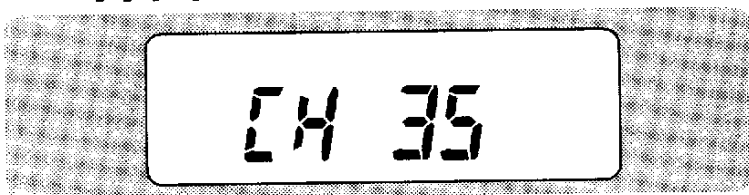

- 3 To quit Channel Display mode, repeat step 1 then step 2.

INITIALIZING MEMORY

If your transceiver seems to be malfunctioning, initializing the transceiver may resolve the problem. In addition, initialization is a quick way to erase all data from all channels.

Note: While using the Channel Display or Key Lock function, you cannot do Partial Reset nor Full Reset.

Defaults

Version	VFO Frequency	Frequency Step Size	RX/ TX Tone Frequency
U.S.A./ Canada	144 MHz	5 kHz	88.5 Hz
Europe	144 MHz	12.5 kHz	1750 Hz
General	144 MHz	12.5 kHz	88.5 Hz

■ Partial Reset (VFO)

Use to initialize all settings except the memory channels and Memory Channel Lockout.

Press **[VFO]+ POWER ON**.

- All indicators appear.
- Releasing **[VFO]** does Partial Reset.

■ Full Reset (Memory)

Use to initialize all settings.

Press **[F]+ POWER ON**.

- All indicators appear.
- Releasing **[F]** does Full Reset.

7

SCAN

Scan is a useful feature for hands-off monitoring of your favorite frequencies. After becoming comfortable with how to use Scan, the monitoring flexibility gained will increase your operating efficiency. This transceiver provides the following two types of Scan:

VFO Scan:

Monitors all tunable frequencies.

Memory Scan:

Monitors frequencies stored in the memory channels.

When using with CTCSS and/or DTSS:

- While using CTCSS, Scan stops and the squelch opens only when received signals contain the matching CTCSS tone.
- While using DTSS, Scan stops for any signals received. However, if the signals do not contain the matching DTSS code, the squelch does not open.
- When both CTCSS and DTSS are ON, Scan stops for signals that contain the matching CTCSS tone. However, if the signals do not also contain the matching DTSS code, the squelch does not open.

Note: Adjust the squelch level before using Scan.

SCAN RESUME METHODS

Before using Scan, it's necessary to decide under what condition you want your transceiver to continue scanning after detecting and stopping for a signal. You can choose Time-Operated mode or Carrier-Operated mode. The default is Time-Operated mode.

• **Time-Operated mode**

Your transceiver stops scanning after detecting a signal, remains there for approximately 5 seconds, and then continues to scan even if the signal is still present.

• **Carrier-Operated mode**

Your transceiver stops scanning after detecting a signal and remains on the same frequency until the signal drops out. There is a 2 second delay between signal drop-out and scan resumption.

Note:

- ◆ Pressing [**MONI**] causes scanning to stop and squelch to open no matter which resume method you select. When you release [**MONI**], scanning resumes.
- ◆ Turning the **Tuning** control clockwise after a signal that has stopped Scan drops out, causes scanning to resume immediately upward.
- ◆ Turning the **Tuning** control counterclockwise after a signal that has stopped Scan drops out, causes scanning to resume immediately downward.

■ Selecting Scan Resume Method

- 1 Press [*****] to enter Menu mode.
- 2 Select Menu No. 3.

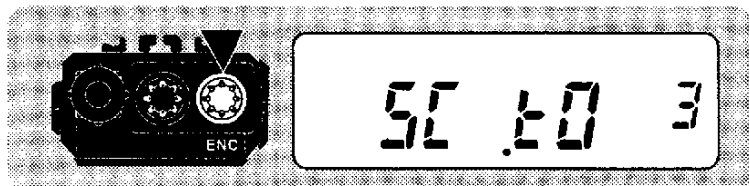

- 3 Press [**F**] to toggle Time-Operated (default) or Carrier-Operated.
- 4 Press any key other than [**MONI**], [**F**], and [**D**] to exit Menu mode.

VFO SCAN

VFO Scan allows you to scan all frequencies from the lowest frequency to the highest frequency on the band. This Scan uses the current frequency step size.

- 1 Press [**VFO**] (1 s).
 - The 1 MHz decimal starts blinking.
 - Scan starts at the frequency currently displayed.
- 2 To reverse the scan direction, turn the **Tuning** control.
 - Upward scan: Turn the **Tuning** control clockwise.
 - Downward scan: Turn the **Tuning** control counterclockwise
- 3 To quit VFO Scan, press any key other than [**MONI**] and [**D**].

MEMORY SCAN

Memory Scan allows all memory channels containing data to be scanned.

- 1 Press **[MR]** (1 s).
 - The 1 MHz decimal starts blinking.
 - Scan starts with the channel last recalled.
- 2 To reverse the scan direction, turn the **Tuning** control.
 - Upward scan: Turn the **Tuning** control clockwise.
 - Downward scan: Turn the **Tuning** control counterclockwise.
- 3 To quit Memory Scan, press any key other than **[MONI]** and **[D]**.

Note:

8

- ◆ At least 2 or more memory channels must contain data and must not be locked out.
- ◆ You can also start Memory Scan when in Channel Display mode.

■ Locking Out Memory Channels

Memory channels that you prefer not to monitor while scanning can be locked out. Lock out any memory channel with the following procedure:

- 1 Press **[MR]** to enter Memory Recall mode.
- 2 Turn the **Tuning** control to select the desired memory channel.
- 3 Press **[F]**, **[9]** to toggle Lockout ON or OFF.
 - “★” appears under the memory channel number that was locked out.

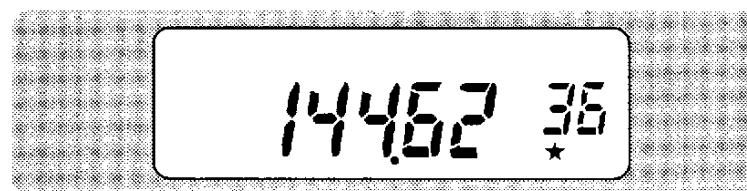

CONTINUOUS TONE CODED SQUELCH SYSTEM (CTCSS)

CTCSS is available only when the optional TSU-8 unit is installed {page 43}. CTCSS uses a subaudible tone to control the squelch of transceivers, and by using this system you can reject signals from undesired stations.

Suppose that stations "A", "B", and "C" are programmed as follows:

Example 1:

"A": 91.5 Hz (RX/TX)

"B": 91.5 Hz (RX/TX)

"C": 100.0 Hz (RX/TX)

To communicate with only "A" and "B", select 91.5 Hz RX/TX tone frequency.

Example 2:

"A": 100.0 Hz (RX)/ 91.5 Hz (TX)

"B": 103.5 Hz (RX)/ 91.5 Hz (TX)

"C": 107.2 Hz (RX/TX)

Select 91.5 Hz RX and 100.0 Hz TX tone frequencies to communicate with only "A", or 91.5 Hz RX and 103.5 Hz TX tone frequencies to communicate with only "B".

USING CTCSS

- 1 Select the desired receive (RX) and transmit (TX) tone frequencies {page 13}.
- 2 Press **[F]**, **[3]** to toggle the CTCSS function ON or OFF.
 - "CT" appears when CTCSS is ON.

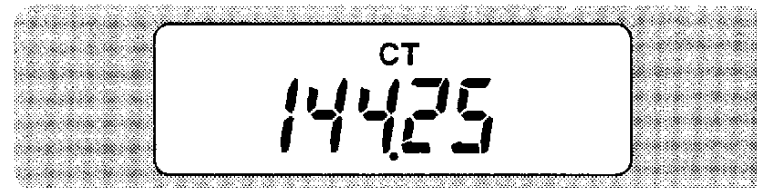

3 When you are called:

The squelch of your transceiver opens only when the selected RX tone is received.

When you make a call:

Press and hold the **PTT** switch.

- The selected TX tone is superimposed on your transmitted signal.

Note: When using DTSS with CTCSS, the squelch opens only if the correct tone is received and the received DTSS code matches the code stored in your transceiver.

TH-235E only: After selecting 1750 Hz tone frequency, you cannot switch the CTCSS function ON.

DUAL TONE SQUELCH SYSTEM (DTSS)

DTSS provides a more refined method than CTCSS to selectively communicate with specific stations. The squelch on your transceiver opens only when the 3-digit DTMF (Dual Tone Multi-Frequency) code received matches the code programmed on your transceiver. You can select a 3-digit code from among 1000 combinations, 000 to 999.

By transmitting a Group code such as "12A" or "3AA", you can simultaneously pass information to a number of stations. Select A, B, C, D, E, or F for a wildcard by using Menu Set-up.

Suppose that stations "A", "B", "C", "D", and "E" are programmed as follows. The letters in the parentheses are wildcards. The accompanying table shows relationships between your DTSS codes and stations that you can call.

"A"	123 (B)
"B"	124 (B)
"C"	133 (B)
"D"	223 (B)
"E"	223 (C)

Your Code	Stations That You Can Call
223	"D" {223 (B)}, "E" {223 (C)}
12B (B)	"A" {123 (B)}, "B" {124 (B)}
1B3 (B)	"A" {123 (B)}, "C" {133 (B)}
B23 (B)	"A" {123 (B)}, "D" {223 (B)}
1BB (B)	"A" {123 (B)}, "B" {124 (B)}, "C" {133 (B)}
BBB (B)	"A", "B", "C", "D"

Note:

- ◆ DTSS does not function while you are storing DTSS codes even if a code is received that matches one already stored in memory.
- ◆ Each time you press the PTT switch, the DTSS code is transmitted for about 0.5 seconds. After establishing a contact, you can eliminate this by switching the DTSS function OFF.
- ◆ DTSS may not function in the following situations:
 - The other station is using a battery saver function.
 - A repeater ID and the DTSS code are received simultaneously.
 - Any key is pressed while a valid DTSS code is being received.
- ◆ Both a DTSS status and a DTSS code can be stored in a memory channel.

STORING DTSS CODES

- 1 Press **[F]**, **[4]**.
 - The current DTSS code appears. The default is 000.



- 2 Use the keypad to enter 3 digits in sequence.
 - The setting is completed and the previous display is restored.
 - To program a Group code, refer to "STORING DTMF NUMBERS FOR AUTOMATIC DIALER" {page 30} and use one of the DTMF memory channels.

If you programmed a Group code, proceed to the subsequent steps.

- 3 Press **[*]** to enter Menu mode.
- 4 Select Menu No. 11.

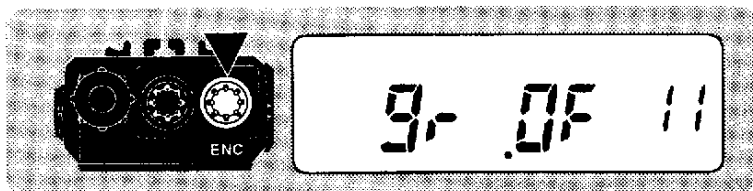

- 5 Press **[F]** to select A, B, C, D, E, F, or OFF (default).
- 6 Press any key other than **[MONI]**, **[F]**, and **[D]** to exit Menu mode.

USING DTSS

- 1 Select the appropriate DTSS code.
- 2 Press **[F]**, **[1]** to switch the DTSS function ON.
 - "DT" appears.

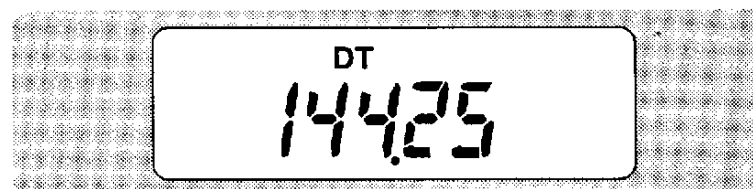

- 3 **When you are called:**

The squelch of your transceiver opens only when the stored DTSS code is received.

- If, after DTSS has opened the squelch, no signal is received for more than 2 seconds, the squelch will close.

When you make a call:

Press and hold the **PTT** switch to transmit your DTSS code.

- To transmit a Group code, refer to "MAKING DTMF CALLS" {page 29} or "TRANSMITTING STORED DTMF NUMBERS" {page 31}. When you press the **PTT** switch, the transceiver first transmits the DTSS code that you stored in step 2 under "STORING DTSS CODES".

- 4 To switch the DTSS function OFF, press **[F]**, **[1]** again.

■ DTSS and Repeaters

Pressing the **PTT** switch transmits the DTSS signal after a short delay. When using repeaters with long response times, this delay helps the repeater avoid losing a portion of the DTSS code. The delay time is 350 ms during simplex operation.

When using a transmit offset or a split frequency, you can select either 350 ms (default) or 550 ms.

- 1 Press [*****] to enter Menu mode.
- 2 Select Menu No. 7.

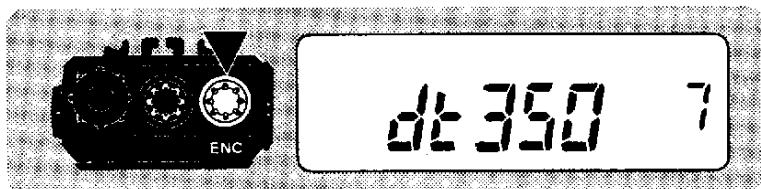

- 3 Press [**F**] to toggle 350 ms (default) or 550 ms.
- 4 Press any key other than [**MONI**], [**D**], and [**F**] to exit Menu mode.

DUAL TONE MULTI-FREQUENCY (DTMF) FUNCTIONS

You can send DTMF tones by using the DTMF keys on the keypad. The keypad includes the 12 keys found on a push-button telephone plus an additional 4 keys (A, B, C, D). These additional keys are required for various control operations by some repeater systems.

MAKING DTMF CALLS

- 1 Press and hold the **PTT** switch.
- 2 Press the keys in sequence on the keypad to send DTMF tones.
 - The corresponding DTMF tones are transmitted.

Freq. (Hz)	1209	1336	1477	1633
697	1	2	3	A
770	4	5	6	B
852	7	8	9	C
941	*	0	#	D

■ DTMF Tone TX Hold

This function makes the transceiver remain in the transmit mode for 2 seconds after you release each key. So you can release the **PTT** switch after beginning to press keys.

- 1 Press [*****] to enter Menu mode.
- 2 Select Menu No. 8.

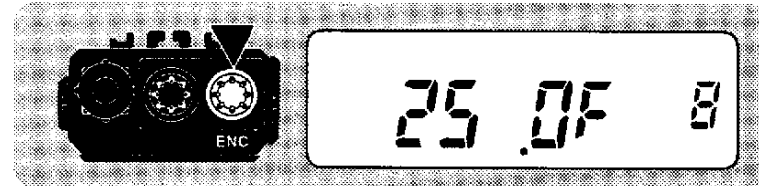

- 3 Press [**F**] to toggle the function ON or OFF (default).
- 4 Press any key other than [**MONI**], [**F**], and [**D**].

■ Autopatch (U.S.A. and Canada)

Some repeaters in the U.S.A. and Canada offer a service called Autopatch. Autopatch allows you to access the public telephone network by sending DTMF tones. Some repeaters require a special key sequence to activate Autopatch. Check with the repeater control operator.

STORING DTMF NUMBERS FOR AUTOMATIC DIALER

To store a DTMF number with a maximum of 16 digits in any of 5 dedicated DTMF memory channels, follow the procedure below.

Note:

- ◆ Audible DTMF tones from other transceivers near you may be picked up by your microphone. If so, this could prevent the function from working correctly.
- ◆ DTSS does not function while you are storing a DTMF number even if a DTSS code is received that matches one already stored in memory.

1 Press [F], [5].

- The display for entering a DTMF number appears.

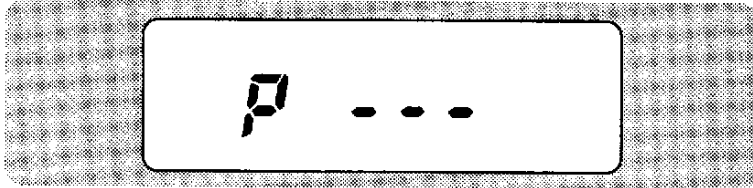

2 Use the keypad to enter the digits of the number to be stored.

- The corresponding DTMF tones are heard.
- If you enter an incorrect digit, press [VFO] to erase all digits entered.

3 Press [MR] to complete entry.

- A bar appears between "P" and the entered number.

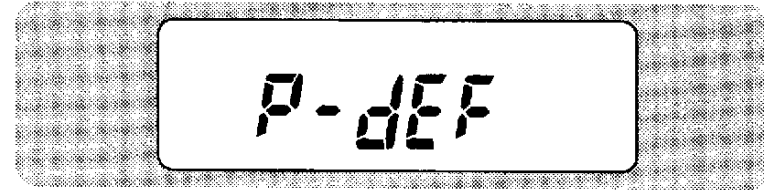

4 Press a numeric key 1 to 5 to select the desired channel.

- The entered number is stored in the selected channel.

CONFIRMING STORED DTMF NUMBERS

1 Press [F], [2].

- The display for confirming DTMF numbers appears.

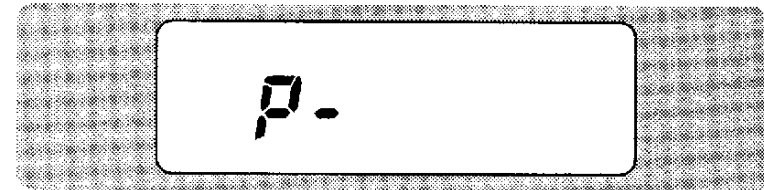

2 Press a single key [1] to [5] to select the desired channel.

- The number stored in the channel scrolls across the display accompanied by DTMF tones from the speaker.
- After the scrolling is completed, the frequency display is restored.

TRANSMITTING STORED DTMF NUMBERS

To transmit a stored DTMF number, follow the procedure below.

- 1 Press **[PTT]+[MR]**.
 - The display for selecting a DTMF memory channel appears.

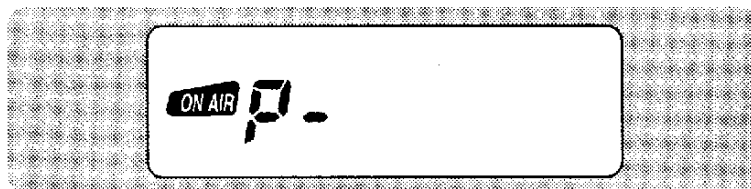

- 2 While holding down the **PTT** switch, press **[1]** to **[5]** to select the desired channel.
 - The number stored in the channel scrolls across the display accompanied by DTMF tones from the speaker.
 - After the transmission, the frequency display is restored.

TRANSMITTING SINGLE-FREQUENCY TONES

Use the following procedures to transmit single-frequency tones.

- 1 Press **[PTT]+[VFO]** to enter Single-Frequency Tone mode, then release **[VFO]**.
- 2 While holding down the **PTT** switch, press **[1]** to **[8]** to transmit the desired tone.
 - Without releasing the **PTT** switch, press **[VFO]** to toggle Single-Frequency Tone mode or Dual-Frequency Tone mode.
- 3 Release the **PTT** switch to exit Single-Frequency Tone mode.

Key	Frequency (Hz)	Key	Frequency (Hz)
1	697	5	1209
2	770	6	1336
3	852	7	1477
4	941	8	1633

AUXILIARY FUNCTIONS

TIME-OUT TIMER (TOT)

It is sometimes necessary or desirable to restrict a single transmission to a specific maximum time. This feature can be useful when accessing repeaters to prevent repeater time-outs, or when trying to conserve battery power.

Access Menu No. 10 to select from 900 (default), 180, 90, 60, and 30 seconds.

When TOT times out, the transceiver generates beeps and automatically returns to receive mode. To resume transmitting, release and then press the **PTT** switch again.

TX INHIBIT

You can disable the TX function to prevent unauthorized individuals from transmitting, or to eliminate the risk of yourself accidentally transmitting.

Access Menu No. 5 to toggle TX Inhibit ON or OFF (default).

BUSY CHANNEL LOCKOUT

This function prevents you from interfering with other stations that may be using the channel that you select. Pressing the **PTT** switch while the selected channel is in use causes your transceiver to generate an error beep; your transceiver does not transmit.

Access Menu No. 9 to toggle the function ON or OFF (default).

TRANSCEIVER LOCK

This function prevents unauthorized individuals from changing the transceiver settings.

Press **[F]**, **[B]** to toggle the function ON or OFF.

- A key icon appears when the function is ON.

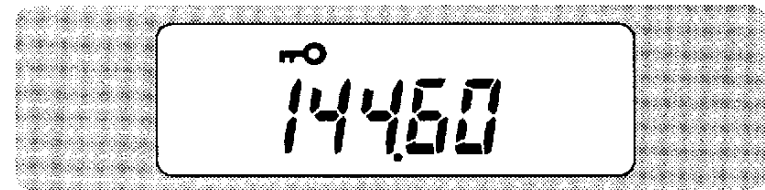

You may want to use the **Tuning** control when in Transceiver Lock mode. Access Menu No. 6 to toggle the function ON or OFF (default).

AUTOMATIC POWER OFF (APO)

Automatic Power Off is a background function that monitors whether any keys have been pressed, or whether the **Tuning** control has been turned. After 1 hour passes with no operations, APO turns OFF the power. However, 1 minute before the power turns OFF, "APO" appears and blinks, and a series of warning tones sound.

Access Menu No. 2 to toggle the function ON or OFF (default).

Note: If the squelch opens or any settings are changed during the 1 hour period while APO is ON, the timer resets. When the squelch closes or you stop changing the settings, the timer begins counting again from 0.

BATTERY SAVER

Battery Saver becomes active when the squelch is closed and no key is pressed for more than 10 seconds. This function becomes passive whenever the squelch is opened or any key is pressed.

Access Menu No. 1 to toggle the function ON (default) or OFF.

LAMP FUNCTION

You can illuminate the transceiver display by pressing **[D]**. Approximately 5 seconds after releasing **[D]**, the light goes OFF if no other key is pressed. Pressing any key other than **[D]** while the display is lit restarts the 5 second timer; pressing **[D]** turns OFF the light immediately.

To latch the light ON, press **[F]**, **[D]**. The display remains lit until you press **[F]**, **[D]** again.

BEEP ON/OFF

The transceiver beeps each time you press a key on the keypad. You can also switch this function OFF.

Access Menu No. 4 to toggle the function ON (default) or OFF.

KEYPAD DIRECT ENTRY

You can select the desired operating frequency or memory channel by entering digits directly from the keypad.

■ Frequency Entry

- 1 Press **[VFO]** to enter VFO mode.
- 2 Press the numeric keys in sequence on the keypad.
 - Enter the digits in order from the most significant down to the least significant.
 - When the current step size is 5 kHz, 10 kHz, 15 kHz, 20 kHz, 50 kHz, or 100 kHz, make entry down to the 1 kHz digit. Enter either 0 or 5 for the 1 kHz digit.

Note:

- ◆ If you do not make the next entry within 10 seconds, direct entry is canceled and the previous frequency is restored.
- ◆ Except for the 1 kHz digit, entering a digit that is outside the allowable range causes the nearest digit within range to be displayed. For the 1 kHz digit, pressing **[0]** ~ **[4]** selects "0" and pressing **[5]** ~ **[9]** selects "5".
- ◆ When the current step size is 12.5 kHz or 25 kHz, entering the 10 kHz digit completes frequency setting. The 10 kHz and subsequent digits are set according to which key is pressed for the 10 kHz digit as shown in the following table.

10 kHz Key	Frequency (kHz)	10 kHz Key	Frequency (kHz)
0	00	5	50
1	12.5	6	62.5
2	25	7	75
3	37.5	8	87.5
4	37.5	9	87.5

■ Memory Channel Number Entry

- 1 Press **[MR]** to enter Memory Recall mode.
 - The memory channel used last is recalled.
- 2 Press the numeric keys to enter a 2-digit memory channel number.
 - To recall channel 3, for example, enter "03".
 - If you enter a memory channel that does not contain data, an error beep sounds.

Note: If you do not make the next entry within 10 seconds after entering the first digit, the previous memory channel is restored.

CHANGING FREQUENCY STEP SIZE

Choosing the correct step size is essential in order to select your exact receive frequency using the **Tuning** control.

The default step size is 5 kHz (U.S.A./ Canada) or 12.5 kHz (Europe/ General).

1 Press [F], [7].

- The current step size appears.

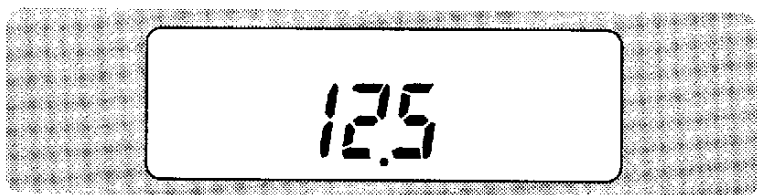

2 Turn the **Tuning** control to select the desired step size.

- The selectable step sizes are 5, 10, 15, 20, 12.5, 25, 50, and 100 kHz.

Changing between step sizes may result in a change of the displayed frequency. For example, assume 144.995 MHz is displayed with a 5 kHz step size selected. Changing to a 12.5 kHz step size alters the displayed frequency. See the accompanying tables.

5, 10, 15, 20, 50, or 100 kHz Step Size	→	12.5 or 25 kHz Step Size
Displayed Frequency (10 kHz/ 1 kHz)		Displayed Frequency (10 kHz/ 1 kHz)
00, 05, 10, 15		00
20, 25, 30, 35		25
40, 45, 50, 55		50
60, 65, 70, 75, 80, 85, 90, 95		75

12.5 or 25 kHz Step Size	→	5, 10, 15, 20, 50 or 100 kHz Step Size
Displayed Frequency (10 kHz/ 1 kHz)		Displayed Frequency (10 kHz/ 1 kHz)
00		00
12.5		10
25		20
37.5		30
50		50
62.5		60
75		70
87.5		80

MICROPHONE CONTROL

After connecting the optional SMC-33 or SMC-34 speaker microphone, you can change numerous transceiver settings without using the transceiver keys or controls. The 1, 2, and 3 keys located on the top of the microphone are programmable with the transceiver key (or key combination) function. The assigned default functions are as follows:

- [1] : [VFO] (VFO Select)
- [2] : [MR] (Memory Recall)
- [3] : [C] (Transmit Power Select)

1 Press one of the following key combinations depending on which key you want to re-program:

- Mic [1]+ **POWER ON** ("PF 1" appears)
- Mic [2]+ **POWER ON** ("PF 2" appears)
- Mic [3]+ **POWER ON** ("PF 3" appears)

2 Press a key or key combination on the transceiver that you want to assign.

- You can press the following keys.

- | | |
|----------------------------|----------------------|
| [MONI]: Monitor ON/OFF | [VFO]: VFO Select |
| [MR]: Memory Recall | [A]: Tone ON/OFF |
| [B]: 1 MHz function ON/OFF | [C]: TX Power Select |
| [D]: Lamp | [*]: Menu |
| [#]: Reverse ON/OFF | |

- To assign the Up function, rotate the **Tuning** control clockwise. To assign the Down function, rotate the **Tuning** control counterclockwise.

- You can also press the following key combinations:

- [F], [MONI]: Squelch Adjust
- [F], [VFO]: Memory → VFO
- [F], [MR]: Memory Channel Store¹
- [F], [A]: RX/TX Tone Frequency Select
- [F], [B]: Transceiver Lock ON/OFF
- [F], [D]: Lamp Latch ON/OFF
- [F], [#]: Offset Direction Select
- [F], [1]: DTSS ON/OFF
- [F], [2]: DTMF Number Confirm
- [F], [3]: CTCSS ON/OFF
- [F], [4]: DTSS Code Store
- [F], [5]: DTMF Number Store
- [F], [6]: RX Tone Frequency Select
- [F], [7]: Frequency Step Size Select
- [F], [9]: Memory Channel Lockout ON/OFF
- [F], [0]: Offset Frequency Select

¹Available in place of transceiver [MR] when storing data in memory channels (page 17).

Note:

- ◆ Turn OFF the transceiver power before connecting an option.
- ◆ If the **LOCK** switch located on the rear of the microphone is ON, you cannot re-program the Programmable Function keys.
- ◆ Pressing the **PTT** switch in step 2 assigns the VFO/MR switch.
- ◆ Pressing [0] to [9] in step 2 allows you to recall a memory channel number 0 to 9.
- ◆ Pressing the **PTT** switch, [C], [*], or [8] after pressing [F] will assign no function.

MAINTENANCE

GENERAL INFORMATION

Your transceiver has been factory aligned and tested to specification before shipment. All adjustable trimmers, coils and resistors in the transceiver were preset at the factory. They should only be readjusted by a qualified technician who is familiar with this transceiver and has the necessary test equipment. Attempting service or alignment without factory authorization can void the transceiver warranty.

SERVICE

When returning the equipment to your dealer or service center for repair, pack the transceiver in its original box and packing material. Include a full description of the problems experienced. Include both your telephone number and fax number (if available) along with your name and address in case the service technician needs to call you. Don't return accessory items unless you feel they are directly related to the service problem.

You may return your transceiver for service to the authorized **KENWOOD** dealer from whom you purchased it or any authorized **KENWOOD** service center. A copy of the service report will be returned with the transceiver. Please do not send subassemblies or printed circuit boards. Send the complete transceiver.

Tag all returned items with your name and call sign for identification. Please mention the model and serial number of the transceiver in any communication regarding the problem.

SERVICE NOTE

If you desire to correspond on a technical or operational problem, please make your note short, complete, and to the point. Help us help you by providing the following:

- 1 Model and serial number of equipment
- 2 Question or problem you are having
- 3 Other equipment in your station pertaining to the problem
- 4 Meter readings
- 5 Other information (Menu setup, mode, frequency, button sequence to induce malfunction, etc.)

CAUTION: DO NOT PACK THE EQUIPMENT IN CRUSHED NEWSPAPERS FOR SHIPMENT! EXTENSIVE DAMAGE MAY RESULT DURING ROUGH HANDLING OR SHIPPING.

Note:

- ◆ Record the date of purchase, serial number and dealer from whom the transceiver was purchased.
- ◆ For your own information, retain a written record of any maintenance performed on the transceiver.
- ◆ When claiming warranty service, please include a photocopy of the bill of sale, or other proof-of-purchase showing the date of sale.

CLEANING

Remove the controls from the transceiver when they become soiled and clean them with a neutral detergent and warm water. Use a neutral detergent (no strong chemicals) and a damp cloth to clean the case.

CHARGING THE NiCd BATTERY PACK

You must charge the battery pack before using it with the transceiver, or after storing the pack removed from the transceiver for more than 2 months. It takes several charge/ discharge cycles before achieving the full battery pack capacity.

Depending on the market, either a wall charger or a slot-type charger is provided.

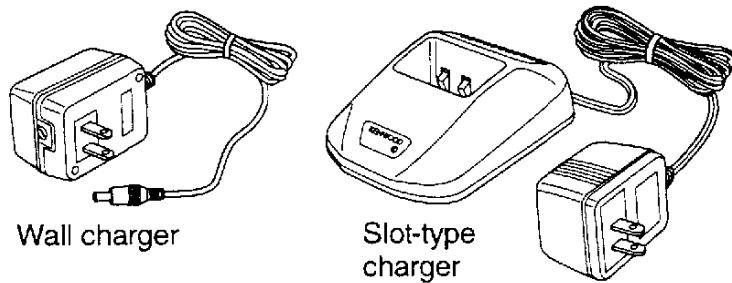

CAUTION:

- ◆ EXCEEDING THE SPECIFIED CHARGE PERIOD SHORTENS THE USEFUL LIFE OF THE NiCd BATTERY PACK.
- ◆ THE PROVIDED WALL CHARGER OR SLOT-TYPE CHARGER CAN BE USED FOR ONLY THE SAME MODELS AS THE PROVIDED NiCd BATTERY PACK. CHARGING OTHER MODELS OF BATTERY PACKS WILL DAMAGE THE CHARGER AND BATTERY PACKS.

Note:

- ◆ Charging should be done within an ambient temperature between 5°C to 40°C (41°F to 104°F). Charging outside this range may not fully charge the battery.
- ◆ Always switch OFF the transceiver equipped with the NiCd battery pack before charging the transceiver. Using the transceiver while charging its battery pack will interfere with correct charging.

14

■ Using the Wall Charger

- 1 Install the NiCd battery pack onto the transceiver {page 2}.
 - Confirm that the transceiver power is OFF.
 - For the PB-37 battery pack, skip this step.
- 2 Insert the DC plug from the charger into the DC IN jack on the transceiver.
 - For the PB-37 battery pack, insert the DC plug from the charger into the DC IN jack on the battery pack. You cannot charge the PB-37 using the DC IN jack on the transceiver.

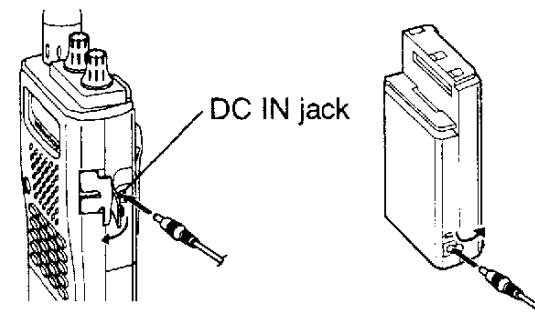

- 3 Insert the charger AC plug into an AC wall outlet.
 - Charging starts and will take approximately 25 hours (PB-37: approx. 15 hours).
- 4 After 25 hours (PB-37: 15 hours), remove the charger DC plug from the transceiver DC IN jack.
- 5 Remove the charger AC plug from the AC wall outlet.

■ Using the Slot-type Charger

- 1 Plug the AC adapter cable into the adapter jack located on the rear of the charger.

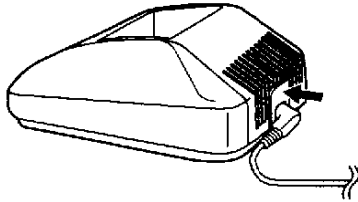

- 2 Plug the AC adapter into an AC wall outlet.
- 3 Slide the NiCd battery pack or the transceiver equipped with the battery pack into the charging slot.
 - Confirm that the transceiver power is OFF.
 - Make sure that the metal contacts on the pack mate securely with the charger terminals.
 - The indicator on the charger lights and charging starts. Charging will take approximately 13 hours.

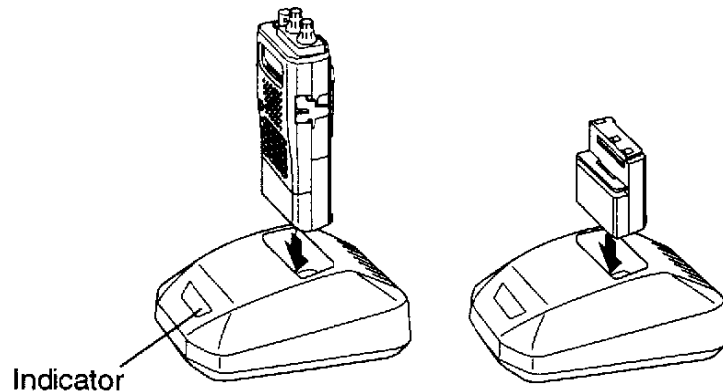

- 4 After 13 hours, remove the battery pack or the transceiver from the charging slot, or unplug the charger from the AC wall outlet.

Note:

- ◆ Repeatedly recharging a fully charged battery pack, or almost fully charged pack, shortens its operating time. To resolve this problem, use the pack until it is completely discharged. Then recharge the pack to full capacity.
- ◆ If the operating time of a battery pack decreases although the battery pack is fully and correctly charged, the battery pack life is over. Replace the battery pack.
- ◆ The provided slot-type charger cannot be used for an optional PB-37 NiCd battery pack.
- ◆ When using the optional KSC-8A or KSC-14 charger, charging will take the following amount of time (approx.):

	KSC-8A	KSC-14
PB-36	12 hours	1.5 hours
PB-37	18 hours	1.5 hours

TROUBLESHOOTING

The problems described in this table are commonly encountered operational malfunctions. These types of difficulties are usually caused by improper hook-up, accidental incorrect control settings, or operator error due to incomplete programming. These problems are usually not caused by circuit failure. Please review this table, and the appropriate section(s) of this instruction manual, before assuming your transceiver is defective.

Note: Unmodulated carriers may be received due to internal frequency relationships.

Problem	Probable Cause	Corrective Action	Page Ref.
Nothing appears on the display when the transceiver is switched ON, or the display is blinking ON and OFF.	1 Low supply voltage	1 Recharge the battery pack or replace the batteries.	3, 38
	2 If using the optional DC cable: a) Bad power cable or connections b) Open (blown) power supply fuse	2 a) Check power cable and connections, then correct/replace as necessary. b) Investigate the cause for the open fuse. Replace the fuse.	45 —
Most keys and the Tuning control do not function.	Transceiver Lock is ON (Key icon is visible).	Press [F] , [B] to switch OFF Transceiver Lock.	32
Memory channels cannot be recalled.	There is no data stored in any of the memory channels.	Store the desired frequencies in memory channels.	17
You cannot select the exact desired frequency using the Tuning control.	The current frequency step size needs to be changed.	Select the appropriate frequency step size.	35

Continued

Problem	Probable Cause	Corrective Action	Page Ref.
You cannot transmit even though you press the PTT switch.	1 You selected a frequency outside the allowable transmit frequency range.	1 Select a frequency within the allowable transmit frequency range.	9
	2 You selected a transmit offset that places the transmit frequency outside the allowable transmit frequency range.	2 Press [F] , [#] repeatedly so neither "+" nor "-" is visible.	12
The transceiver switches OFF for no apparent reason.	The Automatic Power Off (APO) function is ON.	Switch OFF the APO function	33
Packet operation results in no connects with other stations.	1 Physical connections between the transceiver, computer, and TNC are incorrect, or software settings in the TNC are wrong.	1 Recheck all connections using this manual, your TNC manual and your computer hardware manual as reference.	46
	2 Different transmit and receive frequencies are being used. Usually, you must use the same transmit and receive frequency for packet.	2 If using VFO mode, switch OFF the transmit offset. If using Memory Recall, select a simplex memory channel.	12, 16
	3 The modulation level from the TNC is incorrect.	3 Adjust the TNC modulation level according to the TNC manual.	—
	4 There is multi-path distortion.	4 Reorient the antenna. The strongest signal does not always provide the best operation on packet.	—

OPTIONAL ACCESSORIES

TSU-8
CTCSS Unit



SMC-32
Speaker Microphone



SMC-33
Remote Control
Speaker Microphone



SMC-34
Remote Control
Speaker Microphone

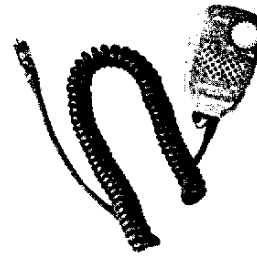

EMC-3
Clip Microphone
with Earphone



PB-36
Standard Battery
Pack
(7.2 V/ 950 mAh)



PB-37
High-power Battery
Pack
(12 V/ 950 mAh)



BT-10
Battery Case



BC-17
Wall Charger



KSC-8A
Compact Charger

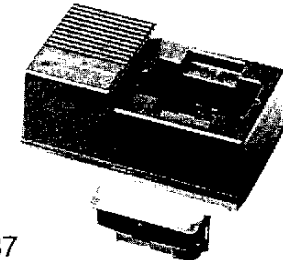

Not for use with the PB-37

KSC-14
Rapid Charger



PG-2W
DC Cable

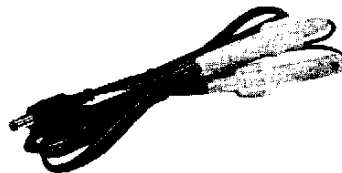

Not for use with the PB-37

PG-3J
Filtered Cigarette Lighter Cable



Not for use with the PB-37

WR-2
Water-resistant Bag



EQUIPMENT INSTALLATION AND CONNECTION

INSTALLING THE TSU-8 UNIT

Note: Switch OFF the power before installing the TSU-8 unit.

- 1 To remove the battery pack or battery case, hold the transceiver as shown, push up on the release switch, then slide the battery case back.

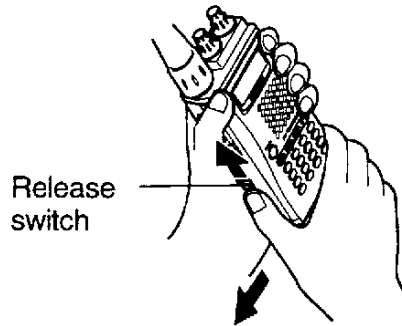

- 2 Remove the antenna, **VOL** control, and **Tuning** control, then remove the top rubber cover.

- Pull the antenna while twisting it and pull the controls straight.

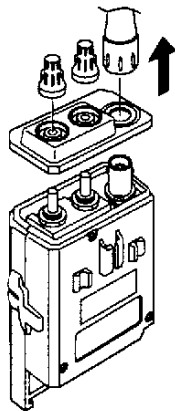

- 3 Open the DC IN jack cap, then remove the rear cover (3 screws).
- When removing the rear cover, first separate the lower part of the cover.

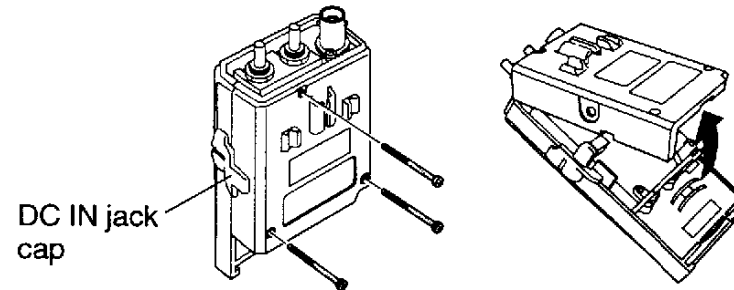

- 4 Remove the inner partition.

- First while lightly pushing the charging electrodes, pass them through the holes of the inner partition.

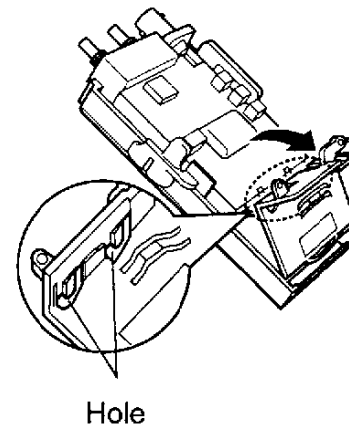

- 5 Remove the cover for the MIC/ SP/ DC IN jacks, then remove the inner assembly.

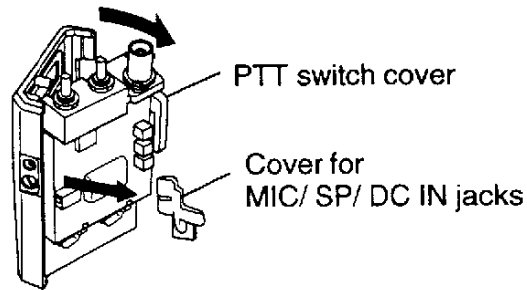

- 6 Hold the plastic tap of the TSU-8, and insert the unit into the CTCSS slot.
- Completely mate the edge connector on the TSU-8 with the connector in the transceiver.
 - The component side of the TSU-8 must face the rear of the transceiver.

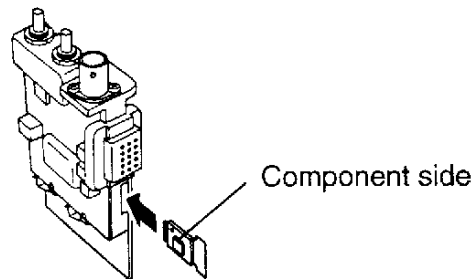

- 7 Fold the plastic cover of the TSU-8 toward the transceiver rear cover.

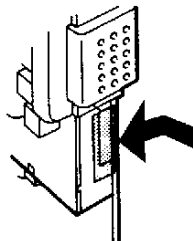

- 8 Replace the inner assembly onto the front cover, then replace the cover for the MIC/ SP/ DC IN jacks.

- First mate the MIC and SP jacks of the inner assembly with the corresponding holes of the front cover.
- If the PTT switch cover came off in step 5, replace the cover so that the notch on the cover faces as shown.

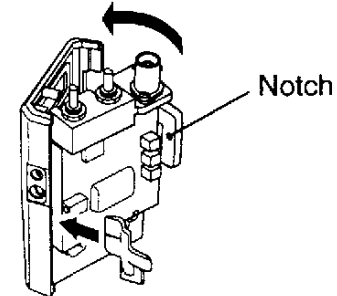

- 9 Replace the inner partition.

- First mate the tabs of the inner partition with the tab holes of the front cover.
- The charging electrodes must be correctly projected out of the holes of the inner partition.

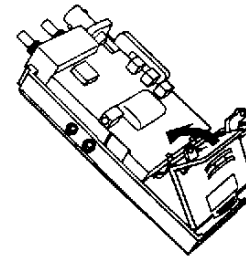

- 10 Replace the rear cover (3 screws).

- 11 Re-install the top rubber cover, the antenna, **VOL** control, and **Tuning** control.

- 12 Re-install the battery pack or battery case.

CONNECTING AN EXTERNAL POWER SOURCE

You can connect the transceiver to a regulated power supply via an optional PG-2W cable, or to the cigarette lighter socket in your vehicle via an optional PG-3J cable.

Note: If input voltage exceeds approximately 18 V, an alarm sounds and "dCErr" appears on the display.

■ Using a Regulated Power Supply

Note:

- ◆ Switch OFF the transceiver and power supply before making any connections.
- ◆ Only use the power supplies recommended by your authorized **KENWOOD** dealer. The supply voltage must be between 7.5 V and 16 V to prevent damaging the transceiver.

- 1 Connect the red lead of the optional PG-2W DC cable to the positive (+) terminal on the power supply. Connect the black lead of this cable to the negative (-) terminal.
- 2 Connect the barrel plug on the DC cable to the DC IN jack on the side of the transceiver.

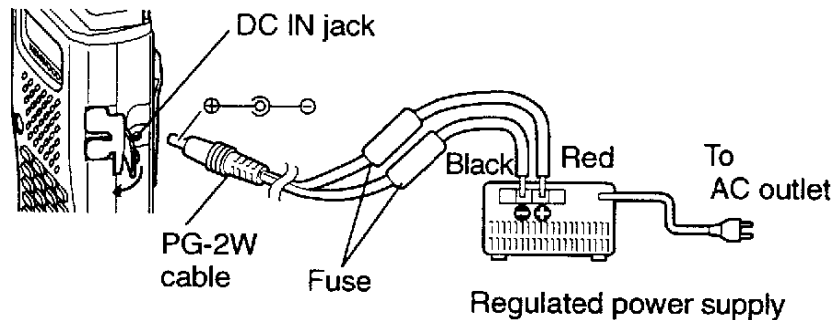

■ Using a Cigarette Lighter Socket

Connect the transceiver to the cigarette lighter socket in your vehicle using the optional PG-3J Cigarette Lighter cable.

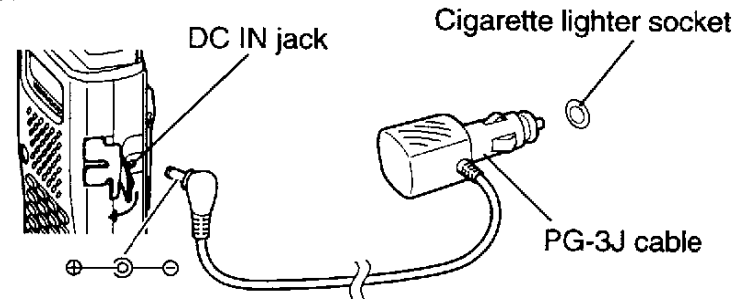

CAUTION: TO CONNECT AN EXTERNAL 24 V POWER SOURCE VIA A DC-DC CONVERTER, ONLY USE THE PG-3J CIGARETTE LIGHTER CABLE. USING THE PG-2W DC CABLE IN THIS SITUATION MAY CAUSE A FIRE.

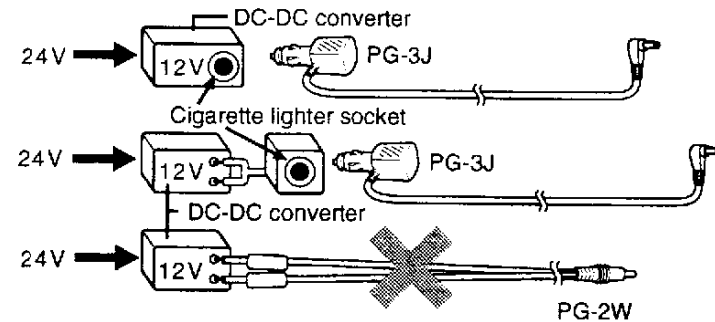

CONNECTING EQUIPMENT FOR REMOTE CONTROL

Make connections as shown when remotely controlling equipment.

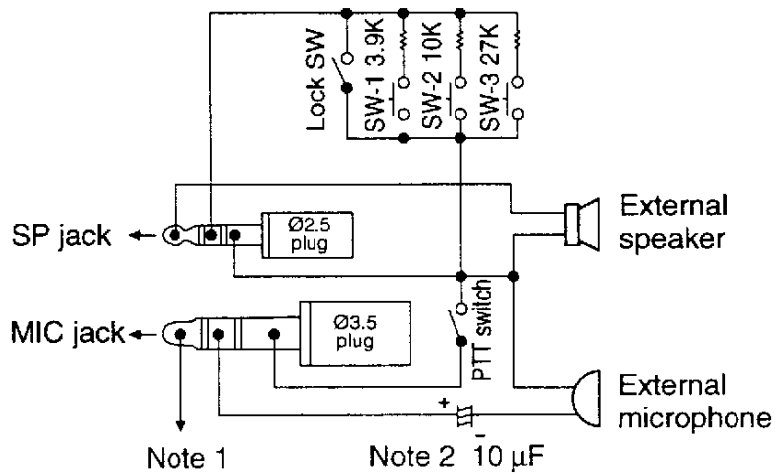

Note 1: Voltage is developed across the $100\ \Omega$ resistor in the 5 V line in the transceiver. When 5 mA flows, approximately 4.5 V is developed.

Note 2: A $10\ \mu\text{F}$ capacitor is not required in the following cases.

- When the other equipment has DC blocking capacitors.
- When a 2-terminal condenser microphone is used.

CONNECTING OTHER EXTERNAL EQUIPMENT

When connecting an external speaker, an external microphone, or other equipment such as a TNC for packet radio to the SP jack or MIC jack, refer to the diagram below.

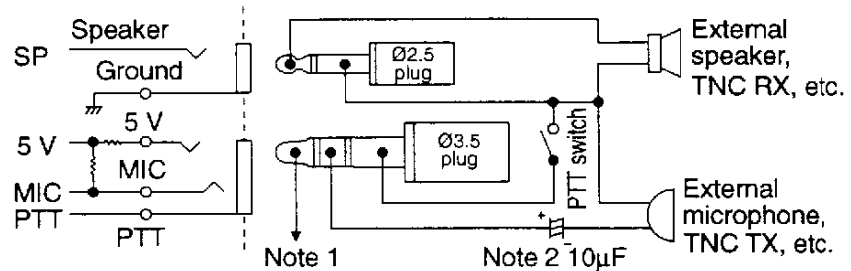

Note 1: Voltage is developed across the $100\ \Omega$ resistor in the 5 V line in the transceiver. When 5 mA flows, approximately 4.5 V is developed.

Note 2: A $10\ \mu\text{F}$ capacitor is not required in the following cases.

- When the other equipment has DC blocking capacitors.
- When a 2-terminal condenser microphone is used.

INSTALLING/REMOVING THE BELT HOOK

The illustrations below show how to install the provided belt hook and how to lock the speaker microphone cable using the belt hook. To remove the belt hook, pull the belt hook downward while pushing its tabs from both sides.

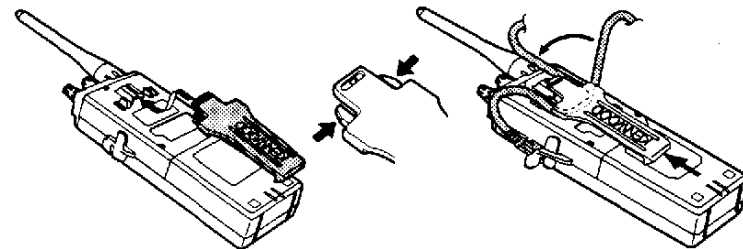

SPECIFICATIONS

General		
Frequency range		136.00 to 173.995
U.S.A./ Canada		144 to 148 MHz
Europe		144 to 146 MHz
General market		144 to 148 MHz
Mode		F3E (FM)
Usable temperature range		-10°C to +50°C (+14°F to +122°F)
Rated Voltage	External power supply (DC IN)	7.5 to 16.0 V (13.8 V)
	Battery terminals	6.8 to 15.0 V (7.2 V)
Current	Receive with no signals	Average 50 mA
	Battery Saver ON	Approx. 14 mA
	Transmit with H, 12.0 V	Approx. 1.3 A
	Transmit with H, 7.2 V	Approx. 0.8 A
	Transmit with L, 7.2 V	Approx. 0.6 A
Grounding method		Negative ground
Dimensions (W x H x D projections included) ¹		62.0 x 166.2 x 37.2 mm 2.44 x 6.54 x 1.47 in
Weight ²		Approx. 361 g (12.7 oz.)
Microphone impedance		2 kΩ
Antenna impedance		50 Ω

¹ With a PB-36 or BT-10 installed

² PB-36 NiCd battery pack, antenna, and belt hook included

Transmitter		
Power output	H, 13.8 V	Approx. 5 W
	H, 12.0 V	Approx. 5 W
	H, 7.2 V	Approx. 1.5 W
	L, 7.2 V	Approx. 1 W
Modulation		Reactance
Maximum frequency deviation		Within ±5 kHz
Spurious emissions		-60 dB or less

Receiver	
Circuitry	Double conversion superhetrodyne
1st intermediate frequency	38.85 MHz
2nd intermediate frequency	450 kHz
Sensitivity (12 dB SINAD)	0.2 μV or less
Squelch sensitivity	0.13 μV or less
Selectivity (-6 dB)	12 kHz or higher
Selectivity (-40 dB)	28 kHz or less
Audio output (10% distortion)	280 mW or higher (8 Ω load)

Specifications are subject to change without notice due to developments in technology.

INDEX

Accessories			
Installing	43		
Optional	42		
Supplied	1		
Automatic Power Off (APO)	33		
Autopatch (U.S.A and Canada)	29		
Battery			
Charging	38		
Installing, Alkaline	3		
Installing, NiCd	2		
Battery Saver	33		
Beep ON/OFF	33		
Busy Channel Lockout	32		
Channel Display Function	21		
Continuous Tone Coded Squelch System (CTCSS)	25		
Dual Tone Multi-Frequency (DTMF) Functions			
Confirming Stored Numbers	30		
Making Calls	29		
Storing Numbers	30		
Tone TX Hold	29		
Transmitting Single Frequency Tones	31		
Transmitting Stored Numbers	31		
Dual Tone Squelch System (DTSS)			
Storing Codes	27		
Using	27		
Frequency, Selecting	9		
Frequency Step Size	35		
Installation			
Cigarette Lighter, Connecting	45		
CTCSS Unit (Option)	43		
Regulated Power Supply, Connecting	45		
Remote control	46		
Keypad Direct Entry			
Frequency	34		
Memory Channel Number	34		
Lamp Function	33		
Lock, Transceiver	32		
Maintenance	37		
Memory Channels			
Clearing	19		
Clone	20		
Direct Number Entry	34		
Initializing	21		
Locking Out	24		
Recalling	19		
Storing, Simplex	17		
Storing, Split	17		
Transfer to VFO	19		
Menu			
Access	10		
Configuration	10		
Microphone Control	36		
Offset			
Automatic Repeater	14		
Offset Direction	12		
Offset Frequency	12		
Power, ON/OFF	8		
Repeater Access	11		
Reset			
Full (Memory)	21		
Partial (VFO)	21		
Reverse Function	15		
Scan			
Carrier-Operated Resume	22		
Memory	24		
Time-Operated Resume	22		
VFO	23		
Specifications	47		
Squelch, Adjusting	8		
Time-Out Timer (TOT)	32		
Tone			
Activating	13		
Selecting	13		
Transmit Power, Selecting	9		
Troubleshooting	40		
TX Inhibit	32		
Volume, Adjusting	8		

KENWOOD