

INSTRUCTION MANUAL

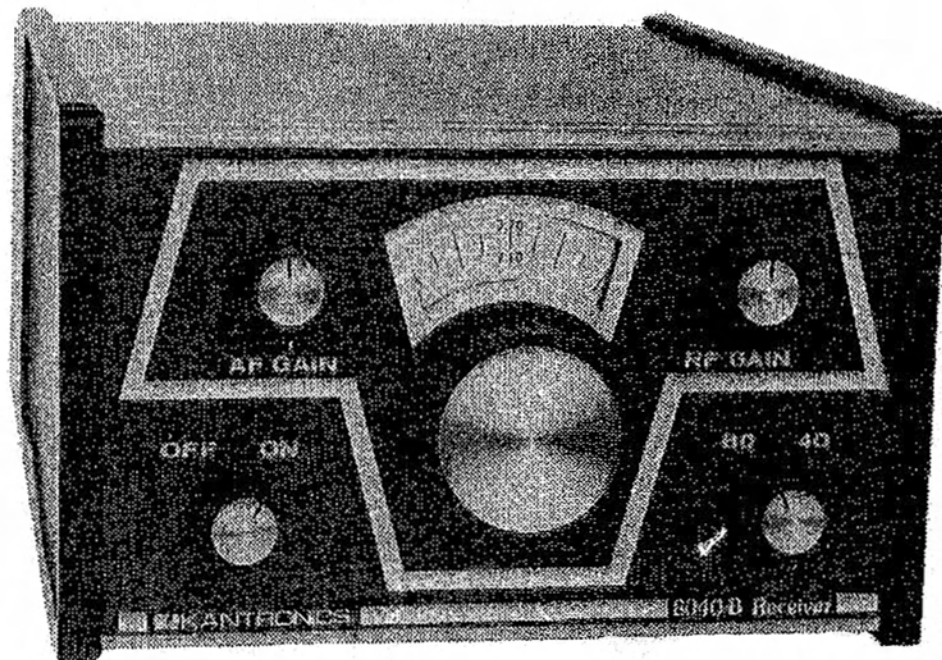

8040-B Receiver

 **KANTRONICS**

1202 East 23rd Street

Lawrence, Kansas 66044

	<u>PAGE</u>
SPECIFICATIONS	2
FUNCTIONS	3, 4
SCHEMATIC DIAGRAM	6, 7
HOW TO USE YOUR 8040-b	
Grounding	
Antenna considerations	
Dial information	
Battery installation	8, 9
TUNING PROCEDURES	10
SERVICE INFORMATION	11
WARRANTY	BACK COVER

**WARNING – Do not attempt to tune HFO
(High Frequency Oscillator) without proper equipment.
HFO is factory calibrated.**

Specifications:

Frequency Coverage

80 meters, 3.65 to 3.75 MHz

40 meters, 7.05 to 7.15 MHz

Power Requirements

Two 9 volt transistor batteries

Size

Approximately HWD 3" x 5" x 7"

Audio Output

**Eight ohm speaker or optional eight ohm
monaural headphones Standard phono
plug**

Sensitivity

One microvolt provides readable signal

Selectivity

1000 Hz @ 6 DB.

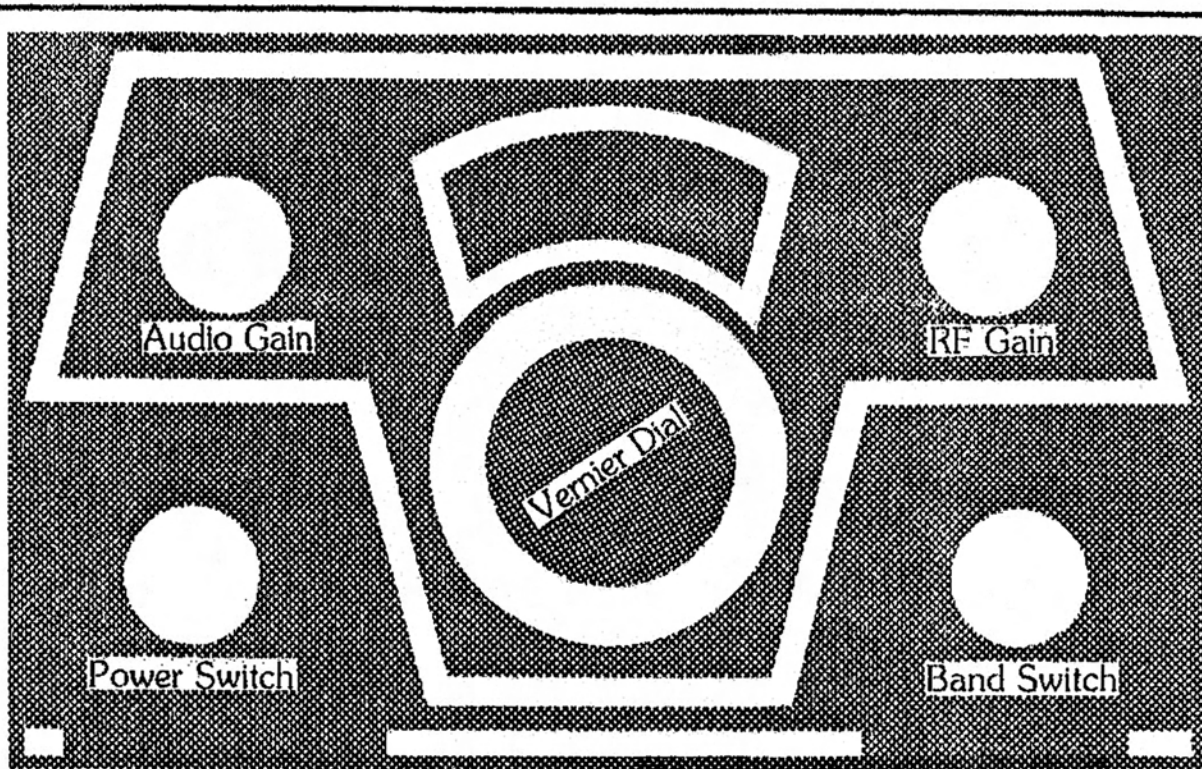

Audio Gain - When rotated clockwise, increases the audio amplification of the receiver. Acts as a volume control.

RF Gain - When rotated clockwise, increases the radio frequency amplification of the receiver. Acts as a volume control.

Power Switch - Receiver is turned on when switch is in the right-hand position.

Vernier Dial - Selects frequency on both bands. Top calibration (in MHz) for 80 meters, and lower calibration (in MHz) for 40 meters. Clockwise rotation decreases frequency. (See page 8.)

Band Switch - Switch selects 80 meters to the left, and 40 meters to the right.



Antenna Jack

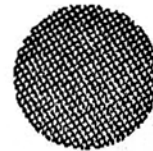

Phono Jack

Antenna Jack - This terminal is used for connecting antenna lead-ins to the receiver. If a dipole antenna is used, solder one lead-in to the RCA connector sleeve, and the remaining lead-in to the connector center. The RCA-type plug is included with the unit.

If a long-wire antenna is used, solder the wire to the center terminal of the RCA plug. Solder an additional wire to the plug sleeve. This wire is used for grounding the 8040-B.

Attach the ground wire to a water pipe, ground rod or station ground system. Your 8040-B will perform best when this ground is used in conjunction with long-wire antennas.

Phono Jack - This terminal is used for connecting an eight ohm speaker or optional monaural headphones to the receiver. Use a standard $\frac{1}{4}$ " phone plug to connect speaker or headphones. (Optional monaural headphone set available from Kantronics with phone plug attached.)

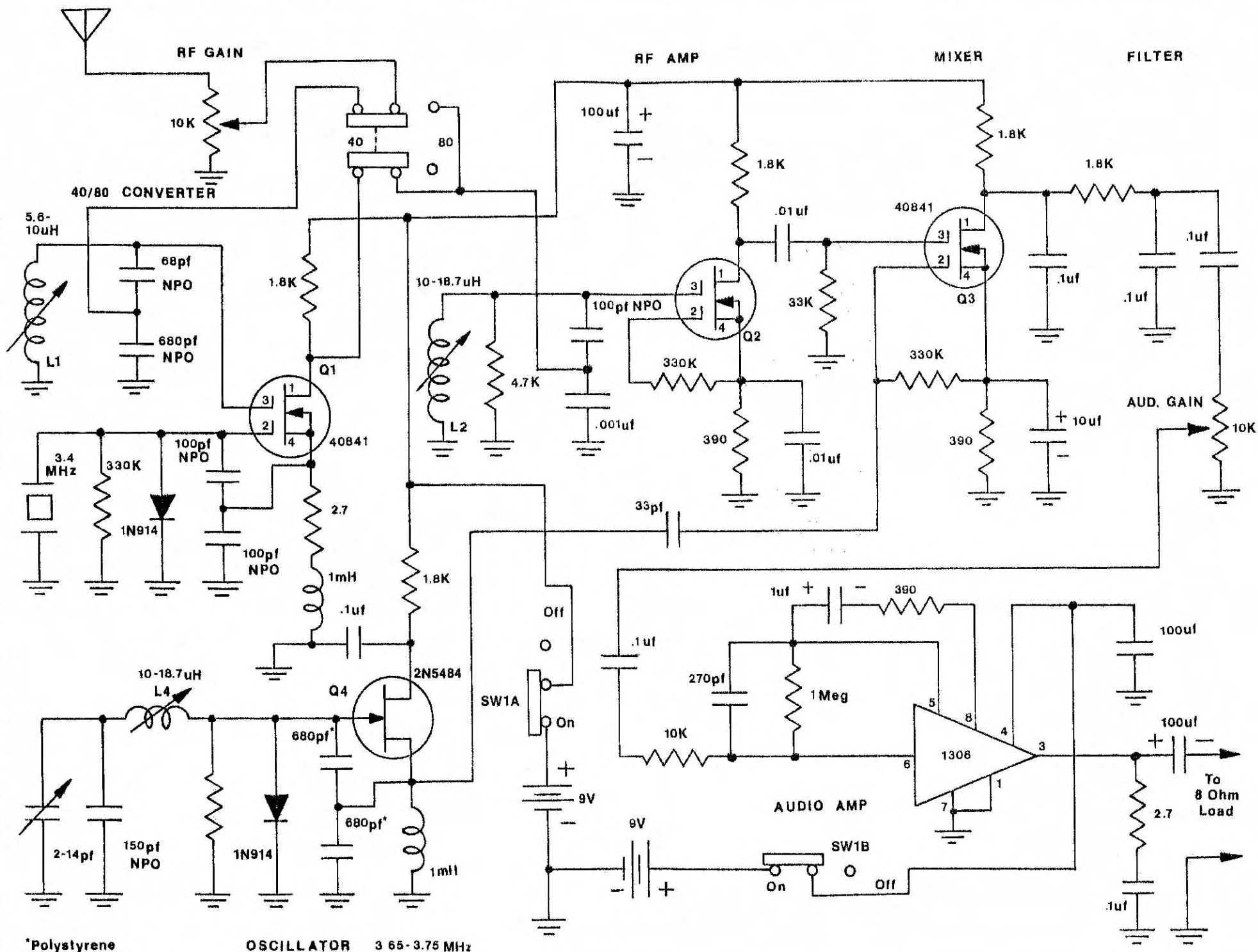

*Polystyrene

OSCILLATOR 3.65-3.75 MHz

To 8 Ohm Load

How To Use Your 8040-B

GROUNDING - In cases where a long-wire antenna is used, the 8040-B will perform better when a good external ground is connected. Solder a wire to the sleeve of the RCA plug, included with the unit. Connect the other end to a good ground source such as a water pipe, copper ground rod driven into the earth or the existing station ground system, if available. When the RCA plug is attached, the receiver will then be adequately grounded.

ANTENNA - The 8040-B will operate by simply connecting a long-wire to the antenna jack of the rear panel. A length of 65 feet or greater is recommended. Highly improved results, however, can be achieved with the use of a dipole antenna as diagrammed below:

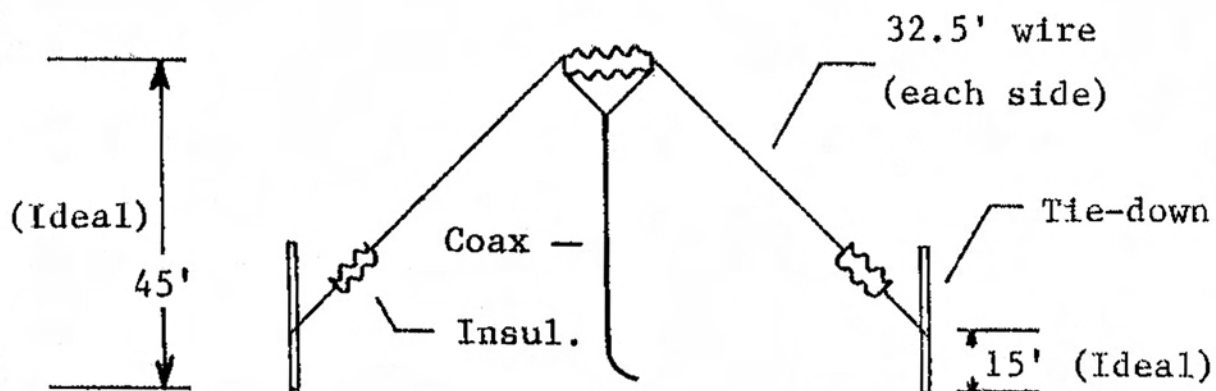

DIAL INFORMATION - Tuning in stations with a vernier dial is fast and simple. The vernier dial turns almost seven times for each rotation of the tuning capacitor. This means that stations are tuned by more slowly, making them easier to locate. Signal frequency decreases as the dial is rotated clockwise. The coverage of the 8040-B is diagrammed on the following page:

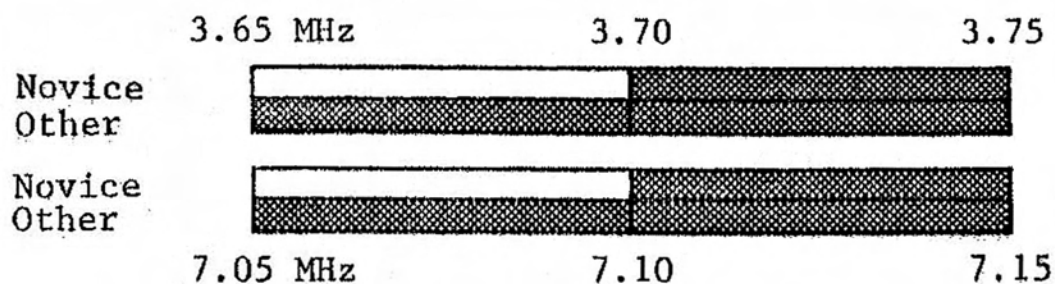

USING THE RF GAIN - Many times, signals on the air are situated so closely that it is difficult to separate them in order to copy. By using the RF Gain and AF Gain controls in conjunction, signal interference can be reduced. Once a station has been selected, adjust the RF Gain to minimize interference from surrounding stations. Then adjust the Audio Gain to the desired listening level. By using these two controls in conjunction, the desired station can be amplified to higher levels than surrounding interference.

Battery Installation

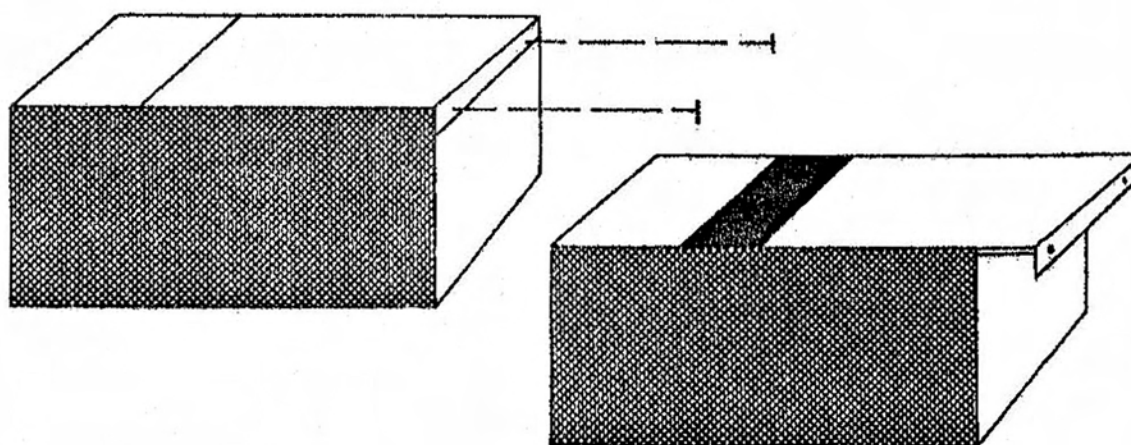

The 8040-B will operate from two 9 volt transistor batteries. To install a fresh pair of batteries, remove screws in back of the unit which secure the top panel. Slide the panel out, locating battery clips, and install batteries.

Be sure good connections are made with both batteries. Replace batteries when necessary, and remove them during periods of storage.

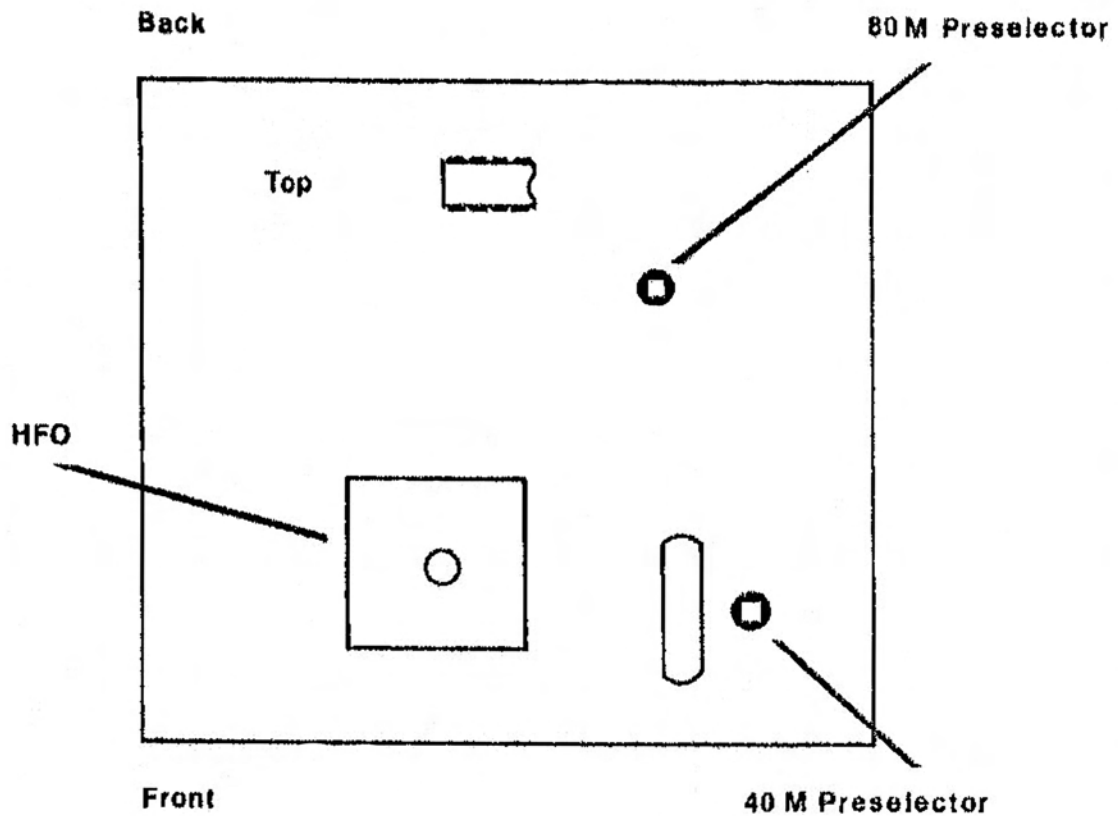

8040-B PC board representation.

WARNING! - Do not attempt to tune HFO (High Frequency Oscillator) without proper equipment.
HFO is factory calibrated.

TUNING PROCEDURES - The preselector coils may be peaked with the plastic adjustment tool included with the unit. These preselectors help match the 8040-B with varying antenna impedances. To peak reception for a particular antenna, simply rotate the proper choke for maximum signal strength. Once set, the preselectors should be peaked as long as the same antenna is used.

FOR SERVICE INFORMATION OR REPAIRS:

Write to:

KANTRONICS, INCORPORATED

ATTN: Service Department AR

1202 East 23rd Street

Lawrence, Kansas 66044

FOR REPAIRS, PLEASE PHONE BEFORE RETURNING

(913) 842-7745

FOR FURTHER INFORMATION ON AMATEUR RADIO, WE SUGGEST YOU WRITE:

The American Radio Relay League

225 Main Street

Newington, Connecticut 06111

RL/RB: 5:78:3