

PTF 10122

50 Watts WCDMA, 2.1–2.2 GHz

GOLDMOS™ Field Effect Transistor

Description

The PTF 10122 is an internally matched common source N-channel enhancement-mode lateral MOSFET intended for WCDMA applications from 2.1 to 2.2 GHz. It is rated at 50 watts power output, with 11 dB of gain. Nitride surface passivation and full gold metallization ensure excellent device lifetime and reliability.

- **INTERNALLY MATCHED**
- **Guaranteed Performance at 2.17 GHz, 28 V**
 - Output Power = 50 Watts Min
 - Gain = 11.0 dB Typ
 - Efficiency = 35% Typ
- **Full Gold Metallization**
- **Silicon Nitride Passivated**
- **Back Side Common Source**
- **Excellent Thermal Stability**
- **100% Lot Traceability**

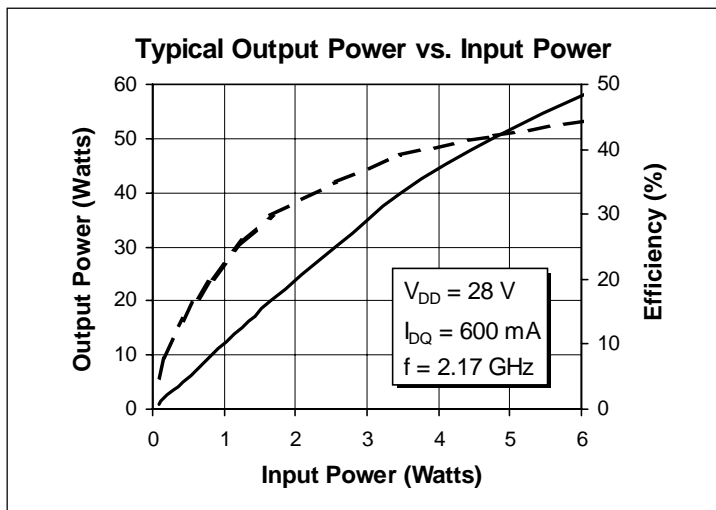

Package 20248

RF Specifications (100% Tested)

Characteristic	Symbol	Min	Typ	Max	Units
Gain ($V_{DD} = 28\text{ V}$, $P_{OUT} = 15\text{ W}$, $I_{DQ} = 600\text{ mA}$, $f = 2.11\text{ GHz}$)	G_{ps}	10.0	11.0	—	dB
Power Output at 1 dB Compression ($V_{DD} = 28\text{ V}$, $I_{DQ} = 600\text{ mA}$, $f = 2.17\text{ GHz}$)	P-1dB	50	—	—	Watts
Drain Efficiency ($V_{DD} = 28\text{ V}$, $P_{OUT} = 50\text{ W}$, $I_{DQ} = 600\text{ mA}$, $f = 2.17\text{ GHz}$)	η_D	30	35	—	%
Load Mismatch Tolerance ($V_{DD} = 28\text{ V}$, $P_{OUT} = 50\text{ W}$, $I_{DQ} = 600\text{ mA}$, $f = 2.17\text{ GHz}$ —all phase angles at frequency of test)	Ψ	—	—	10:1	—

All published data at $T_{CASE} = 25^\circ\text{C}$ unless otherwise indicated.

Electrical Characteristics (100% Tested)

Characteristic	Conditions	Symbol	Min	Typ	Max	Units
Drain-Source Breakdown Voltage	$V_{GS} = 0\text{ V}, I_D = 100\text{ mA}$	$V_{(BR)DSS}$	65	—	—	Volts
Zero Gate Voltage Drain Current	$V_{DS} = 28\text{ V}, V_{GS} = 0\text{ V}$	I_{DSS}	—	—	2.0	mA
Gate Threshold Voltage	$V_{DS} = 10\text{ V}, I_D = 150\text{ mA}$	$V_{GS(th)}$	3.0	—	5.0	Volts
Forward Transconductance	$V_{DS} = 10\text{ V}, I_D = 2\text{ A}$	g_{fs}	—	4.0	—	Siemens

Maximum Ratings

Parameter	Symbol	Value	Unit
Drain-Source Voltage	V_{DSS}	65	Vdc
Gate-Source Voltage	V_{GS}	± 20	Vdc
Operating Junction Temperature	T_J	200	$^{\circ}\text{C}$
Total Device Dissipation Above 25°C derate by	P_D	237 1.35	Watts $\text{W}/^{\circ}\text{C}$
Storage Temperature Range	T_{STG}	-40 to $+150$	$^{\circ}\text{C}$
Thermal Resistance ($T_{CASE} = 70^{\circ}\text{C}$)	$R_{\theta JC}$	0.74	$^{\circ}\text{C}/\text{W}$

Typical Performance

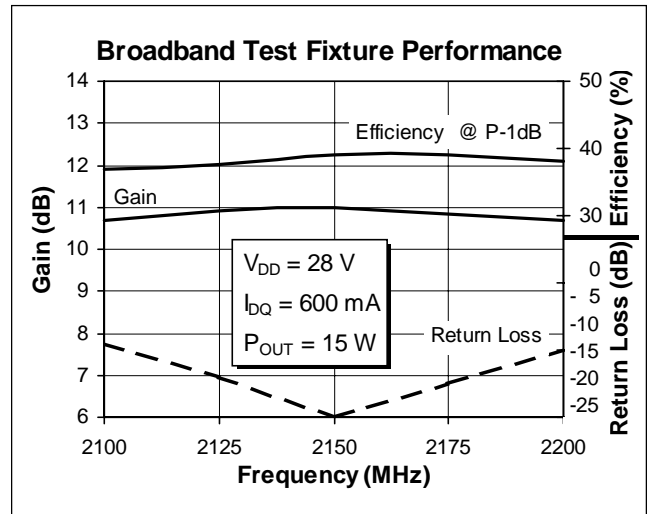
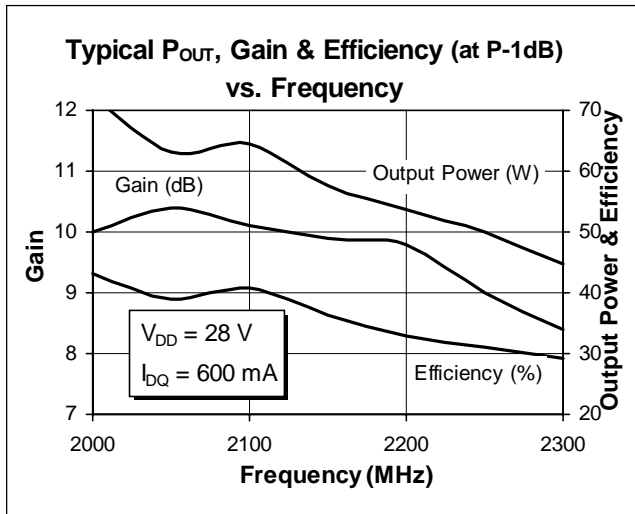

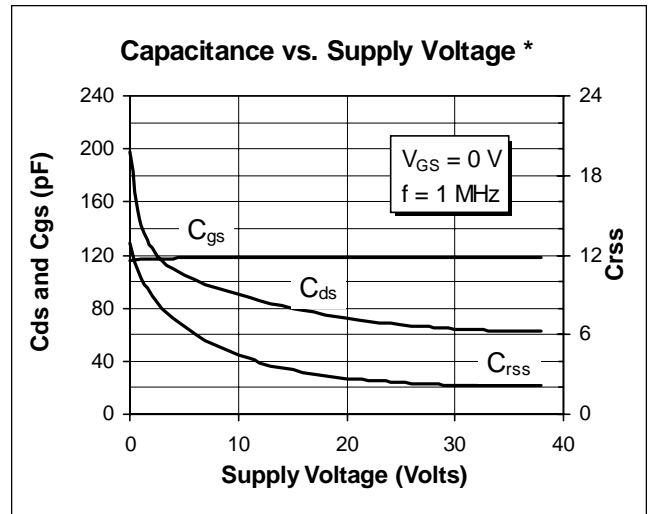
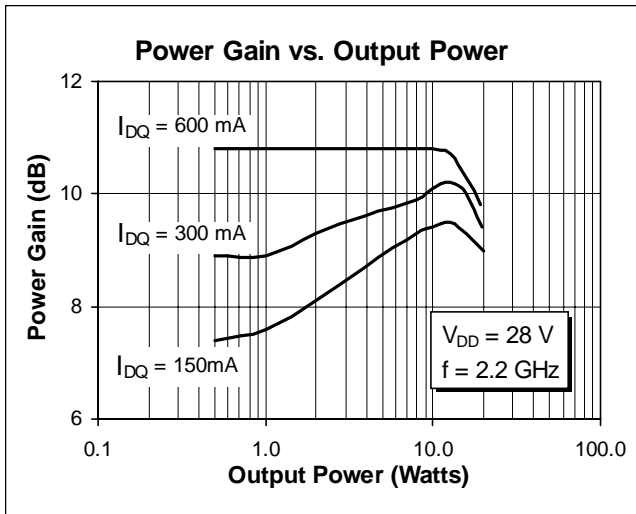
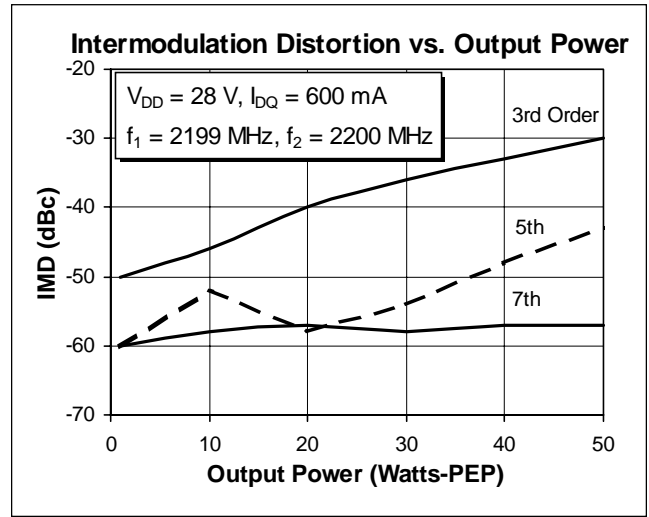
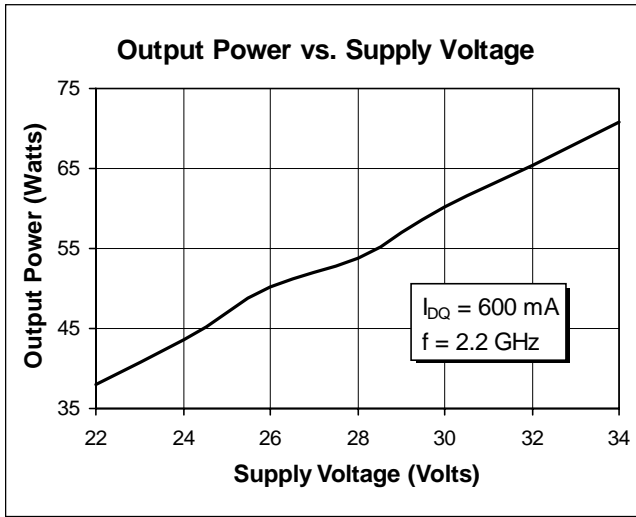

* This part is internally matched. Measurements of the finished product will not yield these results.

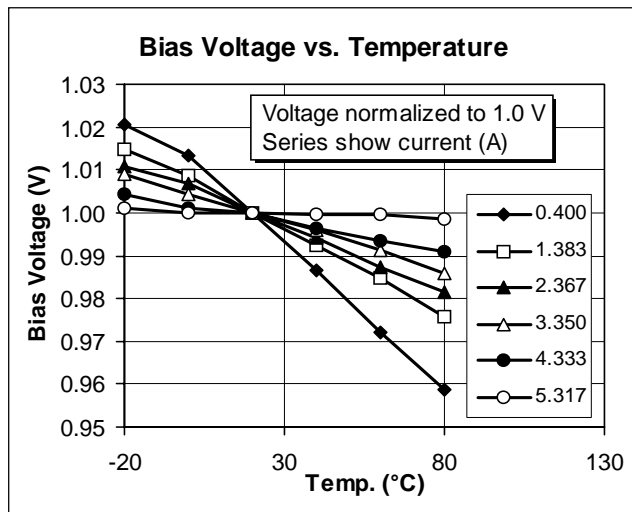

Impedance Data

$V_{DD} = 28\text{ V}$, $P_{OUT} = 50\text{ W}$, $I_{DQ} = 600\text{ mA}$

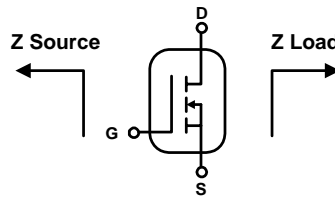

Frequency GHz	Z Source Ω		Z Load Ω	
	R	jX	R	jX
2.00	2.88	-7.20	1.05	-0.90
2.05	3.70	-7.80	1.30	-1.30
2.10	4.80	-8.80	1.50	-1.50
2.15	8.00	-8.90	1.40	-1.90
2.20	9.50	-7.30	1.30	-2.00
2.25	11.00	-3.00	1.22	-1.70
2.30	10.00	-0.60	1.30	-1.40

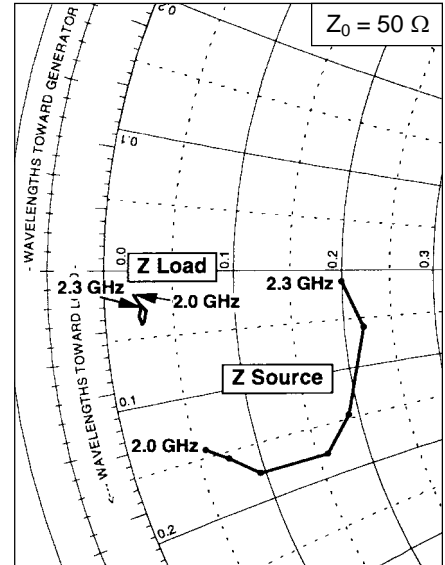

Test Circuit

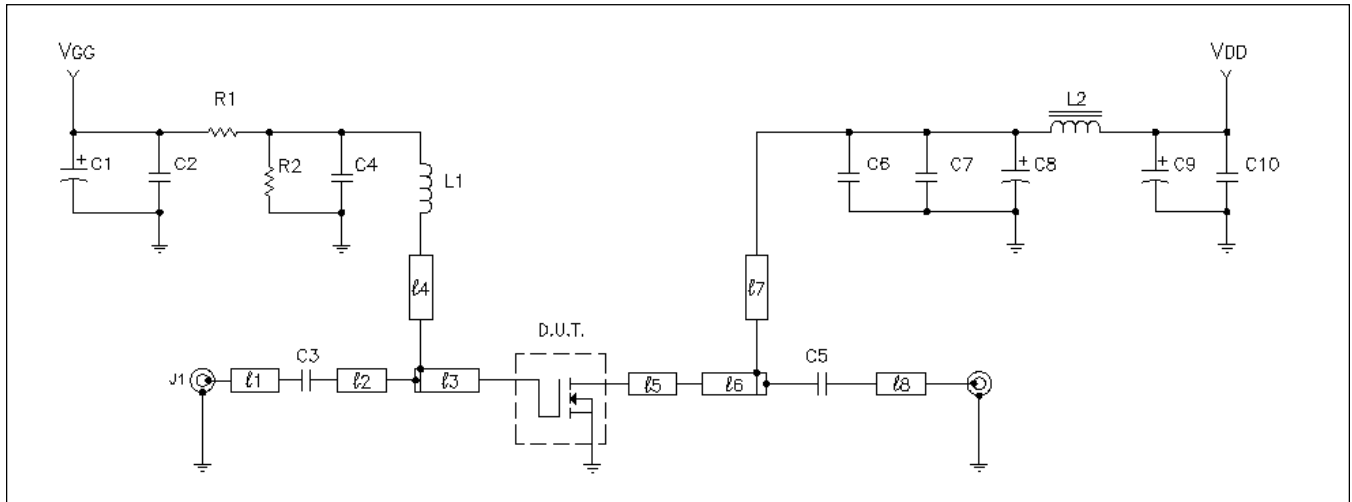

Test Circuit Block Diagram for $f = 2.1\text{--}2.2\text{ GHz}$

Q1	PTF 10122	LDMOS RF Transistor	C2, C10	0.1 μF Chip Cap	ATC 100 B
ℓ_1	.240 λ @ 2.15 GHz	Microstrip 50 Ω	C3, C4, C5, C6	10 pF Chip Cap	ATC 100 B
ℓ_2	.0281 λ @ 2.15 GHz	Microstrip 14.7 Ω	C7	0.1 μF , 50 V	Digi-Key Capacitor 2.2 QBK
ℓ_3	.085 λ @ 2.15 GHz	Microstrip 9.5 Ω	C8	100 μF , 50 V	Digi-Key Capacitor
ℓ_4	.104 λ @ 2.15 GHz	Microstrip 78 Ω	L1	2.7 nH	Chip Inductor
ℓ_5	.120 λ @ 2.15 GHz	Microstrip 6.82 Ω	L2	6mm	SMT Ferrite Bead
ℓ_6	.063 λ @ 2.15 GHz	Microstrip 10.88 Ω	R1, R2	220 Ω Chip Resistor	Digi-Key 2.2 QBK
ℓ_7	.216 λ @ 2.15 GHz	Microstrip 65 Ω	Circuit Board	Dielectric Thickness = 0.050", $\epsilon_r = 6.0$ @ 1 MHz, 2 oz. Copper, TMM6,	
ℓ_8	.174 λ @ 2.15 GHz	Microstrip 50 Ω			
C1, C9	10 μF Chip Cap	ATC 100 B		Rogers	

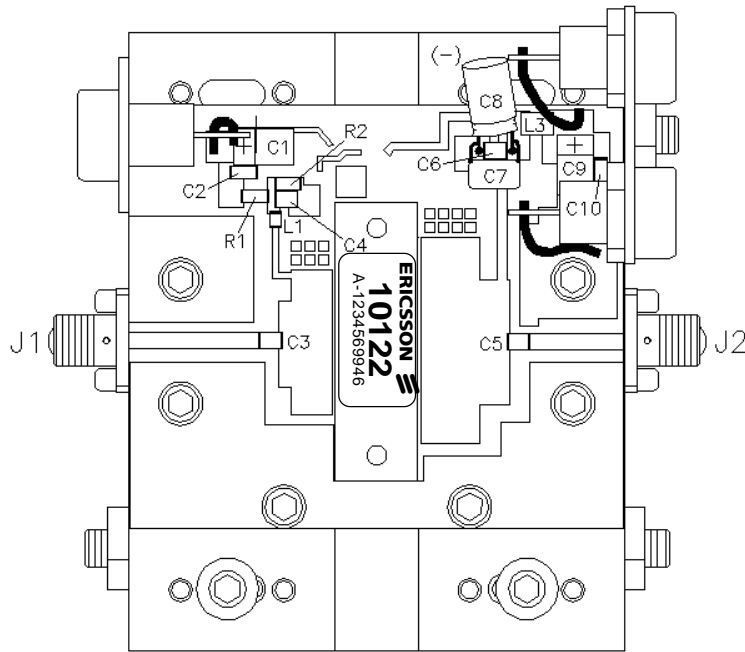

Parts Layout (not to scale)

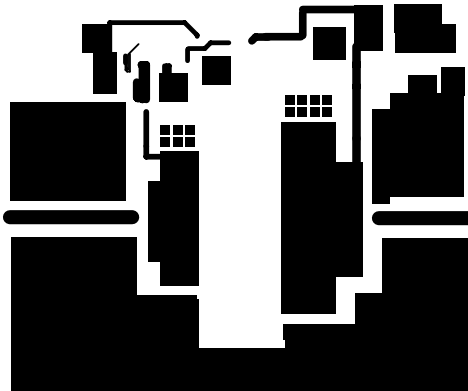

Artwork (not to scale)

Package Mechanical Specifications

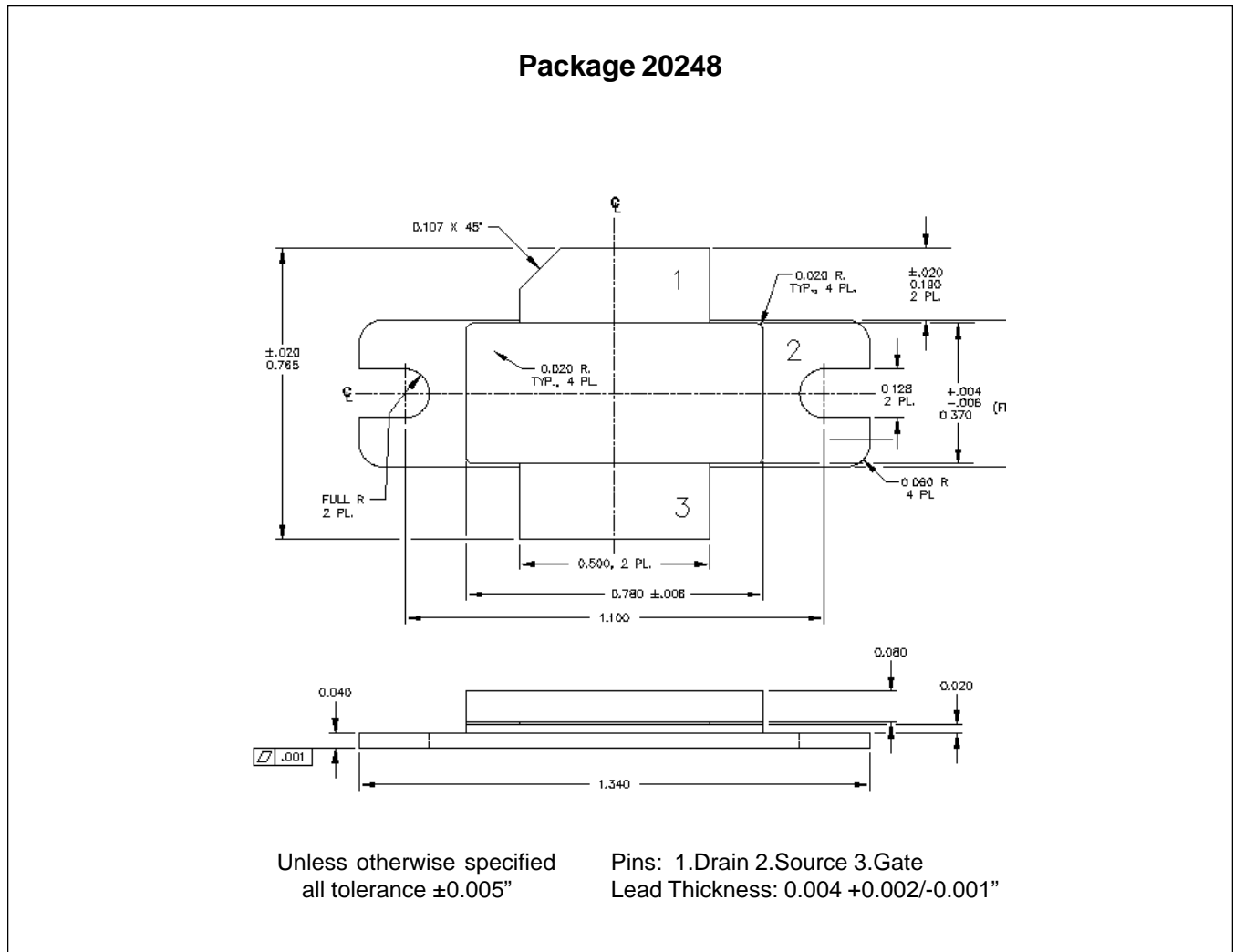

This datasheet has been download from:

www.datasheetcatalog.com

Datasheets for electronics components.