

2N5944
2N5945
2N5946

The RF Line

NPN SILICON RF POWER TRANSISTORS

... designed for 7.0 to 15 Volts, UHF large signal amplifier applications required in industrial and commercial FM equipment operating in the 400 to 960 MHz range.

- Specified 12.5 Volt, 470 MHz Characteristics -
 - Power Output = 2.0 W 2N5944
 - 4.0 W 2N5945
 - 10 W 2N5946
- Minimum Gain = 9.0 dB - 2N5944
- 8.0 dB 2N5945
- 6.0 dB 2N5946
- Efficiency = 60% Minimum
- Characterized with series equivalent large signal impedance parameters

2.0, 4.0, 10 W - 470 MHz
RF POWER
TRANSISTORS
NPN SILICON

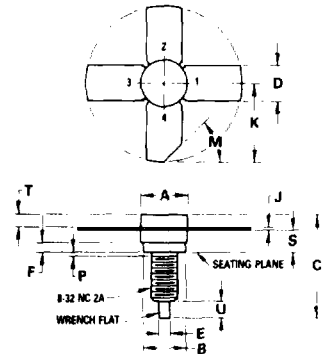
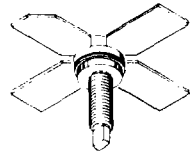

MAXIMUM RATINGS

Rating	Symbol	2N5944	2N5945	2N5946	Unit
*Collector-Emitter Voltage	V _{CEO}	16			Vdc
*Collector-Base Voltage	V _{CBO}	36			Vdc
*Emitter-Base Voltage	V _{EBO}	4.0			Vdc
*Collector Current - Continuous	I _C	0.4	0.8	2.0	Adc
*Total Device Dissipation @ T _C = 25°C ⁽¹⁾ Derate above 25°C	P _D	5.0 28.5	15 85.5	37.5 214	Watts mW/°C
*Storage Temperature Range	T _{stg}	-65 to +200			°C
Stud Torque ⁽²⁾		6.5			in-lbs.

*Indicates JEDEC Registered Data
 (1) These devices are designed for RF operation. The total device dissipation rating applies only when the devices are operated as RF amplifiers.
 (2) For repeated assembly use 5 in lbs.

DIM	MILLIMETERS		INCHES	
	MIN	MAX	MIN	MAX
A	7.06	7.26	0.278	0.286
B	6.20	6.50	0.244	0.256
C	14.99	16.51	0.590	0.650
D	5.46	5.96	0.215	0.235
E	1.40	1.65	0.055	0.065
F	1.52	—	0.060	—
J	0.08	0.17	0.003	0.007
K	11.05	—	0.435	—
M	45° NOM		45° NOM	
P	—	1.27	—	0.050
S	3.90	3.25	0.118	0.128
T	1.40	1.77	0.055	0.070
U	2.92	3.68	0.115	0.145

STYLE 1:
 PIN 1: EMITTER
 2: BASE
 3: EMITTER
 4: COLLECTOR

CASE 244-04

2N5944, 2N5945, 2N5946

*ELECTRICAL CHARACTERISTICS (T_C = 25°C unless otherwise noted)

Characteristic	Symbol	Min	Typ	Max	Unit
OFF CHARACTERISTICS					
Collector-Emitter Breakdown Voltage (I _C = 50 mA, I _B = 0)	V _{(BR)CEO}	16	-	-	Vdc
(I _C = 100 mA, I _B = 0)		16	-	-	
(I _C = 200 mA, I _B = 0)		16	-	-	
Collector-Emitter Breakdown Voltage (I _C = 50 mA, V _{BE} = 0)	V _{(BR)CES}	36	-	-	Vdc
(I _C = 100 mA, V _{BE} = 0)		36	-	-	
(I _C = 200 mA, V _{BE} = 0)		36	-	-	
Emitter-Base Breakdown Voltage (I _E = 1.0 mA, I _C = 0)	V _{(BR)EBO}	4.0	-	-	Vdc
(I _E = 2.0 mA, I _C = 0)		4.0	-	-	
(I _E = 4.0 mA, I _C = 0)		4.0	-	-	
Collector Cutoff Current (V _{CE} = 15 Vdc, V _{BE} = 0, T _C = 55°C)	I _{CE} S	-	0.2	10	mA
		-	0.5	20	
Collector Cutoff Current (V _{CB} = 15 Vdc, I _E = 0)	I _C BO	-	-	1.0 2.0	mA
ON CHARACTERISTICS					
DC Current Gain (I _C = 100 mA, V _{CE} = 5.0 Vdc)	h _{FE}	20	80	-	-
(I _C = 200 mA, V _{CE} = 5.0 Vdc)		20	80	-	
(I _C = 500 mA, V _{CE} = 5.0 Vdc)		20	80	-	
DYNAMIC CHARACTERISTICS					
Output Capacitance (V _{CB} = 12.5 Vdc, I _E = 0, f = 1.0 MHz)	C _{ob}	-	11 18 38	15 25 45	pF
FUNCTIONAL TEST (Figures 20 and 21)					
Common-Emitter Amplifier Power Gain (V _{CC} = 12.5 Vdc, P _{out} = 2.0 W, I _{C(max)} = 267 mA, f = 470 MHz)	G _{PE}	9.0	10	-	dB
(V _{CC} = 12.5 Vdc, P _{out} = 4.0 W, I _{C(max)} = 533 mA, f = 470 MHz)		8.0	9.0	-	
(V _{CC} = 12.5 Vdc, P _{out} = 10 W, I _{C(max)} = 1.33 A, f = 470 MHz)		6.0	7.0	-	
Collector Efficiency (V _{CC} = 12.5 Vdc, P _{out} = 2.0 W, I _{C(max)} = 240 mA, f = 470 MHz)	η	60	-	-	%
(V _{CC} = 12.5 Vdc, P _{out} = 4.0 W, I _{C(max)} = 500 mA, f = 470 MHz)		60	-	-	
(V _{CC} = 12.5 Vdc, P _{out} = 10 W, I _{C(max)} = 1.3 A, f = 470 MHz)		60	-	-	

* Indicates JEDEC Registered Data

These devices are available in various packages, such as a studless stripline package, TO-205AD (TO-39) and also in chip form on beryllium oxide carriers for hybrid assemblies.

For further information, contact your nearest Motorola representative or the factory representative.

2N5944, 2N5945, 2N5946

2N5944 TYPICAL PERFORMANCE DATA

FIGURE 1 – SERIES EQUIVALENT IMPEDANCE

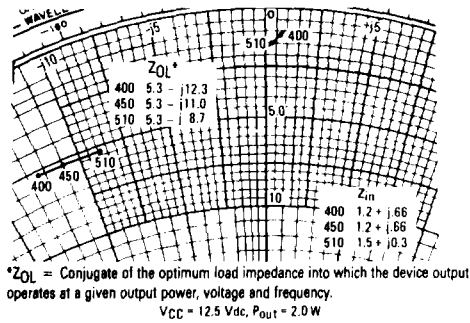

FIGURE 2 – OUTPUT POWER versus SUPPLY VOLTAGE

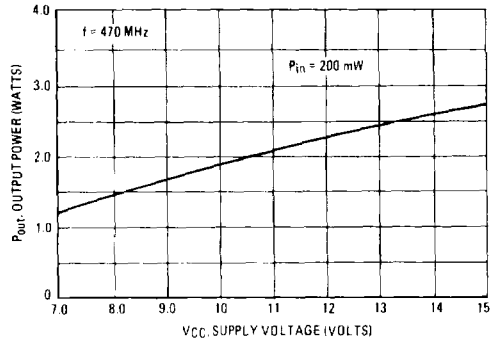

FIGURE 3 – OUTPUT POWER versus INPUT POWER

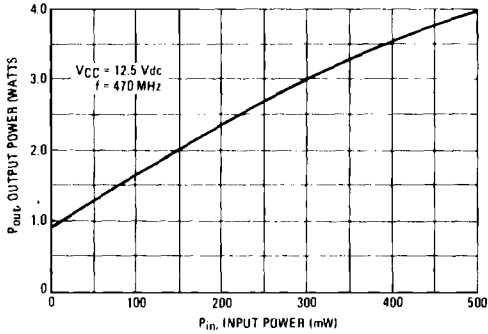

FIGURE 4 – OUTPUT POWER versus FREQUENCY

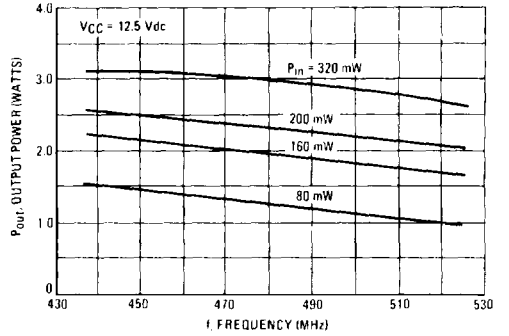

FIGURE 5 – OUTPUT POWER versus INPUT POWER

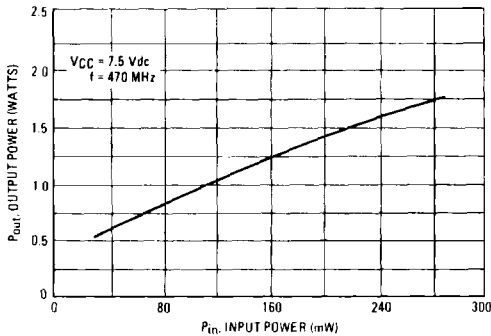
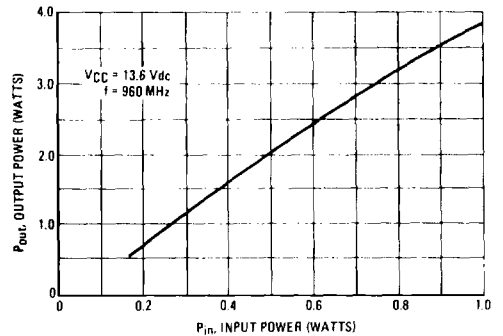

FIGURE 6 – OUTPUT POWER versus INPUT POWER



2N5944, 2N5945, 2N5946

2N5945 TYPICAL PERFORMANCE DATA

FIGURE 7 - SERIES EQUIVALENT IMPEDANCE

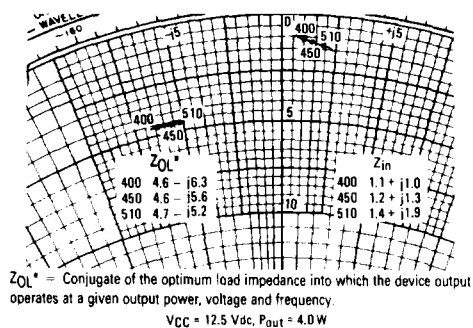

FIGURE 8 - OUTPUT POWER versus SUPPLY VOLTAGE

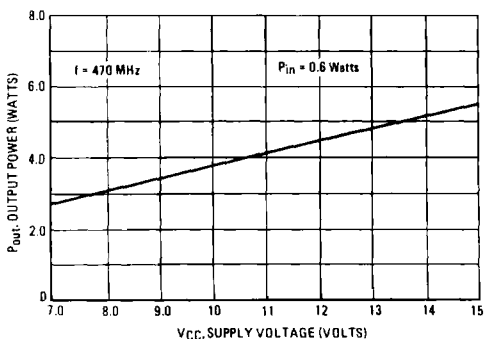

FIGURE 9 - OUTPUT POWER versus INPUT POWER

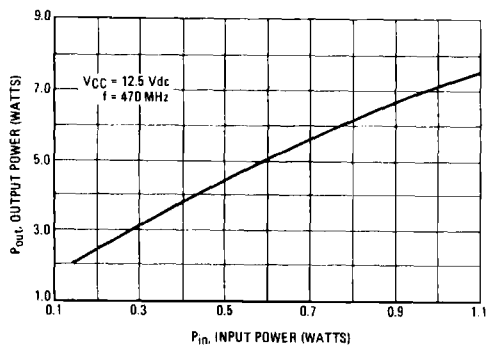

FIGURE 10 - OUTPUT POWER versus FREQUENCY

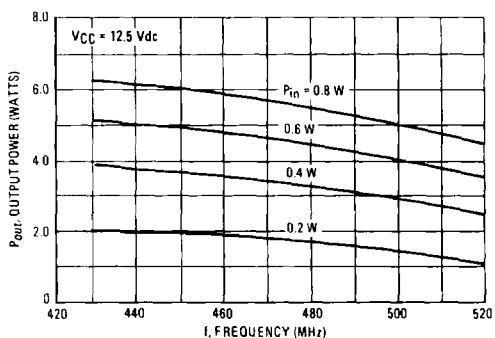

FIGURE 11 - OUTPUT POWER versus INPUT POWER

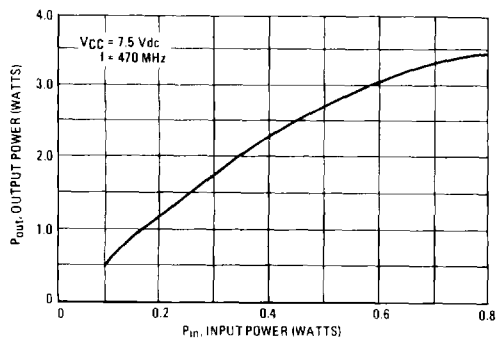
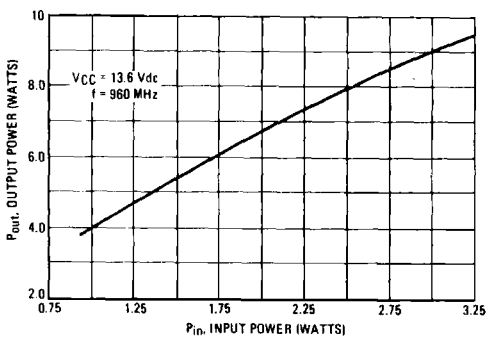

FIGURE 12 - OUTPUT POWER versus INPUT POWER



2N5944, 2N5945, 2N5946

2N5946 TYPICAL PERFORMANCE DATA

FIGURE 13 – SERIES EQUIVALENT IMPEDANCE

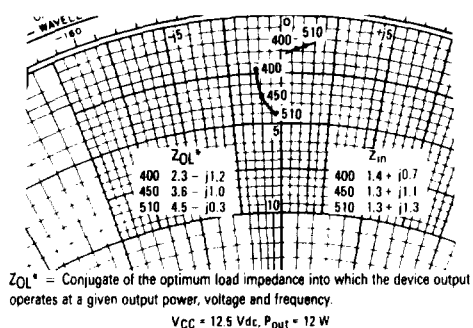

FIGURE 14 – OUTPUT POWER versus SUPPLY VOLTAGE

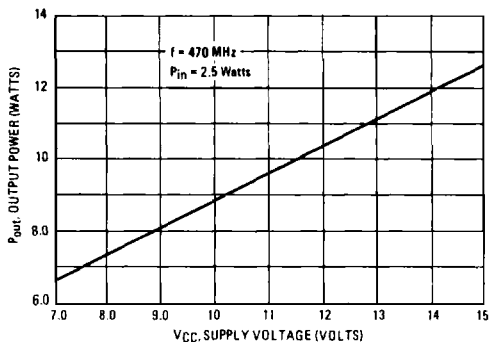

FIGURE 15 – OUTPUT POWER versus INPUT POWER

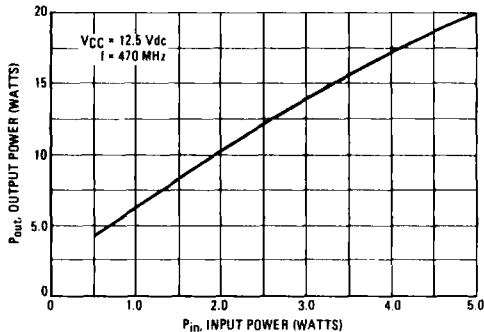

FIGURE 16 – OUTPUT POWER versus FREQUENCY

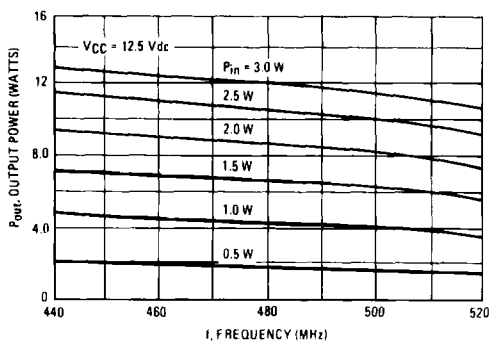
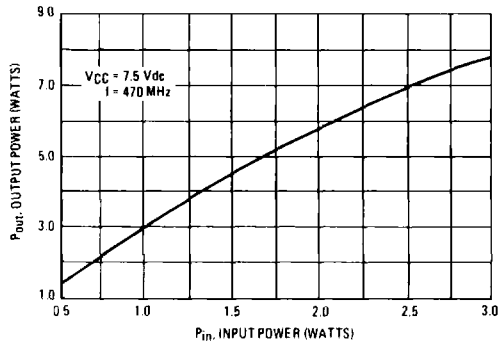
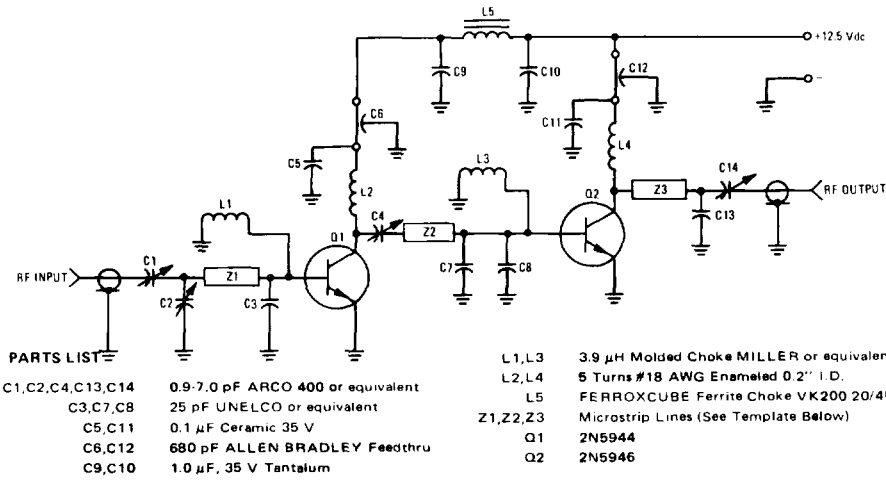

FIGURE 17 – OUTPUT POWER versus INPUT POWER



2N5944, 2N5945, 2N5946

FIGURE 18 — 10-WATT BROADBAND UHF AMPLIFIER



10 W AMPLIFIER PERFORMANCE

$V_{CC} = 12.5 \text{ Vdc}$

Frequency MHz	P_{in} mW	P_{out} W	I_C Amp
440	250	8.5	1.5
450	250	11	1.6
460	250	12	1.6
470	250	10.9	1.5
480	250	8.2	1.2

FIGURE 19 — OUTPUT POWER versus FREQUENCY

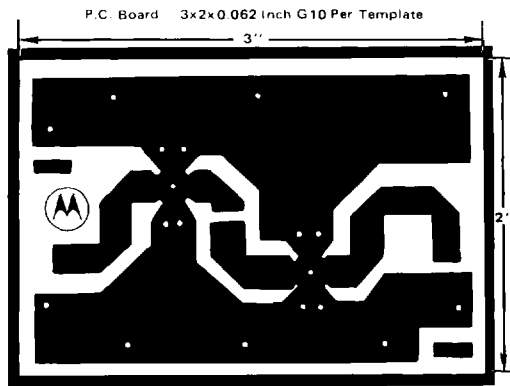
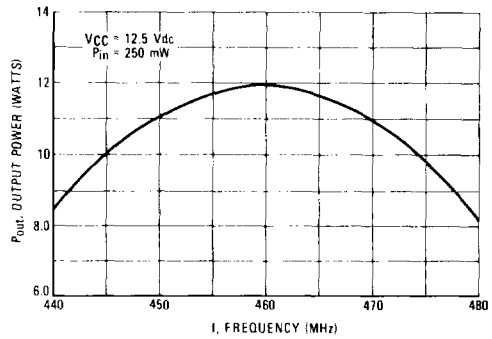

FIGURE 20 — PC BOARD PHOTOMASTER — 10 WATT BROADBAND AMPLIFIER

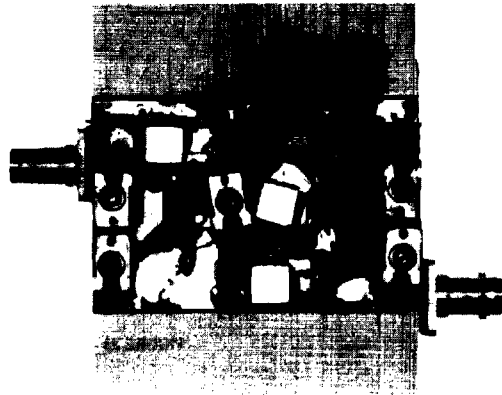
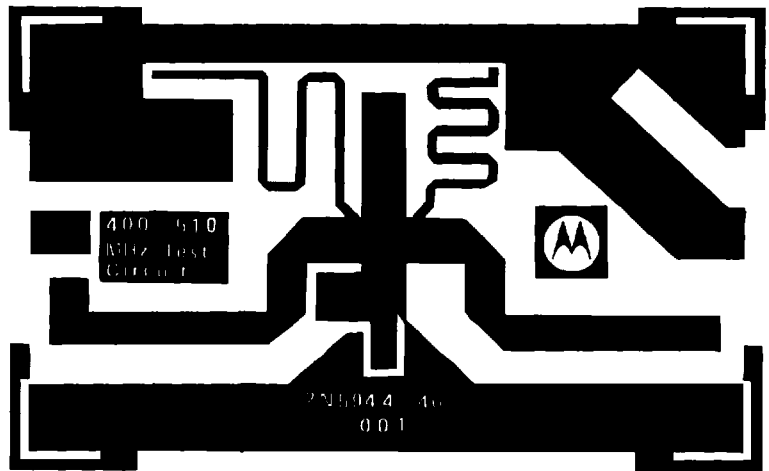

FIGURE 21 — PHOTO OF 10 WATT BROADBAND AMPLIFIER

2



NOTE: The Printed Circuit Board shown is 75% of the original.

FIGURE 22 — 470 MHz TEST CIRCUIT

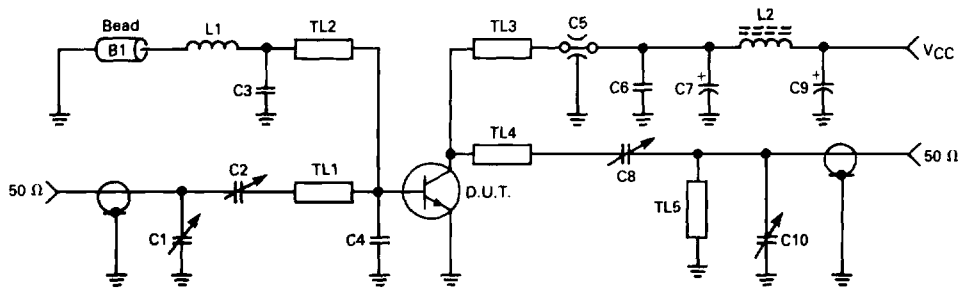

- C1, C2, C8, C10 — Johanson Trimmer, JMC #5501
- C3 — 100 pF Unelco 350 Vdc J101
- C4 — 15 pF Unelco
- C5 — 680 pF Allen Bradley Feed-Thru
- C6 — 0.1 μ F Monolithic
- C7 — 1 μ F Tantalum Sprague \pm 10% 35 Vdc
- C9 — 5 μ F Electrolytic 5-25 Vdc

- TL1 — Micro Strip 0.26" x 2.9"
- TL2 — Micro Strip 0.055" x 3.9"
- TL3 — Micro Strip 0.055" x 2.9"
- TL4 — Micro Strip 0.26" x 2.9"
- TL5 — Micro Strip 0.50" x 1.2"
- L1 — #18 AWG Wire 0.750" Long
- L2 — VK200 20/4B
- B1 — Ferroxcube Bead, 56-590-65-3B

Board — 0.062" Glass Teflon
2 oz. Cu CLAD
 $\epsilon_r = 2.55$

FIGURE 23 — 470 MHz TEST CIRCUIT SCHEMATIC