



HR2600

10 Meter Amateur
Mobile Transceiver

Contents

Welcome!	2
Unpacking.....	2
Controls and Functions	3-5
Front Panel Connector.....	6
CTCSS Control	7
Setting & Using CTCSS.....	7
Switch Settings for S301.....	8
Rear Panel Connectors	9
Power Connector	9
Antenna Connector	10
Installation.....	11
Transceiver Mounting	11
Mobile Antenna.....	11
Ground Information.....	11
Power Cord Connection.....	11
Operation.....	12
Selecting a frequency	12
VFO Operation.....	12
Repeater Operation	12
USB/LSB/AM/FM Operation	12
Noise Blanker.....	12
F. Lock	12
CW Operation	13
Receive Scanning.....	13
Scanning Operation	13
Multifunction Meter.....	14
S/RF Meter.....	14
MOD Meter	14
SWR CAL Meter	14
SWR Meter	15
Specifications	16
General	16
Transmitter.....	16
Receiver.....	16
Troubleshooting	17
Amateur Radio Operation.....	18-19
Warranty.....	20

One Year Limited Warranty

WARRANTOR: UNIDEN CORPORATION OF AMERICA ("UNIDEN".)

ELEMENTS OF WARRANTY: UNIDEN warrants, for the duration of this warranty, UNIDEN CB Product (hereinafter referred to as the Product) to be free from defects in materials and craftsmanship with only the limitations or exclusions set out below.

WARRANTY DURATION: This warranty shall terminate and be of no further effect one (1) year after the date of the original purchase of the Product or at the time the Product is (A) damaged or not maintained as reasonable or necessary, (B) modified, (C) improperly installed, (D) repaired by someone other than warrantor for a defect or malfunction covered by this warranty, (E) used in a manner or purpose for which the Product was not intended, or (F) sold by the original purchaser.

STATEMENT OF REMEDY: In the event that the product does not conform to this warranty at any time while this warranty is in effect, warrantor will repair the defect and return it to you without charge for parts, service, or any other cost incurred by warrantor or its representatives in connection with the performance of this warranty. THIS WARRANTY DOES NOT COVER OR PROVIDE FOR THE REIMBURSEMENT OF PAYMENT OF INCIDENTAL OR CONSEQUENTIAL DAMAGES. Some states do not allow this exclusion or limitation of incidental or consequential damages so the above limitation or exclusion may not apply to you.

WARRANTY REGISTRATION CARD: In order to facilitate the servicing of this warranty by warrantor, the Warranty Registration Card should be returned to the warrantor. However, return of the Warranty Registration Card is not a precondition of this warranty, and this warranty will be observed by the warrantor whether or not the Warranty Registration Card is returned, provided that other satisfactory evidence of the date of purchase is provided.

PROCEDURE FOR OBTAINING PERFORMANCE OF WARRANTY: In the event that the Product does not conform to this warranty, the Product should be shipped or delivered, freight prepaid, with evidence of original purchase, to warrantor at:

UNIDEN CUSTOMER SERVICE CENTER
9900 Westpoint Drive
Indianapolis, IN 46250

LEGAL REMEDIES: This warranty gives you specific legal rights, and you may also have other rights which vary from state to state. This warranty is void outside of the United States of America.

PRESIDENT™ HR2600 Product Registration Card

Thank you for choosing a Uniden Personal Communications product. You have chosen one of the most sophisticated, technologically advanced electronic products available. Please fill out the requested information on this card so that we can better understand our customers and their needs. With this information, we can plan new products, advertising, and guide our customer service programs. Thanks for your help.

1. Mr. 2. Mrs. 3. Ms. 4. Miss

5. First Name _____ 6. Initial _____ 7. Last Name _____

8. Street _____ 9. Apt. No. _____

10. City _____ 11. State _____ 12. Zip _____

13. Date of Purchase _____ 14. Serial Number _____
mo. day year

15. Is this the first Ham Radio you have purchased or received as a gift?
 Yes No

16. If No, please specify brand and model number purchased.

A _____
B _____
C _____

17. Where did you purchase the product?

- Department Store
- Discount Store
- Catalog Showroom
- Electronics Specialty Store
- Local Electronics Dealer
- Mail Order
- Gift
- Truck Stop

18. How did you become aware of this product?

- TV Advertisement
- Magazine Advertisement
- Store Display
- Friend's Recommendation
- Salesperson's Recommendation
- Previous Use

19. Please check the factors that most influenced your purchase of the product.

- Style or Appearance
- Price
- Uniden Reputation
- Warranty
- Previous Use
- Features
- Quality

20. Please check your age category

- Under 20
- 20-25
- 26-30
- 31-35
- 36-40
- 41-45
- 46-50
- 51-55
- 56-60
- 61-65
- 66-over

21. Occupation

- Homemaker
- Teacher/Educator
- Professional Driver
- Executive/Administrator
- Civil Servant
- Sales/Marketing
- Clerical
- Farmer/Agriculture
- Military
- Technical/Professional
- Business/Professional
- Craftworker
- Machine Operator/Laborer
- Retired
- Student

22. Please check your approximate family income

- Under \$10,000
- \$10,000-\$19,999
- \$20,000-\$29,999
- \$30,000-\$39,999
- \$40,000-\$49,999
- \$50,000-\$59,999
- \$60,000 & over

Welcome!

To the world of 10 Meter amateur radio communications! You have purchased what we feel to be the finest 10 Meter mobile transceiver available. Your HR 2600 has been designed using the latest state of the art electronics to give you years of trouble free service. To get the most from your HR 2600, please read this operating guide thoroughly.

WARNING: To operate this transceiver, you MUST have an FCC Radio Amateur Operator's license. Operation of this device without a license is ILLEGAL and carries heavy penalties.

Unpacking

Your HR 2600 is supplied with the following items. If any items are missing or appear damaged, DO NOT return the unit to the place of purchase. Instead, contact Uniden Customer Service at (317) 842-2483, 8 am-5 pm EST, Monday through Friday.

- HR 2600 10 Meter Transceiver
- Dynamic Microphone with Channel Up/Down control
- Transceiver & Microphone Mounting Brackets & Hardware
- Power Cord with In-Line fuse holder
- Accessory Plug (Jumpered for internal speaker use)
- Accessory Plug (With wires for connecting accessories)
- This operating guide
- Registration Card (Remove from operating guide, fill out, and mail)

We also recommend that you retain the original box and packing, as it makes a convenient way to transport the unit.

Controls and Functions

1. **Mode Switch** - This control is used to select the desired transmit mode. The modes available are: CW, LSB, USB, AM, and FM.
2. **SWR/CAL Control** - This control is used to adjust the calibration of the SWR meter while in SWR CAL mode.
3. **RIT Control** - The Receiver Incremental Tuning control is used to fine tune the received signal. This is used in USB and LSB modes to obtain maximum clarity of reception, and in CW mode to control the pitch of the beat note. The RIT control can tune the receive frequency about ± 3 kHz. This control will not affect the transmit frequency, or the frequency display, but will change the receive frequency.
4. **RIT Switch** - This switch enables or disables the RIT control. Press to enable (button down). Press again to disable (button up).
5. **RF Gain Control** - This is used to vary the RF input to the receiver. This control is used to help eliminate strong, adjacent signals.
6. **Mic Gain Switch** - Pressing this switch activates the built-in microphone attenuator. This feature is designed to be used when operating the HR 2600 in high ambient noise environments.
7. **TX Switch** - The TX switch is used to lock the transmitter on for tuning purposes, except in CW mode. In CW mode the external key must be locked down. The microphone is disconnected unless the PTT switch is also depressed.
8. **Meter Switch** - This switch is used to select the operating mode for the multifunction meter. The meter modes are: S/RF, Modulation, SWR Calibration setting, and SWR. Each time the Meter switch is pushed, the next mode is selected. See the operation section for more information on meter usage. The currently selected mode is displayed above the meter.
9. **NB Switch** - Pressing this switch enables the built in noise blanker. The noise blanker in your HR 2600 is very effective in eliminating interference generated by vehicle ignition systems.

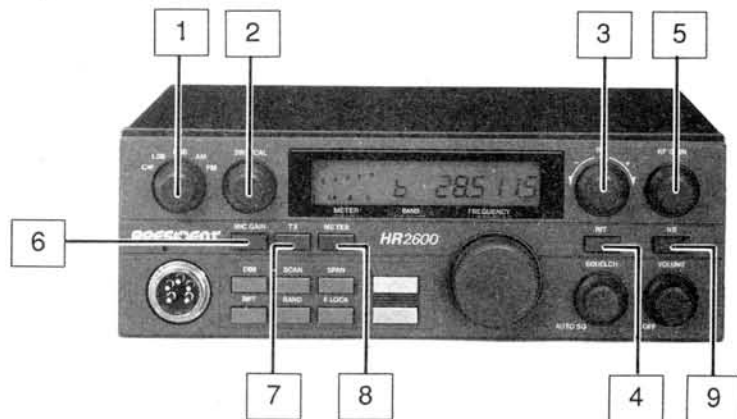

Place
First Class
Stamp
here

uniden®
4700 Amon Carter Blvd.
Fort Worth, TX 76155

Attn: PC Market Research Department

Please do not send any products or service related correspondence to this address

23. What type of car(s) do you drive?

- Compact
- Mid Size
- Sports
- Full Size
- Station Wagon
- Van
- Recreational Vehicle
- Specialty
- Motor Cycle
- Pick Up

25. What types of credit cards do you use?

- American Express, Diner's Club, Carte Blanche
- Bank Cards (Master Card, Visa, etc.)
- Gasoline Card, Name _____
- Department Store Card
- None of the above

24. What magazine(s) do you read?

- Road & Track
- Car & Driver
- Motor Trend
- Auto Week
- American Trucker
- Road King
- Playboy
- Sports Illustrated
- Penthouse
- Time
- Newsweek
- Popular Science
- QST
- CQ
- 73
- Popular Mechanics
- Consumer Reports
- People

© 1989 Uniden Corporation of America

Instructions: Fill out both sides of card. Fold on dotted line. Fold over flap and seal with glue or paste. Affix postage and mail.

Please Fold Here

Amateur Radio Operation - continued

Eventually, you'll probably want to get another, higher class of amateur license, with more privileges. Exams for Technician, General, Advanced, and Extra Class licenses are given by three-member Volunteer Examiner Teams. Hundreds of exam sessions are held across the country every month, most on weekends. (You can take the Novice exam from a Volunteer Examiner Team, too, if it's more convenient.) When you're ready, you can get a schedule of exam opportunities in your area from the ARRL.

We've mentioned the ARRL several times. That's because the League is the national organization that represents Amateur Radio in the United States. The League has more than 150,000 members; most of them hams, but including lots of hams-to-be. Here's the address of ARRL Headquarters:

The American Radio Relay League
225 Main Street
Newington CT 06111

The ARRL staff helped us prepare this section of the operating guide, and they would be glad to hear from you if you need more information, or if you'd like to join! Amateur Radio is a great hobby that has enriched the lives of millions of people the world over. President is proud to be able to bring you the HR 2600 to enrich your life.

Controls and Functions - continued

10. **Dim Switch** - Pressing the Dim switch dims the display backlighting. Press again to return backlighting to its normal (high) level.
11. **Scan Switch** - The Scan control is used to scan up to 100 frequencies in each band segment. See the section on operation for more information on using the Scan Control.
12. **Span (Step Size) Switch** - This control is used to select either 10 kHz, 1 kHz, or 100 Hz steps for the VFO. The currently selected step is indicated by a line under the relevant digit on the Frequency Display.
13. **Λ and V** - Pressing these controls will step up or down in frequency by the amount of the span control.
14. **Band Switch** - Pressing this control will select one of the four band segments. Band segments are: **a**:28.0000 - 28.4999, **b**:28.5000-28.9999, **c**:29.0000-29.4999, and **d**:29.5000-29.6999 MHz. The currently selected band segment is displayed next to the frequency display.
15. **F. Lock Switch** - Pressing the Frequency Lock button will disable all frequency determining controls on the front panel (except RIT) and on the microphone, to prevent accidental changes of frequency.
16. **Digital VFO Control** - The Variable Frequency Oscillator control is used to select the desired transmit and receive frequency. Tuning is continuous throughout the entire range of the HR 2600, with no need to select band segments.
17. **Squelch Control** - The Squelch control is used to adjust the squelch function, which eliminates the "rushing" sound between transmissions. Turning the squelch control CCW until it clicks enables the auto squelch, eliminating the need to manually adjust the squelch.
18. **On/Off/Volume Control** - This control is used to turn the unit on or off and to adjust the volume.
19. **RPT Switch** - Pressing this control enables the 100 kHz frequency split for FM repeater operation. When selected, a "P" is displayed above the band segment display.

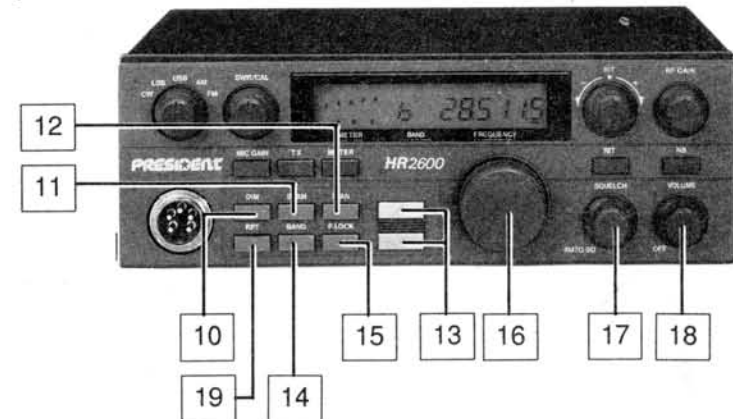

Controls and Functions - continued

- 20. **Multifunction Meter** - This meter can display S/R/F, Modulation, SWR Cal, or SWR. See item (8), Meter Switch and the operation section for more information.
- 21. **Frequency Display** - The Frequency Display displays the currently selected transmit and receive frequency.
- 22. **Meter Mode Display** - Displays the currently selected meter operating mode.
- 23. **Band Segment Display** - Shows the currently selected band segment.
- 24. **Repeat Mode Display** - Shows a "P" if repeater mode is selected.
- 25. **TX Indicator** - Illuminates when PTT or TX Switch is pressed, or CW key is down.
- 26. **VFO Step Indicator** - Displays the currently selected VFO step. (The photo shows 100Hz step selected).

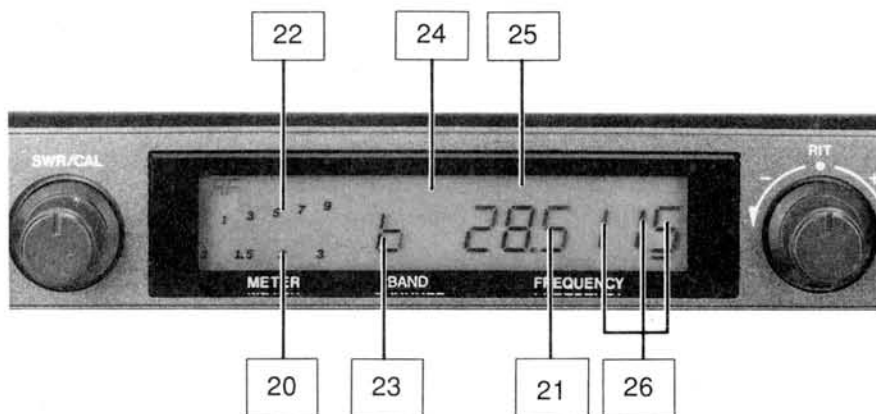

- 27. **Remote \wedge and \vee switches** - You can step up or down by the setting of the span control using these controls. See the section on operation for more information.
- 28. **PTT Switch** - The Push to Talk switch is used to control the transmit and receive of your HR 2600. Press to transmit, and release to receive.

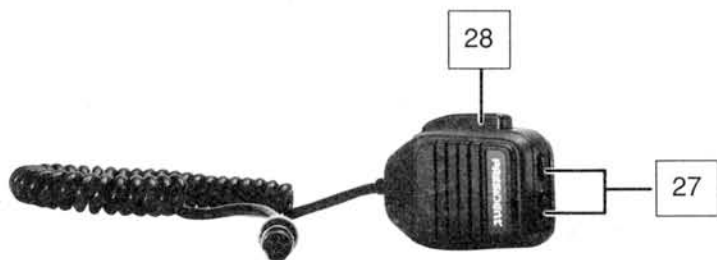

Amateur Radio Operation

Your new President transceiver is designed to be the perfect "first radio" for anyone entering the exciting world of Amateur Radio. From your home, car, or boat, you will find that it opens a door to the world — literally! All you need is a source of electrical power, a suitable antenna, and most important of all, an Amateur Radio Operator's License issued by the Federal Communications Commission (FCC).

You may already have a license. In fact, you may have been a ham operator for many years. But if you don't have a license, you'll find that it's easy to get one, and there is lots of help available. Here are a few tips to help you get started.

First, go ahead and hook up the equipment. Use the receiver section to find out what's going on. *But don't even think of transmitting until you get your license.* That's very important. Transmitting without a license is a violation of Federal Law that could lead to severe penalties. Also, ham operators take the FCC rules very seriously and want nothing to do with "bootleggers" — their term for people who operate without a license.

Second, find out if there's a ham radio club in your area. There are thousands of them across the country, so there's probably at least one in or near your own community. The people at the store where you bought your equipment may be able to tell you. If not, and you don't hear anyone talking about a local club in your area as you tune around the band with your receiver, write to the American Radio Relay League at the address at the end of this section for information on how to contact their local affiliate. Most clubs welcome newcomers, and would be glad to help you obtain your license.

Next, start studying for your license. Don't let the word "study" scare you, because most people can go from knowing absolutely nothing about radio to passing the basic (Novice) class license exam in less than 40 hours of study spread out over several weeks. The test will be on basic radio regulations, a little bit of radio theory, and slow speed Morse Code. Many clubs teach license classes (a fun and easy way to learn about Amateur Radio), and there are good books, cassette tapes, computer programs, and lots of other study aids available. The ARRL publishes a book, Tune in the World with Ham Radio which is usually packaged with two tape cassettes and has all you need to know. But, don't overlook the products of commercial publishers that you will see in radio and electronics stores.

Finally, you'll be ready to pass the exam. You won't have to go to an imposing Federal office building in a big city to take the test, because these days, the FCC has ham volunteers give all of the exams. For the Novice license, the examiners can be any two hams with General or higher class licenses who are at least 18 years old and not related to you. And, the Novice exam is free!

The Novice class license will let you use your HR 2600 between 28.1 and 28.5 MHz — on CW (Morse Code) between 28.1 and 28.5 MHz, and on SSB (voice) between 28.3 and 28.5 MHz. Your HR 2600 has more frequencies and operating modes built in, which you will be able to use once you have a General or higher class license. There's no rush — your Novice license will be good for ten years, and even then you can renew it indefinitely.

Troubleshooting

If your HR 2600 is not performing up to your expectations, please try these simple steps. If you still cannot get satisfactory results after reading this manual and following the troubleshooting steps, please contact Uniden Customer Service at: (317) 842-2483.

Trouble	Check
Unit will not turn on No Power	<ol style="list-style-type: none"> 1. Check power cord and all connections. 2. Check power cord fuse. 3. Check vehicle electrical system. 4. Check unit grounding.
Poor Reception	<ol style="list-style-type: none"> 1. Check & adjust squelch. 2. Check antenna. 3. Check antenna cable. 4. Check antenna connectors. 5. Check operating mode of radio.
Weak Transmission	<ol style="list-style-type: none"> 1. Check antenna. 2. Check antenna cable. 3. Check antenna connectors. 4. Check operating mode of radio. 5. Check antenna SWR. 6. Check antenna grounding. 7. Check for corrosion on connectors.

Front Panel Connector

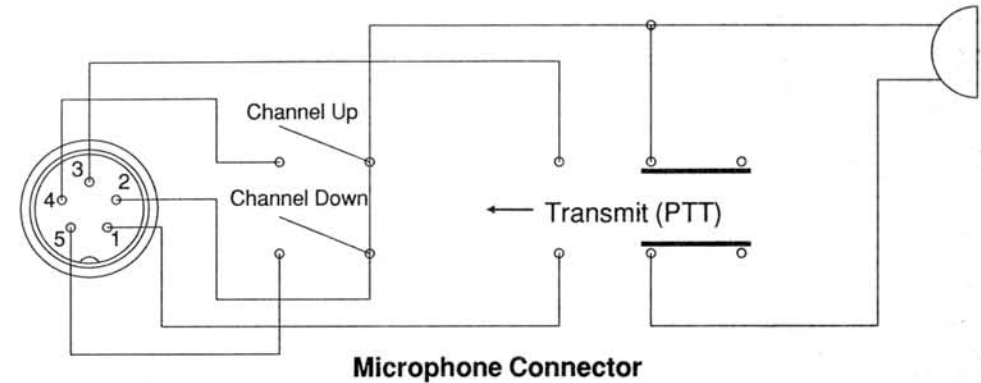

The microphone included with the HR 2600 is a 500Ω dynamic microphone, with frequency up and down switches. The view of the connector is facing the HR 2600 front panel. The pin connections are as follows:

Pin	Connection
1 & 2	Microphone
3 & 2	PTT Switch
4 & 2	Channel Up Switch
5 & 2	Channel Down Switch
2	Common Ground

CTCSS Control

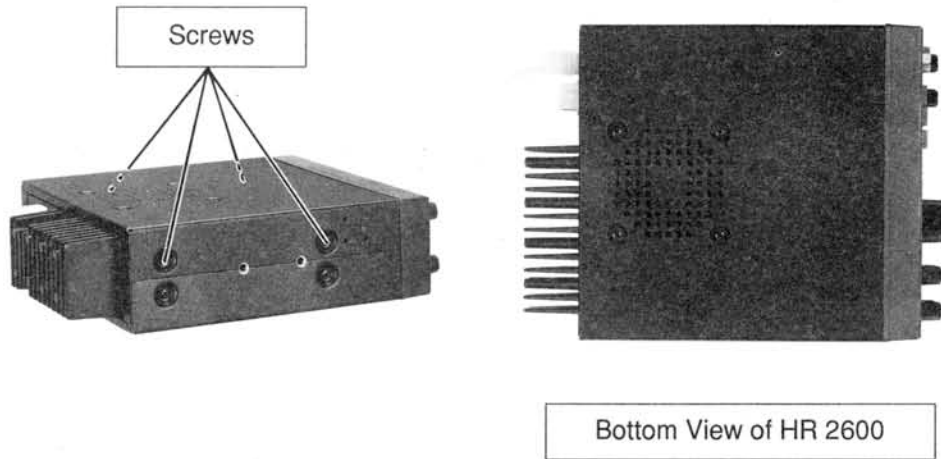

Setting & Using CTCSS

The HR 2600 has a built-in CTCSS encoding (Continuous Tone Coded Squelch System) for accessing repeaters. CTCSS is activated only in FM RPT mode of operation. To set the CTCSS frequency, proceed as follows:

1. Place the unit top down on a non-scratching surface.
2. Remove the cover screws for the bottom half of the case (see photo above). Use caution when removing the bottom half of the case, since the speaker is connected to the main board. Do not pull on the wires.
3. Using the table at the right, set S301 for the desired CTCSS frequency. If no CTCSS tone is desired, place all switches (S301-1 through S301-6) into either the on or off position.
4. Replace the cover and securely fasten using the screws. Do not overtighten the screws, or damage to the threads may result.
5. To use CTCSS encode mode, place the mode switch into the FM position, and press the RPT switch (down position). You are now ready for CTCSS encoded repeater operation.

*Note: The CTCSS board in the HR 2600 is **encode only**. Receiver operation is normal carrier squelch.*

Specifications

General

Frequency Range	Band A	28.0000-28.4999 MHz
	Band B	28.5000-28.9999 MHz
	Band C	29.0000-29.4999 MHz
	Band D	29.5000-29.6999 MHz
Frequency Stability	± 300 Hz Nominal, (@25°C, 5 Minutes after Power on)	
Microphone	500Ω Dynamic, w/PTT and Frequency Up/Down	
Speaker	8Ω, 5W Max.	
Operating Modes	CW, USB, LSB, AM, FM	
Display	Backlit LCD	
Display Items	Frequency, Band, Repeater (split) mode, Meter, Meter Mode, TX, VFO Span	
Size	7.32" W x 10.35"D x 2.44"H	
Weight	4 lbs 3 oz	

Transmitter

Output Power	CW 25 W Nominal
	USB/LSB 25W PEP Nominal
	AM/FM 10W Nominal
Spurious Harmonic Emissions	-50dB Nominal, all modes
Carrier Suppression	-55 dB Nominal, USB/LSB Modes
Unwanted Sideband Suppression	-45 dB Nominal, USB/LSB Modes
Power Consumption (No Modulation, PTT Depressed)	AM/FM 3A Nominal
	USB/LSB 0.8A Nominal
	CW 5A Nominal (Key Down)
(Max Modulation) Microphone Input	AM/FM 3A Nominal, USB/LSB 5A Nominal
CW Key Voltage/Current	1 mV Nominal for 50% AM Modulation
	8V DC, 10 mA

Receiver

Sensitivity for 10 dB S/N	AM .5 μV Nominal
	CW/USB/LSB .25 μV Nominal
Sensitivity for 20 dB SINAD	FM .5 μV Nominal
Adjacent Channel Selectivity	70dB Nominal (10 kHz Spacing)
Max. Audio Output	4W Nominal
RF Gain Range	55 dB Nominal
RIT Range	± 3 kHz Nominal
"S" Meter Sensitivity @ S9	100 μV Nominal
Image Rejection Ratio	65 dB Nominal
Power Consumption, Squelched	500 mA Nominal
Power Consumption, Max Audio	1000 mA Nominal

Operation - continued

SWR Meter

After you have calibrated the SWR Meter according to the SWR CAL procedure previously shown, you are ready to proceed to check the SWR of your HR 2600 and antenna. Press the **Meter** button until "SWR" is displayed above the meter (once after completing the SWR CAL procedure). At this point, pressing the **PTT** switch on the microphone if in AM or FM mode, or pressing the CW key if in CW mode will transmit a signal. As you transmit, your SWR will be displayed on the meter.

Warning: Standing Wave Ratios in excess of 2:1 may cause transmitter damage.

CTCSS Control - continued

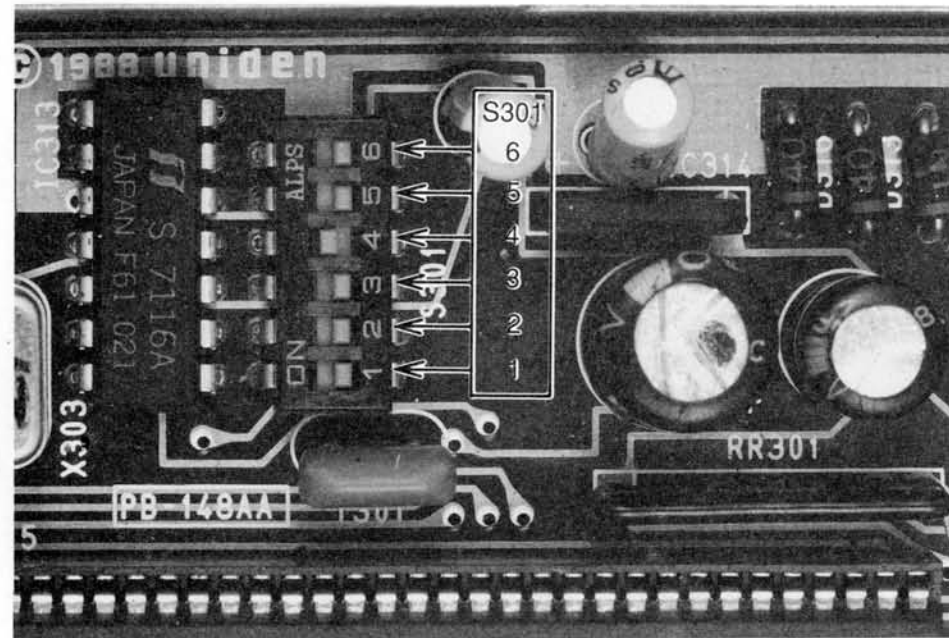

Switch Settings for S301 (H=ON)

CTCSS	EIA	1	2	3	4	5	6	CTCSS	EIA	1	2	3	4	5	6
XZ	67.0	H						3B	131.8			H			H
XA	71.9		H					4Z	136.5	H		H			H
WA	74.4	H	H					4A	141.3		H	H			H
XB	77.0			H				4B	146.2	H	H	H			H
WB	79.7	H		H				5Z	151.4				H	H	
YZ	82.5		H	H				5A	156.7	H			H	H	
YA	85.4	H	H	H				5B	162.2		H		H	H	
YB	88.5				H			6Z	167.9	H	H		H	H	
ZZ	91.5	H			H			6A	173.8			H	H	H	
ZA	94.8		H		H			6B	179.9	H		H	H	H	
ZB	97.4	H	H		H			7Z	186.2		H	H	H	H	
1Z	100.0			H	H			7A	192.8	H	H	H	H	H	
1A	103.5	H		H	H			M1	203.5						H
1B	107.2		H	H	H			M2	210.7	H					H
2Z	110.9	H	H	H	H			M3	218.1		H				H
2A	114.8					H		M4	225.7	H	H				H
2B	118.8	H				H		M5	233.6			H			H
3Z	123.0		H			H		M6	241.8	H		H			H
3A	127.3	H	H			H		M7	250.3		H	H			H

Rear Panel Connectors

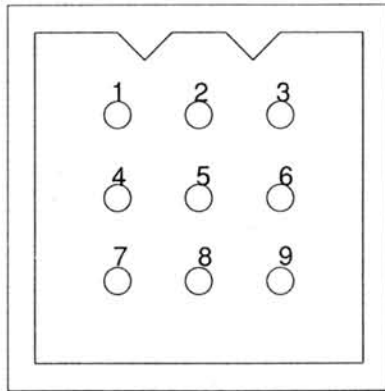

Accessory Connector

There are two plugs for the accessory connector included with your HR 2600. One plug contains only a jumper between pins 1 and 7, which is used only to enable the internal speaker. The other plug is wired so that you can conveniently connect accessories to your HR 2600. The view of the connector is facing the rear panel of the unit. The pin connections and wiring color codes are as follows:

Pin	Wire Color	Connection
1 & 2	Red/Black	External Speaker
4 & 5	Blue/Black	N.C.
8 & 9	Black/Yellow	CW Key (Yellow wire (pin 9) is "hot" side (positive) if there is any polarity on the key.)
1 & 7	Red/White	Internal Speaker (Jumper to use internal speaker, open if external speaker is connected.)
3 & 6	n.c.	

Power Connector

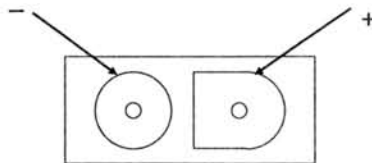

The power cord included with the HR 2600 is color coded. The red wire goes to +13.8 V DC nominal and the black wire goes to ground. The HR 2600 is designed for operation with a negative ground system only. The view of the power connector is facing the rear panel of the HR 2600.

Operation - continued

Multifunction Meter

The Multifunction Meter built in to your HR 2600 provides a number of useful functions. These are:

- S/RF Meter
- MOD Meter
- SWR CAL Meter
- SWR Meter

Every time you press the **Meter** button, the next function will be selected. When you reach the end of the functions, it will start over with the first. When in receive mode, the meter is always in the "S" function. (Received signal strength.)

S/RF Meter

The S/RF meter function provides a visual indication of relative received signal strength and relative transmit power. To use the S/RF function, press the **Meter** button until "RF" is displayed over the meter display. The meter automatically switches function depending on whether you are transmitting (RF Mode) or receiving (S mode).

MOD Meter

This function gives you an indication of the strength of your modulation when transmitting. There is no function for this meter when receiving signals. To use the MOD function, press the **Meter** button until "MOD" is displayed over the meter display.

SWR CAL Meter

Note: SWR Calibration may be performed in the AM or FM modes.

This mode of the multifunction meter is used to calibrate the meter for the SWR function. To use this mode, press the Meter button until the small triangle is visible under the meter, near the right side. No other meter mode indications will be visible at the same time. Press the **PTT** switch on the microphone or the **TX** button in AM or FM modes, or hold down the CW key in CW mode, and adjust the meter so that it indicates to the triangle. Use the SWR CAL control for the adjustment. When you have done this, you are ready to check the SWR.

Note: Don't forget that all transmissions must be properly identified, and remember to listen on the frequency before transmitting.

Operation - continued

CW Operation

Using CW mode with the HR 2600 is easy. Just select your operating frequency, place the mode switch in CW, and you're ready to transmit CW if you have connected an external key to the accessory plug on the rear of the unit. (See the section on rear panel connectors for information on connecting a CW key.)

To use CW mode with an external key, select an operating frequency, place the mode switch in CW, and you are now ready to operate as semi break-in CW mode. (If you leave the key up for more than .5 second, the receiver is enabled. The HR 2600 has a built-in sidetone oscillator for your convenience. Note: If the TX switch is depressed, the receiver will be disabled. The HR 2600 will NOT transmit in CW mode unless an external key is connected and in a key down condition.

To adjust the pitch of the received CW note, you can use either the VFO or RIT to tune it as desired. If you initiated transmission, use the RIT control to adjust the pitch. If you are answering a call, use the VFO to adjust the pitch to about 800 Hz to zero-beat the signal with the RIT off. (Note: Adjusting the RIT will NOT affect the frequency display)

Receive Scanning

The receive scanning functions of your HR 2600 make it easy to find active frequencies. You can scan 100 5 KHz channels in segment a,b,or c, and 40 channels in segment d. Scanning is always from the lower frequency to higher frequencies, and always in 5 KHz steps.

Scanning Operation

To begin scanning, press the **Scan** button. If there is a transmission on the current frequency (the squelch is broken open), pressing the **Scan** button will just step up 5 KHz. If the squelch is NOT broken, scanning will begin.

The unit will scan through the selected band segment until it encounters a signal strong enough to break (open) the squelch. It will then stop on that frequency for the duration of the transmission. When the transmission stops, the HR 2600 will wait approximately 1.5 seconds before resuming the scan cycle, to allow you to hear a return transmission on that frequency. If you take no further action, the scan will resume.

When the scan has stopped for a transmission, momentarily pressing the \wedge or V switch on the microphone will stop the scan on the frequency.

To exit from scan mode while still scanning, simply press either the \wedge or V button on the microphone or front panel, or **Scan**, **F. Lock**, or **Band**. If the scan has stopped on an active frequency, you can press the \wedge and V buttons on the microphone, or the \wedge and V, **F. Lock**, or **Band**, buttons on the front panel of the HR 2600.

Rear Panel Connectors - continued

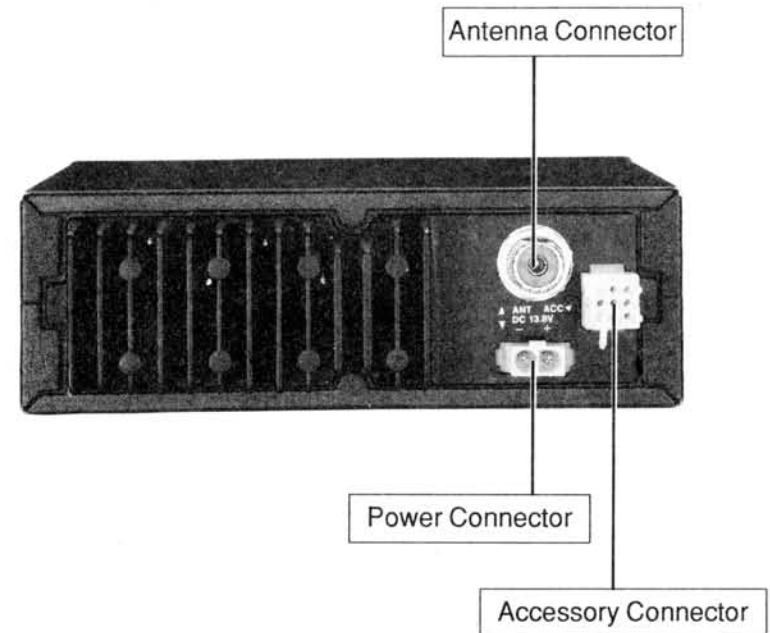

Antenna Connector

The antenna connects to an ordinary SO-239 Female RF connector on the rear panel. The RF output impedance is 50 Ω

Warning: Standing Wave Ratios in excess of 2:1 may cause transmitter damage.

Installation

Transceiver Mounting

Plan the location of the transceiver and microphone bracket before starting the installation. Select a location that is convenient for operation and does not interfere with the driver or passenger in the vehicle. The radio should be secured to a solid surface, using the mounting bracket and self-tapping screws supplied.

Mobile Antenna

The antenna is a very important factor affecting transmission and reception. It is for this reason that we strongly recommend that you install only a quality antenna in your new HR 2600 system. You have purchased a superior quality transceiver; don't diminish its performance by installing an inferior antenna.

Only a properly matched antenna system will allow maximum power transfer from the 50Ω transmission line to the radiating element. Your Uniden dealer is qualified to assist you in the selection of the proper antenna to meet your application requirements.

For automobile installations, a quarter wave whip antenna may be used with good effect. The most efficient and practical installation is to mount it on the rear deck or fender top midway between the rear window and bumper.

A short base loaded whip antenna is more convenient to install, but the efficiency is less than a quarter wave whip.

For marine installations, consult your dealer for information regarding an adequate grounding system and prevention of electrolysis.

Warning: *Standing Wave Ratios in excess of 2:1 may cause transmitter damage.*

Ground Information

Most newer U.S. and foreign made cars and small trucks use a 13.8 V DC nominal negative ground system, while some older cars and large trucks use a positive ground system. A negative ground system is generally identified by the negative (-) battery terminal being connected to the vehicle frame or engine block, but if you cannot determine the polarity of your vehicle or are unsure, contact your vehicle dealer for definite information.

Warning: *Your HR 2600 is designed for operation on a 13.8 VDC nominal, negative ground system only. Operation on other voltages or polarities may cause fires, transceiver damage, and/or other hazards.*

Power Cord Connection

The red lead (with the inline fuse) of the supplied power cord is to be connected to a "hot" (positive) wire, and the black lead to ground. As the HR 2600 draws appreciable current during transmitting, you may wish to connect the positive lead directly to the battery, or to a main supply wire.

Operation

Selecting a frequency

VFO Operation

Selecting an operating frequency using the HR 2600's built-in VFO is easy. Make sure that the **F. Lock** key is NOT depressed, and then simply rotate the dial, or use the \wedge and \vee buttons on the microphone or front panel until the desired operating frequency is displayed. The VFO will step in either 10 KHz, 1 KHz, or 100 Hz increments. The step increment is indicated by a line under one of the 3 rightmost digits of the frequency display. To change the VFO step, press the **Span** button until the desired step is indicated by the black line. When using the VFO, you do not need to manually select the band segment, as this is done automatically, so that tuning is continuous throughout the entire operating frequency range.

Repeater Operation

For working FM repeaters, press the **RPT** button on the front panel. A "P" will be displayed over the band segment display. When in this mode, the transmit frequency is 100 KHz lower than the receive frequency.

USB/LSB/AM/FM Operation

Using the HR 2600 for voice communications as either USB, LSB, AM or FM modes is simple. Simply select your desired operating frequency, turn the mode switch to the desired type of operation, and the **PTT** switch controls the transmit and receive. To fine tune the receive signal in USB or LSB, you can use either the VFO or RIT controls. (Note: Using the RIT control to fine tune the receive frequency will NOT affect the frequency display.)

The Mic Gain control can (and should) be used when you are transmitting from a high ambient noise environment. Pressing the **Mic Gain** control reduces the gain of the transmit audio amplifier. Press the **Mic Gain** control again to restore it to normal operating condition.

Noise Blanker

The noise blanker has been designed specifically to remove the interference generated by vehicle ignition systems. To use the noise blanker, simply press the **NB** switch. To disable the noise blanker, just press the **NB** switch again.

F. Lock

The Frequency Lock function is used to lock the frequency determining controls against accidental changes. To lock the frequency controls, press the **F. Lock** button. To unlock the frequency controls, press **F. Lock** again.

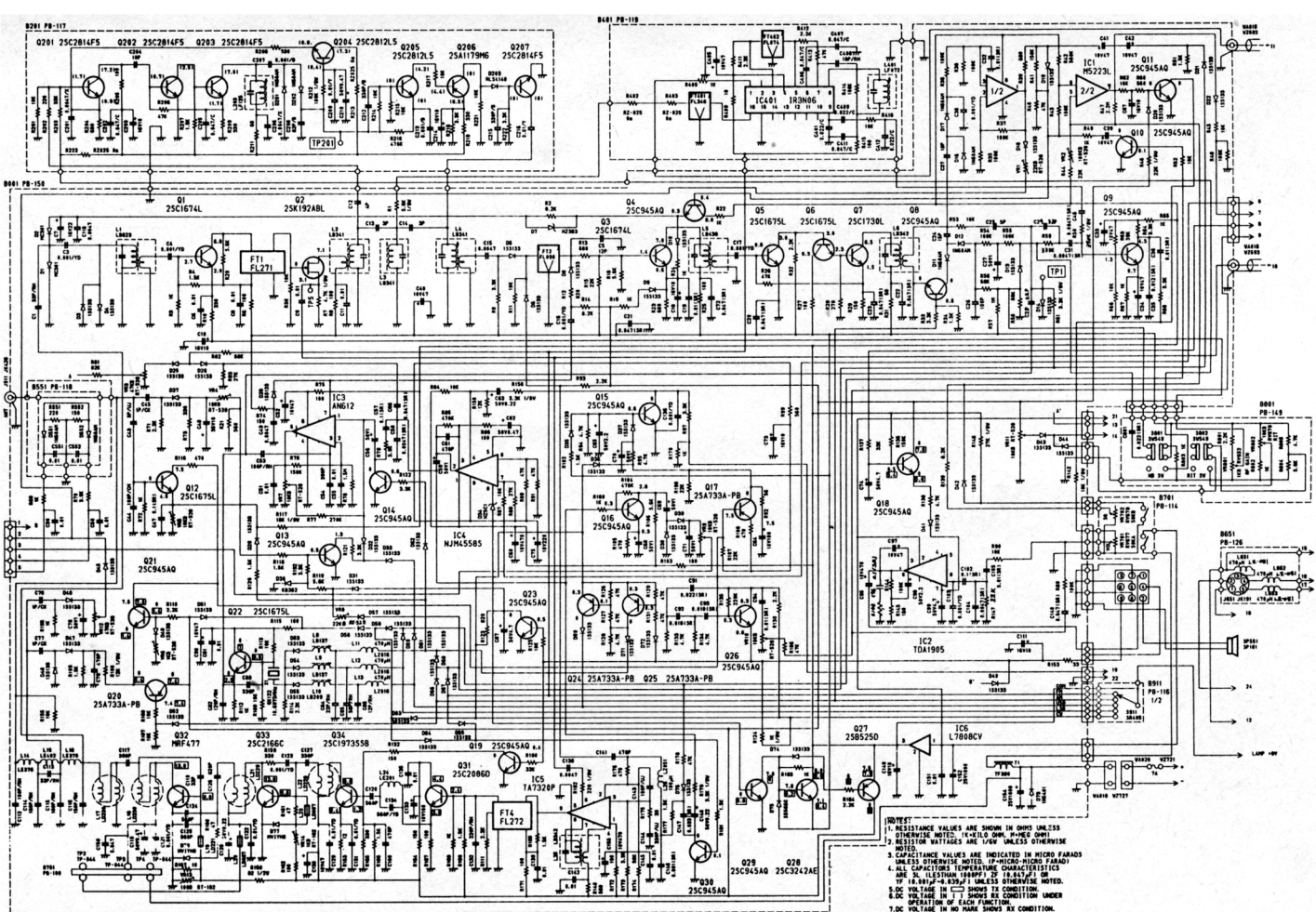

NOTES:
 1. RESISTANCE VALUES ARE SHOWN IN OHMS UNLESS OTHERWISE NOTED; 1K=1,000 OHMS, 1M=1,000,000 OHMS.
 2. RESISTOR RATINGS ARE LOW UNLESS OTHERWISE NOTED.
 3. CAPACITANCE VALUES ARE INDICATED IN MICROFARADS UNLESS OTHERWISE NOTED; 100P=100 MICROFARADS.
 4. ALL CAPACITORS TEMPERATURE CHARACTERISTICS ARE 10% UNLESS OTHERWISE NOTED.
 5. DC VOLTAGE IN \square SHOWS BY CONDITION UNDER OPERATION IN EACH FUNCTION.
 6. DC VOLTAGE IN \square SHOWS BY CONDITION UNDER OPERATION IN EACH FUNCTION.
 7. DC VOLTAGE IN \square SHOWS BY CONDITION UNDER OPERATION IN EACH FUNCTION.

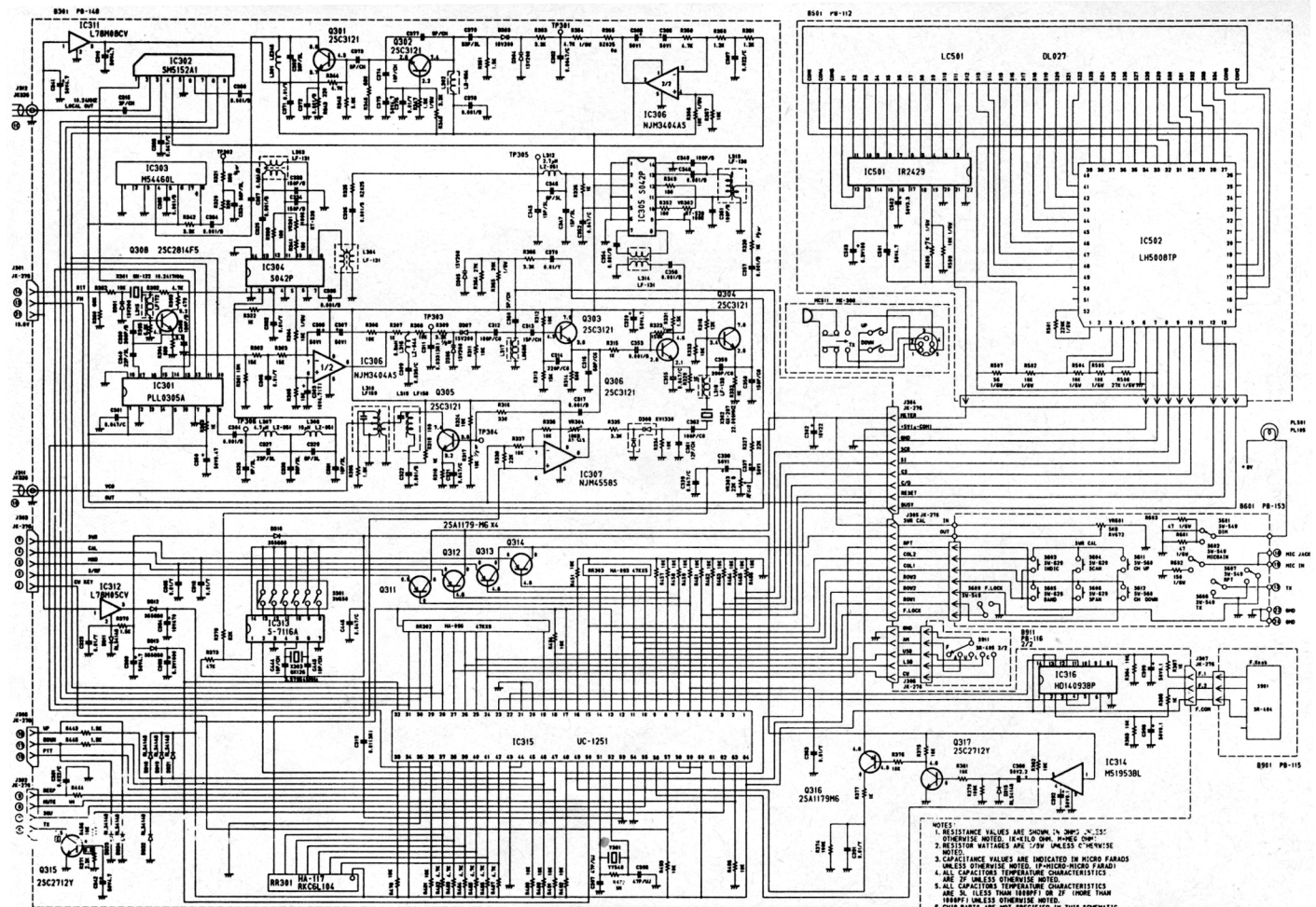

- NOTES:
1. RESISTANCE VALUES ARE SHOWN IN OHMS UNLESS OTHERWISE NOTED. 1K=1,000 OHMS, 1M=1,000,000 OHMS. RESISTOR NOTATIONS ARE 20% UNLESS OTHERWISE NOTED.
 2. CAPACITANCE VALUES ARE INDICATED IN MICRO FARADS UNLESS OTHERWISE NOTED. 1P=1-PICO-FARAD (10⁻¹² FARAD).
 3. ALL CAPACITORS TEMPERATURE CHARACTERISTICS ARE 20% UNLESS OTHERWISE NOTED.
 4. ALL CAPACITORS TOLERANCE CHARACTERISTICS ARE 20% UNLESS OTHERWISE NOTED.
 5. ALL CAPACITORS TEMPERATURE CHARACTERISTICS ARE 20% UNLESS OTHERWISE NOTED.
 6. CHIP PARTS ARE NOT SPECIFIED IN THIS SCHEMATIC DIAGRAM.
- PLEASE REFER TO THE PARTS LIST FOR THE CHIP PARTS.