

EM-27

Professional 80 Channel Mobile CB Transceiver

OWNER'S MANUAL



maycom

EM-27 CB Transceiver

The user's manual for the EM-27 CB Transceiver covers how to install the transceiver, how to use the transceiver, its features and operational methods. In order to get the best performance from your EM-27 CB transceiver, please read the instruction manual before initial use.

CONTENTS

	PAGE
■ INTRODUCTION	4
■ FEATURES AND CONTROLS	5
Fig A. FRONT PANEL INFORMATION	5
Fig B. LCD DISPLAY INFORMATION	12
Fig C. THE MULTI-FUNCTION MICROPHONE INFORMATION	15
■ SPECIAL FEATURES	17
■ HOW TO INSTALL YOUR EM-27	19
■ SPECIFICATIONS	24

■ INTRODUCTION

The model EM-27 is an advanced mobile CB transceiver that combines propriety circuitry with microprocessor controlling system, full surface mount technology and advanced user features to make it the premier radio in CB mobile communications.

The following standard features are included.

- Fully Synthesized System with Micro Processor
- 80 Channels (40 CH FM UK + 40 CH FM CEPT/EU)
- Large LCD Multi-Function Display
- Full scanning of all channels or only pre-set memory channels
- Dual Watch
- Automatic Control of Low Audio Level in accordance with Noise Strength
- Key Lock System
- 7 Dual Function / Memory Buttons
- Instant Access to Channel 9 or 19
- Direct Display of supplied Voltage
- Beep On or Off switch
- Six user defined functions on the Microphone out of functions from the front panel
- Rotary Channel-Volume and Squelch Controls
- Back Lit Illumination
- Last Channel Recall
- External Speaker Socket
- All metal cabinet
- High performance Chassis

■ FEATURES AND CONTROLS

FIG A. - FRONT PANEL INFORMATION

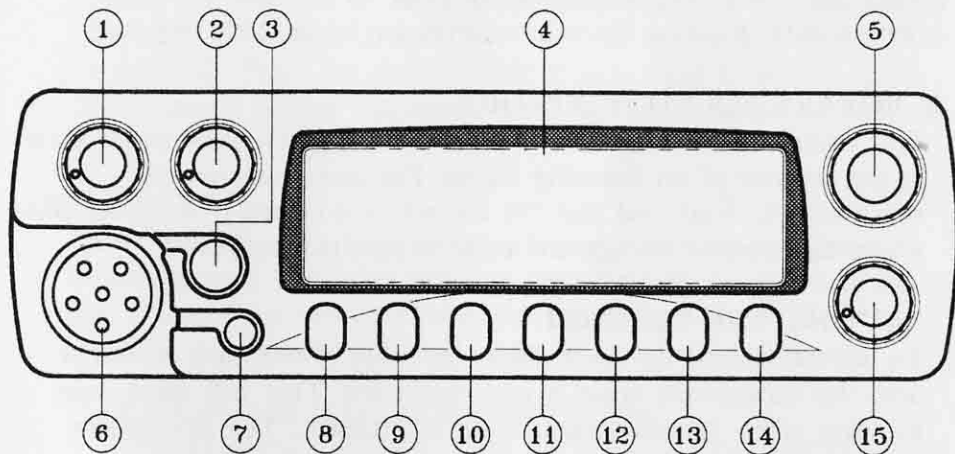

FIG

FUNCTION / PURPOSE

- | | |
|----|-------------------------|
| 1. | ROTARY VOLUME CONTROL |
| 2. | ROTARY SQUELCH CONTROL |
| 3. | PUSH POWER ON/OFF |
| 4. | LCD |
| 5. | ROTARY CHANNEL SELECTOR |
| 6. | 6 PIN MIC SOCKET |

MULTI FUNCTION PRESS BUTTONS

	FUNCTION 1	FUNCTION 2	FUNCTION 3
7.	RECALL	MEMORY	nil
8.	MEMORY 1	FUNCTION	nil
9.	MEMORY 2	LCR	BATTERY
10.	MEMORY 3	SCAN	DUAL WATCH
11.	MEMORY 4	AUTO-Q	nil
12.	MEMORY 5	MONITOR	LOCK
13.	MEMORY 6	BEEP	UK/EU
14.	MEMORY 7	EMERGENCY	nil
15.	ROTARY R.F. GAIN CONTROL		

DESCRIPTIONS AND FUNCTIONS OF CONTROLS

1. ROTARY VOLUME CONTROL

Turn the rotary volume control clockwise to increase and anti-clockwise to decrease the volume level for comfortable reception.

2. ROTARY SQUELCH CONTROL

This control is used to cut off or eliminate receive background noise in the absence of an incoming signal. For maximum receiver sensitivity, it is advised that the control be adjusted only to the point where the receiver background noise is just eliminated.

SETTING THE SQUELCH

To set the control turn anti clockwise fully, slowly turn clockwise until the background noise is just eliminated. This will allow quiet listening when incoming signals are not present. The Microphone should be connected otherwise the internal loudspeaker will not be heard.

3. POWER PRESS ON/OFF SWITCH

Press "PWR" button to switch on the C.B transceiver.

To switch off the C.B transceiver, press and hold the "PWR" button.

4. LCD (Liquid Crystal Display)

The liquid crystal display panel provides the user with visual information on the operation and status of the EM-27 transceiver.

5. ROTARY CHANNEL SELECTOR

To change channel turn the channel selector clockwise to go up in channel number and frequency; turn the channel selector anti-clockwise to go down in channel number and frequency. Channels and frequency can also be changed up or down with the "▲" or "▼" buttons located on the top of the multi-function microphone.

6. SIX PIN MIC SOCKET

Socket for connection of multi-function microphone.

7. RECALL / MEMORY button (R/M)

(1) RECALL

This feature allows the user to activate the stored channels in the memory buttons. To access channel in the memory buttons simply press the "R/M" button, and then "M" will appear at the right side on the LCD. Press the memory button you want to access. Your desired channel number will appear on the LCD with the corresponding memory button. (M1-M7)

(2) MEMORY

This feature is used to store in to memory buttons your most frequently used channels, allowing immediate access to them for use. There are seven user selectable memory channels. You may program any channel into any of the seven memory buttons.

PROGRAMMABLE MEMORY BUTTONS

To program, select a channel using the rotary channel selector or the "▼" or "▲" buttons on the MIC. Press "R/M" button for 1.5 second. "M" will appear flashing on the right side on the LCD. Select any memory button (M1-M7) and press it, this stores the chosen frequency and channel into the selected memory channel. To change the channel being stored within a memory button, repeat the process described above. The new channel number will be stored over the old channel that was previously stored in that memory button.

8. M1

(1) MEMORY 1

When R/M is pressed and M is showing on right of display M1 button is used to store the channel you want in the memory mode. Or to recall it in Memory mode.

(2) FUNCTION

This button, when used in conjunction with the other buttons on the front panel, allows access to the function of each button. The EM-27 comes pre-programmed with the first function of each button. When the radio is switched on "LCR, SCAN, AUTO-Q, MON, BEEP, EMG" will appear on the LCD.

To access the second function of each button, press the "M1" button once again. Then " BATT, DW, LOCK, UK/EU " will appear at the bottom line on the LCD.

9. M2

(1) MEMORY 2

This button is used to store the channel you want in the memory mode or to select the channel in M mode.

(2) LCR (LAST CHANNEL RECALL)

To activate this feature firstly press the "M1" button, "LCR, SCAN, AUTO-Q, MON, BEEP, EMG" will appear at the bottom line on the LCD. Then press "M2" button, the channel number will revert back to the last channel that the EM-27 was transmitting on.

(3) BATTERY

This feature shows the supplied voltage being delivered to your EM-27 transceiver from your power source.

To access, press "M1" button until "BATT, DW, LOCK, UK/EU, BEEP" will appear at the bottom line on the LCD. Press and hold "M2" button, then supplied voltage will appear at the frequency location on the LCD.

10. M3

(1) MEMORY 3

This button is used to store the channel you want at memory mode.

(2) SCAN

The channel Scan feature allows the radio to automatically scan through all 40 channels, stopping at any channel that is busy. It will remain on that channel during the conversation, and will not reactivate scanning until 5 seconds after the conversation has ceased. In some cases the scanning will stop if there are other airborne noises, the radio will accept this as a busy channel and stop.

To Active Scan:

Press "M1" button, "LCR, SCAN, AUTO-Q, MON, BEEP, EMG" will appear at the bottom line on the LCD. Then press the "M3" button, the word "SCAN" will appear at the top line on the LCD. The radio will start the Scanning upwards. If you want to stop scanning, simply press the "M3" button. In the event that during the scanning process the radio stops on a channel and you wish to speak to the person

on that channel, simply press the Push-To-Talk switch on the mike. This will stop the scanning function and then transmit on that channel. To access the down scanning system, turn the channel switch to the anti-clockwise direction or press the "▼" button on the mike.

MEMORY SCAN

The memory channel Scan feature allows the radio to automatically scan through the memorized 7 channels. To access, press "R/M" button until "M" will appear on the LCD. And then repeat scan process.

(3) DUAL WATCH

The Dual Watch feature give the user the ability to monitor and communicate over two channels virtually simultaneously. An application of this may be when you want to be able to communicate on a "quiet" channel (for example, channel 28), while at the same time monitoring conversation talking place on a very "active" channel (for example, channel 19).

To Operate Dual Watch:

- 1) Press "M1" button, then "BATT, DW, LOCK, UK/EU" will appear at the bottom line on the LCD.
- 2) Select the channel that you want to monitor, which we will refer to as your "Watch Channel".
- 3) Press "M3" button. The "DW" will appear at the top line on the LCD.
- 4) Select the other channel that you want to monitor, using the up/down channel arrows. Once this channel has been selected, the radio will begin its dual watch monitoring in about three seconds.

Note that the second channel selected is the primary channel, with the radio switching to the "Watch Channel" for approximately one second every three seconds. If a signal is received on the "Watch Channel", the radio will change to that channel immediately. If you press the Push-To-Talk switch on the mike when signal is received at the "Watch Channel", the "Dual Watch" feature will turn off. But if you press the Push-To-Talk switch at the second channel the

"Dual Watch" feature will not turn off. To turn off the "Dual Watch" feature, simply press the "M3" button, the "DW" will disappear on the LCD. Note that the radio will return to the "Watch Channel" for normal operation.

11. M4

(1) MEMORY 4

This button is used to store the channel you want at memory mode.

(2) AUTO-Q

This control is also used to cut off or eliminate receiver background noise in the absence of incoming signals. If incoming signal is lower than the squelch level, the audio output will decrease. But, if audio output is the same as the incoming signal, in that case the incoming signal is higher than the squelch level.

To access, press "M1" button, "LCR, SCAN, AUTO-Q, MON, BEEP, EMG" will appear at the bottom line on the LCD. Then press "M4" button, "AUTO-Q" will appear at the top line on the LCD and the incoming signals will be stronger than the background noise. To stop, press "M4" button once again.

12. M5

(1) MEMORY 5

This button is used to store the channel you want at memory mode.

(2) MONITOR

This feature is used to listen to weak signals that repeatedly open and close the squelch without changing the squelch setting. When receiving a weak signal, push and hold this button to open the squelch completely. To access, press "M1" button, then "LCR, SCAN, AUTO-Q, MON, BEEP, EMG" will appear at the bottom line on the LCD. Then press "M4" button, "BUSY" will appear on the LCD.

(3) LOCK

The Lock feature allows the user to "lock" virtually all of the buttons on the radio so they can not be activated. This will prevent the radio from having its operation mode to be accidentally changed from that desired by the user. To Activate; press "M1" button until

"BATT, DW, LOCK, BEEP" will appear at the bottom line on the LCD. Press the "M4" button. The "  " appears on the display to indicate that this feature is currently activated.

To De-Activate: Repeat the process described in "To activate". The "  " will disappear from the LCD.

NOTE : "Power", "PTT", "Volume", "Squelch", "MON", and "Lamp" are not affected.

13. M6

(1) MEMORY 6

This button is used to store the channel you want in memory mode

(2) BEEP

Gives the user an audible confirmation through a short beep tone when functions are operated. If you would like to de-activate this feature, simply press "M1" button, "LCR, SCAN, AUTO-Q, MON, BEEP, EMG" will appear at the bottom line on the LCD. After that, simply press "M6" button. When active a musical note sign is displayed in the LCD.

(3) UK/EU

To switch between the UK and EU bands. Press "M1" button until "BATT, DW, LOCK, UK/EU" appears at the bottom line on the LCD. Press the "M6" button, "EU" will appear on the left-hand side of the LCD. To switch back to UK band, simply press "M6" button once again.

14. M7

(1) MEMORY 7

This button is used to store the channel you want at memory mode.

(2) EMERGENCY

The EM-27 has an Emergency button for instant access to both the National Emergency channel 9, which is monitored by police and various safety groups, as well as the most frequently used channel by professional drivers, channel 19. This feature has been designed specifically to give the user fast, simple access to channel

9 the channel that will provide the best avenue in calling for help during an emergency situation. To access channel 9, firstly press "M1" button. "LCR, SCAN, AUTO-Q, MON, BEEP, EMG" will appear at the bottom line on the LCD. After that, simply press the "M7" button once. "EMG" and channel "09" will appear on the LCD. If you would like to access channel 19, simply turn the rotary channel switch to the right-hand or press the "▲" button on the Mike. If you would like to access channel 9 once again, turn the rotary channel switch anti-clockwise or press "▼" button on the mike. To deactivate either of these channels once they have been selected, simply press the "M7" button.

15. R.F. GAIN

This feature controls the Receiver Sensitivity to reduce interference from unwanted strong signals. To decrease RF Gain turn the control switch anti-clockwise. For maximum Receiver Sensitivity the RF Gain control must be rotated fully in the clockwise position.

FIG B. LCD DISPLAY INFORMATION

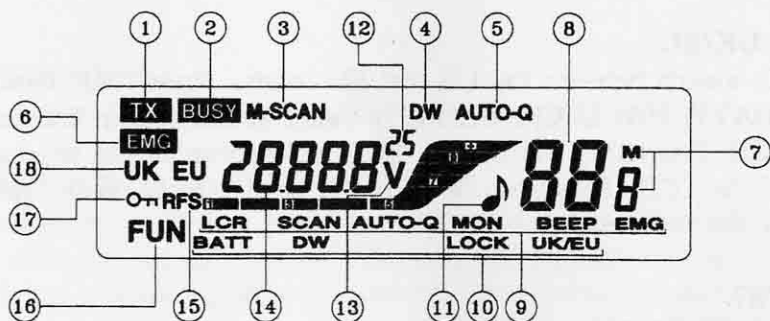

FIG DISPLAY

1. TX
2. BUSY
3. M-SCAN
4. DW
5. AUTO-Q
6. EMG

7.	M
8.	CHANNEL INDICATOR
9.	LCR, SCAN, AUTO-Q, MON, BEEP, EMG
10.	BATT, DW, LOCK, UK/EU
11.	♪ (Beep Sound)
12.	"25"
13.	"V"(Voltage)
14.	Frequency Indicator
15.	RFS
16.	FUN
17.	🔒 (LOCK)
18.	UK/EU

1. TX

When PTT on Mic pressed, TX shows in top left and RF shows to left of graduated graph showing set is transmitting.

2. BUSY

When channel is in use a busy sign shows; this also shows when setting squelch control.

3. M-SCAN

(1) SCAN

Indicates that the radio is in the "scan" mode, which works in conjunction with all 80 channels (40 in each band UK/EU).

(2) M-SCAN

Indicates that the radio is in the "memory-scan" mode, which means that the EM-27 will only scan the channels stored in the seven memory locations.

4. DW

Indicates that the "Dual Watch" feature has been activated.

5. AUTO-Q

Indicates that the "Auto-Q" feature has been activated.

6. EMG

Identifies that radio is in the emergency channel mode, either 9 or 19, but please note in the UK channel 19 is a calling channel, only channel 9 is to be used as emergency channel.

7. M

Indicates that a pre-set memory location has been selected, and the corresponding channel that is assigned to that Memory.

8. CHANNEL INDICATOR

Displays the channel number in which the radio is operating on.

9. LCR, SCAN, AUTO-Q, MON, BEEP, EMG

Indicates that the first function of each button from "M2" to "M7".

10. BATT, DW, LOCK, UK/EU

Indicates alternative functions for buttons "M2" to "M7".

11. B

Indicates that beep tone confirmation is activated.

12. "25"

Indicates the last two digits of relevant frequency of any of the 40 channels when the EM-27 is in UK channels mode.

13. "V"

Indicates that supplied D.C voltage

14. FREQUENCY INDICATOR

Displays the frequency of the corresponding channel, which the radio is operating on.

15. RFS

Your EM-27 incorporates a ten segment incoming signal and power output meter in the LCD. When receiving a signal, "S" is displayed on the LCD and the meter will indicate how strong the signal is. One or two segments will indicate a weak signal, while a very strong

signal will have 7 to 10 segments illuminated. When transmitting, the letter "TX" and "RF" will appear on the LCD. If the radio is operating, segments will appear on the LCD.

16. FUNCTION MODE

Indicates the "M1" button has been selected, which allows for operation of the other functions of each memory button. The "FUN" icon is illuminated constantly when the first function of each button is accessed. "FUN" is blinking, when the second function of each button is accessed.

17. (LOCK)

Indicates that the key lock feature has been activated.

18. UK/EU

Indicates that the transmission modulation mode UK OR EU.

FIG C. THE MULTI-FUNCTION MICROPHONE INFORMATION

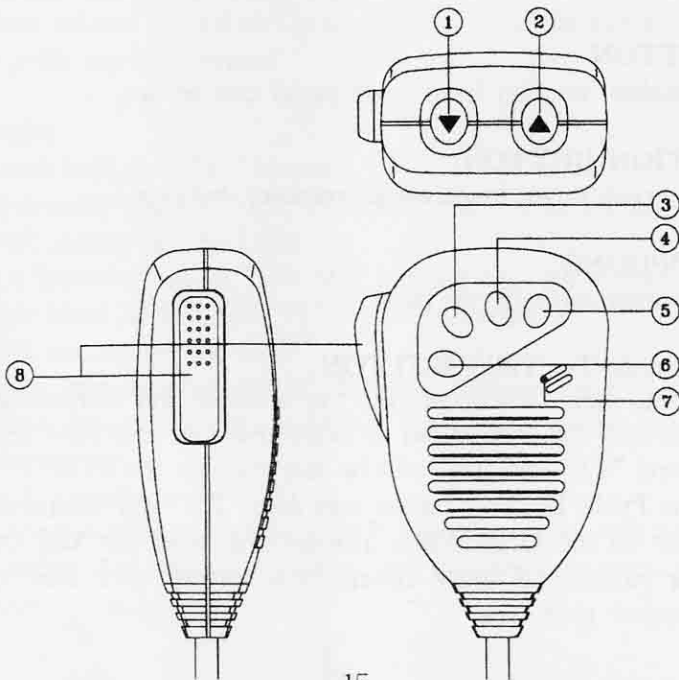

FIG	FUNCTION
1.	DOWN BUTTON
2.	UP BUTTON
3.	P1(USER DEFINE)
4.	P2(USER DEFINE)
5.	P3(USER DEFINE)
6.	FUNCTION BUTTON
7.	MICROPHONE
8.	PTT BUTTON

1. "▼"BUTTON

This button is used to change the channel number in descending order.

2. "▲"BUTTON

This button is used to change the channel number in ascending order.

3. P1 BUTTON

User definable function from front panel can be set.

4. P2 BUTTON

User definable function from front panel can be set.

5. P3 BUTTON

User definable function from front panel can be set.

6. FUNCTION BUTTON

Used to access other functions of memory buttons.

7. MICROPHONE

Actual microphone pick-up point.

8. PTT (Push-To-Talk) BUTTON

The Push-to-talk switch controls the receiver and transmitter. Press the switch and the transmitter is activated: you can now send a message and "TX" and "RF" will be displayed on the LCD. To receive, release the Push-To-Talk button and then "TX" will disappear and "S" will appear on the LCD. When transmitting, hold the MIC two inches from your mouth and speak clearly in a normal voice into the front of the speaker grill area.

■ SPECIAL FEATURES

1. RESET FUNCTION

If your EM-27 does not operate as shown in the user's manual or if you want to clear all stored functions, press and hold "M1" button and then press "M5" button.

2. BACK-UP FUNCTION

When the current is off or when your EM-27 is switched off, all user functions will be memorized as they were before the unit was switched off. When the C.B is switched on after long time (i.e. few days), please press the reset function.

3. DIM/BRT FUNCTION

This control is used to adjust the illumination of the LCD. To adjust backlighting of the LCD, press and hold "M1" button, and then press "M7" button.

4. LOW BATTERY

This feature gives a beep warning when the supply voltage drops below 9V.

5. SIX USERS DEFINED FUNCTIONS

This feature allows immediate access to the most frequently used functions with the microphone.

To activate;

- 1) Press and hold the "M1" button.
- 2) Simultaneously press "PWR (POWER)" button to switch on.
- 3) "P1" will appear on the LCD.
- 4) Select a function out of "M2-M7" buttons and press the button that you want to have at "P1" on the microphone.
- 5) "P2" will appear on the LCD.
- 6) Select the next function out of "M2-M7" buttons except the button you chose first and press the button that want to have at "P2" on the microphone.
- 7) "P3" will appear on the LCD.
- 8) Select the function out of "M2-M7" buttons except the buttons you chose before and press the button that you want to have at "P3" on the microphone.

- 9) "PP" will appear on the LCD.
- 10) Press "PTT" button to confirm your selection. Then LCD will return to normal operation. Now you can select the functions of the chosen buttons with the microphone.
- 11) Press the "F" button in the microphone, and then you can select the second function of each chosen button.
- 12) If you want to change the stored functions in the microphone, repeat the process described in "To access".

Even when the power is off; the stored functions on the microphone will be kept. If you reset your EM-27, you will get the factory set stored functions on the microphone, "P1-M2", "P2-M5" and "P3-M5".

NOTE : Function 6 UK/EU band cannot be programmed as one of the functions on the Microphone.

■ HOW TO INSTALL YOUR EM-27

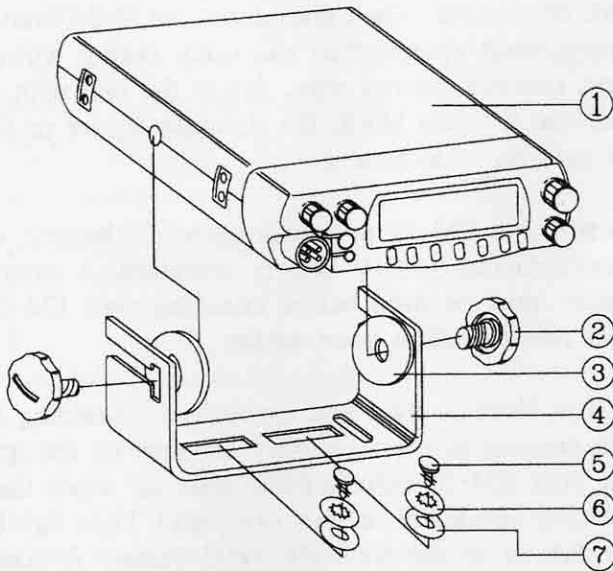

FIG

FUNCTION

- | | |
|----|-----------------------|
| 1. | Transceiver |
| 2. | Mounting bolt |
| 3. | Washer rubber |
| 4. | Set mounting bracket |
| 5. | Screw |
| 6. | Internal plain washer |
| 7. | Plain washer |

This transceiver may be installed in any 12 volt negative car or truck. Most vehicles use negative system, but some old models and some newer large trucks may have a positive ground.

Check the requirements for your vehicle before you begin installation.

Generally, you have a negative-ground system if the minus (-) battery terminal is connected to the motor block. Contact your dealer in the event you are unable to determine your vehicle's polarity system.

Power Wiring

If you have not determined whether your vehicle has a negative or positive ground, do so now. Then disconnect the leads from the battery to prevent short circuits that can occur during wiring. With negative ground, connect the red wire, this is the one with in-line fuse holder, to either the (a) fuse block, (b) cigarette lighter or (c) directly to the positive post on your battery.

NOTE : When fitting EM-27 in trucks with 24V battery, do not connect directly to 24V battery terminals. A suitable voltage reducer must be used before installing your EM-27, if in doubt please consult your dealer.

(Usefully, the fuse block is the most convenient connecting point. It is also possible to connect to the Accessory terminal on the ignition switch, so that your EM-27 automatically goes off when the ignition goes off, preventing accidental battery drainage.) Then tightly connect the black wire directly to the vehicle's metal frame. A good direct metal-to-metal ground is essential for optimum performance. Plug-in the power cord to the receptacle provided on the back of the transceiver.

Caution: Always ensure that you have observed the correct wiring connection procedure, if the wires are connected incorrectly (cross-wired) then it may result in **damaging your EM-27 CB.**

DAMAGE BY INCORRECT WIRING IS NOT COVERED BY WARRANTY.

CAR'S MOTOR BLOCK OR FIRE WALL GROUND

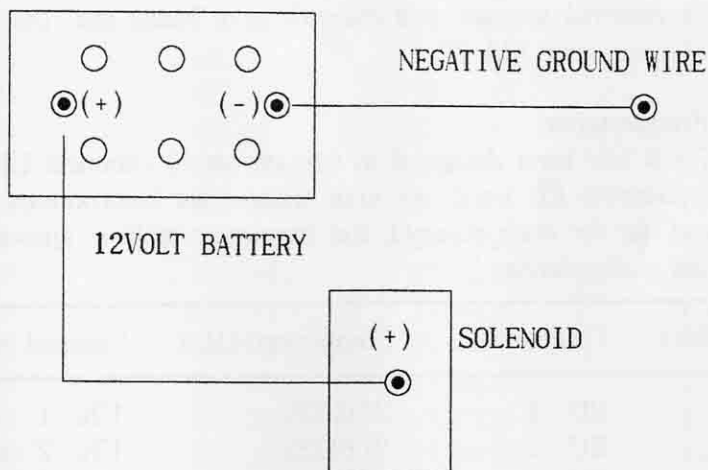

Mounting the main unit in the vehicle

1. Position the main unit between the set-mounting bracket in line with the mounting bolt. Set the angle for optimum operating comfort and accessibility.
2. Tighten the mounting bolt.
3. Make sure your antenna cable is connected to the rear antenna connector socket. Always make sure your antenna has been properly tuned in with a SWR meter, and that the PL259 connector on the end of 50ohm antenna lead is fitted correctly. If you don't have your antenna tuned in correctly, and you attempt to use your EM-27 CB, you may damage your CB. **IF YOU ARE UNSURE ABOUT THIS PLEASE CONSULT YOUR DEALER.**
4. After ensuring that a correctly tuned antenna is connected proceed to fit the multi-function microphone to the microphone socket. Never attempt to press the PTT button on your microphone to speak if the antenna lead is not connected to the EM-27 CB, as it may damage your EM-27 CB.

Connecting optional extension speaker.

Some users prefer to fit an extension speaker to their CB set, you may fit an optional extension speaker by connecting it to the rear of your EM-27 CB.

your EM-27 CB. Locate the "SPKR" socket on the main unit rear panel. Firmly insert the speaker jack plug into the socket. When connected, the external speaker will override and "blank out" the built-in speaker on your EM-27.

Operating Frequencies

Your EM-27 CB has been designed to operate on 40 channels UK band and 40 channels EU band. As your transceiver incorporates a frequency read out for each channel, the frequency table is shown below for your convenience.

Frequency(MHz)	Channel No.	Frequency(MHz)	Channel No.
26.965	EU 1	27.60125	UK 1
26.975	EU 2	27.61125	UK 2
26.985	EU 3	27.62125	UK 3
27.005	EU 4	27.63125	UK 4
27.015	EU 5	27.64125	UK 5
27.025	EU 6	27.65125	UK 6
27.035	EU 7	27.66125	UK 7
27.055	EU 8	27.67125	UK 8
27.065	EU 9	27.68125	UK 9
27.075	EU 10	27.69125	UK 10
27.085	EU 11	27.70125	UK 11
27.105	EU 12	27.71125	UK 12
27.115	EU 13	27.72125	UK 13
27.125	EU 14	27.73125	UK 14
27.135	EU 15	27.74125	UK 15
27.155	EU 16	27.75125	UK 16
27.165	EU 17	27.76125	UK 17
27.175	EU 18	27.77125	UK 18
27.185	EU 19	27.78125	UK 19
27.205	EU 20	27.79125	UK 20
27.215	EU 21	27.80125	UK 21
27.225	EU 22	27.81125	UK 22
27.255	EU 23	27.82125	UK 23
27.235	EU 24	27.83125	UK 24
27.245	EU 25	27.84125	UK 25

27.265	EU 26	27.85125	UK 26
27.275	EU 27	27.86125	UK 27
27.285	EU 28	27.87125	UK 28
27.295	EU 29	27.88125	UK 29
27.305	EU 30	27.89125	UK 30
27.315	EU 31	27.90125	UK 31
27.325	EU 32	27.91125	UK 32
27.335	EU 33	27.92125	UK 33
27.345	EU 34	27.93125	UK 34
27.355	EU 35	27.94125	UK 35
27.365	EU 36	27.95125	UK 36
27.375	EU 37	27.96125	UK 37
27.385	EU 38	27.97125	UK 38
27.395	EU 39	27.98125	UK 39
27.405	EU 40	27.99125	UK 40



R & TTE Approval Standards. This equipment is approved for use in the following EU countries. GB, IE.

It may also be used in other EU countries provided that all approval procedures according to the R & TTE Directive are followed.

In the event of any problems you should contact your equipment suppliers in the first instance.

SHARMAN MultiCOM LTD.

3 BURY NEW ROAD

MANCHESTER M8 8FW

TEL:0161-834 9571

FAX: 0161-835 3679