

19DX-IV

(SERVICE MANUAL)

SUBJECT	PAGE	ISSUE NO.	APPLICATION
Specification		AA	19DX-IV
Operating instructions		AA	19DX-IV
Theory of Operation		AA	19DX-IV
Troubleshooting Hints		AA	19DX-IV
Alignment Point		AA	19DX-IV
Test Equipment Setup and Alignment instructions		AA	19DX-IV
Block Diagram		AA	19DX-IV
Schematic Diagram		AA	19DX-IV
Semiconductor Lead Identification And IC Internal Connections		AA	19DX-IV
Main PCB Board (TOP View)		AA	19DX-IV
Main PCB Board (Bottom View)		AA	19DX-IV
Voltage Chart		AA	19DX-IV
Parts List		AA	19DX-IV
Exploded View		AA	19DX-IV
Exploded View Parts List		AA	19DX-IV
Issue No. & Date	AA (2005/6/7)		

SPECIFICATION

A. GENERAL

RECEIVER

- 1) DISPLAY : 40 CHANNELS AND OTHER FUNCTIONS INDICATION
- 2) FREQUENCY RANGE : 26.965 TO 27.405 [MHz]
- 3) FREQUENCY RESPONSE : 300 TO 2,500 [Hz]
- 4) POWER SOURCE : 13.8 [V] DC
- 5) AUDIO OUTPUT LOAD : 8 [OHM] RESISTIVE
- 6) AUDIO OUTPUT : 5 [W] (OR MORE)
- 7) SQUELCH : ADJUSTABLE FROM 250 [uV] TO 4000 [uV]
- 8) SENSITIVITY : 10 dB [SINAD] UNDER 1.0 [uV] RF SIGNAL OR LESS.
(WITH CCITT FILTER)
- 9) INTERMEDIATE FREQUENCY : 1st IF - 10.7 [MHz]
2nd IF - 450 [KHz]

TRANSMITTER

- 1) CARRIER POWER : 4 [W]
- 2) CURRENT DRAIN (13.8 [V] SUPPLY VOLTAGE)
900 [mA] (NO MODULATION)
1,200 [mA] (MAX MODULATION)
- 3) MODULATION CAPABILITIES : AM +/- 90 %
- 4) SPURIOUS RADIATION : LESS 60 dB
- 5) ANTENNA IMPEDANCE : 50 [OHM]
- 6) FREQUENCY TOLERANCE : 0.002 [%]

B. TECHNICAL DESCRIPTION

1. GENERAL

MODEL 19DX IV CB IS AN MOBILE AM RADIO TRANSCEIVER
FOR USE OF THE CITIZENS BAND RADIO.

et FRONT PANEL CONTROLS

- (1) LCD (CHANNEL)
- (2) RX/TX SIGNAL LEVEL INDICATOR
- (3) VOLUME CONTROL(WITH ON/OFF SWITCH)
- (4) SQUELCH CONTROL
- (5) RF GAIN CONTROL
- (6) UP/DN ROTARY SWITCH
- (7) CH 9/19 S/W
- (8) CB/PA S/W
- (9) MICROPHONE SOCKET

et ASSESSABLE CONNECTORS

- a. ANTENNA SOCKET
- b. EXTERNAL BATTERY WIRE (battery+(-))
- c. EXTERNAL CONNECTOR(SPEAKER OUTPUT)
- d. EXTERNAL CONNECTOR(PA OUTPUT)

2. TYPE OF EMISSION : AM(A3E)

3. FREQUENCY RANGE

STANDARD 40 CB CHANNELS
26.965 [MHz] (1CH)- 27.405 [MHZ] (40CH)

4. RF POWER OUTPUT : 4.0 [W]

5. DC INPUT VOLTAGE AND CURRENT WITH 13.2 [V] DC INPUT TO POWER AMP

TRANSMITTER POWER AMP -----

VOLTAGE 12.6 V

CURRENT 727 mV

TRANSMITTER DRIVER AMP -----

VOLTAGE 12.6 V

CURRENT 120 mA

6. RECEIVER IF AND LOCAL OSCILLATOR FREQUENCIES .

FIRST IF -----	10.7 [MHz]
SECOND IF -----	450 [KHz]
FIRST LOCAL OSCILLATOR -----	37.665 [MHz] Above receiving frequencies
SECOND LOCAL OSCILLATOR -----	10.250 [MHz]

DESCRIPTION OF FREQUENCY DETERMINING AND STABILIZING CIRCUITRY

1 INTRODUCTION

THE FREQUENCY FOR TRANSMITTER AND RECEIVER FIRST LOCAL FREQUENCIES ARE ALL DERIVED FROM A SINGLE 10.250 [MHz] CRYSTAL BY MEANS OF A PHASE LOCKED LOOP.

THE FIRST LOCAL OSCILLATOR FREQUENCIES ARE 37.665 [MHz] (CH.1) TO 38.105 [MHz] (CH.40).

THE SECOND LOCAL OSCILLATOR FREQUENCY IS FIXED AT 10.250 [MHz] TO GENERATE SECOND IF 450 [KHz].

DURING TRANSMIT, THE VCO OF PLL OPERATES 26.965 [MHz] (CH.1) TO 27.405 [MHz] (CH.40)

THE VCO OPERATING FREQUENCY FOR THE RECEIVER IS 37.665 [MHz] (CH.1) TO 38.105 [MHz](CH.40) AS THE FIRST LOCAL OSCILLATOR, AND INJECTED THROUGH BUFFER AMP QL3 TO THE FIRST MIXER QR3.

2 BASIC SYNTHESIS SCHEME

THE CRYSTAL FREQUENCY (10.250 [MHz]) IS DIVIDED BY 2050 TIMES TO MAKE 5.0[KHz], WHICH IS FED TO ONE SIDE OF THE PHASE DETECTOR.

THE VCO OUTPUT IS DIVIDED BY A PROGRAMMABLE DIVIDER, AND FED TO OTHER SIDE OF THE PHASE DETECTOR.

THE FEEDBACK LOOP, PIN 3 OF THE IC5 IS CLOSED BY PASSING THE PHASE DETECTOR OUTPUT THROUGH AN ACTIVE LOW PASS FILTER AND USING THE OUTPUT TO CONTROL THE VCO FREQUENCY THROUGH VARICAP DIODE DL1.

UNDER LOCKED CONDITIONS, BOTH OF PHASE DETECTOR INPUT SIGNAL MUST BE IDENTICAL AT 5.0 [KHz].

THE VCO FREQUENCY IS GIVEN BY:

$$F_{VCO} / N = 0.0050 \text{ MHz} \quad \text{OR} \quad F_{VCO} = 0.0050 * N \text{ [MHz]}$$

SINCE "N" IS AN INTEGER, THE VCO FREQUENCY CAN BE STEPPED UP WITH IN 5.0 [KHz] INCREMENTS.

BY SUITABLE CHOICE OF N THE DESIRED OUTPUT FREQUENCY CAN BE OBTAINED.

	CHANNEL 1		CHANNEL 40	
	N	FVCO	N	FVCO
TRANSMIT	5393	26.965	5481	27.405
RECEIVE	7533	37.665	7621	38.105

(SEE TABLE 1 FOR OTHER CHANNELS)

SINCE ALL FREQUENCIES ARE OBTAINED FROM THE CRYSTAL CONTROL PLL OSCILLATOR. ALL OUTPUTS ARE COHERENT WITH THE CRYSTAL OSCILLATOR FREQUENCY AND MAINTAINING THE SAME PARENTAGE ACCURACY.

3 DETAILED DESCRIPTION

er1 INTRODUCTION

THE SYNTHESIZER IS IMPLEMENTED WITH THE FOLLOWING COMPONENTS: PLL IC (IC5)

X-TAL (X 2)

VCO, VARICAP DIODE (DL1)

IC5 IS A CONTROL PLL IC.

THE QL2, LV1, CL22, CL21, CL20, CL16, VARICAP DIODE DL1 ARE CLAPP OSCILLATOR CIRCUIT TO OPERATE AS A VCO.

DL3 IS A SWITCHING DIODE TO CONNECT OR DISCONNECT THE TUNING COIL IN THE VCO OSCILLATOR TANK CIRCUIT FOR TRANSMITTER OR RECEIVER.

QL1, QL3 WORKS AS A BUFFER AMP FOR RX LOCAL FREQUENCY (37 [MHz]) AND TX CARRIER GENERATING FREQUENCIES (26 [MHz])

er2 REFERENCE FREQUENCIES

THE CRYSTAL, X 2 (10.250 [MHz]) AND OTHER COMPONENTS AROUND PIN 10 AND 11 OF IC5 CAN

MAKE A REFERENCE FREQUENCY OSCILLATOR WITH INTERNAL AMPLIFIER.

er3 VCO

QL2 AND SURROUNDING PARTS CONSIST OF A CLAPP OSCILLATOR WORKS AS A VCO .

WITH APPROPRIATE CONTROL VOLTAGE ON DL1 THE VCO CAN BE OSCILLATE OVER THE REQUIRED RANGE OF 26.965 [MHz] TO 38.105 [MHz].

er4 PROGRAMMABLE DIVIDER AND ITS CONTROL

THE PROGRAMMABLE INPUTS FOR EACH CHANNELS ARE SETTED THE INSIDE OF THE IC.

EACH INPUT SIGNAL TO CONTROL THE PLL IC IS DONE WITH THE PROVIDED UP/DN SWITCH

FOR EACH KEY INPUT, AN INTERNAL CODE CONVERT ERROM PROVIDES THE APROPRIATE BINARY CONTROL TO THE PROGRAMMABLE DIVIDER FOR THAT CHANNEL.

SINCE THE BINARY NUMBER NECESSARY TO CHANGE DURING TRANSMIT AND RECEIVE, AN ADDITIONAL ACTION IS REQUIRED AT PIN 10 OF IC4 TO RECOGNIZE THE STATUS IS TX OR RX.

DURING TRANSMIT, PUSHING TALK(PTT) SWITCH MAKES PIN 10 GROUNDS. PLL IC WORKS UNDER TRANSMIT STATUS.

THE PROGRAMMABLE DIVIDER IS FED TO THE PHASE DETECTOR TO COMPARE WITH THE 5.0 [KHz] REFERENCE FREQUENCY INSIDE OF THE IC5. SEE TABLE 1 FOR ACTUAL INPUT AND DIVIDE RATIO ON ALL CHANNELS.

er5 PHASE DETECTOR AND VCO CONTROL

THE PHASE DETECTOR IS A DIGITAL PHASE COMPARATOR WHICH COMPARES THE PHASE OF THE REFERENCE SIGNAL WITH PROGRAMMABLE DIVIDER OUTPUT SQUARE WAVES AND DEVELOPS A SERIES OF PULSES WHOSE DC LEVEL DEPENDS ON THE PHASE ERROR OF EACH SIGNAL.

THE PHASE DETECTOR PULSE OUTPUT IS FED TO AN ACTIVE LOW PASS FILTER AND RC LOW PASS FILTER OUTPUT SIGNAL OF IC4 IS FILTERED AND FED TO VARICAP DL1 CONTROL THE VCO FREQUENCY.

er6 TRANSMIT/RECEIVE, BUFFER AMP

OUTPUT SIGNAL OF QL2 IS FED INTO BUFFER AMP QL3 TO INCREASE THE STRENGTH OF TX CARRIER FREQUENCY AND 1ST LOCAL FREQUENCIES.

er7 TRANSMIT BUFFER AMP

THE OUTPUT SIGNAL OF QL3 GOES TO AN AMPLIFIER WITH TUNING CIRCUIT QT1, LT1, WITH DOUBLE INCOMING 26 MHz SIGNALS.

er8 SWITCHING OF TUNING COIL IN VCO OSCILLATOR CIRCUIT

THE VCO CIRCUIT MUST TURN WITH A WIDE RANGE OF FREQUENCIES 26.965 [MHz]-27.405 [MHz] FOR TRANSMITTER AND 37.665 [MHz]-38.105 [MHz] FOR RECEIVER. TO COMPLY ABOVE RANGE OF VCO, THE TUNING INDUCTANCE SHOULD SWITCH FOR TRANSMISSION OR RECEPTION.

THE TUNING CIRCUIT CONSISTS OF RT9, CB7, RT15, DL3, CL5, L02.

WHEN THE VCO IS WORKING AS A RECEIVER, DL3 BECOMES TURN ON TO GROUND.

SO CL5 AND DL3 MAKES TUNING FUNCTION. WHEN TRANSMITTING, DL3 BECOMES OFF.

SO CL5 DISCONNECTS TO LV1 AND THE SERISE INDUCTANCE L02 MAKES TURNING FUNCTION.

er9 RECEIVER LOCAL OSCILLATOR OUTPUTS

FIRST MIXER:

THE OUTPUT SIGNAL OF QL3 BUFFER AMP IS INJECTED TO THE SOURCES OF 1ST MIXER

QR3 IN THE 1ST IF MIXER SECTION

SECOND MIXER:

THE OUTPUT OF 10.250 [MHz] OSCILLATOR CIRCUIT WITH X2 IS INJECTED INTO SECOND MIXER QR4 IN THE 2nd IF MIXER SECTION.

INCOMING IF SIGNAL AND 10.250 [MHz] SIGNAL ARE MIXED ON THE QR4 TO EXTRACT 2ND IF SIGNAL 450 [KHz].

IF AMP AND DETECTOR:

THE OUTPUT OF 450 KHz 2ND IF GOES TO IF AMP QR5, QR6 THEN DETECT THE OUTPUT SIGNAL BY DR3.

4 FREQUENCY STABILITY

LET: F_o = CRYSTAL OSCILLATOR FREQUENCY

F_r = PHASE DETECTOR REFERENCE FREQUENCY

F_{vco} = VCO FREQUENCY

F_t = TRANSMIT FREQUENCY

THEN: $F_r = F_o / 1800$

AND UNDER LOCKED CONDITIONS : $F_r = F_{vco} / N$

“N” IS THE PROGRAMMABLE DIVIDER DIVIDE RATIO.

THEN: $F_{vco} = N * F_r$

FROM WITCH IT CAN BE SEEN, THE PERCENTAGE ERROR IN F_t IS THE SAME AS THE PERCENTAGE ERROR IN F_o .

THE STABILITY OF THE CRYSTAL OSCILLATOR IS DETERMINED PRIMARILY BY THE CRYSTAL ITSELF AND HAVING LESSER DEVIATION BY THE ACTIVE AND PASSIVE COMPONENTS OF THE OSCILLATOR.

THE CHOICE OF CRYSTAL AND COMPONENTS IS SUCH THAT THE REQUIRED STABILITY IS MAINTAINED OVER THE REQUIRED VOLTAGE AND TEMPERATURE RANGE.

5 DESCRIPTIONS OF OTHER CIRCUITS

TRANSMITTER

*et*a. RF AMPLIFICATION

THE OUTPUT OF BUFFER AMP QT1 IS FED THOUGH TUNING IFT LT1 AND THE BASE OF PRE DRIVER AMP QT2.

THE OUTPUT IS THEN SUPPLIED THROUGH TUNING CIRCUIT CT10 TO RF DRIVER AMP QT3.

THE OUTPUT OF QT3 IS SUPPLIED WITH TUNING CIRCUIT LT4, CT14, AND LT5,RT14 GOES TO THE BASE OF FINAL RF AMP QT4.

THE OUTPUT OF QT4 IS SUPPLIED TO THE ANTENNA THROUGH L-C TUNING CIRCUIT

*et*b. CIRCUIT FOR SUPPRESSION OF SPURIOUS RADIATION

THE TUNING CIRCUIT BETWEEN THE OUTPUT OF FINAL AMP QT4 AND ANTE, 4-STAGE “LPF” NETWORK CT21,LT11,CT25,LT12,CT26,LT13,CT30,LT7,LT14 SERVES AS A SPURIOUS RADIATION SUPPRESSOR. THIS NETWORK ALSO SERVES TO MATCH IMPEDANCE BETWEEN TX POWER AMP QT4 AND THE ANTENNA.

*et*d. MODULATION CONTROL

MODULATION SIGNALS ARE FILTERED WITH RC NETWORK AND GOES TO THE AUDIO POWER AMP IC1 TO MAKE NOMINAL SIGNAL LEVEL TO ACHIEVE WANTED MODULATION.

TO CONTROL INCOMING AUDIO SIGNAL, DIODE DM1 AND CORRESPONDING ALC CIRCUIT CONTROLS WITH PROPORTIONAL TO SAMPLED AUDIO OUTPUT LEVEL.

ADJUST RVM1 SHALL NOT EXCEED +/- 90[%] MODULATION UNDER 1[KHz] AF 1.5 V_{rms} LEVEL INPUT.

etc. RECEIVER

CB RECEIVER IS DUAL CONVERSION SUPER-HETERODYNE TYPE WITH THE FIRST IF 10.7 [MHz] AND THE SECOND IF 450[KHz].

RECEIVER IS SEPERATED TWO BLOCKS, 1ST IF SECTION AND 2ND IF SECTION. THE PLL SYNTHESIZER SUPPLIES THE FIRST LOCAL FREQUENCY 37.665-38.105 [MHz].

THE PROVIDED FIRST LOCAL FREQUENCY QR3 MIXS THE INCOMING RF SIGNAL TO GENERATE THE FIRST IF SIGNAL.

THE MIXED SIGNALS ARE FILTERED WITH THE CF1 (10.7 MHz) CERAMIC FILTER AND OTHER TUNING CIRCUITS.

THE OUTPUT SIGNAL OF MIXER FILTERED WITH CF2 (450 [KHz] CERAMIC FILTER).

THE 450 [KHz] SIGNAL FROM THE 2ND IF FILTER WAS AMPLIFIED .

AFTER AMPLIFICATION THE SIGNAL IS FED TO IF AMP (QR5,QR6) AND THEN DETECT THE AF SIGNAL BY DR3

G. TRANSMITTER TUNE UP PROCEDURE

A. PRELIMINARY SYNTHESIZER ALIGNMENT

CONNECT RF POWER METER OR 50 [OHM] DUMMY LOAD TO THE ANTENNA SOCKET.

THE RF SIGNALS WERE LOW ENOUGH DURING TX START-UP PROCEDURE, OUTPUT SIGNAL CAN INTERFERE OTHER EQUIPMENT IN THE TX OPERATIONS.

SELECT THE OPERATING CHANNEL ON CH 1.

CONNECT DC VOLTMETER BETWEEN GROUND AND CL10 WHICH IS CONNECTED RL11 AND RL13

MAKE THE SET UNDER RX MODE. TUNE THE VCO OSCILLATION ADJUSTING IFT LV1 TO OBTAIN 2.0 [V] READING OF DC VOLTMETER. CHECK THE VOLTAGE OF CHANNEL 40 WHETHER THE READING IS IN BETWEEN 3.0 TO 4.0 [V] DC UNDER RX MODE.

REMOVE DC VOLTMETER.

B. FINAL ALIGNMENT

1.RX ALIGNMENT

CONNECT THE PROBE OF RF SIGNAL MEASURING EQUIPMENT BETWEEN GROUND AND

ANNTENA POINT.

SET THE SINAD OF SSG TO -107DBM AND THEN ADJUST LR1,LR2,LR4,LR5 FOR MAXIMUM READING ON THE EQUIPMENT.

2. TX ALIGNMENT

CONNECT THE RF SIGNAL MEASURING EQUIPMENT BETWEEN GROUND AND BASE OF TRANSISTOR QT3

TRANSMIT ON CHANNEL 19

ADJUST LT1 FOR MAXIMUM READING ON THE EQUIPMENT .

REPEAT IF NEEDED.

REMOVE RF PROBE.

3. REPEAT STEP 1 AND 2 IF NEEDED.

4. OUTPUT POWER READING ON RF POWER METER SHOULD BE FROM 3.8 TO 4.0 [W]

IF POWER EXCEEDS 4.0 [W] .

C. FINAL CHECK

TRANSMIT ON ALL 40 CHANNELS

1. OUTPUT POWER SHOULD BE FROM 3.6 TO 4.0 [W].

2. FREQUENCY SHOULD BE WITH IN +/- 100 [Hz] OF ASSIGNED CHANNEL CENTER FREQUENCY.

3. STRENGTH OF SPURIOUS SIGNALS AS OBSERVED ON SPECTRUM ANALYZER SHOULD BE LESSER [60] THAN THE TRANSMITTING SIGNAL.

TROUBLESHOOTING HINTS

Symptom	Probable Cause	Remedy
Unit does not work At all	<ul style="list-style-type: none"> ● Defective components of X4. ● Disconnect DC power Terminals 	<ul style="list-style-type: none"> ● Replace defective Component(s) ● Replace
No out from Speaker at all	<ul style="list-style-type: none"> ● Defective external speaker line. ● Measure all the voltage of IC1. ● Defective internal speaker. 	<ul style="list-style-type: none"> ● Repair or replace ● Repair or replace ● Replace
No noise on Speaker	<ul style="list-style-type: none"> ● Measure all the voltage of RF circuit Component ● Defective squelch circuit components Compare with the voltage chart. 	<ul style="list-style-type: none"> ● Replace defective Component(s)
No modulation	<ul style="list-style-type: none"> ● Defective microphone. ● Defective IC1(KIA7217AP) and its related circuit 	<ul style="list-style-type: none"> ● Replace ● Replace
LCD does not work	<ul style="list-style-type: none"> ● Measure all the voltage of X4, IC4 	<ul style="list-style-type: none"> ● Replace defective Component(s)

ALIGNMENT POINTS

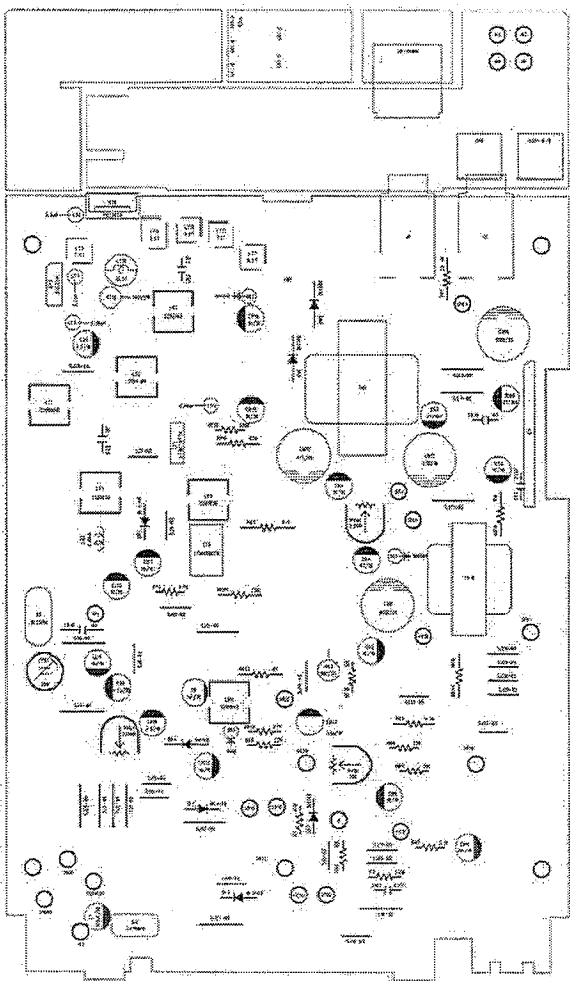

TOP VIEW -

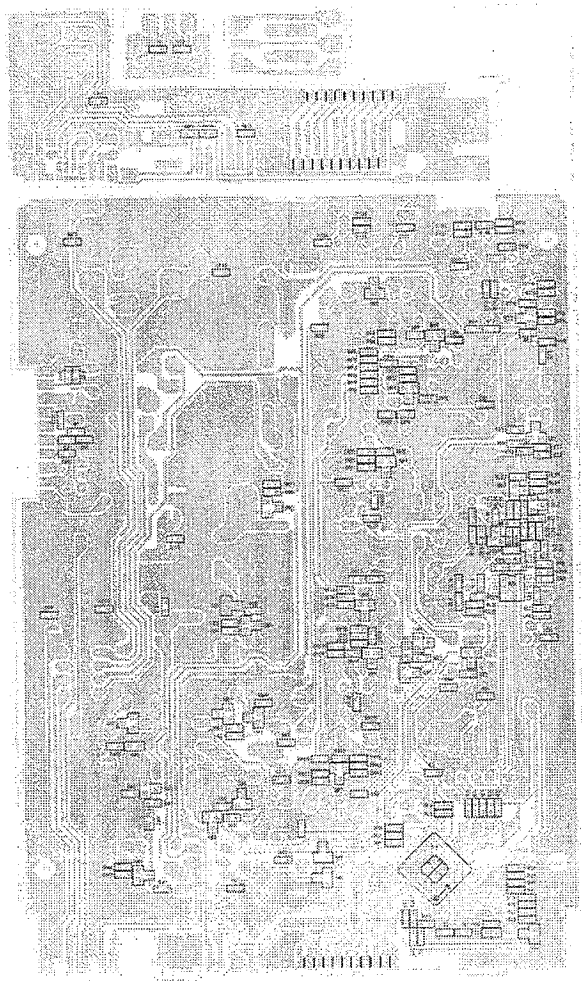

- BOTTOM VIEW -

TEST EQUIPMENT SETUP AND ALIGNMENT INSTRUCTIONS

ALIGNMENT PROCEDURE

Step	Setting	Connection	Adjuster	Adjuster for
1	RX VCO voltage adjustment Frequency: CH1 (26.965MHz) MIC: Receive Function: None Volume: Optional Squelch: Optional	DC voltmeter to VCO Test point (Figure 1)	LV1	2.0 V DC
2	TX VCO voltage Frequency: CH1 (26.965MHz) MIC: Transmit (Unmodulated) Function: None Volume: Optional Squelch: Optional	Dc voltmeter VCO Test point1 (Figure 1)	NO Adjust	Confirm the VCO Voltage Range 3.0 ±0.5V DC
3	Frequency adjustment Frequency: CH1 (26.965MHz) MIC : Transmit (Unmodulated) Function: None Volume: Optional Squelch: Optional	Antenna to frequency Counter, Through Attenuator (Figure 2)	CTX1	± 300 Hz

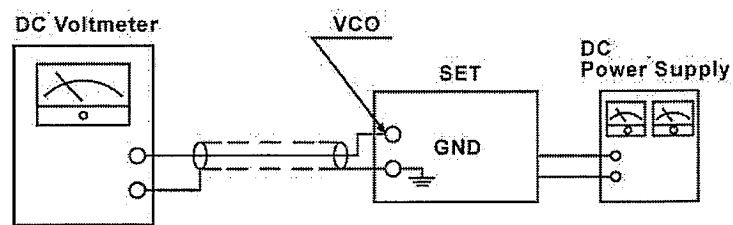

FIGURE 1

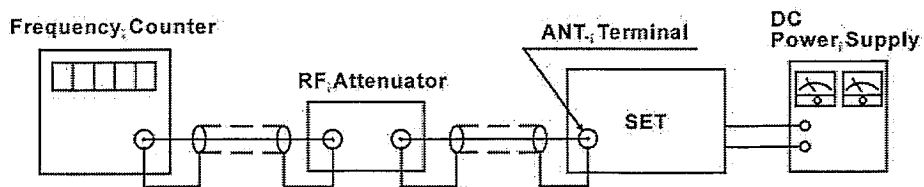

FIGURE 2

TRANSMITTER SECTION

Test Equipment Required

- RF power meter (RF SSVM)
- 50 ohms dummy load (non-inductive)
- RF attenuator (50 ohms non-inductive)
- Oscilloscope
- Audio generator
- DC power supply
- Spectrum analyzer
- Frequency counter
- Coupler
- Modulation meter (FM)

ALIGNMENT PROCEDURE

Step	Setting	Connection	Adjuster	Adjuster for
1	MODULATION adjustment Frequency : CH1 (26.965MHz) Volume: Optional Squelch: Optional	Connection the audio generator (Set to 1 KHz) to the microphone jack. Connect the modulation meter through the RF attenuator to the ANT jack. Adjust the audio signal level to Obtain-by 50% modulation. When you increase the audio Signal by 20 dB, the modulation Should not exceed 95% Deviation (Figure 3)	RVM1	90% MOD.
2	RF power confirm Frequency : CH1 (26.965MHz) NO MODULATION MIC: Transmit	Connect the power meter to the ANT jack.	LT1	To adjust MAX Power.

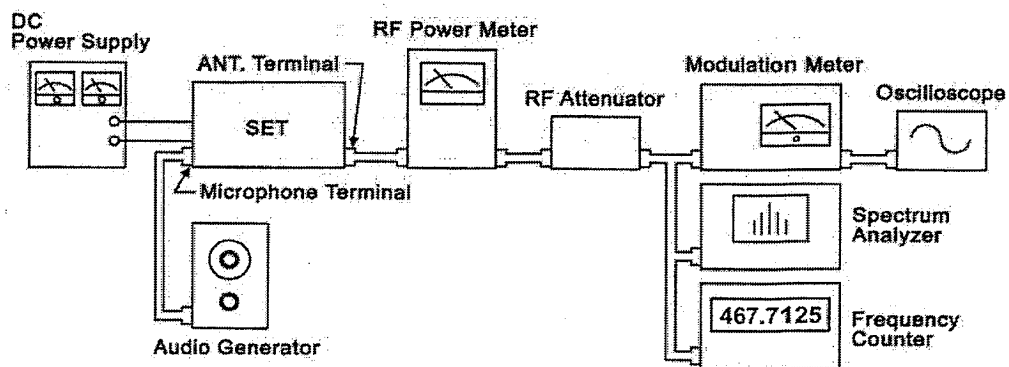

FIGURE 3

RECEIVER SECTION

Test Equipment Required

- Standard signal generator (SSG)
- AC Level meter
- Distortion meter
- DC power supply
- SINAD meter

Alignment Procedure

Step	Setting	Connection
1	RX sensitivity and squelch adjustment Frequency: CH1 (26.965MHz) MIC : Receive Function: None Volume: center position SSG: Audio 1 KHz Modulation 30%	Connect the standard signal Generator to the EXT-ANT JACK. Connect the AC volts level meter, distortion meter and SINAD meter across the EXT speaker jack with an 8 ohm dummy load. (Figure 4)

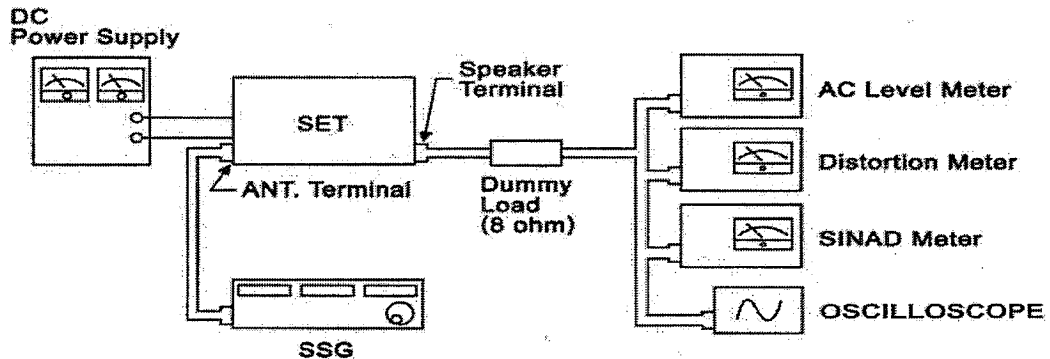

FIGURE 4

1. Power Supply Voltage

The proper voltage for testing is 13.8 VDC.

2. Receiver Alignment

- A. Connect an RF signal generator or Communications Service Monitor to the antenna connector.
- B. Connect a SINAD meter and oscilloscope across the speaker terminals.
- C. Set the output level of the RF signal generator for -47 dBm. The generator should be set for +/- 30% modulation of a 1 KHz tone.
- D. Set the audio output center. by adjusting volume. .
- E. Set the max audio by adjust LR4,LR5
- F. Set the max sensitivity by adjust LR1,2.
- G. With SSG-47DBM, Adjust the squelch SEMI-VR (RVQ1) in order to be squelch on Air
During adjusting, squelch volume should be at maximum (VR2-A)

CHANNEL FREQUENCY TABLE

FREQUENCY CHART

CHANNEL	FREQUENCY (MHz)	CHANNEL	FREQUENCY (MHz)
1	26.965	21	27.215
2	26.975	22	27.225
3	26.985	23	27.255
4	27.005	24	27.235
5	27.015	25	27.245
6	27.025	26	27.265
7	27.035	27	27.275
8	27.045	28	27.285
9	27.055	29	27.295
10	27.065	30	27.305
11	27.075	31	27.315
12	27.085	32	27.325
13	27.105	33	27.335
14	27.115	34	27.345
15	27.125	35	27.355
16	27.135	36	27.365
17	27.155	37	27.375
18	27.175	38	27.385
19	27.185	39	27.395
20	27.205	40	27.405

BLOCK DIAGRAM

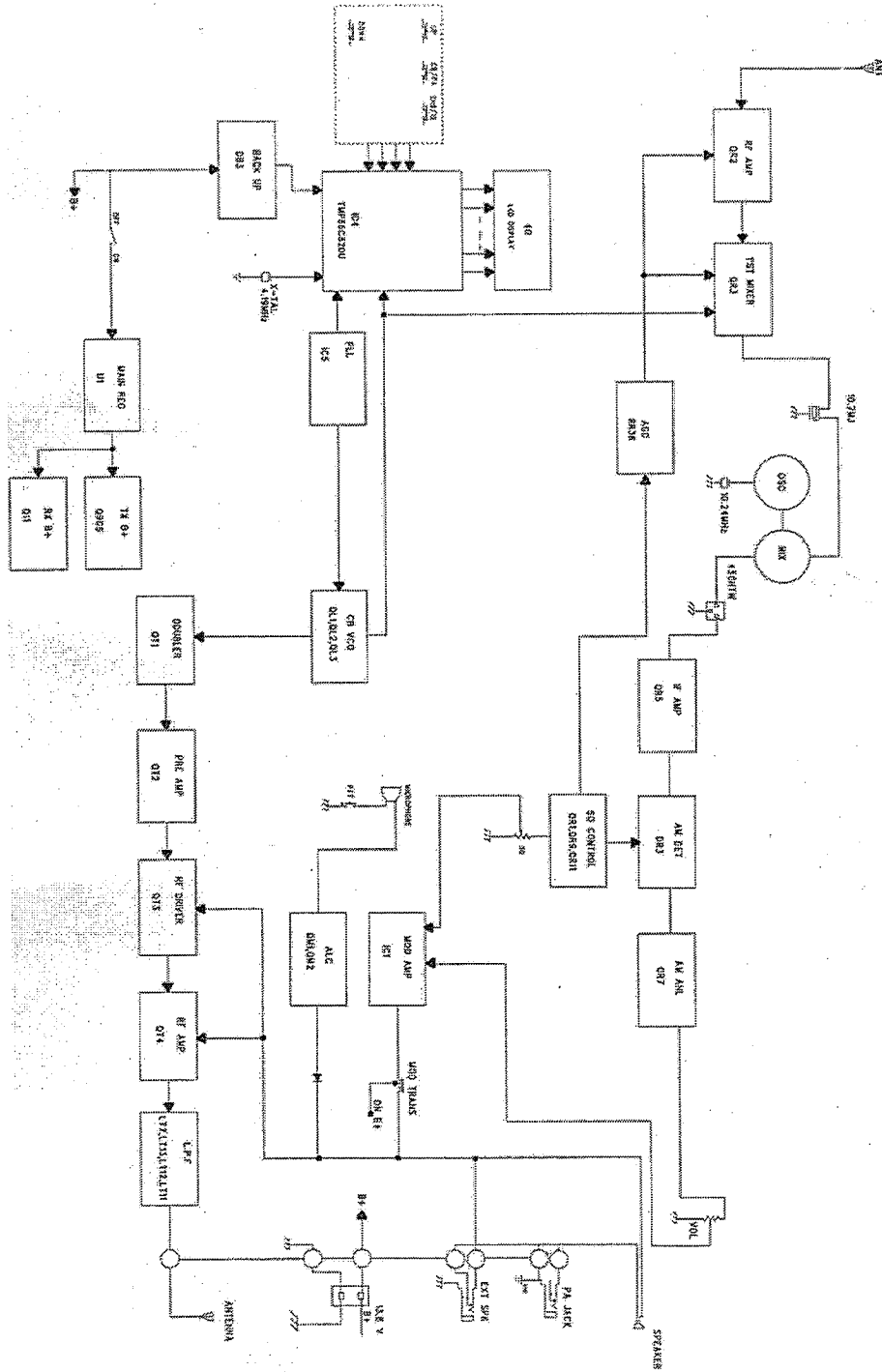

SEMICONDUCTOR LEAD IDENTIFICATION AND IC INTERNAL CONNECTIONS

IC

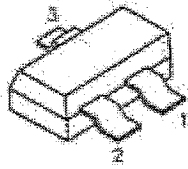

TK71550

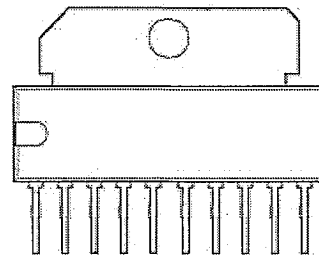
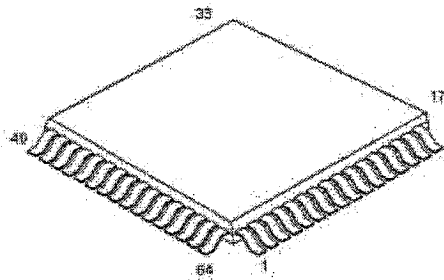
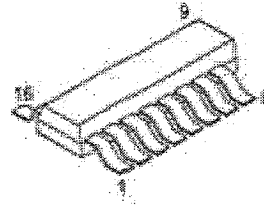

TRANSISTOR

- KTC3875
- KTA1504
- KRC104S
- KRA105S
- KTC3880
- KRA226S

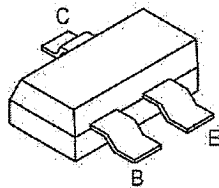

DIODES

KDS181S

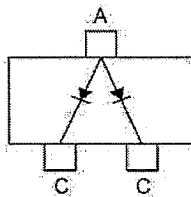

KDS184S

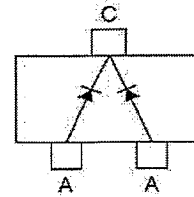

KDS114E

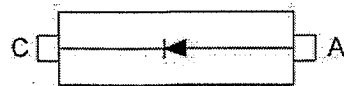
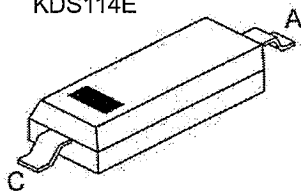

IC INTERNAL BLOCK DIAGRAM

▪ TMP87CH21

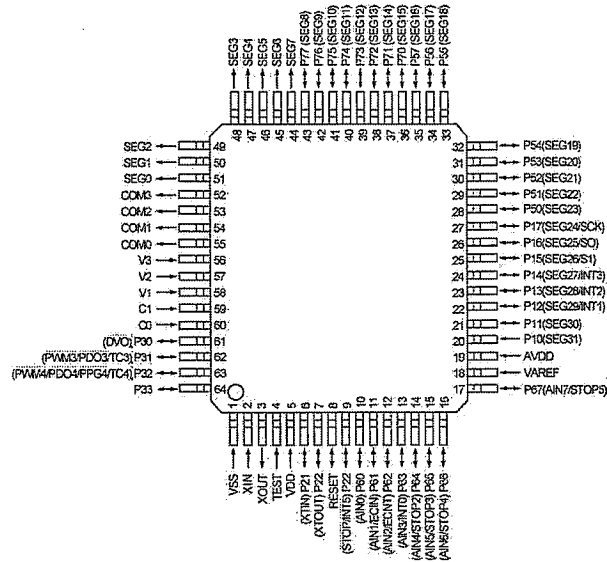

▪ BLOCK DIAGRAM

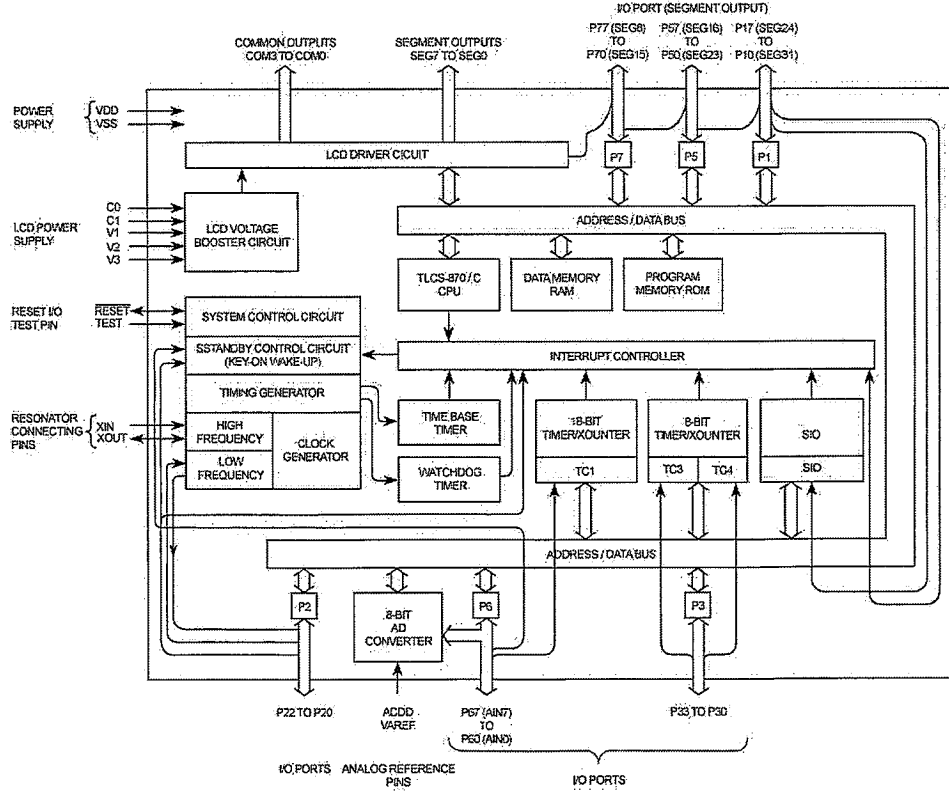

▪ IC4

TB31202FN/KB8825B

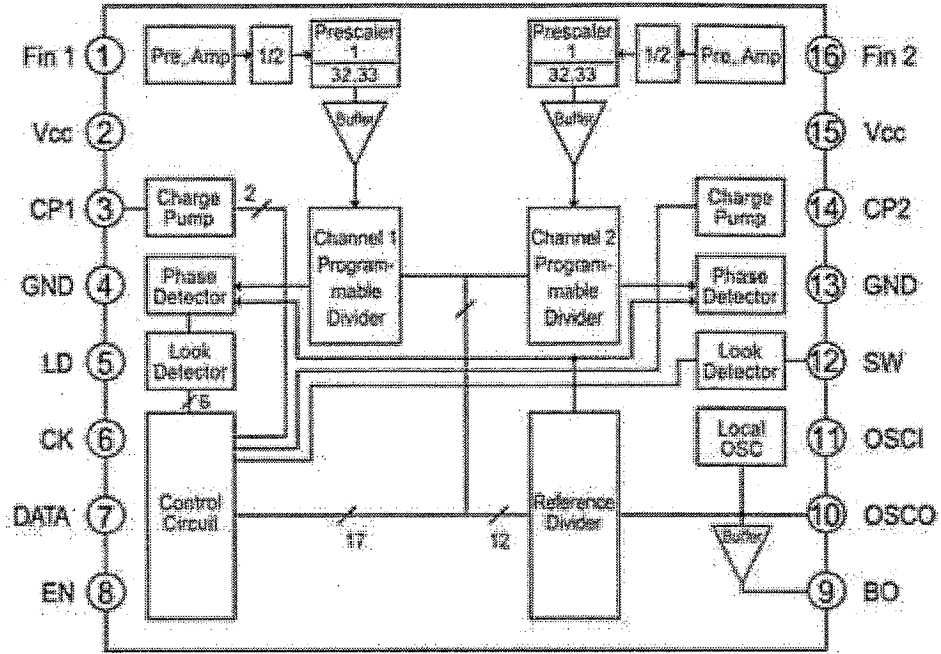

▪ IC

KIA7217AP

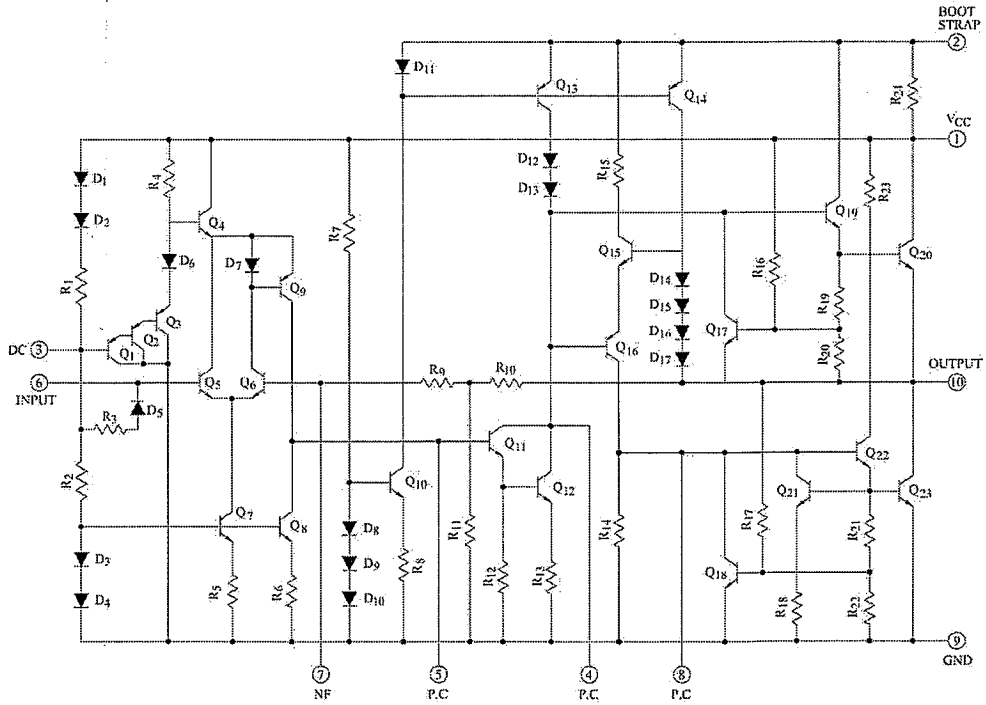

MAIN PCB BOARD

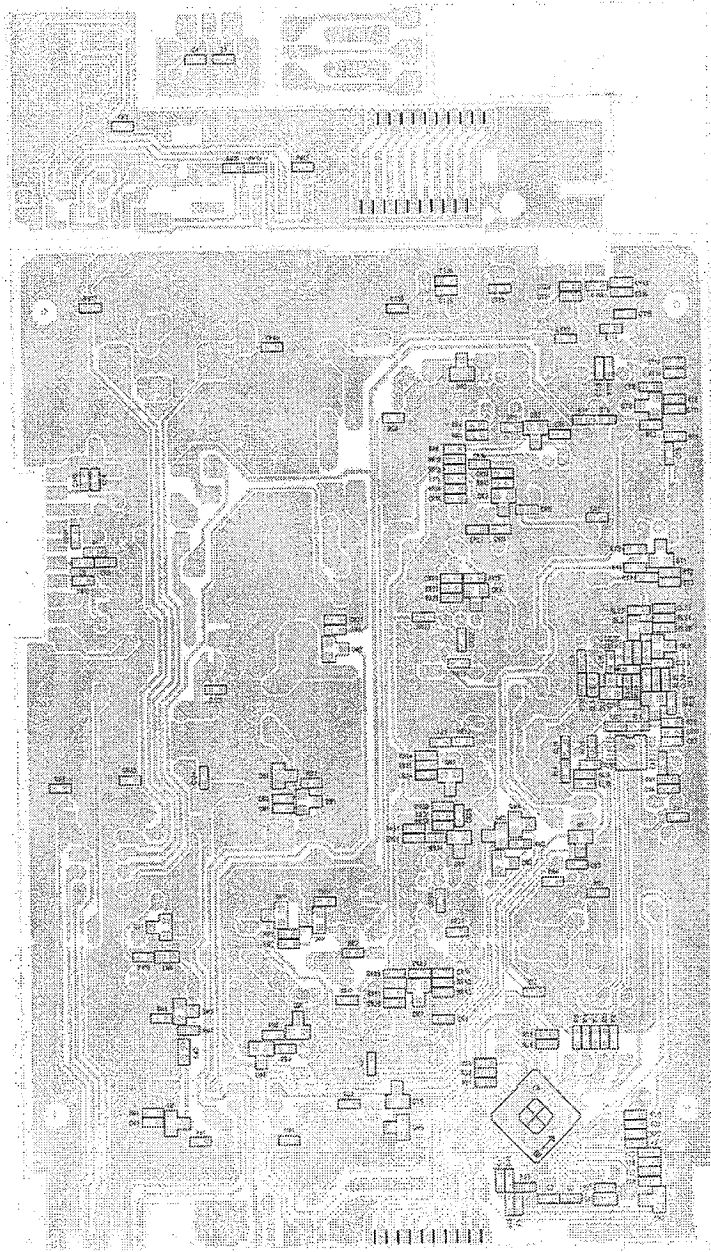

BOTTOM VIEW

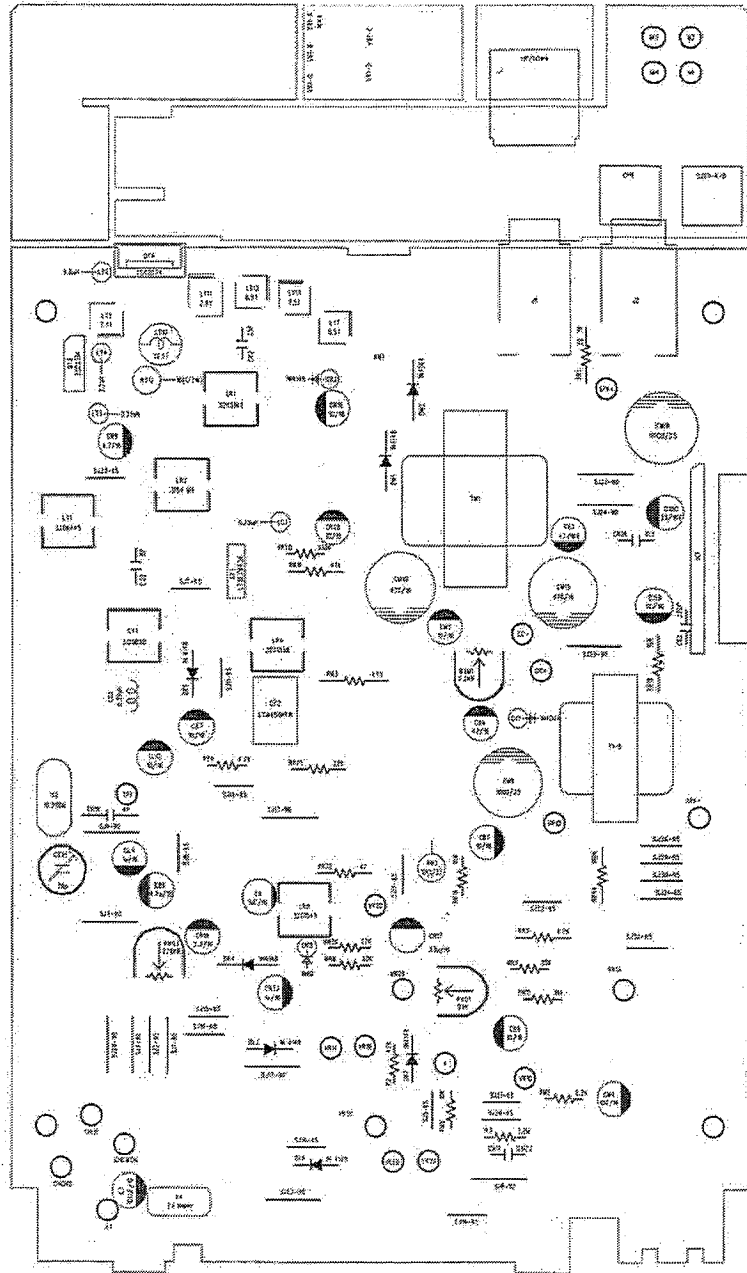

TOP VIEW

VOLTAGE CHARTS

- IC

(CH:1, RX : SQ OFF / UNIT : VOLT)

IC	Pin No.	RX(V)	TX(V)	IC	Pin No.	RX(V)	TX(V)
IC4 CPU	1	GND	GND		33	0	4.8
	2	X IN	X IN		34	N.A	N.A
	3	X OUT	X OUT		35	N.A	N.A
	4	GND	GND		36	GND	GND
	5	4.4	4.4		37	GND	GND
	6	0	0		38	4.8	4.8
	7	0	0		39	4.8	4.8
	8	3.0	3.0		40	N.A	N.A
	9	3.4	0		41	N.A	N.A
	10	0.6	4.8		42	N.A	N.A
	11	N.A	N.A		43	N.A	N.A
	12	5	5		44	N.A	N.A
	13	5	5		45	LCD1	LCD1
	14	PULSE	PULSE		46	LCD2	LCD2
	15	PULSE	PULSE		47	LCD3	LCD3
	16	0	0		48	LCD4	LCD4
	17	N.A	N.A		49	LCD5	LCD5
	18	4.8	4.8		50	LCD6	LCD6
	19	4.8	4.8		51	LCD7	LCD7
	20	N.A	N.A		52	COM3	COM3
	21	N.A	N.A		53	COM2	COM2
	22	4.8	4.8		54	COM1	COM1
	23	0	4.8		55	COM0	COM0
	24	0	4.8		56	3.5	3.5
	25	PLL-STB	PLL-STB		57	2.4	2.4
	26	DATA	DATA		58	1.2	1.2
	27	CLK	CLK		59	N.A	N.A
	28	N.A	N.A		60	N.A	N.A
	29	0	0		61	N.A	N.A
	30	N.A	N.A		62	N.A	N.A
	31	N.A	N.A		63	4.4	0
	32	N.A	N.A		64	N.A	N.A

IC	Pin No.	RX(V)	TX(V)	IC	Pin No.	RX(V)	TX(V)
IC1 KIA7217	1	13.8	13.8		6	3	3
	2	12.5	12.5		7	1.5	3
	3	2.2	2		8	0	1
	4	12	8		9	GND	GND
	5	0.2	1.5		10	10	6.2
IC	Pin No.	RX(V)	TX(V)	IC	Pin No.	RX(V)	TX(V)
IC5 TB31202 FN	1	F-IN	F-IN		9	4	4
	2	4.8	4.8		10	X OUT	X OUT
	3	2	2.5		11	X IN	X IN
	4	GND	GND		12	0	0
	5	4.8	4.8		13	GND	GND

6	CLK	CLK		14	4.8	4.8
7	DATA	DATA		15	4.8	4.8
8	STB	STB		16	4.8	4.8

TANSISTOR

REF. NO	Receive			Transmit		
	B(V)	E(V)	C(V)	B(V)	E(V)	C(V)
QR1	0.7	0	0	0	0	3
QR2	1.5	0.8	8	0	0	0
QR3	2	1.4	6.8	0	0	0
QR4	1.8	1	7	0	0	0
QR5	1.8	1	7	0	0	0
QR6	1.8	1	13.8	0	0	13.8
QR7	0.2	0.5	0.5	0	0	0
QR9	0.7	0	0	0.7	0	0
QR11	0	0	3	0	0	0
QT1	0	0	0	2	0	9
QT2	0	0	13.8	0.8	0	13.8
QT3	0	0	13.8	0.8	0	13.8
QT4	0	0	13.8	0.8	0	13.8
QT5	0	0	9	2.5	0	0
QM1	0	0	0	0	0.8	0
QM2	0	0	0	1.8	0	0
QM3	0	0	0	0.7	1.2	0
QM4	8.8	8.8	0	0	8.8	8.8
QL1	0.8	0	3.8	0.8	0	3.8
QL2	5	0	8.2	5	0	8.2
QL3	0.8	0	6	0.8	0	6
QB1	9.2	8.8	13.8	9.2	8.8	13.8
QB2	8.8	8	8.8	0.4	0	8.8