



The Superior

AR820 0

WIDE RANGE ALL MODE
RECEIVER
530 kHz ~ 2040 MHz



OPERATING MANUAL

(1) AR8200 Index

(1) Index	1
1-1 Introduction	5
1-2 Take care of your radio	5
1-3 Attention while operating	6
1-4 Accessories supplied	7
1-5 Controls & functions	8
1-5-1 Keypad	9
1-5-2 Summary of keys	10
1-5-3 Side panel	15
1-6 Power supply and battery charging	16
1-6-1 Internal batteries	16
1-6-2 Charging the NiCads	18
1-6-3 Cigar lighter lead	18
1-6-4 Battery considerations	19
(2) Making the AR8200 ready for operation	20
2-1 LCD (Liquid Crystal Display)	20
2-2 Connect the aerial (antenna)	21
2-3 Fit the batteries	21
2-4 Keypad and knobs... what you need to know 'most'	22
2-4-1 ENTER key	22
2-4-2 FUNCTION key	22
2-4-3 PASS key	22
2-4-4 CLEAR key	23
2-4-5 MONITOR key	23
2-4-6 KEY lock	23
(3) Basic manual operation of the receiver	24
3-1 Switching On	24
3-2 2VFO twin VFO selection	24
3-3 Entering a frequency using the numeric keypad	26
3-4 Correcting frequency input	27
3-5 Changing frequency using the \uparrow and \downarrow keys	28
3-6 Changing frequency using the main dial	28
3-7 Changing receive mode	29
3-7-1 Auto-mode selection	29
3-7-2 Receive mode selection menu	29
3-8 Changing tuning STEP size	31
3-9 STEP-adjust	33
3-9-1 Automatic calculation of step adjust	33
3-9-2 Cancelling step adjust	34
3-9-3 Manual setting of step adjust	34
3-10 FREQUENCY OFFSET	36
3-10-1 Using pre-programmed frequency offset data	36
3-10-2 Entering new frequency offset data	37
3-11 Attenuator	38
3-12 Noise limiter	38
3-13 AFC - Automatic Frequency Control	39
(4) VFO enhanced facilities	41
4-1 Quick memories	41
4-1-1 Saving quick memory data	41
4-1-2 Recalling quick memories	42
4-2 VFO scan	42
4-2-1 VFO SCAN sampling time	43
4-3 VFO Search	43
4-3-1 Defining VFO search	43

4-3-2	Starting VFO search	43
4-3-3	Forcing VFO search to resume & changing search direction	44
4-3-4	Locking out unwanted frequencies (PASS)	44
4-3-5	Saving active frequencies to memory	45
4-3-6	Exiting VFO search	46
4-4	VFO environment menu	46
4-4-1	VFO SCAN	46
4-4-2	VFO search DELAY environment	46
4-4-3	VFO search LEVEL squelch environment	47
4-4-4	VFO search VOICE squelch environment	48
4-4-5	VFO FREE search environment	48
4-4-6	VFO AUTO STORE environment	49
4-4-7	VFO DELETE bank "J" environment	49
4-4-8	VFO QUICK MEMORY environment	50
(5)	Memory channels & banks	51
5-1	Memory channel overview	51
5-2	Storing VFO frequencies & data into memory	52
5-2-1	Another example of memory write	54
5-2-2	Automatic memory allocation	55
5-3	Memory write protect	55
5-4	Memory read "M.RD"	56
5-4-1	Memory channel review / hunt	57
5-5	Deleting memory channels	57
5-5-1	Memory channel editing	58
5-5-2	Adding text names to memory banks	58
5-6	Transfer of memory channel to VFO	58
5-7	Dynamic memory bank resizing	58
(6)	Priority operation	59
6-1	Engaging PRIORITY channel	60
6-2	Changing PRIORITY channel data	60
6-2-1	Changing the priority channel data pickup channel	61
6-2-2	Changing priority interval time	61
(7)	SCAN - scanning memory channels & banks	62
7-1	SCAN - outline introduction	62
7-2	SCAN considerations	62
7-3	Starting to SCAN	63
7-3-1	Transfer of active memory to VFO	64
7-4	Selecting a scan bank	64
7-5	Channel PASS	64
7-5-1	Toggling memory channel PASS	65
7-5-2	Removing ALL memory PASS tags in one go	65
7-6	Deleting memory channels	66
7-6-1	Deleting single memory channels	66
7-6-2	Deleting whole memory banks in one go	66
7-7	Scan bank link (scan group)	66
7-8	Additional scan facilities	67
7-8-1	Scan DELAY	68
7-8-2	Scan LEVEL	68
7-8-3	Scan VOICE	69
7-8-4	Scan FREE	70
7-8-5	Scan (receive) MODE	70
7-8-6	Write protect of memory channels & banks	71
7-9	Select scan	71
7-9-1	Adding select scan channels in memory read	71
7-9-2	Starting / stopping select scan	71
7-9-3	Select scan environment	72

7-9-4	Editing the contents of the select scan list	72
7-9-5	Deleting all select scan channels	73
(8)	Search mode	74
8-1	Search types	74
8-1-1	Program search overview	74
8-2	Starting program search	75
8-2-1	Reversing the direction of search	75
8-2-2	Forcing the search to resume	75
8-2-3	Stopping the search	75
8-2-4	Copying an active frequency to the VFO or memory location	76
8-3	Selection of search bank	76
8-4	Programming a search bank	78
8-5	Locking out unwanted active frequencies (PASS)	80
8-5-1	Search pass menu	80
8-6	Search bank link	81
8-7	Additional search facilities	82
8-7-1	Search DELAY	83
8-7-2	Search LEVEL	84
8-7-3	Search VOICE	84
8-7-4	Search FREE	85
8-7-5	AUTO STORE	86
8-7-6	DELETE bank "J"	86
8-7-7	Deleting search banks	87
8-7-8	Write protect and copying search banks	87
(9)	EDIT menu	88
9-1	EDIT COPY memory channel	88
9-2	EDIT COPY memory bank	89
9-3	EDIT COPY search bank	90
9-4	EDIT MOVE memory channel	90
9-5	EDIT SWAP memory channel	91
9-6	EDIT memory channel	92
9-7	EDIT Search protect	93
(10)	DELETE menu facilities	94
10-1	DELETE search banks and search PASS frequencies	94
10-2	DELETE VFO PASS	95
10-3	DELETE memory bank	95
10-4	DELETE select scan channels	96
10-5	DELETE memory channel protect	96
10-6	DELETE memory channel pass	97
(11)	Write protect	98
11-1	Memory CHANNEL write protect	98
11-2	Write protect during memory input	98
11-3	Channel protect status for existing memory channels	98
11-4	Channel protect delete	99
11-5	Memory BANK write protect	99
11-6	Search bank write protect	100
11-7	Global write protect	100
(12)	TEXT search and input	101
12-1	Text input menus	101
12-2	Text search	102
(13)	SHORT CUT keys	103
13-1	Short cut menu access	103
13-2	Short cut text entry	104
13-3	Short cut text entry, keypad with ⏪⏩⏴⏵ keys	105

(14) Configuration menu	106
14-1 CONFIG BEEP	106
14-2 CONFIG LAMP	106
14-3 CONFIG CONTRAST	107
14-4 CONFIG Power save	108
14-5 CONFIG Auto power off	109
14-6 CONFIG REMOTE BPS	109
14-7 CONFIG FREQ DISP	110
14-8 CONFIG GLOBAL write protect	110
14-9 CONFIG Opening message	111
(15) Band scope	112
15-1 Starting the band scope	112
15-2 Exit from band scope	113
15-3 Setting frequency span width (waveform enlargement)	113
15-4 Moving the marker	113
15-5 Marker to strongest signal (peak search)	113
15-6 Entering a new centre frequency	114
15-7 Transfer of marker frequency to VFO	114
15-8 Peak hold	114
15-9 Saving active trace to memory	114
15-10 Loading stored band scope traces from memory	115
(16) Sleep	116
(17) Option socket	117
17-1 RS232 operation	118
17-2 CLONE of data via the option socket	118
17-2-1 How to clone data	119
(18) Slot card socket	121
18-1 Optional slot cards	121
18-1-1 Fitting the slot card	121
18-1-2 Removing the slot card	122
18-2 VI8200 optional voice inverter slot card	122
18-3 CT8200 optional CTCSS slot card	123
18-3-1 CTCSS tone squelch	123
18-3-2 CTCSS search	124
18-4 TE8200 optional tone eliminator slot card	125
18-5 RU8200 optional record & playback slot card	126
18-5-1 Recording	126
18-5-2 Playback	127
18-6 EM8200 optional external extended memory slot card	127
18-6-1 Initialising (formatting) the EM8200 before use	128
18-6-2 EM8200 ALL-DATA save and load	129
18-6-3 EM8200 ALL-MEM save and load	130
18-6-4 EM8200 MEMORY BANK save and load	131
18-6-5 EM8200 ALL-SRCH save and load	132
18-6-6 EM8200 SEARCH BANK save and load	132
18-6-7 EM8200 internally stored band scope save and load	133
(19) Trouble shooting	136
19-1 Soft reset of microprocessor	136
19-2 Other trouble shooting suggestions	136
19-3 Trouble shooting - Take note of the following	137
(20) Optional accessories	138
(21) Aerial (antenna), earths & propagation	139
(22) Specification	140

1-1 Introduction

Thank you for purchasing the AR8200 hand held wide band all mode receiver. The AR8200 is designed using the very latest technology to ensure the highest levels of performance and reliability. To get the best possible results from your AR8200 we recommend that you read this manual and familiarise yourself with the receiver. Although carefully designed, this receiver (like all receivers) suffers from a degree of internal noises known as spuri. They are a product of the receiver's circuitry and do not represent a fault. Apparent faults may be due to accidental misoperation of the receiver, if you think there is a problem, carefully read all of the manual before deciding to contact your equipment supplier for advice.

It is acknowledged that sections of this manual are repetitive, this is to enable the manual to be used as a reference book (you don't have to read it all from cover to cover in one go). Due to the international nature of the product, some graphics contain Japanese characters.

Every effort has been made to make this manual correct and up to date. Due to continuous development of the receiver and by error or omission anomalies may be found and this is acknowledged.

© This manual is protected by copyright AOR Ltd 1998. No information contained in this manual may be copied or transferred by any means without the prior written consent of AOR Ltd. AOR and the **AOR** logo are trade marks of AOR Ltd. All other trade marks and names are acknowledged. E&OE

1-2 Take care of your radio

There are no internal operator adjustments. In the unlikely event of servicing being required, please contact your dealer for technical assistance.

Do not use or leave the receiver in direct sunlight (especially the LCD). It is best to avoid locations where excessive heat, humidity, dust and vibration are expected. Always keep the AR8200 free from dust and moisture. Use a soft, dry cloth to gently wipe the set clean, never use abrasive cleaners or organic solvents which may damage certain parts. Treat the AR8200 with care, avoid spillage or leakage of liquids into the receiver and a.c. charger. Special care should be taken to avoid liquid entering around the controls, through the speaker grille or via the connection jacks.

The AR8200 is designed for operation from internal batteries or from its supplied a.c.-to-d.c. charger. Operation is possible from any good quality regulated d.c. supply of 12 to 14V, which should be capable of supplying 300mA. **Never connect the AR8200 directly to the a.c. supply.**

The d.c. input socket uses a mini 1.3mm power connector. This connector is configured CENTRE POSITIVE, the chassis of the receiver is at negative ground. The charger supplied is pre-wired and provides a nominal 12V d.c. output with suitable connectors being fitted as standard for the a.c. power input and connection to the AR8200.

SAFETY NOTICE - Always disconnect the charger from the a.c. socket when not in use.

If using the AR8200 in a base station situation, the best short wave reception is usually achieved by the fitting of a separate external earth rod, however consider the implications carefully if your a.c. building supply uses a Protective Multiple Earth (PME) system. If in doubt consult an expert electrician. Never earth to a gas pipe!

The AR8200 has a single BNC aerial socket for all frequencies. This is intended for connection to its supplied whip aerial or a 50 OHM (unbalanced) coaxial fed aerial such as a discone, dipole, unipole, yagis etc. When sighting the aerial, avoid power cables.

Operating anomalies

Should the AR8200 appear to behave strangely, normal operation may be easily achieved by resetting the microprocessor. Two scenarios may be encountered due to power transients etc:

1. **Symptom:** LCD remains on, no control of the keypad.
Action: Remove any connection to external power such as the charger or cigar lead, remove one NiCad battery and count to thirty! Re-fit the battery and press the power switch again. Normal operation should be restored but the last used frequency will be lost, the AR8200 will restore the last but one frequency to display.
2. **Symptom:** The AR8200 fails to power up.
Action: Try the suggestion given in (1) then hold the **CLEAR** key while powering up the AR8200 to 'Soft reset' the microprocessor.

1-3 Attention while operating

1. Certain key operations are acted upon when the key is RELEASED, not while it is pressed. Allow time for the AR8200 to register such actions before pressing another key.
2. The keylock ●K.L. is intentionally made to be *difficult to operate* to prevent accidental operation. To release keylock, the ●K.L. key has to be held for more than one second, the key legend on the LCD confirms operation. The ●K.L. key is disabled during keying sequences (such as when entering frequencies).
3. If a key sequence is not completed, the microprocessor will automatically abort most operations after about 90 seconds of keypad inactivity.
4. Currently displayed VFO data is saved at power down (to increase speed of operation and to reduce write cycles). For this reason, if the AR8200 is powered down by removing external supply (without internal batteries in place or when the batteries become exhausted), the last displayed frequency will be lost and the frequency used prior to this will be displayed when next powered up.

Terminology - Search & Scan

If you have not used a wide range monitor before or are not familiar with the terminology used, it is very important to understand the difference between SEARCH and SCAN modes.

SEARCH: The AR8200 provides several operations where transmissions (active frequencies) may be automatically located by sweeping the receiver over a wide frequency range, either from the currently displayed frequency travelling upwards (or downwards) in a specified tuning increment (step) or by sweeping over-and-over between two specified frequency limits. This process is known as SEARCHING, as the title implies, it can take a long time to find transmissions due to their 'often intermittent' and brief nature. For this reason it is best to slice large frequency ranges into smaller, more manageable pieces where they may be intensively studied. When examining large frequency bands, it is common to find that 90% of frequencies are inactive and only a small number of the remaining constitute what you really want. Searching still remains the best way to initially locate active and interesting transmissions (in conjunction with a good frequency listing and band plan).

SCAN: Once active transmissions have been identified (either by searching or by using a good frequency guide), it is more efficient to store the data into memories which can be rapidly and automatically monitored in succession stopping when activity is encountered. This forms a much

more efficient means of monitoring the most wanted frequencies as you have targeted 100% what you most want to hear, by contrast searching is very inefficient for day-to-day monitoring.

 **Note: It is very important that the squelch is advanced to cancel background noise for the search & scan facilities to operate.** This is because the AR8200 believes that it has found an active frequency when the squelch opens and "S" 'squelch open' legend is displayed to the left of the signal meter. Advance the squelch control clockwise until the background noise is just cancelled, this is known as the threshold position. If the squelch control is advanced too far, weaker signals may be missed.

No noise and no "S" legend (with squelch advanced clockwise passed threshold) = **squelch closed.**

Signal received or 'noise' emanating from speaker (squelch fully anti-clockwise, below threshold) with no "S" legend = **squelch open.**

1-4 Accessories supplied

The following items are provided in the carton box:

1 x	AR8200 receiver
1 x	Whip aerial in BNC connector
1 x	Medium Wave (MW) bar aerial
4 x	AA NiCad batteries
1 x	Charger (may be supplied in a separate cartons in some world market areas)
1 x	Cigar adapter lead (containing internal 1A fuse)
1 x	Hand strap
1 x	Belt hook with two screws
1 x	Operating manual (this booklet)

How to fit the hand strap

The hand strap anchor is located on the right hand side of the AR8200 cabinet. The hand strap comprises of two loops, one large and one small. Feed the small loop through the anchor then feed the large loop through the small loop and gently pull until tight. This strap is designed to be looped over your wrist to prevent the AR8200 from contacting the ground if accidentally dropped, it is not intended as a hard wearing utility... do not swing the set or abuse the set using this hand strap.

The MW bar also has a fixing hole so that you may tie it down to prevent loss.

How to fit the belt hook

The belt hook is a shaped metal plate with two fixing holes on the top edge, two fixing screws are provided. **Do not use any other screws...** if you attempt to use longer screws, the internal parts may be permanently damaged rendering the AR8200 inoperative. Offer the belt hook to the rear of the AR8200, locate and align the fixing holes then carefully fit the two supplied screws, fit both screws before tightening with a cross-head screwdriver.

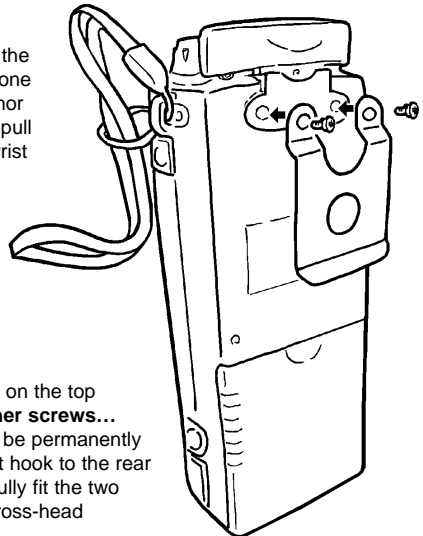

1-5 Controls & functions

Controls are located on the top, front and left hand side of the AR8200, a brief identification is given here:

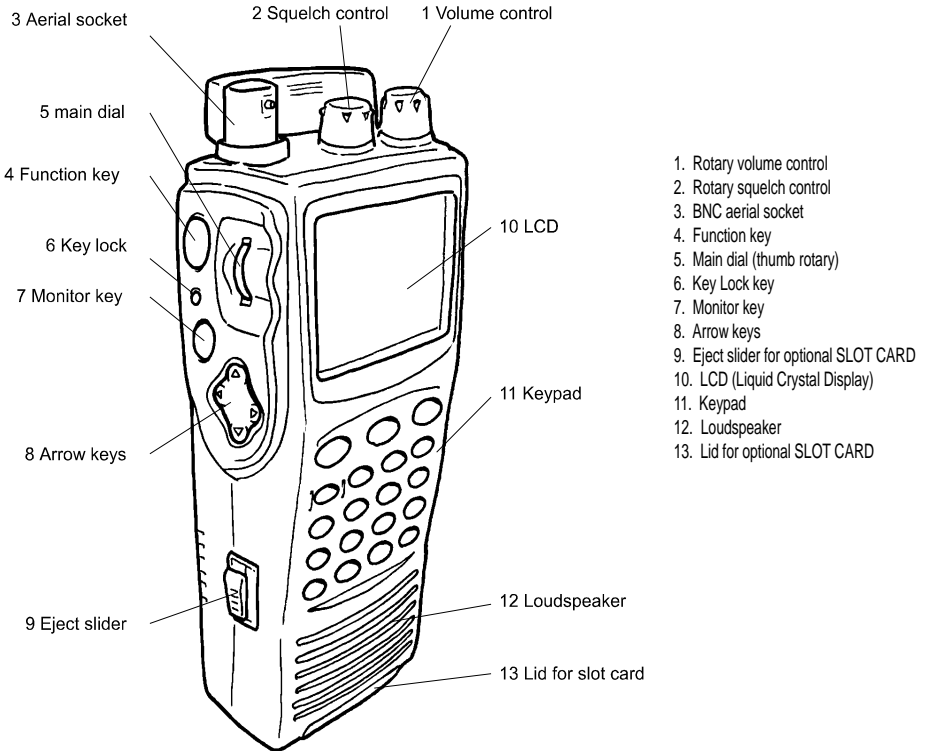

14. Hand strap anchor
15. Earphone / external speaker socket
16. External power / charging socket
17. Option socket
18. Medium Wave (MW) bar aerial
19. Battery compartment cover
20. Battery compartment release slider

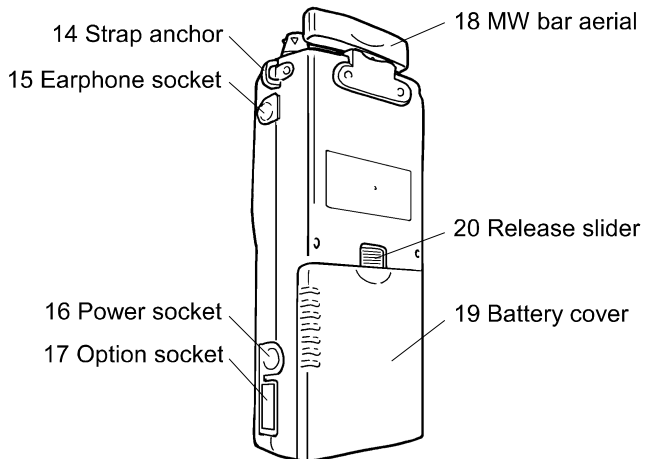

1-5-1 Keypad

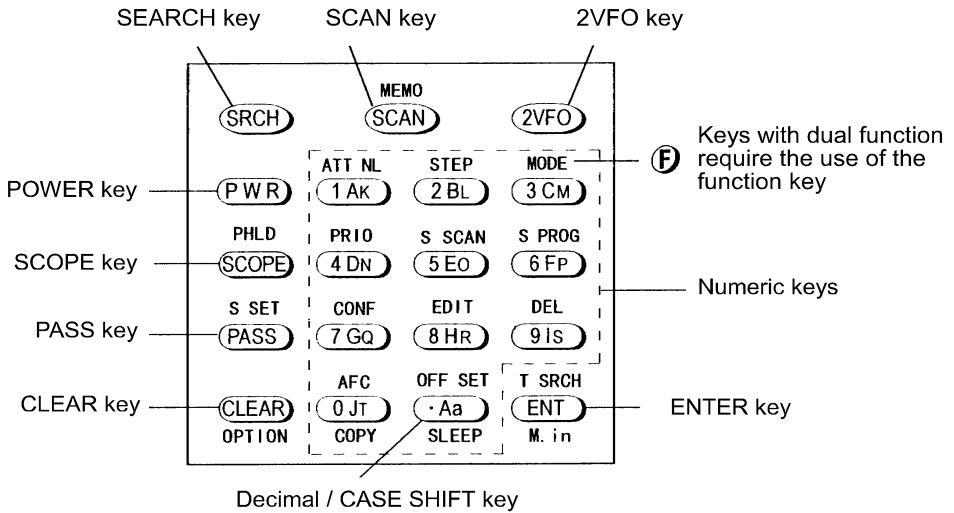

Keypad conventions

Most keys have multiple functions, their functions are printed on the cabinet. However due to the restriction of available size, not all facilities can be shown on the keypad printing. To ease access to the many facilities, two formats are employed:-

PUSH **Push and release the key quickly** to access the required facility. This applies to primary facilities of keys such as numeric 1, 2, 3 etc. Also for example, quickly **PUSH** the **2VFO** key while in 2VFO mode to toggle between the two VFOs VFO-A and VFO-B.

PRESS **Press and HOLD the key for more than one second** to access the second function, sometimes this is in conjunction with the (F) key.

(F) Function key manipulation

The (F) key also may be used by PUSH and PRESS depending upon the specific requirement, in most cases however the (F) key will require a simple PUSH.

“FUNC” LCD legend **solid** = PUSH (F)

“FUNC” LCD legend **flashing** = PRESS (F)



1-5-2 Summary of keys

The main keypad is located on the front cabinet of the AR8200 with other keys located on the left hand side. When powered from internal batteries with the lamp configured to AUTO, the lamp will automatically illuminate when keys are pressed and will stay illuminated for five seconds after the last key press.

An optional CC8200 RS232 lead is required for computer control, the optional CO8200 lead is required for copying data between two AR8200 radios, various optional SLOT CARDS are available which further extend the AR8200 facilities (and menus).

SRCH

PUSH this key to place the AR8200 into SEARCH mode, the LCD "SRCH" legend confirms operation.



PUSH  PUSH  to access the bank link menu where up to ten different selections of linked search banks may be grouped, this is useful where a large frequency band has been split up into smaller more manageable sizes for close scrutiny.

Additional search related parameters may be set up to optimise each search group independently using this menu:-



DELAY	OFF / HOLD / 0.1s to 9.9s (default = OFF)
LEVEL	OFF / 1 to 255 (default = OFF)
VOICE	OFF / 1 to 255 (default = OFF)
FREE	OFF / 1s to 60s (default = OFF)
AUTOSTORE	ON / OFF (default = OFF)
DELETE J	(deletes the current data from bank J)

SCAN

PUSH this key to place the AR8200 into MEMORY READ mode, the LCD legend "M.RD" confirms selection. PUSH  again to initiate SCAN, the LCD legend "SCAN" confirms selection

PUSH  PUSH  to access the bank link menu where up to ten groups of memories may be selected to be scanned in succession, effectively forming one large scan bank. Additional scan related parameters may be set up to optimise each scan group independently using this menu:-

DELAY	OFF / HOLD / 0.1s to 9.9s (default = OFF)
LEVEL	OFF / 1 to 255 (default = OFF)
VOICE	OFF / 1 to 255 (default = OFF)
FREE	OFF / 1s to 60s (default = OFF)
MODE SCAN	ALL / WFM / NFM / SFM / WAM / AM / NAM / USB / LSB / CW (default = ALL)



PUSH  PRESS  to set the ratio of bank size between memory channels sharing a common letter in upper and lower case.

2VFO

PUSH this key to place the AR8200 into 2VFO mode where you may receive spot frequencies and 'generally monitor activity'. The LCD displays two lines of frequency readout, the upper (larger) being the current receive frequency. The LCD legend "2VFO" confirms selection with each VFO being identified as "V-A" and "V-B".

PUSH  **2VFO** again to toggle between VFO-A "V-A" and VFO-B "V-B".

PRESS  **2VFO** to initiate VFO search between the two displayed frequency limits set by VFO-A and VFO-B, the legend "V-SR" confirms selection of VFO SEARCH.

PUSH  **F** PRESS  **2VFO** to access the VFO MODE select menu where the following parameters may be configured:-

VFO SCAN	ON / OFF (default = OFF)
DELAY	OFF / HOLD / 0.1s to 9.9s (default = OFF)
LEVEL	OFF / 1 to 255 (default = OFF)
VOICE	OFF / 1 to 255 (default = OFF)
FREE	OFF / 1s to 60s (default = OFF)
AUTOSTORE	ON / OFF (default = OFF)
DELETE J	(deletes the current data from bank J)
QUICK MEMORY	OFF / 10s to 990s (default = OFF)



PWR

PRESS this key to switch the AR8200 on and off as a toggle. To prevent accidental switch on and off, the power key is placed between two ridges and has to be held for more than one second for the press to be registered. The ridges also help location of the power key when operated in areas of low level lighting.

SCOPE

PUSH this key to activate the band scope, PUSH  the **SRCH**, **SCAN** or **2VFO** key to return to normal operation.

 **Note:** Priority operation is disabled when the band scope facility is in use.



Traces will be overwritten as the band scope is written from left to right on the LCD. To build up a long term activity display, PUSH  **F** PUSH  **SCOPE** to toggle the PEAK HOLD facility on / off, the LCD legend "HLD" confirms operation.

The key sequence PUSH  **F** PRESS  **SCOPE** recalls a previously saved band scope trace.

PASS

PUSH this key to PASS (lockout) memory channels during memory read & scan mode and to PASS (skip) unwanted frequencies in search mode. Also acts as select ON/OFF/DEFAULT toggle in various menus.

PRESS  **(PASS)** in 2VFO mode to access the VFO PASS menu which extends to include the SEARCH bank pass edit menu.

PUSH  **(F)** PRESS  **(PASS)** in 2VFO, SEARCH or SCAN mode to access the SELECT SCAN edit menu.

(CLEAR)



PUSH to abort entry via the keypad.



PRESS  **(CLEAR)** to select the optional SLOT CARD when fitted.

PRESS  **and HOLD** the **(CLEAR)** key while powering On the AR8200 to soft reset the microprocessor should the AR8200 appear to behave strangely... no memory contents will be lost.

(1 AK)



Numeric figure one during frequency input. Selection of memory/scan bank "A" or "a" and search bank "A" or "a" or "K" or "k".

PUSH  **(F)** PUSH  **(1 AK)** to toggle the attenuator on / off, the LCD legend "ATT" confirms operation.

PUSH  **(F)** PRESS  **(1 AK)** to toggle the noise limiter on / off, the LCD legend "NL" confirms operation.



(2 BL)



Numeric figure two during frequency input. Selection of memory/scan bank "B" or "b" and search bank "B" or "b" or "L" or "l".

PUSH  **(F)** PUSH  **(2 BL)** to access the tuning STEP size (increment) menu.

(3 CM)



Numeric figure three during frequency input. Selection of memory/scan bank "C" or "c" and search bank "C" or "c" or "M" or "m".



PUSH  **(F)** PUSH  **(3 CM)** to access the receive mode selection menu.

PUSH  **(F)** PRESS  **(3 CM)** to select AUTO-MODE where the receiver mode and tuning step are automatically selected by the AR8200 microprocessor from the pre-programmed band plan data (**this is a short cut to save using the receive mode menu**). The LCD legend "AUT" confirms that auto-mode is in operation.

4 DN



Numeric figure four during frequency input. Selection of memory/scan bank “D” or “d” and search bank “D” or “d” or “N” or “n”.

PUSH  (F) PUSH  **4 DN** toggles the priority facility on/off (assuming that one has already been assigned using the priority menu). The LCD legend “PRI” confirms when priority has been selected.

PUSH  (F) PRESS  **4 DN** to access the priority menu where the data from a memory channel may be assigned for priority use. The interval sampling time may also be specified.

5 EO



Numeric figure five during frequency input. Selection of memory/scan bank “E” or “e” and search bank “E” or “e” or “O” or “o”.

PUSH  (F) PUSH  **5 EO** to initiate select scan (assuming that more than one memory channel has already been tagged for select scan). The LCD legend “SEL” indicates when select scan is active.

PUSH  **SRCH** or **SCAN** or **2VFO** to exit select scan.



6 FP

Numeric figure six during frequency input. Selection of memory/scan bank “F” or “f” and search bank “F” or “f” or “P” or “p”.

PUSH  (F) PUSH  **6 FP** to access the program search menu where upper / lower frequency limits etc for search mode may be entered.



7 GQ

Numeric figure seven during frequency input. Selection of memory/scan bank “G” or “g” and search bank “G” or “g” or “Q” or “q”.

PUSH  (F) PUSH  **7 GQ** to access the configuration menu where the beep, lamp, LCD contrast, RS232 etc. may be configured.



8 HR



Numeric figure eight during frequency input. Selection of memory/scan bank “H” or “h” and search bank “H” or “h” or “R” or “r”.

PUSH  (F) PUSH  **8 HR** to access the edit menu when memory channels and search banks may be amended and copy protection configured.

9 IS



Numeric figure nine during frequency input. Selection of memory/scan bank "I" or "i" and search bank "I" or "i" or "S" or "s".



PUSH  (F) PUSH  **9 IS** will delete the currently displayed memory channel during memory read or scan.

PUSH  (F) PRESS  **9 IS** accesses the delete menu where search banks, VFO pass frequencies, memory banks, select channel tags, channel protect status & memory pass tags may be deleted.

0 JT



Numeric figure zero during frequency input. Selection of memory/scan bank "J" or "j" and search bank "J" or "j" or "T" or "t".



PUSH  (F) PUSH  **0 JT** to toggle the AFC (Automatic Frequency Control) facility on/off, the LCD legend "AFC" confirms selection.

PUSH  (F) PRESS  **0 JT** to access the clone (*copy between radio*) menu.

• Aa



Numeric decimal during MHz format frequency input. Used in memory and search as a **CASE SHIFT** key to toggle between UPPER and LOWER case banks.

PUSH  (F) PUSH  **• Aa** to access the frequency offset menu.



PUSH  (F) PRESS  **• Aa** to access the sleep timer menu.

ENT

Used as an ENTER key to accept data entry.

PUSH  **ENT** during VFO operation to write the current frequency to QUICK MEMORY where the key sequence PUSH  (F) PUSH  ⇌ recalls quick memory. The ⇌ keys may be used to cycle through the quick memories, the LCD legend "★" indicates when a quick memory has been recalled.

PRESS  **ENT** to enter the current frequency in to one of the 1,000 memory channels.

PUSH  (F) PUSH  **ENT** to access the text search menu.

1-5-3 Side panel

The left hand side of the AR8200 comprises of three push keys, a nest of four arrow keys and a rotary main dial. An eject slider is also provided to release the optional SLOT CARD.

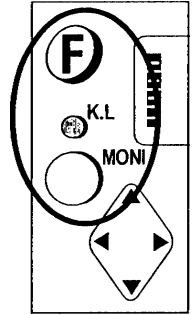

FUNCTION KEY (F)

The function (shift) key is used to select the second function of keypad facilities.

PUSH (F) to toggle the function status on/off. A solid reverse legend LCD "FUNC" indicates when function shift is in operation. The function status is terminated automatically in the normal course of entry.

PRESS (F) to initiate *double-shift* which is used in certain menus as a short-cut. The reverse "FUNC" legend flashes when *double-shift* is engaged.

Note: When the "FUNC" legend is displayed in VFO mode, the tuning speed will be increased to assist rapid frequency change using the arrow keys and main dial.

● K.L.

The **KEY LOCK** is intentionally small to reduce the chances of accidental operation. Key lock is useful when you do not wish an important frequency to be lost or the AR8200 to be incorrectly set to a different frequency. The key lock status is *not* deactivated by switch off / on, the (PWR) and (MONI) keys are not affected by key lock.

PRESS ● K.L. to toggle the key lock on /off, an LCD key symbol "🔑" indicates status.

○ MONI

The **MONITOR** key is used to force the squelch open so that you may manually intervene to ensure that no weak signals are missed. **PRESS** and **hold** the (MONI) key to defeat the squelch control (saves turning the squelch control fully anti-clockwise then back to threshold position).

When the "DUP" legend is displayed during frequency offset or VFO SCAN (DUPLEX) operation, the (MONI) key forces the AR8200 to switch to the alternative frequency.

In SCOPE mode, the (MONI) key enables the reception of the marker frequency.

MAIN DIAL

This recessed rotary control is intended to be scrolled up and down using the thumb of your left hand (although you may adjust it using the middle finger of your right hand etc). Primarily this is the tuning control, upward rotation tunes the AR8200 upward in frequency and downward rotation tunes downward in frequency using the selected tuning step size. When the "FUNC" legend is displayed, the tuning speed will be increased. The main dial is also used to move between menus and manipulate input through menus (generally mimicking the arrow keys).

Note: The main dial also has a switch capability, this is why the main dial has lateral movement. However, this switch capability is not used by the AR8200.

ARROW KEYS

The arrow keys ⇐⇒⇑⇓ are laid out as a group of four keys (up, down, left and right). This format is particularly convenient when used with the thumb of the left hand (although you may use it with the middle finger of your right hand etc) for navigation through on-screen menus.



The right arrow key is used as a backspace when entering frequency via the keypad. Also selects bank in memory read mode, moves the cursor position (especially during text input), tunes the receiver and changes values in menus.



The left arrow key selects bank in memory read mode, moves the cursor position (especially during text input), tunes the receiver and changes values in menus.



The up arrow key increments to next memory channel in memory read mode, tunes the receiver in VFO mode, selects menu items, changes values in on-screen menus and forces scan & search to resume when stopped on a busy channel.



The down arrow key increments memory channel in memory read mode, tunes the receiver in VFO mode, selects menu items, changes values in on-screen menus and forces scan & search to resume when stopped on a busy channel.

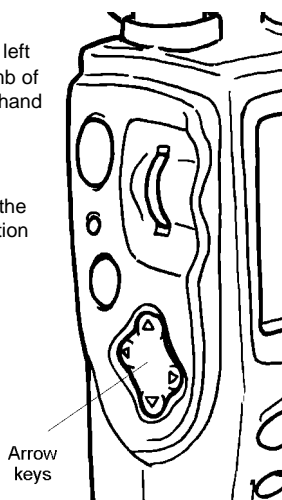

 **Note:** It is possible to push two of the arrow keys at the same time (in error) by using diagonal force, **ensure that the arrow keys are operated cleanly and one at a time.**

1-6 Power supply and battery charging

The AR8200 is designed for operation from internal batteries or from its supplied a.c.-to-d.c. charger. Operation is possible from another good quality regulated d.c. supply of 12 to 14V, which should be capable of supplying 300mA. **Never connect the AR8200 directly to the a.c. supply.**

The d.c. input socket uses a mini 1.3mm power connector. This connector is configured CENTRE POSITIVE, the chassis of the receiver is at negative ground. The charger supplied is pre-wired and provides a nominal 12V d.c. output with suitable connectors being fitted as standard for the a.c. power input and connection to the AR8200.

SAFETY NOTICE - Always disconnect the charger from the a.c. socket when not in use.

If you are not going to use the AR8200 on batteries for a while, remove the batteries from the radio (to prevent dry cells leaking) and charge NiCads before placing them into storage.

1-6-1 Internal batteries

The AR8200 is supplied with four AA size NiCad rechargeable batteries. These batteries are not charged at the factory before shipping, so you will need to charge them before use.

Dry cells such as Alkaline or Zinc / Manganese may be used but **cannot be charged inside the AR8200**, if dry cells are fitted to the AR8200, **remove dry cells before using the cigar lead or connecting the charger or external power.**

The AR8200 charging circuit is not designed to recharge dry cells or NiMH batteries, if these are to be recharged, they must be removed from the AR8200 and charged in a specialist external charger following the manufacturers recommendations.

Fitting batteries

The battery compartment is located on the rear cabinet of the AR8200. A hinge is located at the bottom edge with a 'locking mechanism' on the top edge of the compartment cover. To release the battery compartment locking mechanism, slide the release upward (using a thumb is the best method) then lift the compartment using a rotating action (using the thumb and forefinger of the other hand). Do not use excessive force, the cover is completely detachable.

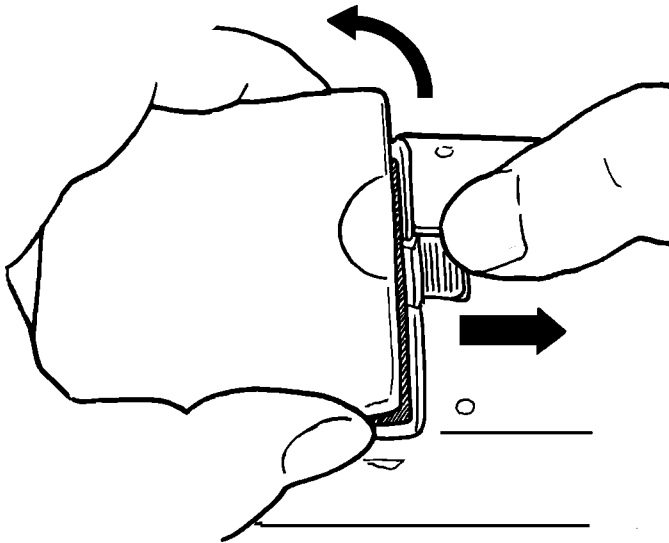

Insert the four NiCads supplied (or alternative AA sized batteries) observing the correct polarity (head to toe positive / negative). Refit the battery compartment cover into the closed position.

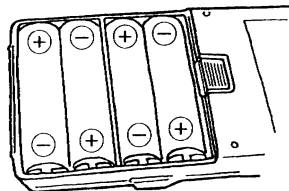

 **Note:** Always switch the AR8200 off before fitting / removing batteries or when connecting / disconnecting external power.

1-6-2 Charging the NiCads

It is possible to charge the supplied NiCad batteries while still fitted inside the AR8200 using the charging unit provided. Switch off the AR8200 then connect the plug from the charging unit to the 12V d.c. input socket on the right hand side of the AR8200 cabinet. Connect the charger to the a.c. supply and switch the power to the charger on.

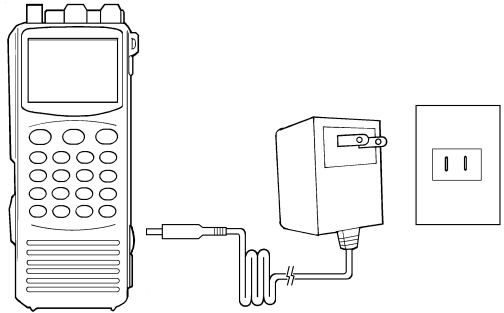

When fully discharged, the NiCad batteries will take 12 hours to fully charge while the AR8200 is switched off. It is possible to charge the AR8200 while the radio is switched on and being used, however the charging cycle will take longer (16 hours is typical) and a degree of hum superimposed on reception may be encountered as the charger is not regulated.

The AR8200 will provide around 4 hours of continuous operation with one third volume and constant reception. The operational time between charges will be dependant upon volume level and operating parameters, the power save facility will also extend operating time.

If connected to an external power supply, the AR8200 may be used for continuous operation.

When the NiCads near discharge, three states will be encountered:-

1. A battery symbol will appear in the extreme top right of the LCD a couple of minutes before the NiCads completely discharge. The operational cut-off point is difficult to determine making advance warning brief. The legend will have one diagonal bar representing minimal charge left.



2. The LCD battery legend will become an empty outline... operation will cease almost immediately.
3. The NiCads will expire and the set will power off (the VFO frequencies and last stored memory may be lost). Connect the charger to continue operation or replace the exhausted cells.

1-6-3 Cigar lighter lead

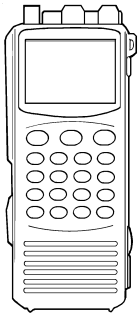

It is possible to use the supplied cigar lead to charge the AR8200 NiCads and to power the radio in exactly the same manner as the a.c. charger (except that it is connected to a vehicle 12V d.c. supply). Ensure that the vehicle has a 12V d.c. battery, **do not connect to a truck / H.G.V. 24V battery.**

The tip on the cigar plug is positive (+), the vehicle must be negative ground. A 1A fuse is fitted inside the cigar lead, should this fuse blow for some reason, ensure it is replaced with the correct type. Avoid short circuits.

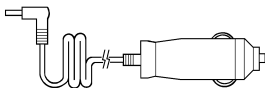

Switch off the AR8200, connect the cigar lead to the AR8200 12V d.c. input socket THEN connect the cigar plug to the vehicle and switch the AR8200 on.

It is advisable to switch the AR8200 off when starting the vehicle as the starter motor often causes power surges. Some vehicles require their ignition to be ON for the cigar socket to operate.

1-6-4 Battery considerations

The supplied NiCads are not factory charged. Fit them to the AR8200 and charge for about 12 hours. After this time the NiCads should never be left in a flat condition or internal filaments will form (inside the NiCads) shorting its terminals rendering it useless. If you are not going to use the NiCads for a while, charge them before placing them into storage. NiCads have a memory effect, for longevity, once a month flatten them completely then fully charge them again. Avoid excessive 'topping up', when possible, it is best to charge NiCads when they are totally flat.

If you have not used the cells for a long time, specialist external chargers may help 'bring them back to life' by first discharging them COMPLETELY then charging at a higher rate than the AR8200 can provide. It is common practice to place exhausted NiCads into a torch to ensure that they are totally flat before charging, this ensures the best life span. Regular charging in a rapid external charger may be convenient but will reduce the life span of the cells.

Do not over-charge, charging for more than 24 hours may significantly shorten the life span of the NiCads. If the NiCads are left charging permanently, there is a small chance of explosion due to the build up of heat. If you intend permanently using the AR8200 from an external power supply, remove one battery to prevent over-charging... or better still remove all the batteries and store them away. Do not short NiCads as they can provide high current levels.

The supplied NiCads will typically provide around 300 charge / discharge cycles.

If dry cells are used (Alkaline, Zinc, Manganese) make sure they are removed if external power is connected to the AR8200. Do not mix cells of different types and do not mix new and used cells.

(2) Making the AR8200 ready for operation

2-1 LCD (Liquid Crystal Display)

All relevant operational information is provided via the large LCD. To see all the available LCD legends, and to test the LCD, an LCD test routine has been provided. **PRESS** and hold the **(0 JT)** key then switch the AR8200 on, **PRESS** **(PWR)**. When the sign-on message has been displayed all LCD graphics will be displayed. To exit the LCD test **PRESS** **(PWR)**. The LCD contrast is adjustable using the configuration menu as is the rear LCD & keypad illumination.

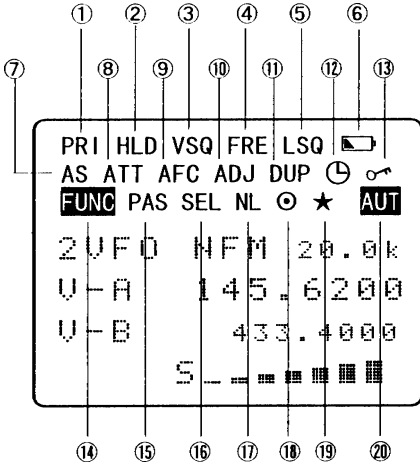

- 1 Priority
- 2 Search hold / band scope peak hold
- 3 Voice squelch
- 4 Free search / scan
- 5 Level squelch
- 6 Low battery
- 7 Auto store
- 8 Attenuator
- 9 Automatic Frequency Control
- 10 Step-adjust
- 11 Duplex
- 12 Sleep
- 13 Key lock
- 14 Function
- 15 Pass (lockout)
- 16 Select scan
- 17 Noise limiter

- 18 RS232 remote
- 19 Band scope peak search / quick memory
- 20 Auto-mode
- 21 Operating mode (2VFO, SRCH, SCAN etc)
- 22 Receive mode
- 23 Tuning step size
- 24 Active receive frequency
- 25 Squelch open legend
- 26 Signal meter

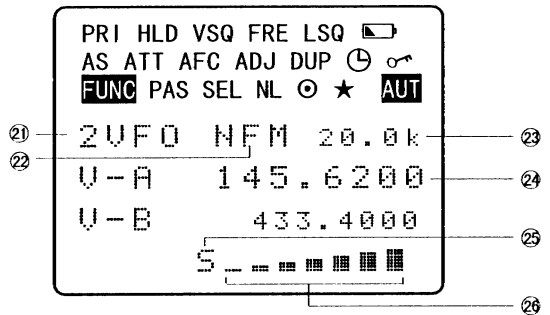

Typical examples of LCD:-

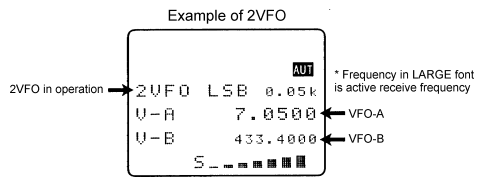
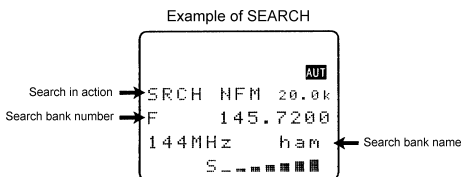

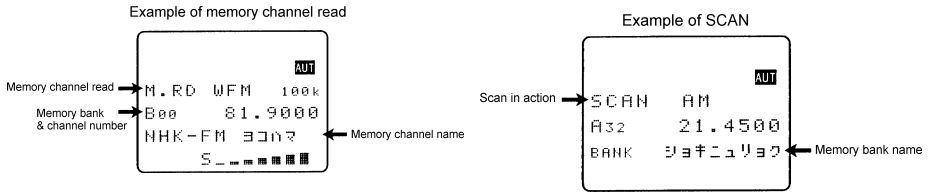

2-2 Connect the aerial (antenna)

Two aerials are supplied with the AR8200:

- BNC mounted whip aerial
- MW bar aerial

For general reception on the VHF/UHF bands, connect the supplied whip aerial to the BNC socket on the top panel of AR8200. This is a bayonet connector, line up the slots, press down firmly and twist clockwise, the guides will position, then let go. A different aerial can easily be fitted once you have established that the AR8200 is operating correctly and you are familiar with operation.

If you wish to monitor MW (Medium Wave bands), plug in the MW bar aerial. The MW slot on the top panel is protected by a sliding door to keep out dust and rain. A cut-out on the rear edge of the top panel enables the sliding door to be easily 'swept' open using a fingertip or thumb. Another cut-out toward the centre of the top panel enables the sliding door to be easily 'swept' closed... **No force is required !**

The MW bar is asymmetrical. With the longer arm of the MW bar facing to the right (grooves to the front) locate the MW connector into the socket and push into place. The force required to engage the MW aeralis is quite small, about the same as you would use to ensure the **PWR** key is

pressed with a positive result. If you really press very hard, it is possible to force the connector in backwards... the MW aerial will not operate if connected backwards.

Remember to close the MW slide door when the MW bar aerial is not in use.

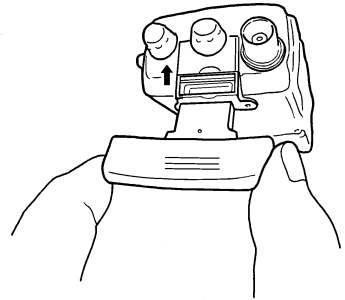
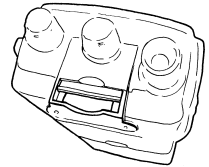
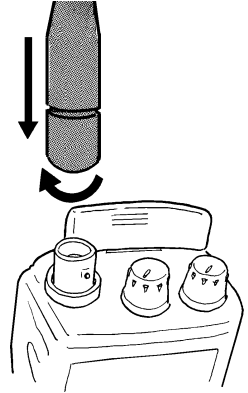
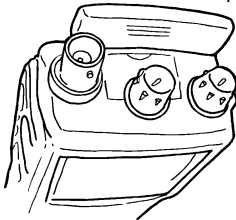



2-3 Fit the batteries

Fit the NiCad cells or dry batteries to the AR8200 as detailed in **section 1-6-1** of this manual. Alternatively the charger may be connected to the 12V d.c. socket of the AR8200 (however, do not connect external power if dry batteries are fitted).

2-4 Keypad and knobs... what you need to know 'most'



Several of the keys have special characteristics, a summary was given in **section 1-5-1** of this manual where it was explained that several keys have two of three functions associated with them.

 **IMPORTANT Note:** Make sure you understand the PASS (LOCKOUT / SKIP) operation before using the PASS facility, this applies to the PROTECT facility too, make sure both facilities are understood *before* you attempt to use them.

The list presented here represents 'what you need to remember most' ! Refer to **section 1-5-1 of this manual** for the definition of **PUSH**  and **PRESS**  should you not understand the syntax shown here.

2-4-1 ENTER key



Used as an ENTER key to accept data entry.



PRESS   to enter the current frequency in to memory (a quick memory facility is also available, explained **section 4-1** of this manual).

PUSH   **PUSH**   to access the text search menu.

2-4-2 FUNCTION key



The function (shift) key is used to select the second function of keypad facilities.

PUSH   to toggle the FUNCTION (shift) on/off. An solid reverse legend LCD "**FUNC**" indicates when function shift is in operation. The function status is terminated automatically in the normal course of entry.



PRESS   to initiate double-shift which is used in certain menus as a short-cut. The reverse "**FUNC**" legend flashes when double-shift is engaged.

2-4-3 PASS key





This key needs special attention as it acts as select ON/OFF/DEFAULT toggle in various menus.



PUSH   key to PASS (lockout) memory channels during memory read & scan mode and to PASS (lockout / skip) unwanted frequencies in search mode.



PRESS   in 2VFO mode to access the VFO PASS menu which extends to include the SEARCH bank pass edit menu.

PUSH   **PRESS**  in 2VFO, SEARCH or SCAN mode to access the SELECT SCAN edit menu.



2-4-4  **CLEAR key**

PUSH   to abort entry via the keypad... if in doubt, PUSH   to return to the previous display menu or operating mode.

PRESS   to select an option when an optional SLOT CARD is used.

PRESS  and hold the  key while powering on the AR8200 to soft reset the microprocessor should the AR8200 appear to behave strangely... no memory contents will be lost.



2-4-5  **MONITOR key**



The MONITOR key is used to force the squelch open to manually intervene ensuring that no weak signals are missed. PRESS  and hold the  key to defeat the squelch control (saves turning the squelch control fully anti-clockwise then back to threshold position).

When the “DUP” legend is displayed during frequency offset or VFO SCAN (DUPLEX) operation, the  key forces the AR8200 to switch to the alternative frequency.

In SCOPE mode, the  key enables the reception of the marker frequency.

2-4-6  **K.L. KEY LOCK**

The KEY LOCK is intentionally small to reduce the chances of accidental operation. Key lock is useful when you do not wish an important frequency to be lost or the AR8200 to be incorrectly set to a different frequency. The key lock status is not deactivated by switch off / on, the  and  keys are not affected by key lock.

PRESS   K.L. to toggle the key lock on / off, an LCD key symbol “” indicates status.

(3) Basic manual operation of the receiver

The following information explains how to tune to a specific frequency, change receive mode etc.



 **Note:** When the AR8200 is switched OFF, all VFO data will be automatically stored into flash-ROM memory storage. No battery or capacitor is required for memory backup. Should the NiCad cells (or dry batteries if in use) become completely exhausted, the last stored memory channel or last VFO data 'may' be lost.

CURSOR

The CURSOR may apparently 'go to sleep' at times when menus are called. This is because of the many tasks called by the microprocessor, it is simply doing something else at the time you call it. This is particularly noticeable when recalling memory banks when only a few channels have been stored.

3-1 Switching On



Set the squelch control to the 12 o'clock position and rotate the volume control to the 12 o'clock position.



PRESS  and hold the  key until the AR8200 powers up. It is never a good idea to switch on any receiver with an earphone connected, there may be an audible click when the unit is switched on or the volume may be accidentally set uncomfortably high.



In the default state, the LCD will show the opening message "**WELCOME TO THE NEW WORLD OF AR8200**" across the first four lines, at the same time the microprocessor generates the 'boot up data' required to control the receiver.

In normal use, the squelch control should be rotated clockwise until the background noise is *just* cancelled, this is known as '**threshold**' and is the most sensitive setting for the squelch control. Do not rotate the control too far clockwise or only the stronger local signals will be heard. If you find setting the squelch control difficult, try removing the aerial from the receiver.



Should you encounter problems in setting the volume level, PRESS  the  key on the left hand panel to momentarily defeat (open) the squelch so that a comfortable volume level may be set.

It is best to PUSH  the  key at this time to place the AR8200 in a known state of operation. The condition of "VFO" (1VFO) or "2VFO" is generally referred to as **manual mode**. The "2VFO" legend will be displayed in the upper left of the LCD to confirm selection.

 **Note:** If the AR8200 has no data input via the keypad or other controls for 90 seconds, some menus will time out and the AR8200 will return to its previous task just as if the  key had been operated.

3-2 2VFO twin VFO selection

The AR8200 receiver has a **twin VFO system** being identified as "**V-A**" and "**V-B**" on the LCD to the left of the frequency readout. The term VFO historically means '**Variable Frequency Oscillator**' and today refers to a tuneable data store which contains frequency, mode, step, step-adjust, attenuator etc.

Both VFO frequencies are displayed in parallel format on the LCD, one above the other. The '**active**' VFO (the one which is currently receiving) is displayed using a large font centrally on the LCD, the '**standby**' VFO is shown on a lower line using a smaller font size.

Example of 2VFO

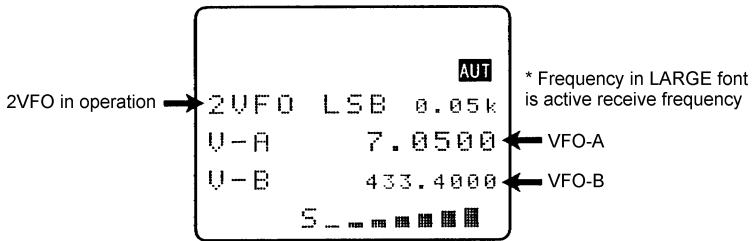

PUSH the **(2VFO)** key to first select '**VFO mode**' (should the receiver be scanning or searching etc).

Each time the **(2VFO)** key is pushed VFO "**V-A**" and VFO "**V-B**" alternate between active and standby.

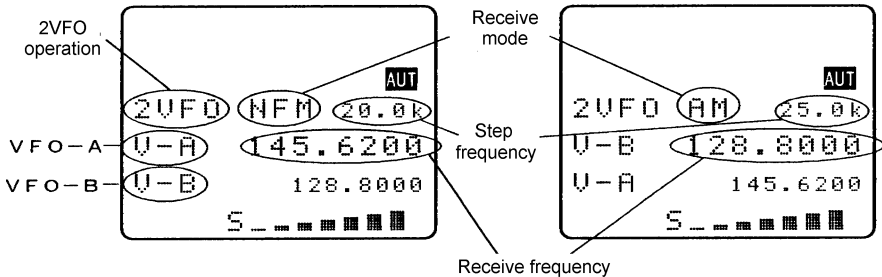

(2VFO) PUSH to change between VFO-A and VFO-B

The first time you enter a frequency via the numeric keypad, it is best to PUSH the **(2VFO)** key to

place the receiver in a known state of operation. PUSH the **(2VFO)** key so the "**V-A**" becomes the active VFO (upper and largest of the two frequency readouts). This condition is referred to as '**2VFO**' mode with VFO-A active and VFO-B as standby. If you find the twin frequency display confusing,

PUSH **(SRCH)** PUSH **(ENT)** or use the key sequence PUSH **(SCAN)** PUSH **(ENT)**

(while no signal is present) so that only a single frequency readout is displayed, this is referred to as '**1VFO**' mode. Both 1VFO and 2VFO modes may be referred to simply as VFO mode or **manual mode**.

Example of '1VFO' operation

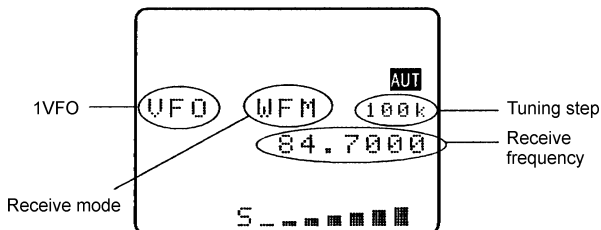

Transfer to active VFO

When the AR8200 has stopped on an active frequency in memory read, scan or search mode, use the key sequence **PUSH** **F** **PUSH** **2VFO** to transfer the frequency to the active (upper VFO). The AR8200 will revert to 2VFO mode where the frequency may be monitored.

3-3 Entering a frequency using the numeric keypad

While in VFO mode, enter the required frequency using MHz format followed by **ENT**.

Example of frequency entry 80.8 MHz

PUSH **8 HR** **PUSH** **0 JT** **PUSH** **Aa** **PUSH** **8 HR** **PUSH** **ENT**

There is no need to key in the trailing zeros to the right of the decimal point as they are automatically added by the microprocessor.

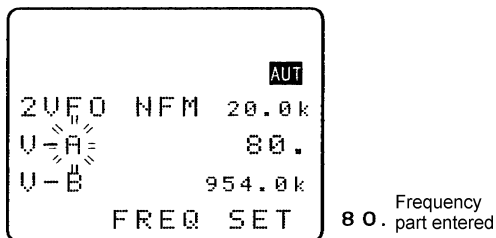

If keying in a whole MHz such as 118.000 MHz there is no need to key in either the decimal point or trailing zeros, they are all added by the AR8200 microprocessor.

Example of 'MHz round number' frequency entry for 808.000 MHz

PUSH **8 HR** **PUSH** **0 JT** **PUSH** **8 HR** **PUSH** **ENT**

While keying in frequency data, the bottom line of the LCD displays "FREQ SET" to indicate what sort of data input the AR8200 is expecting. Similar helpful messages are displayed at other times during data input.

Example of frequency entry 954 kHz (0.954 MHz)

PUSH **Aa** **PUSH** **9 IS** **PUSH** **5 EO** **PUSH** **4 DN** **PUSH** **ENT**

The frequency of 954 kHz is equivalent to 0.954 MHz. When entering frequencies below 1 MHz, there is no need to proceed the decimal point with a zero as this is added by the microprocessor during frequency entry then removed when the **ENT** key is pushed to ensure the display appears neat and tidy.

You will note that frequencies below 3.0 MHz (3000 kHz) will be automatically displayed in kiloHertz format (the letter "k" will be displayed to the right of the frequency readout) and the decimal point

displayed to the right of the kHz position. This is to ensure easy recognition of short wave frequencies which are often listed as 'kHz' in frequency guides.

If an attempt is made to enter an 'out of range' or invalid frequency (such as 2345 MHz or 0.09 MHz) the error beep will sound (if beep is enabled) and the LCD returns to the previous frequency prior to frequency input. **Acceptable input range is 0.1 MHz to 2040 MHz.**

 **Note:** If you pause during frequency input for more than 90 seconds, the menu will time out and the AR8200 will return to its previous task just as if the **(CLEAR)** key had been operated.







Aborting frequency input

If for some reason you do not wish to complete the frequency data input, **PUSH**  **(CLEAR)** before completing the input sequence with **(ENT)**.

3-4 Correcting frequency input

Should an error be made while entering frequency data (by pressing the wrong numeric key), it may be corrected using the ⇐ BACKSPACE facility. This facility enables rapid correction of errors prior to the completion of entry by the enter key.

Example of frequency data correction while keying 433.250 MHz

PUSH  **(4 DN)** **PUSH**  **(3 CM)** **PUSH**  **(3 CM)** **PUSH**  **(● Aa)** **PUSH**  **(2 BL)**
then PUSH  **(7 GQ)** (as if you have made a mistake)

PUSH  ⇐, the number "7" clears from the LCD



PUSH  **(5 EO)** **PUSH**  **(ENT)** to finalise the correct entry.

3-5 Changing frequency using the ↑ and ↓ keys

The ↑ and ↓ keys provide a convenient method of frequency change.

The speed at which the receiver steps up or down depends upon the STEP SIZE which is default to AUTO. In AUTO the step size, receiver mode etc is taken from the factory pre-programmed band plan but may be overridden at any time.

Examples of tuning step include: 0.05 kHz (50 Hz), 0.1 kHz (100 Hz), 0.2 kHz (200 Hz), 0.5 kHz (500 Hz), 1.00 kHz, 2.00 kHz, 5.00 kHz, 6.25 kHz, 8.33 kHz, 9.00 kHz, 10.00 kHz, 12.50 kHz, 20 kHz, 25.00 kHz, 30 kHz, 50 kHz, 100.00 kHz. **The tuning step size may also be programmed in multiples of 50 Hz** (via the keypad) so that unusual step sizes other than stated are possible.

PUSH  the ↑ key to tune the receiver upward in whichever step size is selected, use the ↓ to tune the receiver downward in frequency. You may **PRESS**  **and hold** either key to continuously tune the receiver in whichever direction is desired, tuning will stop when the key is released.

Note: In AM and FM modes with the squelch open, reception will be momentarily interrupted while tuning and the “S” squelch legend will flash as tuning progresses, a ‘chuff-chuff’ sound will accompany tuning, this is normal.

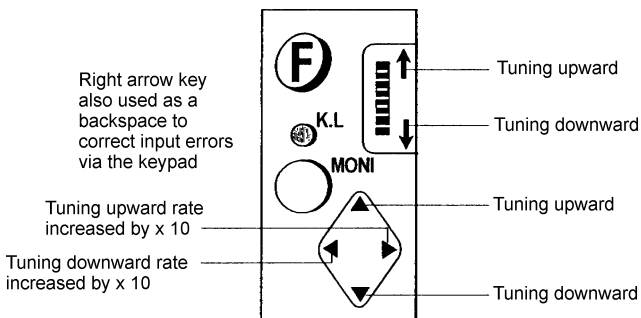

Fast tuning

The ⇐ and ⇒ keys may be used to tune the receiver at a rate TEN TIMES FASTER than the selected step size. This means that when a step size of 25 kHz is selected, tuning will be in 250 kHz steps, this provides a convenient method to quickly tune up and down frequency bands.

Note: Be aware that when auto-mode is selected and a tuning step change has automatically taken place, one PUSH up or down may take several pushes to arrive back to the starting place again.

1 MHz tuning

While the “FUNC” legend is displayed (achieved by a PUSH of the (F) key, PUSH again to deactivate as a toggle), the tuning rate for the ↑ and ↓ keys is 1 MHz per increment.

3-6 Changing frequency using the main dial

While in VFO mode, the active VFO frequency may be ‘tuned’ in a similar way to a domestic receiver or other specialist receivers using the rotary tuning **main dial** which is mounted on the left hand side of the cabinet. This is best controlled using the thumb of you left hand (with the set held in your left hand), it may also be tuned using the middle finger of your right hand or in whatever way you find comfortable.

This method of frequency selection is the most traditional approach to locating signals particularly on the short wave and medium wave bands. It provides an easy method to locate new or previously unknown frequencies or to check activity within certain frequency bands such as amateur or short wave broadcast. The rotary tuning main dial provides the very best ‘user interface’ with the AR8200 especially for USB, LSB and CW listening.

Rotating the main dial ‘upward’ increases frequency while rotation ‘downward’ decreases receive frequency.

The speed at which the main dial tunes the receiver depends upon the STEP SIZE which is default to AUTO. Examples of tuning step include: 0.05 kHz (50 Hz), 0.1 kHz (100 Hz), 0.2 kHz (200 Hz), 0.5 kHz (500 Hz), 1.00 kHz, 2.00 kHz, 5.00 kHz, 6.25 kHz, 8.33 kHz, 9.00 kHz, 10.00 kHz, 12.50 kHz, 20 kHz, 25.00 kHz, 30 kHz, 50 kHz, 100.00 kHz. The tuning step size may also be programmed in multiples of 50 Hz (via the keypad) so that unusual step sizes other than stated are possible.

While the “FUNC” legend is displayed (achieved by a PUSH of the (F) key, PUSH again to deactivate as a toggle), the tuning rate for the main dial is TEN TIMES FASTER than the selected step size. This means that when a step size of 10 kHz is selected, tuning will be in 100 kHz steps, this provides a convenient method to quickly tune up and down frequency bands.

3-7 Changing receive mode

Due to the necessities of signal bandwidth, channel occupancy and transmission efficiency, different receive modes are used by various services. In addition to this the specification for tuning step and receive mode are allocated by departments of Governments following International discussions so are not consistent throughout the world. For this reason, it is necessary to change receive mode in order to monitor various transmissions.



For your convenience, receive mode and tuning step size have been pre-programmed into the AR8200 auto-mode bandplan data at the factory to simplify operation of the receiver, especially while you familiarise yourself with all the facilities. Should you wish, the defaults may be manually over-ridden at any time so that you may select an alternative receive mode and tuning step on any frequency.

3-7-1 Auto-mode selection

When auto-mode is in operation (so that receive mode and tuning step size are automatically selected for you by the AR8200 microprocessor), the reverse legend "AUT" is displayed toward the top right of the LCD.

To activate auto-mode or reconfirm its selection while in VFO mode,

PUSH  (F) PRESS  (3 CM)

Alternatively "AUTO" may be selected from the "MODE SET" menu accessed with the key sequence PUSH  (F) PUSH  (3 CM).

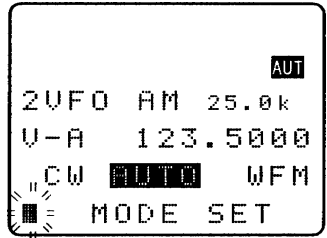
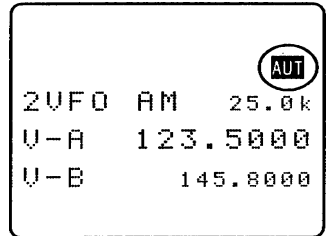

The (PASS) key acts as a short cut to "AUTO", alternatively use the main dial or ⇄ ⇄ keys. When the reverse "AUTO" legend has been selected, PUSH  (ENT) to accept the data input. The LCD will revert to VFO mode with the "AUT" legend confirming selection.



 **Note:** Auto-mode is cancelled as soon as the receive mode, tuning step or other related data is changed. Remember that auto-STEP and auto-MODE are linked, reselect AUTO-MODE if either have been adjusted and you require the auto bandplan selection.

3-7-2 Receive mode selection menu

Any receive mode may be selected at any frequency within the receiver's frequency coverage.

To access the receive mode menu PUSH  (F) PUSH  (3 CM), the following modes are available: AUTO, WFM, NFM, SFM, WAM, AM, SAM, USB, LSB, CW. Use the main dial or ⇄ ⇄ ↑ ↓ keys to make selection, the (PASS) key acts as a short cut to "AUTO". To accept the selection PUSH  (ENT).

As a further short cut to AUTO MODE, PUSH  (F) PRESS  (3 CM). The reverse LCD legend "AUT" confirms selection.

Generally speaking the following modes will apply:

AUTO

Receive mode and tuning step will be selected automatically using the pre-programmed auto bandplan data.

WFM

Wide band Frequency Modulation - used by VHF and UHF broadcast stations as excellent audio quality is available due to the relatively wide frequency bandwidth employed. Used only for local services such as VHF Band-II stereo (received as mono on the AR8200) and UHF TV sound channels.

When listening in VERY strong signal locations especially when using an external aerial, adjacent channel interference may be observed due to the wide nature of the IF filters. Should interference be encountered, use the attenuator to reduce signal strength or swap to the standard semi-flexible whip aerial.

NFM

Narrow band Frequency Modulation - this provides high quality communication for relatively short distance operation. NFM uses a greater frequency bandwidth than other point-to-point modes such as SSB so is less efficient.

NFM is the most common mode used above 30 MHz with the exception of the airbands (which use AM). NFM is widely used on the VHF bands: VHF Marine band, 2m amateur Band (145MHz), 70cm amateur band (433 MHz), PMR (Private Mobile Radio) and utilities.

In the absence of a signal, the background white noise may appear quite loud. For ease of listening the squelch control should be rotated clockwise until the background noise just disappears, this should be carried out when no signal is present. The point where the background noise is cancelled is known as 'threshold point'. Do not advance the squelch control more than necessary or the receiver will appear to be desensitised and weaker signals will be missed.

SFM

Super Narrow band Frequency Modulation - this mode is specific to the AR8200. Essentially this is the same mode as NFM but uses a narrower IF filter for added selectivity when monitoring crowded bands such as PMR utilities.

WAM

Wide Amplitude Modulation - this mode is specific to the AR8200. It is essentially the same as AM but uses a wider IF filter, particularly useful for monitoring parasitic airband transmissions when 'repeater transmissions' are employed. Provides good broadcast quality for MW (medium wave band) listening to strong local signals when adjacent channel transmissions are not encountered.

AM

Amplitude Modulation - Used by broadcast services throughout the world on medium wave and short wave. AM is also used by VHF civil airband, UHF military airband and some PMR (Private Mobile Radio) and utility services.

NAM

Narrow Amplitude Modulation - this mode is specific to the AR8200. It is essentially the same as AM but uses a narrower IF filter for added selectivity when monitoring crowded bands such as short wave. Due to the narrower bandwidth employed, the audio quality will be compromised.

USB

Upper Side Band - is a form of Single Side Band (SSB). USB is used commercially and by radio amateurs on frequencies above 10 MHz (below 10 MHz radio amateurs tend to use LSB to assist the separation of commercial and amateur users on traditionally shared bands, this prevents them from attempting to communicate with each other... which is prohibited).

All long range shipping and oceanic air traffic (as well as long range military aircraft) use USB. DATA modes such as RTTY, SITOR, PACKET, FAX etc may be resolved using USB.

SSB is a very efficient method of transmission as the unwanted second sideband and carrier have been removed. This allows the full transmitter power to be employed in conveying useful information within the wanted sideband. As a result, greater distances are possible on SSB with a smaller frequency bandwidth being required than most other receive modes.

The AR8200 uses true carrier re-insertion and a dedicated SSB I.F. filter so that voice becomes intelligible. However due to the complexities of SSB, audio never sounds 100% natural, like all SSB-equipped receivers, the AR8200 may sound a little 'robotic' but you soon get used to SSB receivers. Small tuning steps of 50 Hz or 100 Hz should be used for tuning in USB and the other similar modes LSB & CW.

The AR8200 being a hand held wide band receiver cannot offer the receive performance of a dedicated short wave receiver such as the AOR AR7030 or base wide band receiver AOR AR5000. This is due to the limitation of size, as a result the receiver's AGC (Automatic Gain Control) circuitry band pass circuits and reference stability cannot be as complex. The AR8200 will however provide adequate results for oceanic, ship to shore and amateur band listening etc.

The SSB frequency display is not offset (like some other units), this is good for referencing to frequency booklets and data bases. However being such a compact wide band receiver, it will not be unusual for the SSB display to be a few hundred Hz off frequency when listening to known frequencies such as VOLMET (airband weather forecast service). For example the European 5.5050 MHz VOLMET service may appear between approximately 5.5045 and 5.5055 MHz... this is considered normal.

LSB

Lower Side Band - The same comments apply as for USB. By convention, radio amateurs use LSB below 10 MHz.

CW

Continuous Wave - Often referred to a Carrier Wave or Morse code 'dots and dashes'. Commonly used on the short wave bands by radio amateurs toward the lower end of each band allocation. Some commercial use is still made by shipping etc although its use is being phased out due to the introduction of automated stations.

3-8 Changing tuning STEP size

The specification for channel occupancy, step (separation) and mode are decided by and allocated by departments of Governments following International discussions.

Not surprisingly the allocation of frequency bands are not the same all over the world and channel separation (step) varies from band to band. As an example, the channel separation (step) for the medium wave band in Europe is 9 kHz while in the U.S.A. it is 10 kHz.

For the above reasons it is necessary to alter the STEP size according to local bandplan conventions. The AR8200 has been pre-programmed at the factory with all the bandplan data (specific to each market area) so that the AR8200 will automatically select the appropriate step size and mode for the frequency chosen. This greatly simplifies operation of the receiver while you are familiarising yourself with all the facilities.

The pre-programming of step size may be manually over-ridden so you may choose alternative settings at will or when band plans are updated.

Should you wish to change the default tuning step size **PUSH** (F) **PUSH** (2 BL)

The third main text line of the LCD will display the current default size (perhaps "25.00" kHz). If the reverse LCD legend "AUT" displayed in the upper right corner of the LCD, this indicates that AUTO MODE / STEP is currently selected.

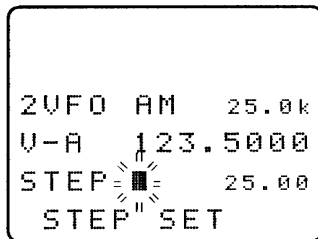

The bottom line of the LCD displays the legend "STEP SET" to indicate that the AR8200 is inviting you to change the step size.

Use the main dial or ← and → keys to select the required step size. The list is as follows: 0.05 kHz (50 Hz), 0.1 kHz (100 Hz), 0.2 kHz (200 Hz), 0.5 kHz (500 Hz), 1.00 kHz, 2.00 kHz, 5.00 kHz, 6.25 kHz, 8.33 kHz, 9.00 kHz, 10.00 kHz, 12.50 kHz, 20 kHz, 25.00 kHz, 30 kHz, 50 kHz, 100.00 kHz.

To accept the displayed tuning step size **PUSH** (ENT), the LCD will revert to its previous display.

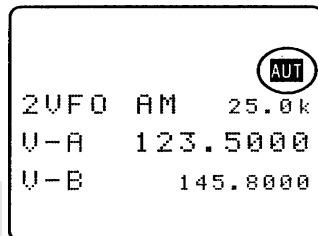

Note: The frequency step of 8.33 kHz has been included for compliance with the new VHF airband allocation, it has been correctly implemented as eight-and-one-third kHz so that no compound error arises (i.e. the last digits display 33, 66, 00).

The tuning step size may also be programmed in multiples of 50 Hz (via the keypad) so that unusual step sizes other than stated are possible. The acceptable step size range is 0.05 kHz (50 Hz) to 999.95 kHz in 50 Hz steps.

When the desired step size has been entered, **PUSH** (ENT) to accept the new step size. If you attempt to input an invalid step size, the error beep will sound (presuming that the beep facility is enabled) and the incorrect input will be ignored.

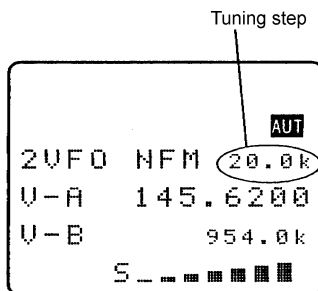

*** Active frequency must be divisible by step size ***

There is just one small point to bare in mind, the active frequency must be divisible by the step size... in 99% of cases they will be. However, should you start experimenting with different step sizes you may notice the active frequency change automatically to the nearest multiple of step size as the AR8200 calculates automatically for you, there is no need to carry a calculator!

For example, select 118.000 MHz then select a 9 kHz step size:

PUSH (1 AK) **PUSH** (1 AK) **PUSH** (8 HR) **PUSH** (ENT)
PUSH (F) **PUSH** (2 BL) choose "9.00" using the main dial then **PUSH** (ENT)

The receive frequency will currently be displayed as 118.000 MHz but once the main dial has been used, the displayed frequency will be corrected to 117.9990 or 118.0080 MHz (depending upon the direction of tuning) both of which are the closest multiple of 9 kHz to 118 MHz.

The display doesn't correct immediately upon frequency entry to allow you to enter the 'STEP-ADJUST' menu to change the step size and step-adjust in order to help track unusual band plans.

 **Note:** **AUTO-STEP, STEP-ADJUST and AUTO-MODE are linked** to the pre-programmed bandplan data. When one of the parameters is changed from the default "AUTO" the bandplan will be ignored.

To re-instate AUTO step size, the receive MODE must be returned to "AUTO" using the "MODE SET" menu or by using the key sequence **PUSH**  **F** **PRESS** 

3-9 STEP-adjust

The AR8200 provides a powerful feature to enable accurate following of unusual band plans. When active, the "ADJ" legend is displayed top-centre of the LCD.

Step-adjust is used when the receiving frequency is not divisible by the step size in use (It is possible that step-adjust has been programmed into the auto-mode bandplan data for some world market areas). Therefore step-adjust is useful for certain band plans such as cellular which in some areas starts as 917.0125 MHz then increments in 25 kHz steps. Another example is the CB allocation in certain areas which starts at 27.60125 MHz then increments in 10 kHz steps. Often just a HALF STEP is required but more exotic band plans can be tracked.

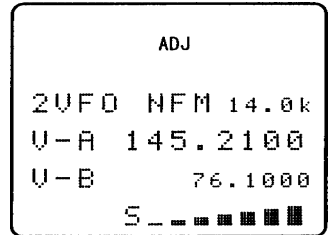

Step-adjust may be factory pre-programmed into the bandplan data (you may over-ride this). It is also possible to store the step-adjust data into memory channels and search banks.

3-9-1 Automatic calculation of step adjust

The AR8200 can calculate the required step-adjust, simplifying its use.

Example 1: Assume that you wish to tune from 148.010 MHz in 20 kHz steps (i.e. 148.010, 148.030, 148.050, 148.070, 148.090 etc). When manually tuning, the AR8200 would normally correct the frequency display to read 148.020 then step upward in 20 kHz steps. Tuning back downward will skip 148.010 MHz (the starting point) as the original frequency was not divisible by step size... **it was offset by +10 kHz.** Usually the frequency must be divisible by the tuning step size. However, the STEP-ADJUST facility is used to address this situation.

Example: Apply a 10 kHz step adjust for a frequency tuned in 20 kHz steps

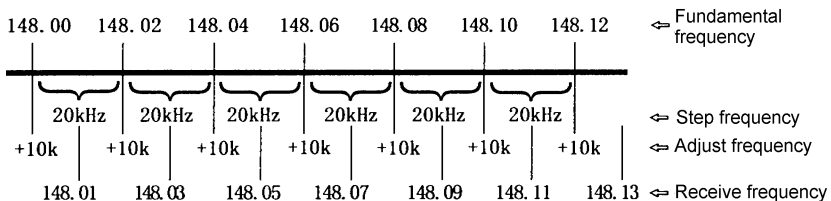

With the above example of 148.010 MHz with 20 kHz steps in mind, while in VFO mode, key in the start frequency of 148.010 MHz

PUSH (1 AK) PUSH (4 DN) PUSH (8 HR) PUSH (Aa) PUSH (0 JT)
 PUSH (1 AK) PUSH (ENT)

Access the STEP menu using the key sequence PUSH (F) PUSH (2 BL). Use the main dial to select a step size of 20 kHz (do NOT press enter!).

PUSH (PASS) to access the STEP-ADJUST menu.

Accessing this menu will activate the step-adjust facility, the "ADJ" legend will be displayed on the LCD to confirm selection. You will note that the calculated step adjust value is displayed on the bottom of the LCD as "ADJ+ 10.00" representing a positive offset of +10 kHz with a step size of 20 kHz. PUSH (ENT) to accept the displayed data.

The display will return to VFO mode with 148.010 MHz displayed. The main dial will now correctly follow the required bandplan.

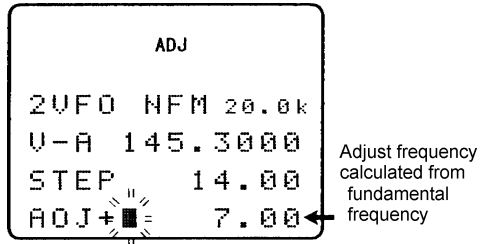
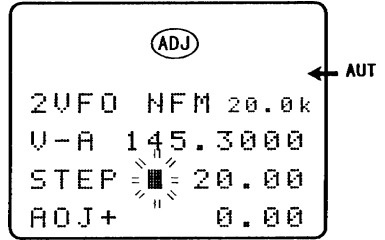

3-9-2 Cancelling step-adjust

There are two ways to cancel step-adjust

1. Access the STEP menu. PUSH (F) PUSH (2 BL), the step-adjust data will be immediately displayed along with step size. PUSH (PASS) to remove the step-adjust data from the display, the "ADJ" legend will be removed from the LCD. PUSH (ENT) to accept the changes. Step-adjust will be cancelled.
2. Presuming that you have manually selected step-adjust (step-adjust has not been set by the auto-mode bandplan), re-select AUTO-MODE which will reinstate the auto-mode step size, step-adjust, frequency offset and receive mode. PUSH (F) PRESS (3 CM). The "ADJ" legend will be removed from the LCD and the auto-mode "AUT" legend will be displayed.

3-9-3 Manual setting of step-adjust

The AR200 usually correctly 'guesses' what step-adjust you require, often this is a half step but manual intervention is possible!

Example 2: Assume that you wish to tune from 58.445 MHz in 15 kHz steps (i.e. 58.445, 58.460, 58.475, 58.490, 58.505 etc). When manually tuning, the AR200 would normally correct the frequency display to read 58.455 then step upward in 15 kHz steps. Tuning back downward will skip 58.445 MHz (the starting point) as the original frequency was not divisible by step size... it was offset by +5 kHz. Usually the frequency must be divisible by the tuning step size.

However, the STEP-ADJUST facility is used to address this situation.

Example: Apply a 5 kHz step adjust for a frequency tuned in 15 kHz steps

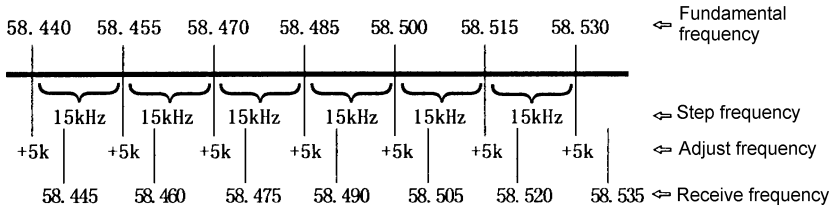

With the above in mind, 58.445 MHz with 15 kHz steps in mind, while in VFO mode, key in the start frequency of 58.445 MHz

PUSH (5 EO) PUSH (8 HR) PUSH (Aa) PUSH (4 DN) PUSH (4 DN)
 PUSH (5 EO) PUSH (ENT)

Access the STEP menu using the key sequence PUSH (F) PUSH (2 BL). 15 kHz is not a standard size provided by rotating the main dial so key in the required 15 kHz step size.

PUSH (1 AK) PUSH (5 EO) (do NOT press enter!). PUSH (PASS) to access the STEP-ADJUST menu. Accessing this menu will activate the step-adjust facility, the "ADJ" legend will be displayed on the bottom of the LCD as "ADJ+ 7.50" representing a positive offset of +7.5 kHz with a step size of 15 kHz... the AR8200 often assumes that you require a half step. However when looking at the

requirement the required offset is actually 5 kHz. PUSH (↓) to move the cursor to the step-adjust (bottom) line. Use the main dial to select 5.00 kHz (or key in 5 kHz PUSH (5 EO)).

PUSH (ENT) to accept the displayed data. The display will return to VFO mode with 58.445 MHz displayed. The main dial will now correctly follow the required bandplan.

Manual intervention is not always required

Note: The AR8200 is not all that dumb really, in the above example, as soon as you pressed the (ENT) key the CPU realised that a half step was not appropriate so would have selected an offset of 5 kHz automatically! Try it and see, just PUSH (ENT) while it displays 7.50 kHz - yes, it works! Access the step menu to review the figures, they will show a step size of 15 kHz and step-adjust of 5 kHz... clever!

Example 3: This example shows just how bizarre the bandplan can be. Assume that you wish to tune from 145.210 MHz in 14 kHz steps (i.e. 145.210, 145.224, 145.238, 145.252, 145.266 etc). When manually tuning, the AR8200 would normally correct the frequency display to read 145.236 then step upward in 14 kHz steps. Tuning back downward will skip 145.210 MHz (the starting point) as the original frequency was not divisible by step size.

With this example of 145.210 MHz with 14 kHz steps in mind, while in VFO mode, key in the start frequency of 145.210 MHz

PUSH (1 AK) PUSH (4 DN) PUSH (5 EO) PUSH (● Aa) PUSH (2 BL)
PUSH (1 AK) PUSH (ENT)

Access the STEP menu using the key sequence PUSH (F) PUSH (2 BL). 14 kHz is not a standard size provided by rotating the main dial so key in the required 15 kHz step size.

PUSH (1 AK) PUSH (4 DN) (do NOT press enter!).

PUSH (PASS) to access the STEP-ADJUST menu. Ignore the step-adjust value displayed (10 kHz),

PUSH (ENT) to let the AR8200 automatically calculate the requirement, you will need to

PUSH (ENT) a second time to exit the menu and return to frequency display.

The frequency of 145.210 MHz will be displayed and the main dial will now correctly follow the required bandplan, 14 kHz steps 145.224, 145.238 MHz etc. For your information, the required step-adjust was 2 kHz. If you wish, access the step menu to review the figures, they will show a step size of 14 kHz and step-adjust of 2 kHz... right again!

3-10 FREQUENCY OFFSET

This facility enables receive frequency to be quickly SHIFTED (two key presses) by a pre-determined value, this makes it easy to track duplex-transmissions or check repeater inputs / outputs. Offset frequencies may be factory pre-programmed into the auto-mode bandplan data for some world market areas. Frequency offset may also be programmed manually.

The locations for frequency offset storage are numbered 00 to 47 with 00 acting as OFF, this makes 47 locations available. Locations 01 to 19 may be programmed by the operator while locations 20 to 47 are reserved for factory programming (used by the auto bandplan data). Look at locations 20 to 47 for common offsets, they may already be stored.

Frequency offset may be programmed into VFO, memory channel and search banks. It is most convenient to set-up in VFO mode then save the data to specific memory channels for quick recall at a later date. Frequency offset is primarily designed for memory channel use, it may appear rather long winded to toggle on/off in VFO mode. However even when programmed, frequency offset is in no way detrimental to normal operation.

The acceptable range of frequency offset is 0 MHz to 999.99 MHz, of course if the offset is set to 0 MHz, the frequency will not change! Before the FREQUENCY OFFSET facility can be used, it first needs to be configured (unless factory programmed for certain bands).

3-10-1 Using pre-programmed frequency offset data

To access the frequency offset set-up menu PUSH (F) PUSH (● Aa)

The third line will display "OFFSET 00" with "00" indicating that frequency offset is currently off, there will be no "DUP" legend displayed when the frequency offset is OFF. The bottom line of LCD will display "- - - - -" indicating that no offset is stored. Use the main dial or $\leftarrow \rightarrow$ keys to review the offset locations, particularly numbers 20 to 47 where useful factory programmed offsets may be stored. As soon as you shift from location 00, the "DUP" duplex legend is displayed on the LCD to indicate that frequency offset is in use.

Offset + or -

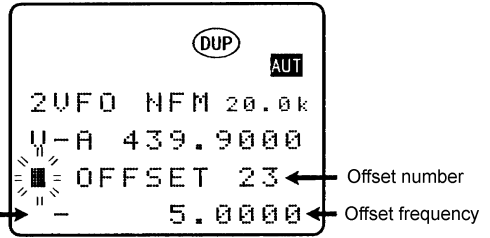

Presuming that data is already programmed into an offset location, PUSH \leftarrow the (PASS) key to toggle offset between "+" positive and "-" negative offset, this is a **global toggle** and affects ALL frequency offset channels (but not those already stored into memory or search banks). To accept the offset setting, PUSH \leftarrow

(ENT). The LCD will revert to its operation prior to the frequency offset menu being called. The LCD legend "DUP" will be displayed to indicate that frequency offset has been activated.

To use the frequency offset PRESS \leftarrow \bigcirc MONI, the LCD frequency will alter to take account of the offset 'value & direction' and the squelch will be defeated. When you release the \bigcirc MONI key, the AR8200 will revert to the original frequency (and squelch will close if no signal is present).

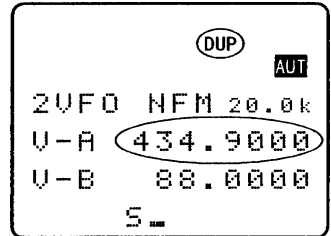
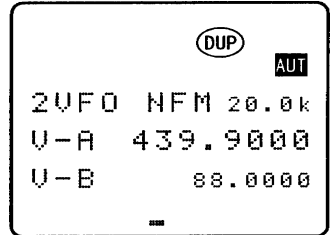

Note: Each VFO, memory channel and search bank can be programmed with a different frequency offset. If different channels and offsets have been programmed to VFOs etc, the key sequence PUSH \leftarrow (F) PUSH \leftarrow (Aa) will recall the specific offset location originally used during programming, this is particularly useful when you simply wish to toggle the + / - offset.

To cancel the frequency offset, access the frequency offset menu and select location "00", the "DUP" legend will be removed from the LCD.

3-10-2 Entering new frequency offset data

Assume that you are in VFO mode with a frequency of 433.000 MHz

To access the frequency offset set-up menu PUSH \leftarrow (F) PUSH \leftarrow (Aa)

The third line will display "OFFSET 00" with "00" if the frequency offset is currently off, there will be no "DUP" legend displayed when the frequency offset is OFF.

Use the main dial or $\leftarrow \rightarrow$ keys to select an unused frequency offset location between the numbers of 01 and 19 inclusive (00 being interpreted as off and 20 - 47 reserved for pre-programmed data).

For example, use the main dial until the LCD displays "**OFFSET 01**", the bottom line of LCD will display "----" indicating that no offset has been previously stored. If data is stored, the offset value will be displayed on the bottom line of the LCD and may be overridden.

Key in the desired offset in MHz format, the ⇐ key may be used as a backspace should an error be made. i.e. for an offset of +1.600 MHz PUSH ⇐ (1 AK) PUSH ⇐ (● Aa) PUSH ⇐ (6 FP) (don't push enter!) PUSH ⇐ the (PASS) key to toggle the frequency offset direction between "+" and "-" until the LCD shown "+" for positive offset. You may use the ↑ key to accept the frequency but stay in the menu (in case you haven't yet decided on the direction of offset), PUSH ⇐ (ENT) to accept the data input.

The LCD will revert to its operation prior to the frequency offset menu being called. The LCD legend "**DUP**" will be displayed to indicate that frequency offset has been activated.

To use the frequency offset PRESS 👉 ○^{MONI}, the LCD frequency of 433.000 MHz will alter to take account of the offset value and direction and the squelch will be defeated, the duplex frequency of 434.600 MHz (which is 1.600 MHz above the original frequency) will be displayed. When you release the ○^{MONI} key, the AR8200 will revert to the original frequency of 433.000 MHz (and squelch will close if no signal is present). You can access the frequency offset menu simply to change the direction of offset from "+" to "-" or vice-versa.

3-11 Attenuator

The attenuator adds 10dB of signal reduction to the RF input stages of the AR8200 to reduce the possible effects of strong signal overloading due to connection to an external aerial or when the receiver is used in close proximity to strong transmissions.

The AR8200 has two settings for ATT (attenuator), on and off. When the attenuator is ON, the legend "**ATT**" appears on upper left of the LCD.

To toggle the attenuator on/off PUSH ⇐ (F) PUSH ⇐ (1 AK), the legend "**ATT**" confirms selection and incoming signals will be reduced in strength. To toggle on/off again just repeat the sequence PUSH ⇐ (F) PUSH ⇐ (1 AK), the legend "**ATT**" is extinguished when the attenuator is OFF.

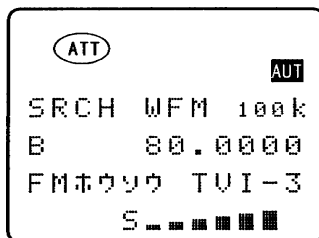





The selection of attenuator is held separately in each VFO, each memory channel and may also be toggled **during** search (in scan mode, the scanning process must be stopped in order to see which memory channel you are applying the attenuator to!).

3-12 Noise limiter

The noise limiter can help to reduce the effects of noise spikes and pulses while listening in AM and SSB modes (WAM, AM, NAM, USB, LSB, CW). The noise limiter may be toggled on/off in all receive modes but will only be operational in the AM and SSB modes, it will have no effect on WFM, NFM or SFM.

The noise limiter has two settings, on and off. When the noise limiter is ON, the legend "NL" appears on LCD.

To toggle the noise limiter on/off **PUSH**  **(F)** **PRESS**  **(1 AK)**, the legend "NL" confirms selection and the noise limiter will be active in AM and SSB modes. To toggle on/off again just repeat the sequence **PUSH**  **(F)** **PRESS**  **(1 AK)**, the legend "NL" is extinguished when the noise limiter is OFF.

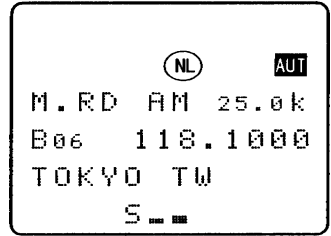

The selection of noise limiter is held separately in each VFO, each memory channel and may also be toggled during search (in scan mode, the scanning process must be stopped in order to see which memory channel you are applying the noise limiter to!).

3-13 AFC - Automatic Frequency Control

The AR8200 is equipped with AFC, this is useful when tracking unusual band plans or when the exact frequency is unknown... it ensures that the AR8200 is tuned to 'centre frequency' for best reception.





AFC is operational only in NFM, SFM, WAM, AM, NAM... AFC is not operational in WFM, USB, LSB, CW. If AFC has been activated and you select a mode not supported by AFC, the "AFC" legend will be extinguished from the LCD. Once AFC has been activated (say when you are monitoring NFM), it will temporarily be deactivated should you select WFM, USB, LSB, CW but will automatically be reactivated when NFM or other supported modes are again selected.

VALID = NFM, SFM, WAM, AM, NAM
INVALID = WFM, USB, LSB, CW

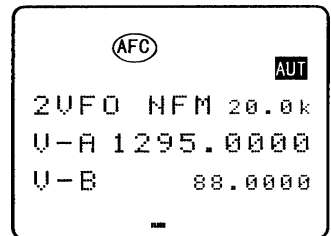
AFC has two settings, on and off. When AFC is ON, the legend "AFC" appears on LCD during reception using a supported receive mode.

 **Note:** Attempted operation while using an unsupported receive mode will result in the input being ignored, however the on/off toggle status will be incremented and implemented once a supported receive mode is selected (i.e. you can always toggle the AFC status on/off regardless of displayed mode).



To toggle AFC on/off **PUSH**  **(F)** **PUSH**  **(0 JT)**, the legend "AFC" confirms selection when a supported receive mode is in use. To toggle on/off again just repeat the sequence **PUSH**  **(F)** **PUSH**  **(0 JT)**, the legend "AFC" is extinguished when AFC is OFF and using a supported receive mode.

The selection of AFC is held separately in each VFO, each memory channel and may also be toggled during search (in scan mode, the scanning process must be stopped in order to see which memory channel you are applying the AFC to!).

AFC characteristics

When the AFC is active while monitoring a transmission using a supported receive mode, AFC will attempt to automatically 'pull' the AR8200 onto centre frequency for best reception.

The distance in kHz which the AR8200 can 'pull' depends upon receive mode, IF bandwidth and signal strength... the wider the filter and stronger the signal then the further AFC can pull.

Typically AFC will pull in the region of ± 5 kHz to ± 15 kHz, the maximum value for AFC is set to ± 25 kHz so that the receiver does not continually tune across the frequency spectrum looking for 'anything' to centre tune.

The AFC process usually takes a few seconds to 'settle down' after which time it is normal for the frequency display last couple of digits to flicker up and down in frequency... this looks like 'frequency drift' but fear not, the frequency tracking is under strict control! Typical accuracy of centre tuning is around 1.5 kHz. If no signal is present and the squelch is open, the last two digits will randomly flicker around. When the squelch closes in the absence of a signal, the last two digits will stop flickering but may display a frequency which does not strictly adhere to the bandplan. If you toggle AFC off, the frequency display will jump to the nearest increment for the frequency band (appropriate to the tuning step selected).

(4) VFO enhanced facilities

As well as providing a tuning data storage, the two VFOs offer additional features including quick memory, VFO scan, VFO search and VFO environment.



4-1 Quick memories

While monitoring in 2VFO mode, 10 'quick memories' are provided for easy saving of current VFO data and simple recall at a later time. When all 10 quick memories have been used and further data is stored, the oldest quick memory will be overwritten. Quick memory channels are not numbered, they simply form a chronological list which you may recall and scroll through.

Quick memories may also be written to automatically when using VFO SEARCH MODE. To activate AUTO QUICK MEMORY, the VFO environment parameters need to be first set up

The AR8200 provides 1,000 memory channels in addition to the 10 'quick memory' channels and a priority channel. Each 'quick memory' channel may hold all the data for the current VFO: frequency, mode, step, step-adjust, frequency offset, attenuator setting, noise limiter status & AFC status.

4-1-1 Saving quick memory data

If you are not already in 2VFO mode **PUSH**  **2VFO** so that the "2VFO" legend is displayed toward the upper left of the LCD. While in 2VFO mode, **PUSH**  the **ENT** key to save the current active VFO (upper of the two frequency displays with larger characters) into quick memory.

If the beep facility is active, a BEEP will be heard, if the beep facility is not active there will be no indication that quick memory storage has taken place (until you recall the data!).

Change the displayed frequency and save two or three further quick memory channels.

 **Note:** Frequencies must be more than ± 10 kHz from of a frequency already stored in quick memory or the new frequency will be ignored, this prevents all 10 quick memory channels needlessly containing the same frequency.

Saving quick memories while in VFO search

The quick memory facility is available in VFO SEARCH mode in addition to 2VFO mode. The procedure is just the same, **PUSH**  the **ENT** key while the receiver is monitoring a transmission to save the receive frequency and accompanying data to quick memory. This quick memory data may later be recalled for monitoring or as the starting point to tune from. Refer to **section 4-3** of this manual for further information relating to VFO search.

During VFO search, quick memories may also be written to automatically when the receiver has stopped on an active channel for more than a specified period of time between 10s and 990s, this facility is default off. Refer to **section 4-4-8** of this manual for further information relating to VFO search quick memory.

4-1-2 Recalling quick memories

Once a few quick memory channels have been stored, key a different frequency into the VFO to assist identification of recalled data (until you fully understand the process).

While in 2VFO mode **PUSH**  **(F)** **PUSH**  ⇌

The LCD will display one of the quick memory channels which have been stored, use the ⇌ ⇌ keys to scroll through the list which contains up to ten frequencies. The star legend “★” is displayed toward the upper right of the LCD to indicate that quick memory recall is in operation.

 **Note:** You will note that **a maximum of 9 channels can be saved**, this is because **the VFO frequency displayed when quick memory recall is executed is automatically stored into one of the 10 locations...** this allows you to return to the previous VFO display at a later date without the data being lost and saves having to remember what the frequency / data settings were.

To revert to the VFO frequency displayed prior to the execution of quick memory recall **PUSH** 

(2VFO), the “★” legend will be removed from the LCD to confirm exit from quick memory recall.



Alternatively you may tune away from any displayed quick memory frequency using the main dial and ↑ ↓ keys, the “★” legend will be removed from the LCD to confirm exit from quick memory recall. The effect (with careful use) is similar to adding a further 10 VFOs to the AR8200 !

4-2 VFO scan

You will be aware that the AR8200 displays two VFOs with the top VFO being the ‘active’ VFO which monitors activity. At present you have to manually intervene by a **PUSH**  of the **(2VFO)** key to change between VFOs when monitoring duplex and semi-duplex channels (split frequency working when a base station transmits on one frequency and a mobile on another such as VHF marine and public service PMR... as opposed to simplex which is single frequency operation), this swaps the active VFO between “V-A” and “V-B”.

VFO SCAN causes the AR8200 to monitor the top VFO as PRIMARY and intermittently ‘flicks over’ to check for activity on the SECONDARY frequency when the primary frequency becomes inactive.

If the active frequency remains busy then the secondary remains unchecked, if however the primary becomes inactive (squench closes) then the secondary is checked every few seconds for activity. If the secondary frequency becomes active (during the time it is checked) the AR8200 will remain on the active second frequency for a few seconds, the active secondary VFO lower font size increases to indicate that the secondary VFO is being ‘actively’ monitored. The AR8200 will then return to the primary frequency to check for activity where it remains for a few seconds... so the process continues over and over.

To toggle the VFO SCAN facility on, use the VFO environment menu which is accessed with the key sequence **PUSH**  **(F)** **PRESS**  **(2VFO)**. The LCD will display “VFO MODE” with “VFO SCAN”

Receiving this frequency in LARGE font

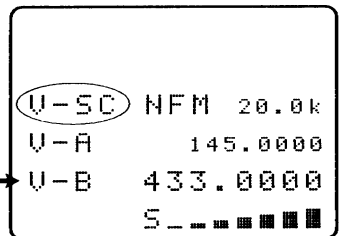

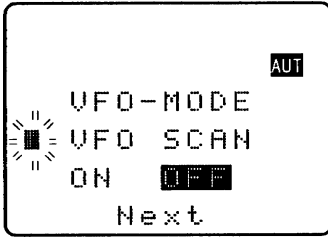

on the next line. The third line displays "ON" and "OFF" with the "OFF" legend displayed in reverse contrast to show that it is currently selected (default). To toggle the VFO SCAN on/off PUSH the (PASS) key or use the main dial or ⇐ ⇨ keys.

To accept the changes PUSH (ENT).

While VFO SCAN is active, the "2VFO" legend is replaced with the legend "V-SC" representing VFO SCAN. To toggle VFO scan off, use the same key sequence and menu.

Note: While the primary VFO remains active, VFO scan will not check the secondary VFO... VFO scan will not start! **While VFO SCAN is active, the priority facility is disabled.**

4-2-1 VFO SCAN sampling time

The time elapsed between samples and for remaining on the secondary VFO is set by PRIORITY INTERVAL time. Please refer to the **section 6-2-2** detailing priority operation. The default is time is 5 seconds.

4-3 VFO Search

It is possible to quickly assign two frequency limits to **VFO-A** and **VFO-B** then instruct the AR8200 to automatically tune the receiver from one frequency limit to the other in the specified receive mode and tuning step looking for active frequencies. This process is called **VFO SEARCH**.

4-3-1 Defining VFO search

1. Place the AR8200 into VFO mode - PUSH (2VFO).
2. Enter a frequency into **VFO-A**, i.e. PUSH (2VFO) to display "V-A" as the active 'top' VFO. Enter a frequency such as 145.200 MHz
3. PUSH (2VFO) to display "V-B" as the active 'top' VFO. Enter a different frequency such as 145.775 MHz.

Note: When the receive mode is set to AUTO, the AR8200 will take the receive mode, tuning step size and other data variables from the pre-programmed auto-mode bandplan.

4-3-2 Starting VFO search

PRESS (2VFO) to start VFO search, the legend "V-SR" indicates when VFO search is in operation.

Ensure that the squelch is closed in the absence of a signal (or VFO search will not work), the search process will start from the lowest frequency and will advance in the mode and tuning step as defined in the active 'top' VFO. Data other than frequency stored in the secondary VFO will be ignored, the data being taken from the active VFO. PUSH (2VFO) to cancel VFO search and return to 2VFO mode.

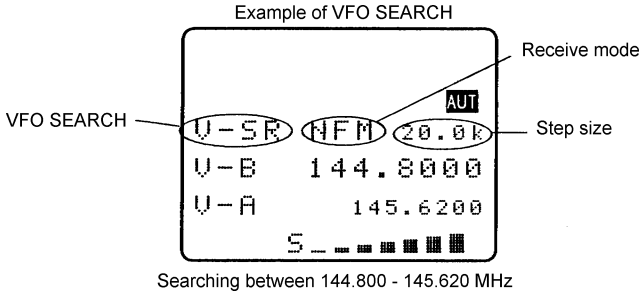

Note: While in VFO mode, if the keypad or (F) key is used, the current status of the audio with respect to the squelch control will be maintained. If the squelch is closed before you PUSH a key, the audio will remain muted until the key sequence is completed even if the frequency becomes active (and vice-versa... if the squelch is open, audio remains even when the squelch closes).

4-3-3 Forcing VFO search to resume & changing search direction

Should VFO search stop on a busy frequency, you can force the search process to resume by rotating the main dial or by pushing any of the arrow keys $\leftarrow \rightarrow \uparrow \downarrow$. The direction of rotation of main dial or arrow keys used dictates the direction of search... this is useful to back-track over an interesting frequency.

4-3-4 Locking out unwanted frequencies (PASS)

It is possible to lock out (PASS) unwanted frequencies while in VFO search mode, this is useful to eliminate unwanted permanent transmissions. It is important to understand the PASS facility before using the (PASS) key or transmissions may be missed.

While stopped on an unwanted frequency PUSH \leftarrow (PASS), the search process will resume. It will appear that **all** frequencies are still searched, however locked out frequencies will be 'passed over', the search will not **stop** on locked out frequencies but the squelch may momentarily open causing a short burst of audio before the frequency is passed... if several consecutive active frequencies are locked out, an audio 'chuff... chuff... chuff...' may be encountered.

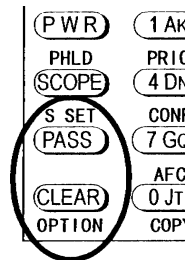

Locked out PASS frequencies are assigned PASS CHANNEL NUMBERS, there are a total of 50 PASS channels for VFO search. Frequencies ± 10 kHz from the assigned pass frequency will be skipped, carefully consider the consequences of skipping ± 10 kHz when monitoring in USB, LSB and CW.

VFO pass menu

It is possible to review, delete and add pass channels using the VFO PASS menu.

If you are currently using VFO mode or VFO SEARCH, PRESS \leftarrow (PASS), the "VFO PASS" menu will be displayed.

If PASS channels have already been tagged for VFO SEARCH the legend "PASS xx" will be displayed where "xx" indicates that data is present. If no pass frequencies have been tagged, the legend "PASS 00 ----,----" will be displayed.

The frequency pass contents may be reviewed using the ⇐ ⇨ keys or main dial.

To delete the current VFO pass frequency, key in a nul value (zero) **PUSH**  **(0 JT)** **(ENT)**.

The frequency pass channel will be deleted and the list will re-shuffle. The frequency is once again available in search mode.

To delete the entire contents of the VFO pass list **PUSH**  **(PASS)**, the legend "PASS 00 ----,----" confirms deletion. The VFO search pass list may also be deleted using the DELETE menu, refer to **section 10-2** of this manual.

Adding new pass frequencies

While in the VFO PASS menu **PUSH**  the ⇨ key to wrap around to the end of the frequency pass list, the legend "PASS xx ----,----" will be displayed where "xx" is the next available frequency pass channel. The 'dashes' indicate that the channel is currently unused. Key in a frequency which you wish to skip during VFO search using MHz format and ending with **(ENT)**.

if you wish to add further frequencies to be skipped **PUSH**  ⇨ and repeat the process. To accept the data entry and exit the menu

PUSH  **(ENT)**. This facility is particularly useful if you know what frequencies are unwanted prior to searching, such as constant carriers etc.

 **Note:** You may add frequencies in the range of 100 kHz to 2400 MHz via this menu but only those within the current search limits will be acted upon.



4-3-5 Saving active frequencies to memory

When you encounter interesting busy frequencies, you may save them to the quick memories or memory banks where they may be monitored at a later date (and scanned).

1. Quick memory

While paused on a busy frequency **PUSH**  **(ENT)**, if the keypad beep is active a confirmation tone will be audible. Quick memories may be recalled for later monitoring or to tune from in VFO mode. Please refer to **section 4-1** of this manual regarding use of the quick memories.

2. Main memory storage

While paused on a busy frequency **PRESS**  **(ENT)**, the memory input menu will be displayed with the first available blank memory channel offered. Enter the desired memory location (optionally, use the ↓ key to select additional menu items of text comment and write protect), **PUSH**  **(ENT)** to save the data.

Please refer to **section 5-2** of this manual regarding memory channel writing.

4-3-6 Exiting VFO search

To exit VFO search, PUSH (2VFO) to return to the VFO mode (the frequencies in use before VFO search was initiated will be displayed). Alternatively use the (SRCH) or (SCAN) keys to exit VFO search.

4-4 VFO environment menu

The VFO has a special menu to enable VFO scan to be toggled, VFO search to be customised, VFO auto store to be toggled on/off, memory bank "J" (which is used as the target for auto store) to be deleted and quick memory auto write to be configured.

Use the key sequence PUSH (F) PRESS (2VFO) to access the VFO environment menu. The following options are available:

1.	VFO SCAN	ON / OFF (default off)
2.	DELAY	OFF / HOLD / 0.1 - 9.9 seconds (default 2.0s)
3.	LEVEL	OFF / 1 - 255 (default OFF)
4.	VOICE	OFF / 1 - 255 (default OFF)
5.	FREE	OFF / 1 - 60 seconds (default OFF)
6.	AUTO STORE	OFF / ON (default OFF)
7.	DELETE J	Delete bank J
8.	QUICK MEMORY	OFF / 1- - 990 seconds (default OFF)





You may abort the menu at any time by pushing (CLEAR).

4-4-1 VFO SCAN

This facility is used while monitoring in 2VFO mode, the secondary VFO will be checked for activity at specified intervals. VFO scan is toggled on/off via the VFO environment menu, use the key sequence PUSH (F) PRESS (2VFO) to access the VFO environment menu. Use the (PASS) key to toggle the status on/off, the default is off. Please refer to **section 4-2** of this manual for further details of VFO scan.

4-4-2 VFO search DELAY

The VFO search DELAY parameter affects the time the AR8200 will remain on an active frequency in VFO search mode once the received signal has disappeared and the squelch has closed. This is particularly useful for customising how long the receiver will wait for a reply before resuming VFO search. For example, when communications are passed back and forth between a control tower / aircraft which may take a few seconds. The limits are OFF / HOLD and 0.1 to 9.9 seconds in 0.1s increments (default 2.0 seconds).

VFO search DELAY is configured via the VFO environment menu, use the key sequence **PUSH**  **F** **PRESS**  **(2VFO)** to access the VFO environment menu. **PUSH**  the \downarrow key once to move to the DELAY parameter. **PUSH**  **(PASS)** to toggle the status between 2.0s / HOLD / OFF, the default is 2.0s. Use the main dial to increment in 0.1s or the \leftrightarrow keys to increment in 1.0s.





- 2.0s** The AR8200 will wait the specified time after the squelch closes before resuming VFO search.
- HOLD** Once a busy frequency has been detected, the search process will be paused indefinitely.
- OFF** The AR8200 will resume VFO search instantaneously when the squelch closes.

PUSH  **(ENT)** to accept the changes and return to the display prior to accessing the VFO environment menu. Alternatively you may move to the next option (VFO search LEVEL squelch) by pressing the \downarrow key.

4-4-3 VFO search LEVEL squelch

The VFO LEVEL squelch parameter causes the AR8200 to check the signal strength and to only open the squelch when the signal strength is above the stated level (which is programmable in 256 steps). The limits are OFF and 1 to 255 (default off).

 **Note:** VFO LEVEL squelch affects *both* VFOs and VFO search.

VFO LEVEL squelch is configured via the VFO environment menu, use the key sequence **PUSH**  **F** **PRESS**  **(2VFO)** to access the VFO environment menu. **PUSH**  the \downarrow key twice to move to the LEVEL parameter. **PUSH**  **(PASS)** as a short cut to off (which is the default). Use the main dial to increment value in by 1 or use the \leftrightarrow keys to increment by 10.

While adjusting level squelch, the “★” legend will be displayed to the left of the value “**LEVEL ★ 3**” indicating that the current value will *not* cause the squelch to close. Increase the value until the “★” legend is just extinguished (this may typically be around a value of 120 - 230), the current transmission and signals below this level *will* be skipped. There will be no audio produced when a transmission is encountered below the level configured even though the “S” squelch legend is displayed. This is a useful alternative to regular squelch on noisy bands such as short wave.

The approximate relationship between signal meter segments and 'level value' is as follows:

1	2	3	4	5	6	7	8	9	10	11	12	13	14
124	141	154	168	178	185	193	200	203	206	208	210	212	214

 **Note:** When level squelch is in operation, the rotary squelch control is usually best rotated to the fully anti-clockwise position.





PUSH  (ENT) to accept the changes and return to the display prior to accessing the VFO environment menu. Alternatively you may move to the next option (VFO VOICE squelch) by pressing the ↓ key.

While in VFO or VFO search, the LCD legend “**LSQ**” is displayed to indicate that VFO level squelch is in operation.

4-4-4 VFO search VOICE squelch

The VFO VOICE squelch parameter causes the AR8200 to check the current frequency for valid audio and to only open the squelch when audio above a specified level (which is programmable in 256 steps) is detected. The limits are OFF and 1 to 255 (default off).

 **Note:** VFO VOICE squelch affects *both* VFOs and VFO search.

VFO VOICE squelch is configured via the VFO environment menu, use the key sequence PUSH  (F) PRESS  (2VFO) to access the VFO environment menu. PUSH  the ↓ key three times to move to the VOICE parameter. PUSH  (PASS) as a short cut to off (which is the default). Use the main dial to increment value in by 1 or use the ⇐ ⇒ keys to increment by 10.





While adjusting voice squelch, the “★” legend will be displayed to the left of the value “**VOICE ★ 12**” indicating that the current value will *not* cause the squelch to close. Increase the value until the “★” legend is just extinguished (this may typically be typically around a value of 1 to 100), the current transmission and signals with audio below this level *will* be skipped. There will be no audio produced when a transmission is encountered with audio below the level configured even though the “**S**” squelch legend is displayed.

 **Note:** When voice squelch is in operation, the rotary squelch control is usually best rotated to the fully anti-clockwise position.

PUSH  (ENT) to accept the changes and return to the display prior to accessing the VFO environment menu. Alternatively you may move to the next option (VFO FREE search) by pressing the ↓ key. While in VFO or VFO search, the LCD legend “**VSQ**” is displayed to indicate that VFO voice squelch is in operation.

4-4-5 VFO FREE search

The VFO FREE search parameter determines how long the AR8200 will remain on an **active** frequency before resuming VFO search even though the frequency is still active. This is useful if you wish to gain a picture of what is happening on a band without the AR8200 being tied to a busy frequency for long periods of time (such as when monitoring active amateur band repeaters etc). VFO FREE search saves you having to manually intervene to force the VFO search process to resume and saves the need to lockout frequencies using the FREQUENCY PASS facility. The limits are OFF and 01 to 60 seconds (default is off).





VFO FREE search is configured via the VFO environment menu, use the key sequence **PUSH**  **(F)** **PRESS**  **(2VFO)** to access the VFO environment menu. **PUSH**  the \downarrow key four times to move to the FREE parameter. **PUSH**  **(PASS)** to toggle between OFF and 5 seconds (the default is off). Use the main dial to increment value by 1s or use the $\leftarrow \rightarrow$ keys to increment by 5s. **PUSH**  **(ENT)** to accept the changes and return to the display prior to accessing the VFO environment menu. Alternatively you may move to the next option (VFO AUTO STORE) by pressing the \downarrow key.

While in VFO search, the LCD legend “**FRE**” is displayed to indicate that VFO free search is in operation and the search process will only pause on active frequencies for the specified time.

4-4-6 VFO AUTO STORE

The VFO auto store causes the first 50 active frequencies located during VFO search to be automatically written into memory bank “**J**” (channels J00 to J49). If bank “**J**” is full, VFO auto store will not function.

 **Note:** Memory banks are dynamically configurable so that bank “**J**” has 50 channels at default but can be configured to provide 10, 20, 30, 40, 50, 60, 70, 80, or 90 channels. Refer to **section 5-7** of this manual regarding dynamic memory bank resizing.



VFO auto store is configured via the VFO environment menu, use the key sequence **PUSH**  **(F)** **PRESS**  **(2VFO)** to access the VFO environment menu. **PUSH**  the \downarrow key five times to move to the AUTO STORE parameter. **PUSH**  **(PASS)** or use the $\leftarrow \rightarrow$ keys to toggle VFO auto store on/off (default is off).

PUSH  **(ENT)** to accept the changes and return to the display prior to accessing the VFO environment menu. Alternatively you may move to the next option (DELETE J) by pressing the \downarrow key (which is useful before exiting the environment menu).



While in VFO search, the LCD legend “**AS**” is displayed to indicate that VFO auto store is in operation. Frequencies closer than ± 10 kHz to a frequency already stored in bank “**J**” will be ignored, this prevents the same frequency being stored over and over again.

4-4-7 DELETE bank “J”

To simplify the results of VFO auto store, it is possible to delete the contents of memory bank “**J**” using this menu... this allows you to quickly ‘dump’ the unwanted contents of the auto store memory bank “**J**” before starting a new VFO search with the auto store feature enabled.







DELETE BANK “J” may be executed via the VFO environment menu, this is best carried out immediately after the auto store facility has been activated. Alternatively you can ‘dump’ the contents of the auto store bank “**J**” at any time. Use the key sequence **PUSH**  **(F)** **PRESS**  **(2VFO)** to access the VFO environment menu. **PUSH**  the \downarrow key six times to move to the “**DELETE J**” parameter.



If bank "J" contains data, the legend "J00" will be displayed (the number indicating the presence of data), if no data is held in bank "J" the legend "J--" will be displayed. PUSH  (PASS) to delete the contents of bank "J", this will take a few seconds to action by the CPU. The legend "J--" will be displayed to confirm deletion.

PUSH  (ENT) to return to the display prior to accessing the VFO environment menu. Alternatively you may move to the next option (QUICK MEMORY) by pressing the  key.

4-4-8 VFO QUICK MEMORY

It is possible to automatically save the current VFO frequency or frequencies found during VFO search (as an alternative to VFO search auto store) to the 10 quick memories for rapid recall. To automatically distinguish between 'interesting' and 'uninteresting' frequencies, you may set the length of time you need to monitor the frequency before the automatic save takes place. The available range is OFF / 10s - 990s in 10 second increments (default is off).

VFO quick memory is configured via the VFO environment menu, use the key sequence PUSH  (F) PRESS  (2VFO) to access the VFO environment menu. PUSH  the  key seven times to move to the QUICK MEMORY parameter. PUSH  (PASS) to toggle between off and 60s or use the main dial to increment in 10s and the   keys to increment in 100s.

PUSH  (ENT) to accept the changes and return to the display prior to accessing the VFO environment menu. Alternatively you may move to the top of the VFO environment option list by pressing the  key.

While in VFO or VFO search mode, frequencies monitored for longer than the specified quick memory period will be automatically saved to the 10 quick memories. To prevent duplication, frequencies closer than ± 10 kHz to a frequency already held in quick memory will be ignored. While in VFO mode, you may still manually write to quick memories by pushing (ENT). Once all 10 quick memories have been used, the oldest will be overwritten in sequence.

To recall quick memories while in VFO mode, PUSH  (F) PRESS   , to cycle through the quick memories use the   keys.

For further information regarding quick memories, refer to **section 4-1** of this manual.

(5) Memory channels & banks

It is convenient to store commonly used frequencies into a memory channel along with mode etc, this saves having to key the data in over and over again. Memory read is very straightforward and quick when compared to re-typing all data.

5-1 Memory channel overview

Think of memory channels as pages in a notebook each of which is numbered to identify it. Data may be written to each new page (memory channel) and each page may be overwritten with new data, they can be used over and over again. The AR8200 has **1,000 memory channels** in addition to **10 'quick memory' channels** and a **priority channel**.

Each memory channel may hold:

- *one frequency*
- *receive mode*
- *tuning step*
- *step-adjust*
- *frequency offset*
- *attenuator setting*
- *noise limiter status*
- *AFC status*
- *pass status*
- *write protect*
- *text comment of up to 12 characters*

The alphanumeric comment may be used to ease identification at a later date and to provide text search facilities.

The 1,000 memory channels are divided into 20 banks, each initially having 50 channels. The memory banks are identified by letters A, B, C, D, E, F, G, H, I, J (upper case letters) and a, b, c, d, e, f, g, h, i, j (lower case letters) and initially numbered from 00 to 49.

Examples are "A00" for the first channel location in memory bank "A" and "A49" for the last memory channel in memory bank "A". "e15" is the location of memory bank "e" (lower case) channel "15".

During the manufacture and testing of the receiver, various test frequencies may be entered into the receiver's memory banks so the memory locations may not be completely blank.

 **Note:** Where memory channels and banks are empty the indication "- -" is often displayed.

The stored data may be quickly and easily recalled, changed or deleted using the memory recall, edit and delete facilities.

 **Note:** *It is suggested that one or two frequencies be held in each memory bank to make the recalling and scrolling of memory banks fluent, if no data is stored, the AR8200 may take up to 5 or 6 seconds to respond when attempting to change memory bank while the CPU checks for data.*

Auto-store

When shipped from the factory, memory bank "J" is reserved for auto-store of memory channels from search mode. This is a useful facility to quickly build a list of active frequencies. Please refer to **section 8-7-5** of this manual for further information regarding AUTO-STORE.

Dynamic memory bank resizing

The lettered memory banks are regarded as a 'pair' making a total of 100 memory channels per bank, initially equally divided between the upper and lower case letters. It is however possible to reallocate the 100 channels in blocks of 10 channels between the same letters A/a, B/b, C,c etc. This means that the initial 50/50 may be reallocated as 60/40, 70/30, 80/20, 90/10, or 10/90, 20/80, 30/70, 40/60. This 'dynamic' memory reallocation can be useful to optimise the memory layout where a large or small collection of frequencies need to be monitored without unnecessarily wasting memory banks with just a few channels occupied.

Write protect

It is possible to write protect individual memory channels to prevent accidental deletion, whole memory banks and a 'global' write protect facility are also available.

Memory backup

The data contents of memory and search banks are held in an flash-ROM so that no backup battery or capacitor is required for memory retention.

 **Note:** When the AR8200 is switched OFF, all VFO data will be automatically stored. Should the NiCads (or dry batteries if in use) become completely exhausted, the last stored memory channel or last VFO data 'may' be lost if the AR8200 is not powered-down using the **(PWR)** key and insufficient power is available to save the data.

5-2 Storing VFO frequencies & data into memory



It is possible to save frequencies to the ten quick memories for simple recalling but for longer-term storage, the 1,000 main memory channels offer a better and more flexible system.

The process to save a displayed VFO frequency to memory is as follows:

- a) In VFO mode, select the required frequency, mode, attenuator etc
- b) PRESS  **(ENT)** to initiate memory write
- c) Use the keypad, main dial or \leftrightarrow \updownarrow keys to select the desired memory location (BANK and CHANNEL)
- d) Add a text comment (optional) or delete an existing comment
- e) Add memory channel write protect (optional)
- f) Exit the menu to save the data to the specified memory location

Lets assume that you wish to store the frequency of 123.500 MHz (with the attenuator off, noise limiter off, AFC off) into memory bank "E" location "25" (E25) while in VFO mode with the text comment of "AIRBAND". If a mistake is made during programming, PUSH  the

(CLEAR) key to abort entry and return to 2VFO mode.

- a) Start by selecting VFO mode then key in the frequency of 123.500 MHz, "mode and step size" are set to the default auto "AUT" (if not use the key sequence PUSH  **(F)** PRESS  **(3 CM)**)

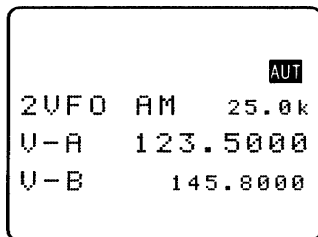

PUSH (2VFO) to place the AR8200 into VFO mode.

PUSH (1 AK) PUSH (2 BL) PUSH (3 CM) PUSH (● Aa) PUSH (5 EO)

PUSH (ENT) to select the desired frequency, the mode and step size will be automatically set by the AR8200 microprocessor.

b) PRESS the (ENT) key for more than one second to enter 'memory input' mode.

One line up from the bottom of the LCD will be the legend "M-WRITE" with the highlight cursor positioned to the left of the bank identification letter such as "J". The microprocessor will automatically select the **youngest** free memory location.

c) You may change the bank identifier at this time by pushing the ⇄ ⇄ keys or by typing in a three digit memory location using the numeric keypad.

You will notice that to the right of the keypad numbers, there are small orange letters which are bank identifiers, available memory locations are A - J and a - j. Key 1 is "A", key 2 is "B" etc, ignore the letters K - T as these are used in search mode only. The lower case bank identifiers may be accessed pushing the CASE SHIFT

key (● Aa)

Remember, if you take too long entering data (90 seconds) the display will revert to it's original condition of 2VFO mode, if you are selecting the memory location via a three digit key sequence, you only have 2 seconds before the keypad times-out!

Assuming that you wish to store 123.500 MHz into "E25" PUSH

(5 EO) to select bank "E" then select the channel, PUSH

(2 BL) PUSH (5 EO) for "25". If any data is already stored in location "E25", the bottom line of the LCD will flash with the stored frequency. You may accept & store the data (by pushing

(ENT) or add a text comment at this point (see below).

d) To add the text comment "AIRBAND", PUSH ↓ then use the main dial to select the text and the ⇄ ⇄ keys to move position of text input.

A maximum of 12 characters may be added to each memory channel, it is recommended that a minimum of three be used for efficient use of the text search feature (a minimum of 2 characters are required for text search). Refer to **section 12** of this manual for details of text search and **section 13-2** for short cut text input).

AUT
2VFO AM 25.0k
U-A 123.5000
U-B 145.8000

AUT
2VFO AM 25.0k
U-A 123.5000
M-WRITE J49
BANK

AUT
2VFO AM 25.0k
U-A 123.5000
M-WRITE E25
---.---

AUT
2VFO AM 25.0k
U-A 123.5000
M-TEXT E25
I7-BAND

If the memory location has been used previously and a text comment is displayed, PUSH (PASS) to delete the existing comment.

Note: It is possible to use keypad short cuts to select text characters, please refer to **section 13-2** of this manual for further details.

You may accept the new frequency and text comment “AIRBAND” by pushing (ENT) or you may add memory channel write protect (see below).

e) To add the memory channel write protect, PUSH ↓ to access the “PROTECT” menu, the default is off. PUSH (PASS) to toggle the status to “ON”.

To accept the input and store the data to the specified location, PUSH (ENT). The display will revert to 2VFO mode.

Important note: It is suggested that you do not use the write protect facility until you are familiar with the operation of the AR8200 as it will prevent certain functions being carried out at a future time.

5-2-1 Another example of memory write

Let’s assume that you wish to store the frequency of 433.000 MHz auto-mode into memory location “d10” with the text comment of “70cm”.

a) PUSH (2VFO) to place the AR8200 into VFO mode

PUSH (4 DN) PUSH (3 CM) PUSH (3 CM) PUSH (ENT) to select the desired frequency.

b) PRESS (ENT) to initiate ‘memory input’ mode.

c) Select the bank by pushing the ⇐ ⇨ keys and using the main dial for channel number, or by typing in a three character memory address using the numeric keypad.

Assuming that you wish to store 433.000 MHz into “d10” PUSH (● Aa) which acts as the CASE SHIFT key to select the lower case banks then PUSH (4 DN) to select bank lower case “d”. Next select the channel PUSH (1 AK) PUSH (0 JT) for “10”. If any data is already stored in location “d10”, the bottom line of the LCD will flash with the stored frequency.

You need to carry out this key sequence fluently within 2 seconds or the bank location will time out. The 2 second time out does not apply when the bank and channel are selected using the main dial and ⇐ ⇨ keys.

To recap:

PUSH (● Aa) PUSH (4 DN) PUSH (1 AK) PUSH (0 JT)

Once the three digit memory location has been selected, the 2 second keypad time-out does not apply to the rest of the sequence.

d) To add the text comment "70cm", PUSH ↓ then use the main dial to select the text and the ⇐ ⇒ keys to move position of text input. To accept the new frequency and text comment "70cm", PUSH (ENT), if you wish to add write protect PUSH ↓ to access the **PROTECT** menu.

Note: If the memory location has been previously used and a text comment is displayed, PUSH (PASS) to delete the existing comment.

e) In the write protect menu, PUSH (PASS) to toggle the status to "ON", the default is off.

To accept the input and store the data to the specified location, PUSH (ENT). The display will revert to 2VFO mode.

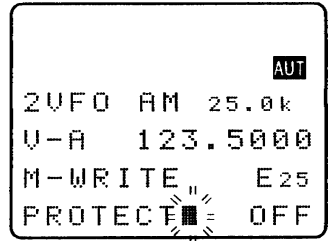

5-2-2 Automatic memory allocation

When you PRESS (ENT) to start the memory write sequence, the AR8200 will initially offer the first available empty memory location which has no data stored in it. PUSH (ENT) to accept the channel offered or choose another location as described in the previous sections. Alternatively you may PUSH the ↓ key to add a text comment then complete memory write by pushing (ENT). If the AR8200 has to look through many full memory channels before an empty channel is located, the message "MEM WRITE SEARCH BLANK CH" may be briefly displayed.

5-3 Memory write protect

As indicated in **section 5-2**, it is possible to write protect memory contents to ensure that important memory channels are not accidentally over-written. It is important to remember that by write protecting a memory channel, it may prevent certain facilities from being used (such as over-writing the memory channel or copying / swapping memory data to it).

The memory protect status may be assigned as the last stage of memory write (as per **section 5-2** of this manual) or toggled on/off using the memory channel EDIT facility, refer to **section 9-6** of this manual regarding memory channel EDIT facilities, in particular MEMORY PROTECT.

It is also possible to write protect a whole memory bank, this prevents accidental deletion of data when resizing memory banks.

The memory bank write protect may be toggled on/off using the SCAN environment menu accessed by the key sequence **PUSH** (F) **PRESS** (SCAN) followed by four pushes of the \downarrow key. **PUSH** (PASS) to toggle bank select on/off and **PUSH** (ENT) to accept the changes and exit the menu. Please refer to **section 7-8-6** of this manual for details on MEMORY BANK write PROTECT.

 **Note:** Memory channel write protect prevents accidental over-writing and deletion of specific memory channels but does not prevent loss of data due to memory resizing or when using the optional external memory slot card.

5-4 Memory read “M.RD”

Once frequency and mode data has been stored into a memory location, its retrieval is quick and simple.

Let's assume that you wish to retrieve the frequency of 123.500 MHz which has been programmed into to memory “E25” during an earlier example in the preceding **section 5-2** of this manual.

PUSH (SCAN) to place the receiver into **memory read mode**, the legend “M.RD” appears toward the top left of the LCD to confirm operation. The AR8200 will monitor whatever memory channel first appears when you enter memory read.

The AR8200 will display memory channel, mode, frequency, tuning step, text comment (if one was used), attenuator status, noise limiter status and AFC status. The memory channel last used (for memory write or recall) will initially be displayed, If the desired memory channel is not immediately displayed it may be recalled by keying in the required three digit location.

To recall memory channel “E25” **PUSH** (5 EO) **PUSH** (2 BL) **PUSH** (5 EO)
 (there is no need to push enter).

Example of memory read

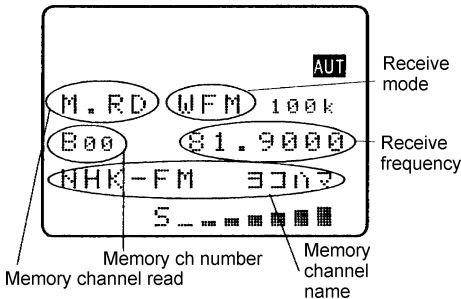

The “**BANK/CH SEL**” legend automatically appears when the first key is pushed to remind you that you are recalling memory channels in memory read mode. Keypad memory recall requires a three digit location, one letter for the bank and two numbers for the channel. If you hesitate for more that 2 seconds while recalling memory channels via the keypad the sequence will time out, for more leisurely memory recall use the \leftrightarrow \uparrow \downarrow keys.

To recall memory “b06” the CASE SHIFT key needs to be used to access the lower case bank, **PUSH** (Aa) **PUSH** (2 BL) **PUSH** (0 JT) **PUSH** (6 FP) (there is no need to push enter). If you attempt to recall a memory which has no valid data (because it is blank) the next valid memory channel will be displayed instead. Blank memory channels are ignored.

5-4-1 Memory channel review / hunt

From VFO mode PUSH  (SCAN) to enter memory read "M.RD" mode.

The **main dial** may be rotated or the \uparrow \downarrow keys pushed to review, hunt for and select memory **channels** one by one, channels with no data stored will be skipped. PUSH  the \leftarrow \rightarrow keys to move between memory **banks** one by one.

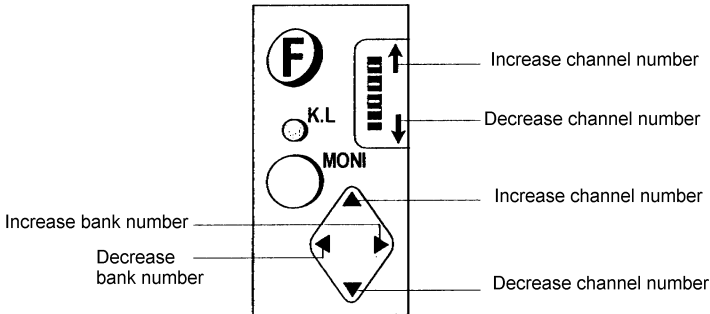



 **Important note:** It is suggested that each memory bank be programmed with at least one memory channel otherwise the AR8200 may appear **slow or sluggish** when recalling banks as the CPU has to check all memory channels for valid data, this is particularly noticeable if jumping between bank "A" and "J" (opposite ends of the AR8200 memory map).

Memory read using the main dial and \leftarrow \rightarrow \uparrow \downarrow keys is useful for reviewing memory contents and hunting for a specific channel if you forget where you stored it! Should you know the number of the required memory channel, the keypad method of memory recall will be much faster. The AR8200 will monitor whichever memory channel is displayed in memory read "M.RD" mode.

It is also possible to hunt for memory channels using the TEXT SEARCH facility, please refer to section 12-2 of this manual for further details.

5-5 Deleting memory channels

It is possible to over-write a memory channel with new data, edit the contents of a memory channel or delete the channel entirely. When in memory read mode, use the key sequence PUSH  (F)

PUSH  (9 IS) to access the "MEM DELETE" menu. The LCD menu invites you to "PUSH ENTER"

to delete the current memory channel, PUSH  (ENT) to delete it or PUSH  (CLEAR) to abort.

When deleted, the AR8200 increments to the next memory channel which contains data. It is also possible to delete whole memory banks in one go using the DELETE menu. Please refer to the **section 10-3** of this manual relating to memory bank DELETE options.

5-5-1 Memory channel editing

It is possible to copy, move, swap and edit memory channels to assist the management of data. Please refer to **section 9** of this manual regarding the EDIT menu.

5-5-2 Adding text names to memory banks

To assist with memory management and identification, memory banks can be named. The SCAN BANK menu is used to add or edit memory bank names.

To access the SCAN BANK menu PUSH  (F) PRESS  (SCAN). The LCD will initially display the legend "M-BANK", the currently selected memory bank 'pair' (i.e. D/d or A/a or C/c etc) and the current size allocation for the bank displayed i.e. B:50 b:50 for memory bank "B/b" with the allocation of 50 channels for "B" and 50 channels for "b", this split of 50/50 being the default.

Use the main dial, ⇄ keys or numeric keypad to select the required bank you wish to add a name to. PUSH  the ↓ key to move to the "BANK TEXT" menu.

Use the ↑ ↓ keys to move between upper and lower bank identifiers, add text using the main dial and ⇄ ⇄ keys or use the keypad. To save the data and exit the menu PUSH  (ENT).

5-6 Transfer of memory channel to VFO

While in memory read, should you wish to tune away from the memory channel and benefit from not having to re-enter the frequency, mode etc, the data may be quickly transferred from memory to 'VFO' mode.

To transfer memory channel data to VFO simply PUSH  (ENT). The LCD will display the legend "VFO" along with receive frequency, receive mode, tuning step size and other relevant information such as attenuator, noise limiter and AFC status. You may monitor the frequency or tune away from it using the main dial or ⇄ ⇄ ↑ ↓ keys.

5-7 Dynamic memory bank resizing

The lettered memory banks are regarded as a 'pair' making a total of 100 memory channels per bank, initially equally divided between the upper and lower case letters. For example memory bank "A" will have 50 channels numbered from 00 to 49 (A00 - A49) and memory bank "a" will also have 50 channels numbered from 00 to 49 (a00 - a49) making a total of 100 channels.

It is possible to reallocate the 100 channels in blocks of 10 channels between the same letters A/a, B/b, C,c etc This means that the initial 50/50 may be reallocated as 60/40, 70/30, 80/20, 90/10, or 10/90, 20/80, 30/70, 40/60. This 'dynamic' memory reallocation can be useful to optimise the memory layout where a large or small collection of frequencies need to be monitored without unnecessarily wasting memory banks with just a few channels occupied.

The SCAN BANK menu is used to customise many features including memory bank resizing.

To access the SCAN BANK menu PUSH  (F) PRESS  (SCAN).

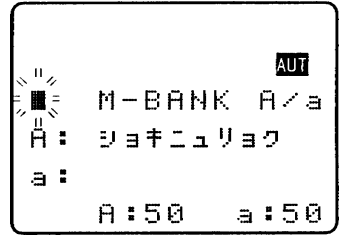

The LCD will initially display the legend "M-BANK", the currently selected memory bank 'pair' (i.e. **D/d** or **A/a** or **C/c** etc) and the current size allocation for the bank displayed i.e. **A:50 a:50** for memory bank "A/a" with the allocation of 50 channels for "A" and 50 channels for "a", this split of 50/50 being the default. Use the main dial, \leftarrow \rightarrow keys or numeric keypad to select the required

bank for resizing. PUSH  the \downarrow key to move to the "BANK TEXT" menu where a text comment may be added (optionally) to ease identification of each bank (use the \uparrow \downarrow keys to move between upper and lower bank identifiers).



PUSH  the \downarrow key to move on to the resizing menu. The LCD will display the upper and lower case identifiers on the same line with the current default allocation of 50/50 channels per bank. Use the main dial or \leftarrow \rightarrow keys to reallocate the channels in increments of 10 channels (60/40, 70/30, 80/20, 90/10, or 10/90, 20/80, 30/70, 40/60).

 **Note:** If you resize a memory which currently contains 50 channels to a new size of 10 channels, the last 40 channels will be deleted and data will be lost! Potentially when you resize memory banks, programmed data may be lost so it is suggested that you *carefully organise your memory data before resizing memory channels*. Individual memory channel protect will be ignored but if a whole memory bank is protected, resizing will be inhibited.

After selecting the resizing value PUSH  \downarrow to display the memory sorting menu, the legend "MEM SORTING" will be displayed, the following lines confirm the current and *proposed* memory bank sizes. PUSH  (PASS) to initiate the resizing process. The LCD will clear except for the words "MEM SORTING !!" with the exclamation marks flashing to indicate that the sorting process is in operation... *this can take several minutes* depending upon the amount of data held in memory. After sorting, the display returns to its previous condition (before the SCAN BANK menu was accessed).

 **Important note:** Memory sorting can take several minutes, do not switch the AR8200 off, disconnect power, remove batteries or allow the batteries to fail during memory sorting or data corruption may occur.

(6) Priority operation

The PRIORITY feature enables you to carry on scanning, searching or monitoring while the AR8200 checks a frequency taken from one of the 1,000 memory channels (**A00** default) every 5 seconds (default) for activity.

The priority checking is accomplished by momentarily moving to the priority frequency to see if it is 'active'. If activity is found, the receiver remains on the frequency until the signal disappears. If no activity is detected, the receiver returns to the VFO frequency, scan channel or search bank from where it originated. The priority facility has a large number of applications and is particularly useful for keeping an eye on a distress frequency while scanning or searching another frequency band.

 **Note:** Depending upon the frequency and mode stored as priority, an audible 'click' may be heard when the priority facility is in operation. This is quite normal and is caused by the internal switching of circuitry necessary to accomplish the frequency change as two frequencies cannot simultaneously be monitored by the receiver.

Note: The priority mode is automatically suspended during entry of frequencies via the keypad, this prevents the receiver from changing frequency while you are busy programming. Priority operation is disabled when the band scope is in operation.

6-1 Engaging PRIORITY channel

Once engaged, the default channel used for PRIORITY is "A00" and the frequency contained is checked for activity every 5 seconds.

First ensure that there is data stored in memory channel "A00".

To engage the priority facility **PUSH** **F** **PUSH** **4 DN**, this may be carried out while in SCAN, SEARCH or VFO modes. The legend "PRI" is displayed in the top left hand corner of the LCD to indicate that PRIORITY IS ENGAGED (switched on).

If activity is encountered on the priority channel, the AR8200 will stay on the priority frequency until the transmission ends (and the squelch closes) after which time the priority frequency will be checked for activity every few seconds.

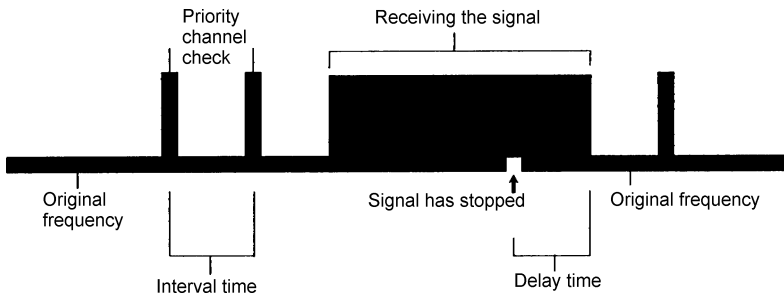

Note: Once priority has been activated, the data contents of the memory channel used (default A00) may be altered without affecting the data used for PRIORITY operation which is stored separately and assumes an identity of its own irrespective of the data contents of memory A00.

Should you subsequently wish to alter the priority data, you will have to use the "PRIO SET" menu detailed in section 6-2-1 of this manual.

To cancel priority operation **PUSH** **F** **PUSH** **4 DN** (which acts as a toggle), the legend "PRI" will be removed from the LCD.

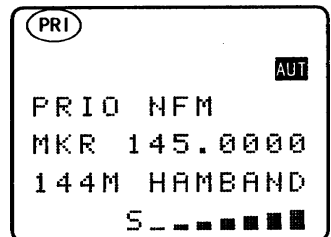

6-2 Changing PRIORITY channel data



The default channel used for PRIORITY is "A00" and the frequency copied from this channel is checked for activity every 5 seconds. You may select a different memory channel from which the data will be copied or may vary the sampling time for priority activity checking.

This is accomplished by using the "PRIO SET" menu accessed by the key sequence **PUSH**  **(F)** **PRESS**  **(4 DN)**.

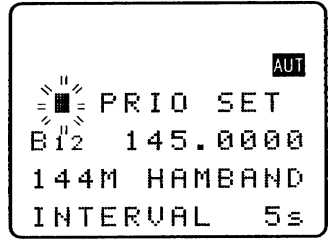

The legend "PRIO SET" appears on the top line of the LCD to confirm selection.





6-2-1 Changing the priority channel data pickup channel

Should you wish the priority channel to use data contained in another memory location, access the "PRIO SET" menu using the key sequence **PUSH**  **(F)** **PRESS**  **(4 DN)**, the legend "PRIO SET" appears on the top line of the LCD to confirm selection.



Select the new location for data pickup by the priority channel, use the main dial to move through the memory locations one at a time or use the $\leftarrow \rightarrow$ keys to move between banks, alternatively quickly key in a three digit memory location via the keypad.

For example, select memory location "A23" using the key sequence **PUSH**  **(1 AK)**
PUSH  **(2 BL)** **PUSH**  **(3 CM)**.

The priority interval time menu may be accessed using the \downarrow key or **PUSH**  **(ENT)** to exit the menu. The newly nominated channel data will be used for priority monitoring.

 **Note:** If you attempt to nominate a channel which contains no data, the input will be ignored and the previously used data will continue to be employed.

6-2-2 Changing priority interval time

Should you wish to check the priority frequency more or less often, the sampling time (interval) may be set using the "PRIO SET" menu. Use the key sequence **PUSH**  **(F)** **PRESS**  **(4 DN)** to access the "PRIO SET" menu. **PUSH**  the \downarrow key to move the cursor to the "INTERVAL" input line.

Use the main dial to vary the interval time in increments of 1 second, the $\leftarrow \rightarrow$ keys may be used to vary the interval time in increment of 10 seconds. Priority time may be varied between the range of 1s to 99s. **PUSH**  the **(PASS)** key to act as a short cut to 5 seconds (default).

The more often you check the priority channel, the greater chance you have of 'catching' activity, however the greater the interruption to normal monitoring.

PUSH  **(ENT)** to accept the input and exit the menu.

 **Note:** Priority interval time is also used for VFO SCAN timings.

(7) SCAN - scanning memory channels & banks

The AR8200 has a **SCAN** mode whereby the contents stored in the **MEMORY CHANNELS ARE AUTOMATICALLY RECALLED AND MONITORED** very quickly for activity - scanned.

* It is important that you do not confuse SCAN and SEARCH modes. *
SEARCH mode (covered later in this manual) automatically **TUNES THE RECEIVER THROUGH ALL FREQUENCIES** between two specified frequency limits looking for active frequencies.

7-1 SCAN - outline introduction

During SCAN, the AR8200 automatically recalls each memory channel which contains data in numeric order and monitors it looking for activity. When an 'active' memory channel is located (when a signal is found and the squelch is open) the AR8200 will temporarily stop scanning.

At default when shipped from the factory, the AR8200 will remain on the active memory channel until the received signal disappears and the squelch closes. The CPU will then wait a further 2 seconds in case a reply is audible (such as aircraft and air traffic communications) and will then resume scanning the memory channels again.

If the \uparrow \downarrow keys are pushed or the main dial rotated (while scanning or when stopped on an active channel), the receiver resumes scanning in the direction of the arrow key or rotation. This is particularly useful for taking a second look at channels which have just been scanned.

Additional facilities available in SCAN

Memory banks may be "**LINKED**" and "**UNLINKED**" to effectively make larger or smaller groups of memories which may be scanned together.

"**PASS**" may be used whereby memory channels can be skipped when not required (such as when permanently busy), they may be easily reinstated at a later time.

"**AUTO STORE**" reserves memory bank "**J**" so that active frequencies found while conducting a **SEARCH** may be automatically written to memory. This is a useful tool for compiling an activity list of rarely used frequencies especially when unattended. Refer to **section 8-7-5** of this manual for further information relating to auto store.

It is possible to alter the sequence of scanning events using the **SCAN ENVIRONMENT** menu. There are several scanning parameters which may be changed to suit your preferences and requirements **DELAY, LEVEL, VOICE, FREE & MODE**, it is possible to mix combinations of all parameters.

7-2 SCAN considerations

It is presumed that you have already stored your favourite and commonly used frequencies into the memory banks (as per **section 5-2** of this manual).

A total of 1,000 memory channels are provided which are divided into 20 banks, each (at default) having 50 channels. The memory banks are identified by letters A, B, C, D, E, F, G, H, I, J (upper case letters) and a, b, c, d, e, f, g, h, i, j (lower case letters) and numbered from 00 to 49.

When in SCAN MODE, the memory banks are referred to as "SCAN BANK A", "SCAN BANK B", "SCAN BANK f" etc rather than using the full title "SCAN MEMORY BANK A", "SCAN MEMORY BANK B" etc. This terminology has been employed to make the explanation of and referral to SCAN MEMORY BANKS (SCAN BANKS) less long-winded.

When shipped from the factory, memory bank "J" is reserved for auto-store of memory channels from search mode so may already have frequencies stored.

Keep your memory banks tidy - for best scan speed

In order to achieve the maximum scanning speed, it is advisable to keep all similar frequencies and modes grouped together within the memory banks. The greater the frequency change between memory channels, then the further the receiver's VCO (Voltage Controlled Oscillator) has to travel and the slower the scan rates. Similarly, when many changes of mode are called, more switching has to be accomplished and the scan speed may be reduced.

Memory channel data may be entered in duplicate into several channels. This will ensure the channel data is scanned more frequently to increase the chances of activity being detected.

Limitations of SCAN mode

Should a number of different modes and wide range of frequencies be used, then the SCAN process may be affected by noise or differences in squelch characteristic on some frequencies and modes.

To help provide the best operation of SCAN, additional facilities have been provided (configurable via the SCAN ENVIRONMENT menu). Should you listen to noisy frequencies or bands containing carriers, make liberal use of the AUDIO, LEVEL and FREE scan facilities.

7-3 Starting to SCAN



Presuming that some memory channels are programmed with data, to start the scan process will take one or two pushes of the (SCAN) key depending upon which operating mode is currently employed (in VFO and search mode the first press accessed memory read):-

- Memory read mode "M.RD" PUSH (SCAN)
- VFO mode "VFO" or "2VFO" PUSH (SCAN) PUSH (SCAN)
- Search mode "SRCH" PUSH (SCAN) PUSH (SCAN)

The legend "SCAN" is displayed toward the top left of the LCD to indicate that the SCAN process has been started, a bank letter will also be displayed representing the current bank. **Ensure that the squelch control is advanced clockwise to threshold point so that background noise is cancelled and the squelch closes (otherwise scan will not operate).**

Example of SCAN

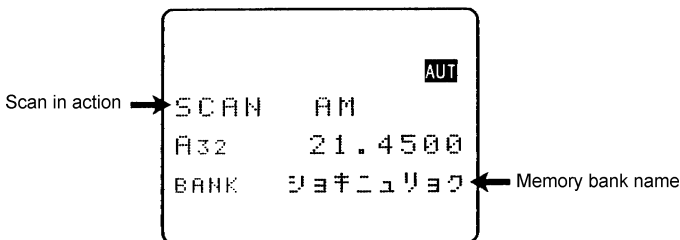

When SCAN has been selected, only the currently displayed memory bank WHICH CONTAINS DATA will be SCANNED (as bank link is default off), receive mode and frequency are unimportant. Any memory channels which contain no data (empty) will be ignored (skipped).

7-3-1 Transfer of active memory to VFO

When the scan process is paused on a busy channel, PUSH **ENT** to transfer the current memory frequency to VFO where it may be monitored.

7-4 Selecting a scan bank

The memory bank identifier (such as "A") will be displayed on the left of the LCD under the legend "SCAN". If more than one memory channel is programmed into the current memory bank the channel numbers will be changing.

When an 'active' channel has been located (busy, so the squelch opens) the scan process will temporarily pause on the active channel, the memory location (such as "A03") will be displayed along with any accompanying text (displayed underneath the memory location).

To select another memory bank for scanning, use the $\leftarrow \rightarrow$ keys or

PUSH the corresponding letter on the keypad from A to J, for lower case banks

PUSH the **• Aa** CASE SHIFT key first.

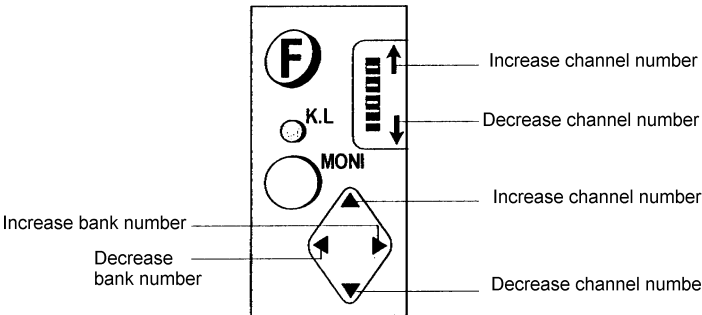
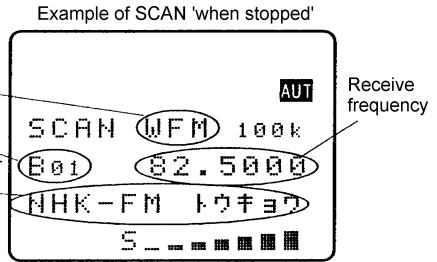
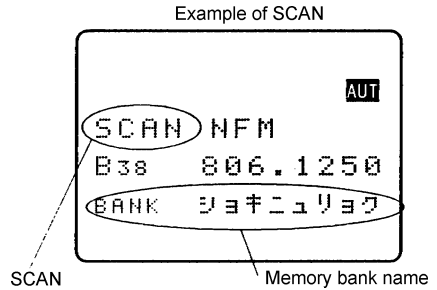

If no data is available, the next bank with valid data will be recalled (empty memory banks are skipped).

To scan more than one memory bank at a time, please refer to the scan bank linking **section 7-7** of this manual.

7-5 Channel PASS

When scanning, you may encounter active memory channels which you do not wish to currently monitor. It is possible to manually force the scan process to continue by pressing the **SCAN** key or $\uparrow \downarrow$ keys but this manual intervention can be an annoyance. For this reason it is possible to temporarily PASS

unwanted channels so that they are skipped when scanning. PASS does not delete the memory contents but simply 'tags' the channel to be skipped. In memory read, the PASS tag may be toggled on/off and the tags removed in one operation using the delete pass channel facility of the DELETE menu.

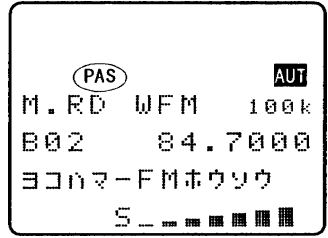

While paused (during scan) on a busy channel which you do not currently wish to monitor, PUSH (PASS) to skip it. The scan process will immediately move on to the next memory channel of the current bank in the direction (up or down) which has been previously used for tuning or memory read. This tagged memory channel will be skipped during subsequent scans until the tag is removed. The legend "PAS" will have been assigned to the skipped memory channel which may be reviewed in memory read mode.

7-5-1 Toggling memory channel PASS

The (PASS) key may also be used to tag (skip) unwanted channels when in memory read. To cancel channel pass tag on a particular memory channel, recall it in memory read mode then PUSH (PASS). The LCD legend "PAS" indicates when the channel is locked out, the (PASS) key toggles "PAS" on/off.

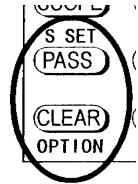

7-5-2 Removing ALL memory PASS tags in one go

It is possible to remove the memory PASS tags of ALL memory channels in all banks in one operation using the DELET menu.

PUSH (F) PRESS (9 IS) to access the DELETE menu. PUSH the ↓ key six times to display the menu option "DEL MEM PASS".

Note: It will take a little while for the AR8200 to look for PROTECT channels and PASS channels as you work through the menus.

If at least one memory channel has been tagged PASS, the third line from the bottom of the LCD will display a memory location such as "PASS-CH A17" with the "A17" simply confirming that at least one memory channel is tagged PASS. If no memory channels have been tagged PASS, the LCD will display "PASS-CH ---".

To remove all memory PASS tags in one go PUSH (PASS), the legend "MEM PASS CH ALL OFF!!" will be displayed to show that removal of pass tags is in process followed by "MEM PASS CH SEARCH !!" as the AR8200 checks that all tags have been removed. The LCD will then display "PASS-CH ---" to confirm that no channels are now tagged as PASS. To exit the menu and return to the standard display PUSH (CLEAR).

7-6 Deleting memory channels

Although it is possible to over-write memory channels with new data, edit memory channels, swap, copy, move and to PASS (skip) them, there will be occasions when you want to delete memory channels completely.

7-6-1 Deleting single memory channels

While in memory read mode, PUSH (F) PUSH (9 IS) to delete the currently displayed memory channel. As a safe guard against accidental deletion you will be instructed to PUSH (ENT) to execute the deletion, alternatively PUSH (CLEAR) to abort delete.

Once memory channels have been deleted, the data is destroyed and cannot be recalled again.

7-6-2 Deleting whole memory banks in one go

Should you wish to delete the entire contents of a memory bank, the DELETE menu may be used, this is quicker than recalling each memory in memory read mode and deleting them individually, especially if there are more than about five or six channels involved.

PUSH (F) PRESS (9 IS) to access the DELETE menu. PUSH the ↓ key three times to display the menu item "DELETE MEM-BANK B00". The LCD will display a memory bank location such as "MEM-BANK B00" with the "B00" being the last memory bank used. Use the ← → ↑ ↓ keys to select the desired memory bank for deletion, alternatively type in the required bank letter via the keypad (the CASE SHIFT key (Aa) will be required to access the lower case memory banks). If there are no channels which contain data in the selected memory bank, the LCD legend "B --" will be displayed with "B" being the current bank and "--" indicating that no channels are available for recall or scan (as they are empty).

To delete all memory channels from the displayed bank PUSH (PASS). After a few seconds the LCD will display "DELETE MEM-BANK B--" indicating that the selected bank no longer contains memory data.

To exit the menu and return to the standard display PUSH (CLEAR).

7-7 Scan bank link (scan group)

It is possible to custom define scan parameters for a single bank or group of memory banks.

Use the key sequence PUSH (F) PUSH (SCAN) to access the "SCAN GROUP" menu. Bank "SCAN GROUP 0" contains a default listing and cannot be overwritten (so displays "LINK OFF" on the bottom line of the LCD), banks 1 to 9 are available for custom programming.

Use the main dial or ← → keys to select the SCAN GROUP number, for SCAN-GROUP numbers 1 to 9 the legend

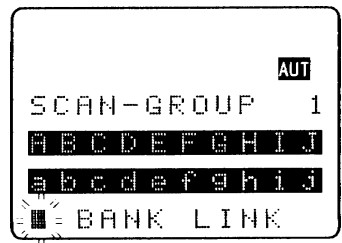

"BANK LINK" will be displayed on the bottom line of the LCD indicating that programming *is* possible.

PUSH ↓ to move to the memory bank letters, then reverse highlight the letters you wish to link together as a group of memory channels to scan using the ⇐ ⇨ ↑ ↓ keys, PUSH (PASS) to mark desired memory banks, both upper and lower case letters may be highlighted in the same group. The selected banks (which will form a large scan group) will be displayed in REVERSE contrast on the LCD.

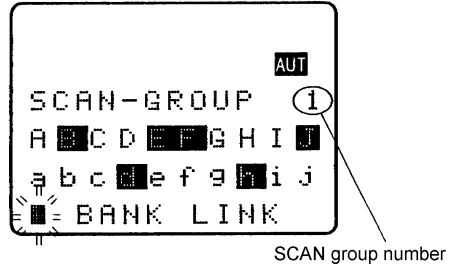

It is also possible to use the keypad to quickly select the required banks for inclusion as a group, this saves having to use (PASS) to toggle selection, The CASE SHIFT key is used to toggle between the upper and lower case memory bank listings.

PUSH (ENT) to accept the data input. PUSH (SCAN) (one or twice) to start scanning if the AR8200 is not already in scan mode. The memory banks grouped together in the SCAN GROUP will form a large group during scan. The SCAN GROUP number (and associated data) will be used to define current scan parameters.

For example: If you group banks "B, E, F, a, h" as SCAN GROUP number "1", then when **any one** of these banks is scanned, all other banks in the group will be scanned in sequence over and over... **B > E > F > a > h > B > E > F > a > h** etc (providing each of the banks contains stored memory channels).

It is possible to scan ANY memory bank, even if it is not contained in the current SCAN GROUP list by manually selecting the bank using the ⇐ ⇨ keys or keypad while in scan mode.

You can individually configure each of the nine SCAN GROUPS 1 to 9 with a different collection of banks. **SCAN GROUP 0 cannot be changed as it contains the default of LINK OFF** so that you can quickly disable bank link when individual memory scan is required. **SCAN GROUP 0 also contains default settings for DELAY, LEVEL, VOICE, FREE and MODE parameters.**

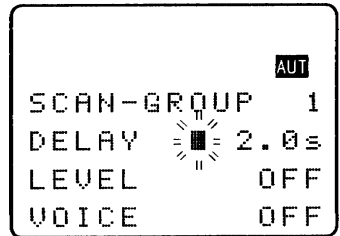

To change the active SCAN GROUP, access the SCAN GROUP menu using the key sequence PUSH (F) PUSH (SCAN),

select the desired SCAN GROUP (0 to 9) using the main dial or ⇐ ⇨ keys then PUSH (ENT) to accept the change and exit the menu.

7-8 Additional scan facilities

(Scan group environment - DELAY, LEVEL, VOICE, FREE, MODE)

It is possible to further customise the scan parameters for each of the nine SCAN GROUPS (group 0 cannot be altered as it contains the default information).

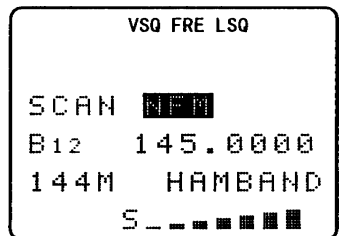

Use the key sequence **PUSH** **PUSH** to access the “**SCAN-GROUP**” menu. Use the \leftrightarrow keys to select the SCAN-GROUP number between **1** and **9**. **PUSH** three times to move down beyond the bank link facility and onto the additional scan environment facilities: delay, level, voice, free, mode scan.

1.	DELAY	OFF / 0.1 - 9.9 seconds (default 2.0s)
2.	LEVEL	OFF / 1 - 255 (default OFF)
3.	VOICE	OFF / 1 - 255 (default OFF)
4.	FREE	OFF / 1 - 60 seconds (default OFF)
5.	MODE	ALL, WFM, NFM, SFM, WAM, AM, NAM, USB, LSB, CW

7-8-1 Scan DELAY

The scan DELAY parameter affects the time the AR8200 will remain on an active frequency in scan mode once the received signal has disappeared and the squelch has closed. This is particularly useful for customising how long the receiver will wait for a reply before resuming scan. For example, when communications are passed back and forth between a control tower / aircraft which may take a few seconds. The limits are OFF and 0.1 to 9.9 seconds in 0.1s increments (default 2.0 seconds).

Scan DELAY is configured via the SCAN-GROUP menu. Use the key sequence **PUSH** **PUSH** to access the “**SCAN-GROUP**” menu. Use the \leftrightarrow keys to select the SCAN-GROUP number between 1 and 9. **PUSH** three times to display the scan environment parameters starting with the DELAY.

PUSH to toggle the status between 2.0s and OFF, the default is 2.0s. Use the main dial to increment delay time in 0.1s or the \leftrightarrow keys to increment in 1.0s.

- 2.0s** The AR8200 will wait the specified time after the squelch closes before scan.
- OFF** The AR8200 will resume scan instantaneously when the squelch closes.

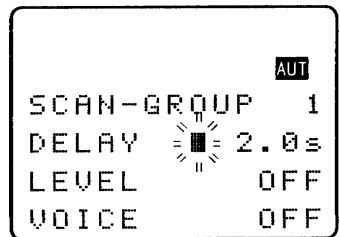



PUSH to accept the changes and return to the display prior to accessing the SCAN environment menu. Alternatively you may move to the next option (scan LEVEL squelch) by pressing the \downarrow key.

7-8-2 Scan LEVEL

The scan LEVEL squelch parameter causes the AR8200 to check the signal strength and to only open the squelch when the signal strength is above the stated level (which is programmable in 256 steps). The limits are OFF and 1 to 255 (default off).

Scan LEVEL is configured via the SCAN-GROUP menu. Use the key sequence **PUSH** **PUSH** to access the “**SCAN-GROUP**” menu.

Use the $\leftarrow \rightarrow$ keys to select the SCAN-GROUP number between 1 and 9. PUSH  \downarrow four times to display the scan environment parameter of LEVEL.

PUSH  **PASS** as a short cut to off (which is the default). Use the main dial to increment value by 1 or use the $\leftarrow \rightarrow$ keys to increment by 10.

While adjusting level squelch, the “★” legend will be displayed to the left of the value “**LEVEL ★ 3**” indicating that the current value will *not* cause the squelch to close. Increase the value until the “★” legend is just extinguished (this may typically be around a value of 120 - 230), the current transmission and signals below this level *will* be skipped. There will be no audio produced when a transmission is encountered below the level configured even though the “S” squelch legend is displayed. This is a useful alternative to regular squelch on noisy bands such as short wave.

The approximate relationship between signal meter segments and level value is as follows:

1	2	3	4	5	6	7	8	9	10	11	12	13	14
124	141	154	168	178	185	193	200	203	206	208	210	212	214

 **Note:** When level squelch is in operation, the rotary squelch control is usually best rotated to the fully anti-clockwise position.



PUSH  **ENT** to accept the changes and return to the display prior to accessing the scan environment menu. Alternatively you may move to the next option (scan VOICE squelch) by pressing the \downarrow key.

While scanning, the LCD legend “**LSQ**” is displayed to indicate that scan LEVEL squelch is in operation.

7-8-3 Scan VOICE

The scan VOICE squelch parameter causes the AR8200 to check the current frequency for valid audio and to only open the squelch when audio above a specified level (which is programmable in 256 steps) is detected. The limits are OFF and 1 to 255 (default off).

Scan VOICE is configured via the SCAN-GROUP menu. Use the key sequence PUSH  **(F)**

PUSH  **SCAN** to access the “**SCAN-GROUP**” menu. Use the $\leftarrow \rightarrow$ keys to select the SCAN-GROUP number between 1 and 9. PUSH  \downarrow five times to display the scan environment parameter of VOICE.

PUSH  **PASS** as a short cut to off (which is the default). Use the main dial to increment value by 1 or use the $\leftarrow \rightarrow$ keys to increment by 10.

While adjusting voice squelch, the “★” legend will be displayed to the left of the value “**VOICE ★ 12**” indicating that the current value will *not* cause the squelch to close. Increase the value until the “★” legend is just extinguished (this may typically be around a value of 1 to 100), the current transmission and signals with audio below this level *will* be skipped. There will be no audio produced when a transmission is encountered with audio below the level configured even though the “S” squelch legend is displayed.

 **Note:** When voice squelch is in operation, the rotary squelch control is usually best rotated to the fully anti-clockwise position.

PUSH  **(ENT)** to accept the changes and return to the display prior to accessing the scan environment menu. Alternatively you may move to the next option (scan FREE time) by pressing the \downarrow key.

While scanning, the LCD legend “**VSQ**” is displayed to indicate that scan VOICE squelch is in operation.

7-8-4 Scan FREE

The scan FREE time parameter determines how long the AR8200 will remain on an **active** frequency before resuming scan even though the frequency is still active. This is useful if you wish to gain a snap shot of activity without the AR8200 being tied to a busy frequency for long periods of time (such as when monitoring active amateur band repeaters etc). Scan FREE time saves you having to manually intervene to force the scan process to resume and saves the need to lockout memory channels using the channel PASS facility. The limits are OFF and 01 to 60 seconds (default OFF).

Scan FREE time is configured via the SCAN-GROUP menu. Use the key sequence **PUSH**  **(F)**

PUSH  **(SCAN)** to access the “**SCAN-GROUP**” menu. Use the $\leftarrow \rightarrow$ keys to select the

SCAN-GROUP number between 1 and 9. **PUSH**  \downarrow six times to display the scan environment parameter of FREE.

PUSH  **(PASS)** to toggle between OFF and 5 seconds (the default is off). Use the main dial to increment value by 1s or use the $\leftarrow \rightarrow$ keys to increment by 5s.

PUSH  **(ENT)** to accept the changes and return to the display prior to accessing the scan environment menu. Alternatively you may move to the next option (scan receive MODE) by pressing the \downarrow key.

While scanning, the LCD legend “**FRE**” is displayed to indicate that scan FREE time is in operation and the scan process will only pause on active frequencies for the specified time.

7-8-5 Scan (receive) MODE

The scan receive MODE parameter enables selected receive modes to be scanned in isolation even though memory banks may contain many different receive modes. This saves the need to lockout memory channels using the channel PASS facility when only a certain receive mode is desired (such as AM for airband monitoring etc).

Scan receive MODE is configured via the SCAN-GROUP menu. Use the key sequence **PUSH**  **(F)**

PUSH  **(SCAN)** to access the “**SCAN-GROUP**” menu. Use the $\leftarrow \rightarrow$ keys to select the

SCAN-GROUP number between 1 and 9. **PUSH**  \downarrow seven times to display the scan environment parameter of MODE.

PUSH (PASS) as a short cut to ALL (which is the default) which will cause all receive modes to be scanned in the specified scan group. Use the main dial or $\leftarrow \rightarrow$ keys to select the receive mode: ALL, WFM, NFM, SFM, WAM, AM, NAM, USB, LSB, CW.

PUSH (ENT) to accept the changes and return to the display prior to accessing the scan environment menu. The \downarrow key loops back to the top of the SCAN-GROUP menu.

While scanning, only memory channels with the corresponding receive mode will be scanned. The legend "SCAN NFM" or "SCAN AM" etc will be displayed indicating that only specific modes will be scanned, the modes are displayed in REVERSE CONTRAST highlighting. If no channel contained within the bank group matches the specified receive mode, the scan will be aborted and the display will return to 2VFO mode with an error beep sounding (if the beep is enabled).

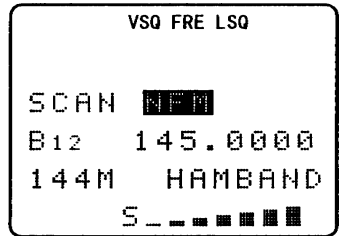

7-8-6 Write protect of memory channels & banks

It is possible to write protect memory channels, whole memory banks, search banks and 'globally protect' memory to prevent data being accidentally over-written. Refer to **section 11** of this manual regarding the write protect options.

7-9 Select scan

Select scan enables you to 'tag' memory channels to make a temporary list of up to 100 channels for scanning in a separate list called the SELECT SCAN LIST. Memory channels from **any** of the 20 memory banks may be mixed together in any order and added to the select scan list.

7-9-1 Adding select scan channels in memory read

In memory read mode or when paused on an active channel in scan mode use the key sequence PUSH (F) PUSH (PASS) to toggle the select scan tag on/off, the legend "SEL" confirms selection. Even memories marked as channel pass may be added to the select scan list, the pass status will be ignored by select scan.

7-9-2 Starting / stopping select scan

To start select scan you must first have at least two memory channels tagged for select scan. PUSH (F) PUSH (5EO) to start select scan. The legend "SEL" will be displayed on the left hand side of the LCD to indicate that select scan is in progress. The memory channels will be displayed as select scan progresses and each memory channel will display the legend "SEL". The direction of scan can be reversed using the main dial or $\uparrow \downarrow$ keys.

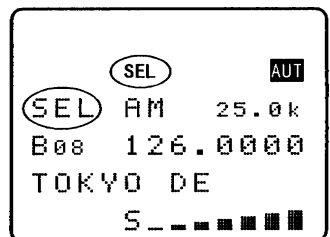

To stop select scan, PUSH (2VFO) or (SCAN) or (SRCH)

7-9-3 Select scan environment

The select scan environment may be customised in respect of DELAY, LEVEL, VOICE, FREE and MODE. The current SCAN-GROUP selection is used by select scan. To access the scan group environment menu **PUSH** **(F)** **PUSH** **(SCAN)**. For further information regarding the scan group environment please refer to **section 7-8** of this manual.

7-9-4 Editing the contents of the select scan list

Although it is possible to review all 1,000 memory channels using memory read to assess which memory channels are tagged for select scan, a quicker method is available via the select scan menu.

PUSH **(F)** **PRESS** **(PASS)** to access the **"SEL-SCAN"** menu.

One hundred select scan channels are available and numbered from 00 to 99. Use the main dial or $\leftarrow \rightarrow$ keys to scroll through the select scan list contents. The select scan numbers are allocated in the order in which they were tagged in memory read mode, the memory bank/channel number, frequency and any text comment is displayed.



Deleting single select scan channels

To remove the displayed channel from the select scan list **PUSH** **(PASS)**. The frequency is removed from display (**"SEL"** tag is removed from the memory channel) and the position in the select scan list will be filled with the next highest select scan channel number. For example, if you have five select channels listed and delete number **"03"**, channel number **"04"** will slide down to take its place (any gap is filled) so that **"04"** will be renumbered as **"03"**, **"05"** will become **"04"** and so on.

Adding new select scan channels

It is possible to tag select scan memories in memory read mode, it is also possible to add additional select scan channels using the select scan menu.

PUSH **(F)** **PRESS** **(PASS)** to access the select scan menu.



PUSH the \leftarrow key to wrap around to the end of the select scan list, the legend **"SEL-SCAN xx - - - - -"** will be displayed where **"xx"** is the next available select scan channel. The 'dashes' indicate that the channel is currently unused.

PUSH \downarrow to display the legend **"BANK/CH SEL"** inviting you to select a memory channel to add to the select scan list.

Select the desired memory channel by keying a three digit location via the keypad or scroll through the memory banks using the $\leftarrow \rightarrow$ keys and main dial to scroll through the memory channels.

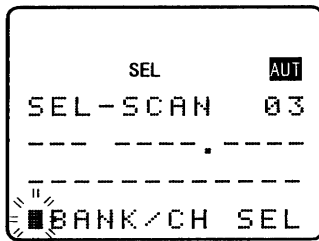
PUSH **(PASS)** to accept the displayed memory location to be added to the select scan list. The memory data will appear alongside the select scan number.





If you wish to add more select scan channels PUSH  ⇨ once to move upward to the *new* end of the list and repeat the process. PUSH  (ENT) or (CLEAR) to exit the select scan menu.

It is possible to delete the entire select scan list in one go using the DELETE menu, this is very useful to enable rapid changes to the select scan list content.

7-9-5 Deleting all select scan channels

Although it is possible to review and delete select scan channels in memory read and by using the select scan menu, a quicker method is available should you wish to delete all select scan tags in one go. This is particularly useful when you wish to start a new select scan list (making the select scan list almost like a note pad).

The DELETE menu is used to delete all select scan channels in one go. To access the delete menu

PUSH  (F) PRESS  (9 IS) PUSH  the ↓ key four times to display the "DELETE SEL-CH" menu. If at least one select scan channel exists, a channel location will be displayed to the right of the legend "SEL-CH Xxx" where "Xxx" represents the channel location, if no select scan channels exist the legend "SEL-CH --" will be displayed.

PUSH  (PASS) to delete the select scan list, the "SEL-CH --" legend confirms deletion.

PUSH  (ENT) or (CLEAR) or (SRCH) or (SCAN) or (2VFO) to exit the delete menu.

 **Note:** Only the select scan 'tags' are deleted using this procedure, the memory channel contents are not erased or altered in any other way.

(8) Search mode

In search mode, the AR8200 is programmed to automatically tune between two specified frequency limits looking for activity. Please refer to **section 1-3** of this manual if you do not fully understand the terminology of SEARCH.

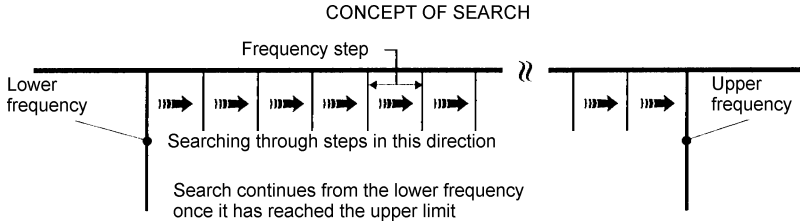

Example: In the case of 20 kHz step size

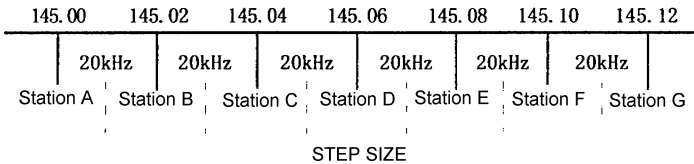

8-1 Search types

The AR8200 is equipped with two types of search:-

VFO SEARCH = search from the current frequency in VFO mode.
Please refer to **section 4-3** of this manual for further information.

PROGRAM SEARCH = search between user programmed limits.

8-1-1 Program search overview

There are 40 program search banks (referred to simply as search banks) which can be programmed with specific parameters:

- LO (lower) start frequency
- HI (upper) stop frequency
- Receive mode (or set to AUTO MODE)
- Receive tuning step (or set to AUTO MODE)
- Step adjust
- Frequency offset
- Attenuator status
- Noise limiter status
- Text comment
- Write protect
- CTCSS tone (if the CT8200 SLOT CARD option is used)

The program search banks are identified by upper case letters **A - T** and lower case letters **a - t**. To help with identification, each bank may be labelled with an alpha-numeric text comment.

To assist testing in the factory, several search banks may be programmed with data (which can be easily deleted or over-written). This pre-programming is useful to ease familiarisation during the early days of operation... so that when you push a key there is something already programmed to work!

8-2 Starting program search

Presuming that data is already stored into a search bank...

PUSH the **SRCH** key to start the program search process. The LCD legend "SRCH" will be displayed and as long as the squelch is closed, the search process will start from the lower frequency limit and will progress toward the upper frequency limit. When the program limit is reached, the search loops around and starts the process again.

Note: If no search banks have been programmed, the search process will not operate.

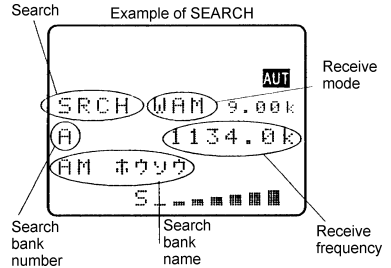
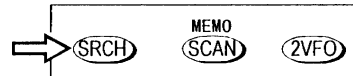

8-2-1 Reversing the direction of search

To reverse the direction of search use the main dial or $\uparrow \downarrow$ keys, this is useful to enable you to search back over and over an interesting point of the search process.

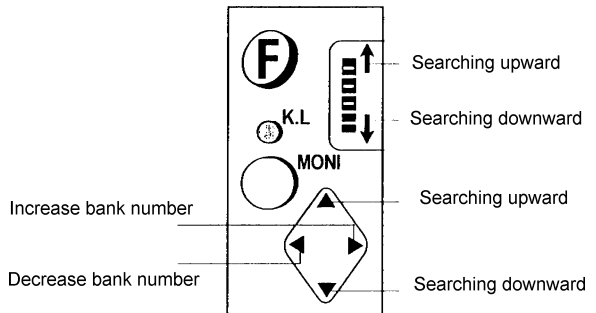

8-2-2 Forcing the search to resume

If the AR8200 stops on an unwanted busy frequency, PUSH the **SRCH** key or use the $\uparrow \downarrow$ keys or main dial to force the search process to resume from the current frequency displayed.

8-2-3 Stopping the search

While the search process is in progress (not stopped), PUSH **SRCH** to stop searching and transfer the current frequency to the single VFO for monitoring or tuning from. To exit the search process PUSH the **SCAN** key for memory read mode or the **2VFO** key for 2VFO mode (displaying the data on-screen before search was started).

8-2-4 Copying an active frequency to the VFO or memory location

It is convenient to transfer an active frequency from search to VFO or memory for periods of extended listening.

Copy to VFO

When the search process is stopped on an active frequency, PUSH the (ENT) key to transfer the current receive frequency to the single VFO where it may be monitored.

Write to memory

When the search process is stopped on an active frequency, PRESS the (ENT) key to write the current receive frequency into the first available empty memory location (or you may select a specific location from the 1,000 memory channels available).

8-3 Selection of search bank

There are 40 search banks, while searching use the ⇐ ⇨ keys to step through search banks which contain data, alternatively you may use the numeric keys (with assigned letters and shifts). If no data is programmed in the nominated search bank, the next bank containing valid data will be used.

Recalling search banks A - J is very simple involving only one key push, for this reason it is suggested that these banks are used for primary search tasks.

While searching, PUSH the numeric key corresponding to the required search bank:

- A* (1 AK)
- B (2 BL)
- C (3 CM)
- D (4 DN)
- E (5 EO)
- F (6 FP)
- G (7 GQ)
- H (8 HR)
- I (9 IS)
- J (0 JT)

(1 AK) PUSH to show flashing bank "A", will be selected after 2 seconds

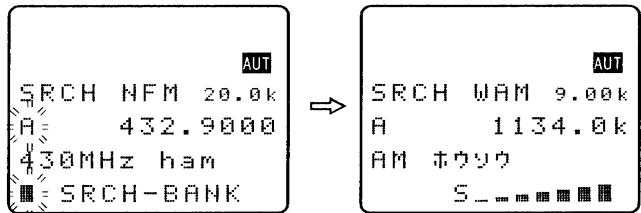

* When bank "A" is selected via the keypad, a delay of around two seconds will be encountered before the (1 AK) key is acted upon, this is because the (1 AK) key also has a special 'SHIFT' command status when selecting banks K - T and k - t.

Tip: to search "A" instantly, PUSH (0 JT) PUSH (1 AK)

Recalling banks **K - T** requires use of the 'SHIFT' command before the letter key, this 'shift'

command is the use of the (1 AK) key before a second numeric key is pushed. **You must key quickly** or bank "A" will be selected, the timeout while using the 'shift' key is around two seconds:

K	(1 AK)	(1 AK)
L	(1 AK)	(2 BL)
M	(1 AK)	(3 CM)
N	(1 AK)	(4 DN)
O	(1 AK)	(5 EO)
P	(1 AK)	(6 FP)
Q	(1 AK)	(7 GQ)
R	(1 AK)	(8 HR)
S	(1 AK)	(9 IS)
T	(1 AK)	(0 JT)

Recalling banks **k - t** requires use of the 'case' and 'shift' command before the letter key:

k	(● Aa)	(1 AK)	(1 AK)
l	(● Aa)	(1 AK)	(2 BL)
m	(● Aa)	(1 AK)	(3 CM)
n	(● Aa)	(1 AK)	(4 DN)
o	(● Aa)	(1 AK)	(5 EO)
p	(● Aa)	(1 AK)	(6 FP)
q	(● Aa)	(1 AK)	(7 GQ)
r	(● Aa)	(1 AK)	(8 HR)
s	(● Aa)	(1 AK)	(9 IS)
t	(● Aa)	(1 AK)	(0 JT)

Recalling banks **a - j** requires use of the 'CASE' command before the letter key, this 'case' command (selecting upper or lower case bank letters) is the use of the (● Aa) key before a second numeric key is pushed.

a	(● Aa)	(1 AK)
b	(● Aa)	(2 BL)
c	(● Aa)	(3 CM)
d	(● Aa)	(4 DN)
e	(● Aa)	(5 EO)
f	(● Aa)	(6 FP)
g	(● Aa)	(7 GQ)
h	(● Aa)	(8 HR)
i	(● Aa)	(9 IS)
j	(● Aa)	(0 JT)

8-4 Programming a search bank

Each of the 40 search banks may be programmed with different frequency limits, receive modes, step size etc as listed in **section 8-1-1** of this manual.

PUSH (F) PUSH (6 FP) to access the "SRCH-PROG" menu.

Use the main dial or $\leftarrow \rightarrow$ keys or keypad to select the bank you wish to program or over write. (The \downarrow key is used to move through the menu).

PUSH \downarrow

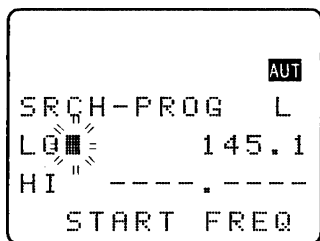

Entering "LO" frequency limit, 145.1

HI Input the higher *end* frequency in MHz format (don't push enter)

PUSH \downarrow

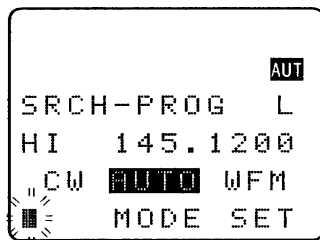

PUSH \downarrow

STEP Assuming that a receive mode other than "AUTO" was selected, you will be presented with the "SET STEP" menu. Use the main dial or $\leftarrow \rightarrow$ keys to select the required tuning step from the following: 0.05 kHz (50 Hz), 0.1 kHz (100 Hz), 0.2 kHz (200 Hz), 0.5 kHz (500 Hz), 1.00 kHz, 2.00 kHz, 5.00 kHz, 6.25 kHz, 8.33 kHz, 9.00 kHz, 10.00 kHz, 12.50 kHz, 20 kHz, 25.00 kHz, 30 kHz, 50 kHz, 100.00 kHz. Alternatively a step size may be entered in kHz format via the keypad in multiples of 50 Hz in the range of 50 Hz to 999.95 kHz (do not push enter).

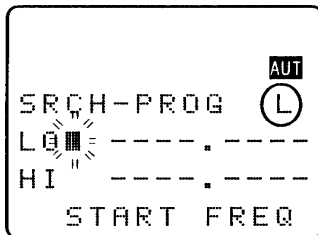
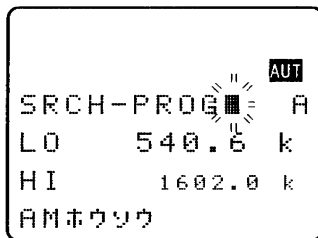

Search bank "L" selected

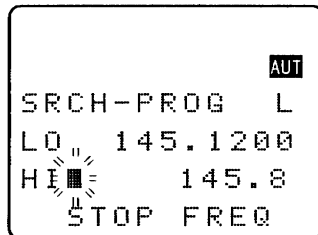

Entering "HI" frequency limit, 145.8

MODE SET Use the $\leftarrow \rightarrow$ keys or main dial to select receive mode, the (PASS) key is used as a short cut to "AUTO".

Note: If the receive mode is set to "AUTO", the receive mode, channel step, step-adjust, frequency offset will be taken from the pre-programmed auto band plan data, for this reason the detailing will not be required while programming so is skipped... the next menu will be TEXT INPUT.

Note: If a step-adjust value is already programmed into the search bank, the step-adjust menu will be automatically displayed when accessing the step input menu.

STEP ADJ+ If you wish to manually enter a step-adjust value for tracking unusual band plans **PUSH** (PASS), the “**STEP ADJ+**” legend will be displayed. **PUSH** ↓ to move the cursor to the “**ADJ+**” line and enter a step-adjust value using kHz format (do not push enter). You can use the ↑ key in this menu to move back to STEP size selection.

Note: Step-adjust value will be calculated automatically by the AR8200 if a manual entry is not made. The CPU calculates if the selected tuning step size is divisible into the search bank start and end frequency limits and sets step-adjust accordingly.

PUSH ↓ to access the TEXT INPUT menu.

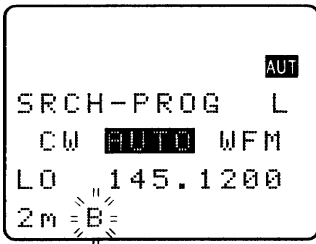

TEXT The cursor will be positioned in the bottom left corner of the LCD. If an unwanted text comment exists **PUSH** (PASS) to delete the character highlighted by the cursor and the remainder of the line to the right of the cursor position. Add text if you wish.

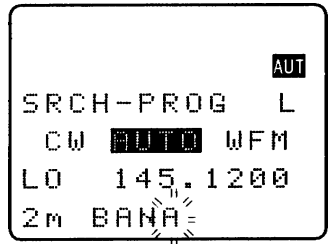

PUSH ↓ to access the PROTECT menu.

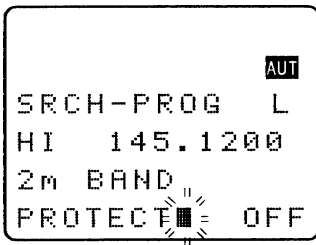

PROTECT It is possible to protect a search bank to prevent accidental over-writing of data. **PUSH** (PASS) to toggle the write protect status on/off (default is off).

To accept the data input **PUSH** (ENT).

Alternatively **PUSH** ↓ to return to the top of the menu or **PUSH** (CLEAR) to abort. The LCD will revert to its previous display (VFO, search or scan mode).

To start SEARCH **PUSH** (SRCH), use the ← → keys or keypad to select search bank.

The attenuator, noise limiter or AFC can be toggled on/off during the search process.

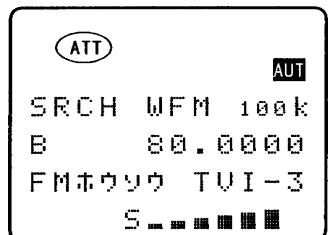

8-5 Locking out unwanted active frequencies (PASS)

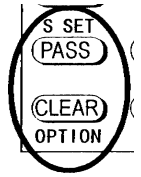

It is possible to lock out (PASS) unwanted frequencies while in program search mode, this is useful to eliminate unwanted permanent transmissions. It is important to understand the PASS facility before using the (PASS) key or transmissions may be missed.

While stopped on an unwanted frequency PUSH (PASS), the search process will resume. It will appear that **all** frequencies are still searched, however locked out frequencies will be 'passed over', the search will not **stop** on locked out frequencies but the squelch may momentarily open causing a short burst of audio before the frequency is passed... if several consecutive active frequencies are locked out, an audio 'chuff... chuff... chuff...' may be encountered.

Locked out PASS frequencies are assigned PASS CHANNEL NUMBERS, there are a total of 50 PASS channels for each search bank. Frequencies ± 10 kHz from the assigned pass frequency will be skipped, carefully consider the implications of locking out ± 10 kHz when using USB, LSB and CW. When you attempt to exceed the limit of 50 pass channels per bank an error beep will be emitted (if beep is enabled). The locked out frequency will be relevant to the current search bank only... i.e. if you lock out 124.500 MHz in search bank "A", this frequency will not be locked out of any other search bank and may be searched as usual in any other bank.

8-5-1 Search pass menu

It is possible to review, delete and add pass channels using the SEARCH PASS menu.

If you are currently searching PRESS (PASS), the "SRCH PASS" menu will be displayed along with current bank letter.

From any other point PRESS (PASS), the VFO-PASS menu will be displayed, PUSH \downarrow to access the "SRCH PASS" menu, use the \leftrightarrow keys at display the desired search bank letter.

If pass channels have already been tagged for the current search bank the legend "PASS xx" will be displayed where "xx" indicates that data is present. If no pass frequencies have been tagged, the legend "PASS 00 ----" will be displayed.

The \leftrightarrow keys, main dial or keypad may be used to change search bank. PUSH the \downarrow key to access the review section of the menu, the frequency pass contents of the displayed bank may be reviewed using the \leftrightarrow keys or main dial.

To delete the displayed pass frequency key in a nul value (0 = zero) PUSH (OJT) (ENT). The frequency pass channel will be deleted and the list will re-shuffle. The frequency is once again available in search mode.

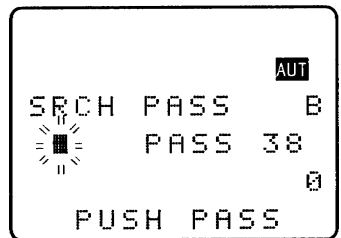
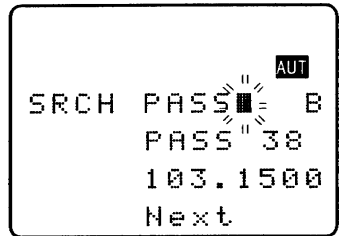



To delete the entire contents of the current search pass list **PUSH**  **(PASS)**, the legend “**PASS 00 ----,----**” confirms deletion. The search pass list may also be deleted using the DELETE menu, refer to **section 10-1** of this manual.

Adding new pass frequencies



Access the search pass list, If you are currently searching **PRESS**  **(PASS)**, the “**SRCH PASS**” menu will be displayed along with current bank letter. From any other point

PRESS  **(PASS)**, the VFO-PASS menu will be displayed,

PUSH  **↓** to access the “**SRCH PASS**” menu, use the **⇐ ⇨** keys at display the desired search bank letter.

PUSH  the **⇨** key to wrap around to the end of the pass frequency list, the legend “**PASS xx ----,----**” will be displayed where “**xx**” is the next available frequency pass channel. The ‘dashes’ indicate that the channel is currently unused.

Key in a frequency which you wish to skip during search of the current bank using MHz format and ending with **(ENT)**.



PUSH  the **⇨** key and repeat the process if you wish to add further frequencies to be skipped. To accept the data entry and exit the menu **PUSH**  **(ENT)**. This facility is particularly useful if you know what frequencies are unwanted prior to searching, such as constant carriers etc.

 **Note:** You may add frequencies in the range of 100 kHz to 2400 MHz via this menu but only those within the current search limits will be acted upon.

It is also possible to delete the entire frequency pass list using the DELETE menu, refer to **section 10-1** of this manual.

8-6 Search bank link

It is possible to custom define search parameters for a single bank or group of search banks.

Use the key sequence **PUSH**  **(F)** **PUSH**  **(SRCH)** to access the “**SRCH GROUP**” menu. Bank “**SRCH GROUP 0**” contains a default listing and cannot be overwritten (so displays “**LINK OFF**” on the bottom line of the LCD), banks 1 to 9 are available for custom programming.

Use the main dial or **⇐ ⇨** keys to select the SEARCH GROUP number, for SEARCH GROUP numbers **1 to 9** the legend “**BANK LINK**” will be displayed on the bottom line of the LCD indicating that programming **is** possible.

PUSH  **↓** to move to the search bank letters **A - T** and **a - t**, use the **↑ ↓** keys to move between upper and lower case letters.

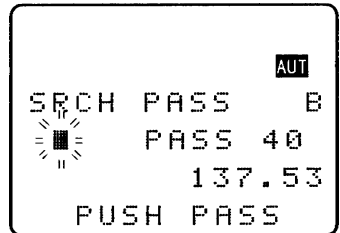
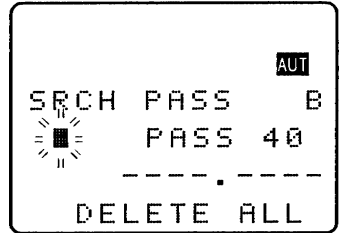

Next reverse highlight the letters you wish to link together as a group using the \leftrightarrow \updownarrow keys, PUSH $\left(\text{PASS}\right)$ to mark the desired search banks, both upper and lower case letters may be highlighted in the same group. The selected banks (which will form a large group) will be displayed in REVERSE contrast on the LCD.

It is also possible to use the keypad to quickly select the required banks for inclusion as a group, this saves having to use $\left(\text{PASS}\right)$ to toggle selection, The CASE SHIFT key $\left(\bullet \text{Aa}\right)$ is used to toggle between the upper and lower case and the SHIFT key $\left(\text{1 AK}\right)$ is used to access letters between K - T and k - t.

PUSH $\left(\text{ENT}\right)$ to accept the data input.

PUSH $\left(\text{SRCH}\right)$ to start searching (if the AR8200 is not already in search mode). The banks grouped together in the SEARCH GROUP will form a large group during search. The SEARCH GROUP number (and associated data) will be used to define current program search parameters.

For example: If you group banks "A, B, E" as SCAN GROUP number "1", then when **any one** bank is searched, all other banks in the group will be searched in sequence over and over... A > B > E > A > B > E > A > B > E etc (providing each of the banks contains search program data).

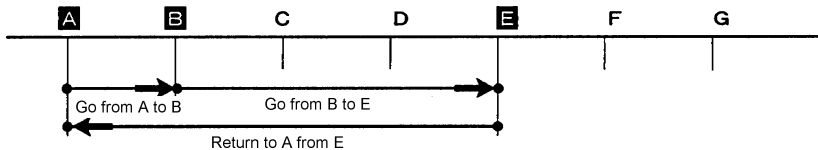

It is possible to search ANY bank, even if it is not contained in the current SEARCH GROUP list by manually selecting the bank using the \leftrightarrow \updownarrow keys or keypad while in search mode.

You can individually configure each of the nine SEARCH GROUPS 1 to 9 with a different collection of banks. **SEARCH GROUP 0 cannot be changed as it contains the default of LINK OFF** so that you can quickly disable bank link when you wish to search only one bank. SEARCH GROUP 0 also contains default settings for DELAY, LEVEL, VOICE and FREE parameters.

To change the active SEARCH GROUP, access the SEARCH GROUP menu using the key sequence PUSH $\left(\text{F}\right)$ PUSH $\left(\text{SRCH}\right)$, select the desired SEARCH GROUP (0 to 9) using the main dial or \leftrightarrow \updownarrow keys then PUSH $\left(\text{ENT}\right)$ to accept the change and exit the menu.

8-7 Additional search facilities

(Search group environment - DELAY, LEVEL, VOICE, FREE, AUTO STORE, DELETE J).

It is possible to further customise the search parameters for each of the nine SEARCH GROUPS (group 0 cannot be altered as it contains the default information).

Use the key sequence PUSH $\left(\text{F}\right)$ PUSH $\left(\text{SRCH}\right)$ to access the "SRCH-GROUP" menu. Use the \leftrightarrow \updownarrow keys to select a SRCH-GROUP number between 1 and 9. PUSH $\left(\downarrow\right)$ five times to move down beyond the bank link facility and onto the additional search environment facilities: delay, level, voice, free, auto store and delete J.

Example of SEARCH including AUTO MODE "AUT"

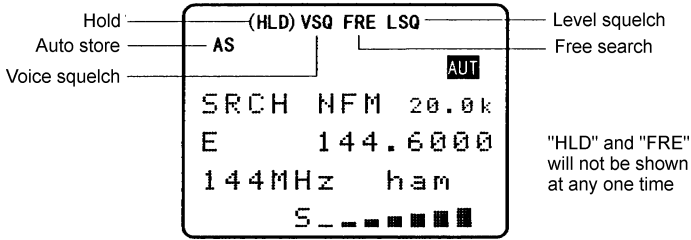

1.	DELAY	OFF / HOLD / 0.1 - 9.9 seconds (default 2.0s)
2.	LEVEL	OFF / 1 - 255 (default OFF)
3.	VOICE	OFF / 1 - 255 (default OFF)
4.	FREE	OFF / 1 - 60 seconds (default OFF)
5.	AUTO STORE	ON / OFF (default OFF)
6.	DELETE J	Yes / No (using PASS key)

8-7-1 Search DELAY

The search DELAY parameter affects the time the AR8200 will remain on an active frequency in search mode once the received signal has disappeared and the squelch has closed. This is particularly useful for customising how long the receiver will wait for a reply before resuming search. For example, when communications are passed back and forth between a control tower / aircraft which may take a few seconds. The limits are OFF / HOLD and 0.1 to 9.9 seconds in 0.1s increments (default 2.0 seconds).

Search DELAY is configured via the SRCH-GROUP menu. Use the key sequence **PUSH** **F**

PUSH **SRCH** to access the "SRCH-GROUP" menu. Use the **↔** keys to select the SRCH-GROUP number between 1 and 9. **PUSH** **↓** five times to display the search environment parameters starting with the DELAY.



PUSH **PASS** to toggle the status between 2.0s / HOLD / OFF, the default is 2.0s. Use the main dial to increment delay time in 0.1s or the **↔** keys to increment in 1.0s.

- 2.0s** The AR8200 will wait the specified time after the squelch closes before resuming search.
- HOLD** The AR8200 will stop indefinitely when an active frequency is located, this is very useful when you don't want to miss that once-in-a-lifetime transmission!
- OFF** The AR8200 will resume search instantaneously when the squelch closes.

PUSH **ENT** to accept the changes and return to the display prior to accessing the SEARCH environment menu. Alternatively you may move to the next option (search LEVEL squelch) by pressing the **↓** key.

8-7-2 Search LEVEL

The search LEVEL squelch parameter causes the AR8200 to check the signal strength and to only open the squelch when the signal strength is above the stated level (which is programmable in 256 steps). The limits are OFF and 1 to 255 (default off).

Search LEVEL is configured via the SRCH-GROUP menu. Use the key sequence **PUSH**  **(F)** **PUSH**  **(SRCH)** to access the “**SRCH-GROUP**” menu. Use the $\leftarrow \rightarrow$ keys to select the SRCH-GROUP number between **1** and **9**. **PUSH**  six times to display the search environment parameter of LEVEL.

PUSH  **(PASS)** as a short cut to off (which is the default). Use the main dial to increment value by 1 or use the $\leftarrow \rightarrow$ keys to increment by 10.

While adjusting level squelch, the “★” legend will be displayed to the left of the value “**LEVEL ★ 3**” indicating that the current value will *not* cause the squelch to close. Increase the value until the “★” legend is just extinguished (this may typically be around a value of 120 - 230), the current transmission and signals below this level *will* be skipped. There will be no audio produced when a transmission is encountered below the level configured even though the “**S**” squelch legend is displayed. This is a useful alternative to regular squelch on noisy bands such as short wave.

The approximate relationship between signal meter segments and level value is as follows:

1	2	3	4	5	6	7	8	9	10	11	12	13	14
124	141	154	168	178	185	193	200	203	206	208	210	212	214



 **Note:** When level squelch is in operation, the rotary squelch control is usually best rotated to the fully anti-clockwise position.

PUSH  **(ENT)** to accept the changes and return to the display prior to accessing the search environment menu. Alternatively you may move to the next option (search VOICE squelch) by pressing the \downarrow key.

While searching, the LCD legend “**LSQ**” is displayed to indicate that search LEVEL squelch is in operation.

8-7-3 Search VOICE

The search VOICE squelch parameter causes the AR8200 to check the current frequency for valid audio and to only open the squelch when audio above a specified level (which is programmable in 256 steps) is detected. The limits are OFF and 1 to 255 (default off).

Search VOICE is configured via the SRCH-GROUP menu. Use the key sequence **PUSH**  **(F)** **PUSH**  **(SRCH)** to access the “**SRCH-GROUP**” menu. Use the $\leftarrow \rightarrow$ keys to select the SRCH-GROUP number between **1** and **9**. **PUSH**  seven times to display the search environment parameter of VOICE.

PUSH  (PASS) as a short cut to off (which is the default). Use the main dial to increment value by 1 or use the ⇐ ⇒ keys to increment by 10.

While adjusting voice squelch, the “★” legend will be displayed to the left of the value “VOICE ★ 12” indicating that the current value will *not* cause the squelch to close. Increase the value until the “★” legend is just extinguished (this may typically be around a value of 1 to 100), the current transmission and signals with audio below this level *will* be skipped. There will be no audio produced when a transmission is encountered with audio below the level configured even though the “S” squelch legend is displayed.

 **Note:** When voice squelch is in operation, the rotary squelch control is usually best rotated to the fully anti-clockwise position.



PUSH  (ENT) to accept the changes and return to the display prior to accessing the search environment menu. Alternatively you may move to the next option (search FREE time) by pressing the ↓ key.

While searching, the LCD legend “VSQ” is displayed to indicate that search VOICE squelch is in operation.

8-7-4 Search FREE

The search FREE time parameter determines how long the AR8200 will remain on an **active** frequency before resuming search even though the frequency is still active. This is useful if you wish to gain a snap shot of activity without the AR8200 being tied to a busy frequency for long periods of time (such as when monitoring active amateur band repeaters etc). Search FREE time saves you having to manually intervene to force the search process to resume and saves the need to lockout (PASS) busy frequencies. The limits are OFF and 01 to 60 seconds (default OFF).

Search FREE time is configured via the SRCH-GROUP menu. Use the key sequence PUSH  (F)

PUSH  (SRCH) to access the “SRCH-GROUP” menu. Use the ⇐ ⇒ keys to select the SRCH-GROUP number between 1 and 9. PUSH  ↓ eight times to display the search environment parameter of FREE.

PUSH  (PASS) to toggle between OFF and 5 seconds (the default is off). Use the main dial to increment value in by 1s or use the ⇐ ⇒ keys to increment by 5s.



PUSH  (ENT) to accept the changes and return to the display prior to accessing the search environment menu. Alternatively you may move to the next option (AUTO STORE) by pressing the ↓ key.

While searching, the LCD legend “FRE” is displayed to indicate that search FREE time is in operation and the search process will only pause on active frequencies for the specified time.

8-7-5 AUTO STORE

Auto store causes the first 50 active frequencies located during search to be automatically written to **memory bank "J"** (channels J00 to J49). If bank "J" is full, auto store will not function.

 **Note:** Memory banks are dynamically configurable so that bank "J" has 50 channels at default but may be configured to provide 10, 20, 30, 40, 50, 60, 70, 80, or 90 channels. Refer to **section 5-7** of this manual regarding dynamic memory bank resizing.

Search auto store is configured via the SRCH-GROUP menu. Use the key sequence **PUSH**  **F** **PUSH**  **SRCH** to access the "SRCH-GROUP" menu. Use the $\leftarrow \rightarrow$ keys to select the SRCH-GROUP number between **1** and **9**. **PUSH**  \downarrow nine times to display the search environment parameter of AUTO STORE.



PUSH  **PASS** to toggle between OFF and ON (the default is off).

PUSH  **ENT** to accept the changes and return to the display prior to accessing the search environment menu. Alternatively you may move to the next option (DELETE J) by pressing the \downarrow key.

While searching, the LCD legend "AS" is displayed to indicate that auto store is in operation. Frequencies closer than ± 10 kHz to a frequency already stored in bank "J" will be ignored, this prevents the same frequency being stored over and over again. As busy frequencies are located and entered automatically into memory bank "J", any associated search bank text comment will also be stored into memory to help identify from which search bank the frequencies originated.

8-7-6 DELETE bank "J"

To simplify the VFO auto store feature, it is possible to delete the contents of memory bank "J" using this menu... this allows you to quickly 'dump' the unwanted contents of the auto store memory bank "J" before starting a new search with the auto store feature enabled.

'DELETE J' is configured via the SRCH-GROUP menu. Use the key sequence **PUSH**  **F** **PUSH**  **SRCH** to access the "SRCH-GROUP" menu. Use the $\leftarrow \rightarrow$ keys to select the SRCH-GROUP number between **1** and **9**. **PUSH**  \downarrow ten times to display the search environment parameter of **DELETE J**.

If bank "J" contains data, the legend "J00" will be displayed, if no data is held in bank "J" the legend "J --" will be displayed. **PUSH**  **PASS** to delete the contents of bank "J", this will take a few sections to action by the CPU. The legend "J --" will be displayed to confirm deletion.

PUSH  **ENT** to return to the display prior to accessing the VFO environment menu.

8-7-7 Deleting search banks

A delete menu is provided so that you can delete program search data (of course you may simply over-write the data too) and frequency pass channels. You cannot delete search banks which have been write protected.

While in search mode, the **DELETE menu** is accessed using the key sequence **PUSH**  **(F)**

PUSH  **(9 IS)**. (While in SCAN or VFO mode use the key sequence **PUSH**  **(F)**)

PRESS  **(9 IS)** and use \leftarrow \rightarrow to select the required search bank).

The **"HI"** and **"LO"** frequency limits will flash on the LCD along with any associated text comment to aid the identification of the required search bank. To delete the program search data

PUSH  **(PASS)**, the legend "----,----" confirms data deletion.

PUSH  **(ENT)** to exit the menu returning to the standard

display, alternatively **PUSH**  \downarrow to move to the **"DEL PASS"** selection point.

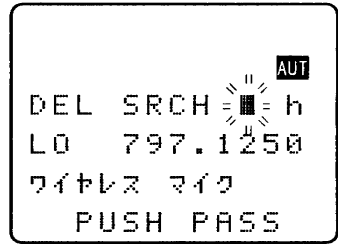

When deleting program search data, the associated FREQUENCY PASS channels are not deleted just in case you wish to go back to the same programming at a later date, after all they will be ignored if a different frequency range is programmed into program search for this bank. With this in mind, you may leave regularly used pass frequencies relating to several frequency ranges in the bank to save reprogramming at a later date when different program search ranges are used (there are a total of 50 pass frequencies per bank and are only acted when searching the current bank).

If frequency pass channels exist for the current bank, the legend **"DEL PASS xx"** will be displayed with the **"xx"** number (**00 to 49**) indicating that data is present. If no data is present the legend **"DEL PASS --"** will be displayed. To delete the frequency pass data **PUSH**  **(PASS)**, the legend **"DEL PASS --"** confirms deletion.

PUSH  **(ENT)** to exit the menu returning to the standard display.

8-7-8 Write protect and copying search banks

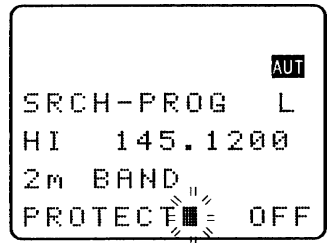

It is possible to write protect search banks to prevent accidental deletion of stored data, this is accomplished using the **EDIT menu**. It is also possible to copy search data from one bank to another using the same menu. Refer to **sections 9-7 & 9-3** of this manual regarding the write protect and copy options.



(9) EDIT menu



The EDIT menu is a powerful feature which simplifies the management of data and provides the following operations:

COPY MEM-CH	loads one memory channel to save to another location
COPY MEM-BNK	loads one whole memory bank to save to another location
COPY SEARCH	loads one search bank to save to another location
MOVE MEM-CH	loads one memory channel to save to another location leaving the original memory location blank
SWAP MEM-CH	swaps the data of two memory channels with each other
EDIT MEM-CH	enables the contents of a memory channel to be changed including mode, step, frequency, text comment and write protect
MEM PROTECT	enables you to toggle the write protect status of memory channels
SRCH PROT	enables you to toggle the write protect status of search banks

The edit menu is called with the key sequence **PUSH**  **(F)** **PUSH**  **(8 HR)**

9-1 EDIT COPY memory channel

The COPY MEMORY CHANNEL menu enables you to make an exact copy of one memory bank into another bank location, the original memory bank is left intact and completely unaffected. Due to dynamic memory bank resizing, it is possible that the highest channel number in any memory bank could be in the range of 09 to 89 (default is 49).

The “**COPY MEM-CH**” menu is accessed using the key sequence **PUSH**  **(F)** **PUSH**  **(8 HR)**.

Two data input lines are presented **LOAD** and **SAVE**.

The cursor will be positioned on the **LOAD** line. “**LOAD**” represents the memory channel which you would like to make a copy of (this is the data you want). Use the main dial to select channel number and the $\leftarrow \rightarrow$ keys to select bank, alternatively type in a three digit memory location via the keypad.

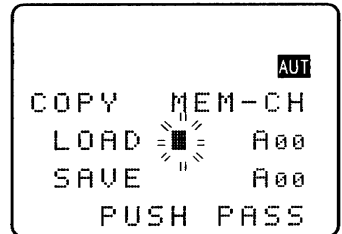



PUSH  \downarrow to move to the **SAVE** line. “**SAVE**” is the target memory location where data is to be written. Use the main dial to select channel number and the $\leftarrow \rightarrow$ keys to select bank, alternatively type in a three digit memory location via the keypad.

PUSH  **(PASS)** to copy the memory channel data to the target location. Both **LOAD** and **SAVE** displayed memory channel locations revert to **LOAD** location.

The process may be repeated for other locations.

 **Note:** If the SAVE location is write protected, the legend **"PROTECT"** will be displayed. You must remove write protect from the SAVE memory location before you can copy new data to that location. You may remove the write protection for one or all memory channels, refer to **sections 11-1 & 11-5** of this manual.



PUSH  (ENT) to exit the menu returning to the standard display, alternatively PUSH  ↓ to move to the **"COPY MEM-BNK"** selection point.

9-2 EDIT COPY memory bank

The COPY MEMORY BANK menu enables you to make an exact copy of one memory bank into another location, the original memory bank is left intact and completely unaffected.

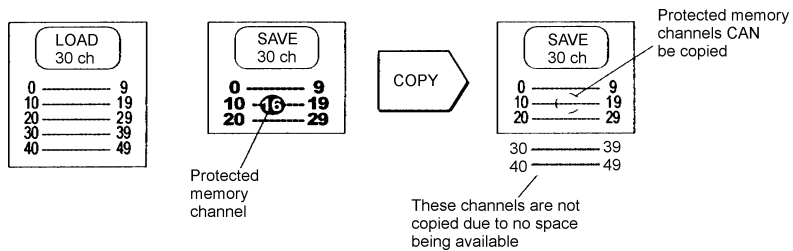
Due to dynamic bank resizing, it is possible to write a large memory bank into a small memory bank location, in this case an exact copy of bank is not possible and data will be lost from the target bank. For example, if BANK "A" has 80 channels and the target BANK "e" has only 20 channels available, the last 60 channels will be lost. If banks are the same size (at default all banks are 50 channels in size) then no data will be lost and exact copies of memory banks will be made.



The **"COPY MEM-BNK"** menu is accessed using the key sequence PUSH  (F) PUSH  (8 HR).

PUSH  the ↓ key twice to move the cursor to the **"COPY MEM-BNK"** selection point. Two data input lines are presented LOAD and SAVE.

The cursor will be positioned on the **LOAD** line. **"LOAD"** represents the memory bank which you would like to make a copy of (this is the data you want). Use the main dial or ⇐ ⇨ keys to select bank, alternatively type in the required bank via the keypad.



PUSH  ↓ to move to the **SAVE** line. **"SAVE"** is the target bank location where data is to be written.

Use the main dial or ⇐ ⇨ keys to select bank, alternatively type in the required bank via the keypad (the load and save bank locations must be different).

PUSH  (PASS) to copy the memory bank data to the target location, the legend **"MEM BANK COPY !!"** will be displayed, after a few seconds both LOAD and SAVE displayed memory bank locations revert to LOAD location.



The process may be repeated for other locations.

 **Note:** If the SAVE bank location is write protected, the legend “**PROTECT**” will be displayed. You must remove write protect from the SAVE memory bank before you can copy new data to that location, individual memory channel write protect is ignored. Refer to the write protect **section 11** of this manual.

PUSH  (ENT) to exit the menu returning to the standard display, alternatively PUSH  ↓ to move to the “**COPY SEARCH**” selection point.

9-3 EDIT COPY search bank

The COPY SEARCH BANK menu enables you to make an exact copy of one search bank into another location, the original search bank is left intact and completely unaffected.

The “**COPY SEARCH**” menu is accessed using the key sequence PUSH  (F) PUSH  (8 HR).

PUSH  the ↓ key four times to move the cursor to the “**COPY SEARCH**” selection point. Two data input lines are presented LOAD-BNK and SAVE-BNK.



The cursor will be positioned on the **LOAD-BNK** line. “**LOAD**” represents the search bank which you would like to make a copy of (this is the data you want). Use the main dial or ⇐ ⇒ keys to select bank, alternatively type in the required bank via the keypad.

PUSH  ↓ to move to the **SAVE-BNK** line. “**SAVE**” is the target bank location where data is to be written. Use the main dial or ⇐ ⇒ keys to select bank, alternatively type in the required bank via the keypad (the load and save locations must be different).

PUSH  (PASS) to copy the search bank data to the target location, both LOAD and SAVE displayed search bank locations revert to LOAD location.



The process may be repeated for other locations.

 **Note:** If the SAVE location is write protected, the legend “**PROTECT**” will be displayed. You must remove write protect from the SAVE search bank before you can copy new data to that location. Refer to the write protect **section 11** of this manual.

PUSH  (ENT) to exit the menu returning to the standard display, alternatively PUSH  ↓ to move to the “**MOVE MEM-CH**” selection point.

9-4 EDIT MOVE memory channel

The MOVE MEMORY CHANNEL menu enables you to make an exact copy of one memory bank into another bank location while leaving the original memory empty (data is erased). Due to dynamic memory bank resizing, it is possible that the highest channel number in any memory bank could be in the range of 09 to 89 (default is 49).

The “**MOVE MEM-CH**” menu is accessed using the key sequence PUSH  (F) PUSH  (8 HR).

PUSH  the ↓ key six times to move the cursor to the “**MOVE MEM-CH**” selection point.

Two data input lines are presented LOAD and SAVE.

The cursor will be positioned on the **LOAD** line. "**LOAD**" represents the memory channel which you would like to move (this is the data you want). Use the main dial to select channel number and the $\leftarrow \rightarrow$ keys to select bank, alternatively type in a three digit memory location via the keypad.

PUSH \downarrow to move to the **SAVE** line. "**SAVE**" is the target memory location where data is to be written. Use the main dial to select channel number and the $\leftarrow \rightarrow$ keys to select bank, alternatively type in a three digit memory location via the keypad.

PUSH (PASS) to move the memory channel data to the target location.

Both LOAD and SAVE displayed memory channel locations revert to LOAD location. The memory channel data will have moved from the LOAD to SAVE locations and the original LOAD location will be empty (contents deleted). It is even possible to move empty memory locations!

The process may be repeated for other locations.

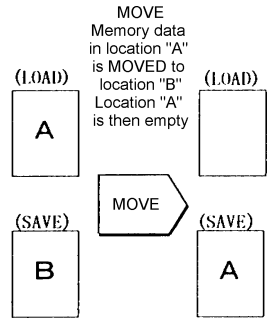

Note: If the SAVE location is write protected, the legend "**PROTECT**" will be displayed. You must remove write protect from the SAVE memory location before you can move new data to that location. You may remove the write protection for all memory channels in one go, refer to **section 11** of this manual.

PUSH (ENT) to exit the menu returning to the standard display, alternatively PUSH \downarrow to move to the "**SWAP MEM-BNK**" selection point.

9-5 EDIT SWAP memory channel

The SWAP MEMORY CHANNEL menu enables you to make an exact copy of one memory bank into another bank location while simultaneously copying the data from the target location back to the original memory location.... This means in effect that both channels are load and both are save. For this reason the legends "**CH-A**" and "**CH-B**" are used, both having equal status. Due to dynamic memory bank resizing, it is possible that the highest channel number in any memory bank could be in the range of 09 to 89 (default is 49).

The "**SWAP MEM-CH**" menu is accessed using the key sequence PUSH (F) PUSH (8 HR).

PUSH the \downarrow key eight times to move the cursor to the "**SWAP MEM-CH**" selection point. Two data input lines are presented CH-A and CH-B.

The cursor will be positioned on the **CH-A** line. Use the main dial to select channel number and the $\leftarrow \rightarrow$ keys to select bank, alternatively type in a three digit memory location via the keypad.

PUSH \downarrow to move to the **CH-B** line. Use the main dial to select channel number and the $\leftarrow \rightarrow$ keys to select bank, alternatively type in a three digit memory location via the keypad.

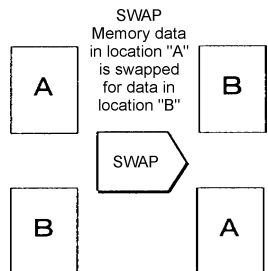

PUSH (PASS) to swap the memory channel data between CH-A and CH-B. Both CH-A and CH-B display the memory channel location of CH-A.

The process may be repeated for other locations.

Note: If either location is write protected, the legend “**PROTECT**” will be displayed. You must remove write protect from the memory location before you can swap new data to that location. You may remove the write protection for all memory channels in one go, refer to **section 11** of this manual.

PUSH (ENT) to exit the menu returning to the standard display, alternatively PUSH ↓ to move to the “**EDIT MEM-CH**” selection point.

9-6 EDIT memory channel

The EDIT MEMORY CHANNEL menu enables you to make the following changes to memory channel data:

- Receive mode
- Tuning step including step-adjust
- Receive frequency
- Text comment
- Write protect

The “**EDIT MEM-CH**” menu is accessed using the key sequence PUSH (F) PUSH (8 HR) PUSH the ↓ key ten times to move the cursor to the “**EDIT MEM-CH**” selection point.

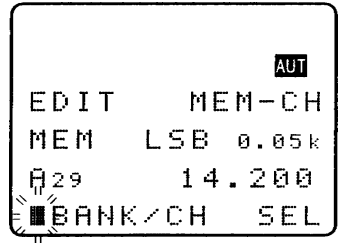

A memory channel will be displayed, this will usually be the last channel accessed in memory read mode. If you desire a different memory channel location, use the main dial to select channel number and the ⇐ ⇒ keys to select bank, alternatively type in a three digit memory location via the keypad.

If the memory channel is **write protected**, the legend “**PROTECT**” will be displayed. You must remove write protect from the memory location before you can edit the memory channel data. A short cut to the memory channel “**PROTECT**” menu is provided when you first access the edit memory channel menu. PUSH ↓ to move to the “**EDIT MEM-CH PROTECT**” selection point, toggle the protect OFF using the (PASS) key then PUSH ↑ to return to the “**EDIT MEM-CH**” menu from where you started. The write protect menu is also available as you progress through the “**EDIT MEM-CH**” menu so that you may protect the new data as the last step of memory channel editing.

Important note: You **MUST** reconfirm the required channel location even if the correct channel is displayed when the menu is assessed as the ↓ key will otherwise act as a short cut to the “**MEM PROTECT**” menu. The easiest way to reconfirm memory location is to rotate the main dial one click then back again.

PUSH  ↓ to move to the "MODE SET" line. Use the main dial or ⇐ ⇒ keys to select receive mode.

The (PASS) key may be used as a short cut to "AUTO". In auto, receive mode & tuning step will be read from the pre-programmed auto band plan data.

PUSH  ↓ to move to the "SET STEP" line. Use the main dial or ⇐ ⇒ keys to select the tuning step size or via the keypad in kHz format (don't push enter). The (PASS) key may be used to access the STEP-ADJUST menu.

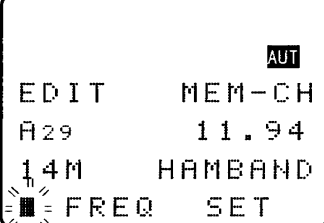

PUSH  ↓ to move to the "FREQ SET" line. The receive frequency may be overwritten in MHz format using the keypad (don't push enter).



PUSH  ↓ to move to the "TEXT SET" line. Use the main dial, ⇐ ⇒ keys and keypad to select new text (remember that the (PASS) key can be used to delete existing text from the cursor position to the end of the line to the right).

PUSH  ↓ to move to the "PROTECT" line. Use the main dial or ⇐ ⇒ keys or (PASS) key to toggle write protect status on/off (default is off).





PUSH  (ENT) to accept the data and exit the menu returning to the standard display, alternatively PUSH  ↓ twice to move to the "SRCH PROT" selection point.

9-7 EDIT Search protect

The SEARCH PROTECT menu enables you to toggle write protect for each search bank to prevent accidental deletion of data. The search protect menu is the last entry of the EDIT menu. PUSH  (F)

PUSH  (8 HR) to access the edit menu then PUSH  the ↓ key twelve times to move the cursor to the "SRCH PROT" selection point.

The cursor will be positioned on the upper line of the display. Use the main dial or ⇐ ⇒ keys to select the required search bank, alternatively type in the required bank via the keypad. PUSH  (PASS) to toggle the write protect status on/off (default off). The process may be repeated for other locations.

PUSH  (ENT) to exit the menu returning to the standard display, alternatively PUSH  ↓ to loop to the top of the edit menu displaying "COPY MEM-CH".

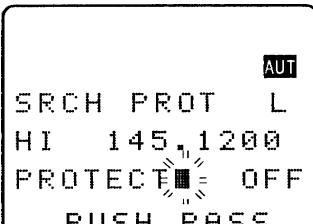

(10) DELETE menu facilities

It is often desirable to delete many data entries in one go such as memory channels and pass frequencies. To assist with data management a DELETE menu is provided which offers the following facilities:-

DEL SRCH	delete a search bank
DEL SRCH PASS	delete the search pass frequencies
DELETE VFO PASS	delete the VFO pass frequencies
MEM-BANK	delete complete memory banks
SEL-CH	delete all select scan channels
PRO-CH	delete the write protect status of memory channels
MEM PASS	delete the pass status of all memory channels

The delete menu is accessed using the key sequence **PUSH** **(F)** **PRESS** **(9 IS)**.

10-1 DELETE search banks and search PASS frequencies

The DELETE SEARCH menu enables complete search banks to be deleted in one simple operation. This makes the new entry of program search information straight forward rather than overwriting existing program search data (especially if step-adjust etc has been employed).

While in search mode, the DELETE menu is accessed using the key sequence **PUSH** **(F)**

PUSH **(9 IS)**, (while in SCAN or VFO mode use the key sequence **PUSH** **(F)**)

PRESS **(9 IS)** with “DEL SRCH” being the first item. Use the main dial, ⇐ ⇒ keys or keypad to select the desired search bank from the 40 available **A - T** and **a - t**. Search banks which are write protected cannot be deleted, you must remove the protection first.

The “HI” and “LO” frequency limits will flash on the LCD along with any associated text comment to aid identification of bank.

To delete the program search data **PUSH** **(PASS)**, the legend “----,----” confirms data deletion.

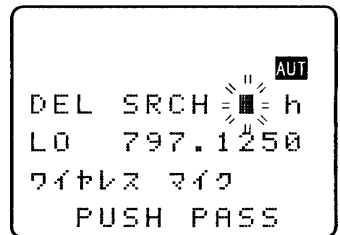

PUSH **(ENT)** to exit the menu returning to the standard display, alternatively **PUSH** **↓** to move to the “DEL PASS” selection point.



When deleting program search data, the associated FREQUENCY PASS channels are not deleted just in case you wish to go back to the same programming at a later date, after all they will be ignored if a different frequency range is programmed into program search for this bank. With this in mind, you may leave regularly used pass frequencies relating to several frequency ranges in the bank to save reprogramming at a later date when different program search ranges are used (there are a total of 50 pass frequencies per bank and are only acted upon when searching the **associated** bank).





If frequency pass channels exist for the current bank, the legend “**DEL PASS xx**” will be displayed with the “**xx**” number (**00** to **49**) indicating that data is present. If no data is present the legend “**DEL PASS --**” will be displayed. To delete the frequency pass data **PUSH**  **(PASS)**, the legend “**DEL PASS --**” confirms deletion.

 **Note:** When searching, an empty search bank will cause the next search bank containing valid data to be recalled.



PUSH  **(ENT)** to exit the menu returning to the standard display, alternatively **PUSH**  **↓** to move to the next item in the menu “**DELETE VFO PASS**”.

10-2 DELETE VFO PASS

It is possible to delete all VFO frequency pass channels using the DELETE menu (also possible in the VFO PASS menu accessed by **PRESS**  **(PASS)**, refer to **section 4-3-4** of this manual).





While in search mode, the DELETE menu is accessed using the key sequence **PUSH**  **(F)**
PUSH  **(9 IS)**, (while in SCAN or VFO mode use the key sequence **PUSH**  **(F)**
PRESS  **(9 IS)**). **PUSH**  the **↓** key twice to move the cursor to the “**DELETE VFO-PASS**” selection point.

If VFO-PASS channels exist, the legend “**VFO-PASS xx**” will be displayed with the “**xx**” number (**00** to **49**) indicating that data is present. If no data is present the legend “**VFO-PASS --**” will be displayed. To delete VFO-PASS data **PUSH**  **(PASS)**, the legend “**VFO-PASS --**” confirms deletion.

PUSH  **(ENT)** to exit the menu returning to the standard display, alternatively **PUSH**  the **↓** key to move to the next item in the menu “**DELETE MEM-BANK**”.



10-3 DELETE memory bank

The DELETE MEMORY BANK menu enables complete memory banks to be deleted in one simple operation.

While in search mode, the DELETE menu is accessed using the key sequence **PUSH**  **(F)**
PUSH  **(9 IS)**, (while in SCAN or VFO mode use the key sequence **PUSH**  **(F)**
PRESS  **(9 IS)**). **PUSH**  the **↓** key three times to move the cursor to the “**DELETE MEM-BANK**” selection point.







Use the main dial, **↔** **↔** keys or keypad to select the desired memory bank from the 20 available **A - J** and **a - j**. Memory banks which are write protected cannot be deleted, you must remove the protection first, even a single protected memory channel in the displayed memory bank will prevent deletion. You may remove the write protection for all memory channels in one go, refer to **section 11** of this manual.

If no memory data exists in the selected memory bank, the legend "**MEM-BANK X--**" will be displayed. If memory data does exist, the legend "**MEM-BANK Xxx**" will be displayed with the "**xx**" number (00 to 89) indicating that data is present. To delete MEM-BANK data **PUSH**  **(PASS)**, the legend "**MEM-BANK Xxx**" confirms deletion.

PUSH  to exit the menu returning to the standard display, alternatively **PUSH**  the  key to move to the next item in the menu "**DELETE SEL-CH**".



10-4 DELETE select scan channels

It is possible to delete all SELECT SCAN channel 'tags' using the DELETE menu.

While in search mode, the DELETE menu is accessed using the key sequence **PUSH** 
PUSH , (while in scan or VFO mode use the key sequence **PUSH**  **PRESS** 
PUSH  the  key four times to move the cursor to the "**DELETE SEL-CH**" selection point.







If SELECT SCAN channels exist, the legend "**SEL-CH xx**" will be displayed with the "**xx**" number (00 to 99) indicating that data is present. If no select scan channels exist the legend "**SEL-CH --**" will be displayed. To delete all select scan channels **PUSH**  **(PASS)**, the legend "**SEL-CH --**" confirms deletion.

If even a single select scan channel is write protected, the select scan bank cannot be deleted, you must remove the protection first. You may remove the write protection for all memory channels in one go, refer to **section 11** of this manual.



PUSH  to exit the menu returning to the standard display, alternatively **PUSH**  the  key to move to the next item in the menu "**CH PROTECT**".

10-5 DELETE memory channel protect

It is possible to remove the write protection from all memory channels in one go using the DELETE menu.

While in search mode, the DELETE menu is accessed using the key sequence **PUSH** 
PUSH , (while in SCAN or VFO mode use the key sequence **PUSH** 
PRESS ). **PUSH**  the  key five times, the LCD will temporarily display "**MEM PROTECT CH SEARCH !!**" as the AR8200 checks to see which memory channels are write protected (if any). The menu selection "**CH PROTECT**" will be displayed after a few seconds.



If any memory channels are write protected, the legend "**PRO-CH xx**" will be displayed with the "**xx**" number (00 to 89) indicating that data is present. If no memory channels are write protected, the legend "**PRO-CH --**" will be displayed. To remove all memory channel write protection **PUSH**  **(PASS)**, the legend "**PRO-CH --**" confirms deletion. The memory channels are not affected other than the protect status being switched off.

PUSH  (ENT) to exit the menu returning to the standard display, alternatively PUSH  the ↓ key to move to the next item in the menu “DEL MEM PASS”.

10-6 DELETE memory channel pass

It is possible to remove the channel pass ‘tags’ from all memory channels in one go using the DELETE menu.

While in search mode, the DELETE menu is accessed using the key sequence PUSH  (F)

PUSH  (9 IS), (while in SCAN or VFO mode use the key sequence PUSH  (F)

PRESS  (9 IS), PUSH  the ↓ key six times.

 **Note:** The LCD will temporarily display “MEM PROTECT CH SEARCH !!” after the fifth push (this takes a few seconds to clear) then push ↓ for the sixth time the LCD will temporarily display “MEM PASS CH SEARCH !!” as the AR8200 checks to see which memory channels have PASS tags (if any).

The menu selection “DEL MEM PASS” will be displayed after a few seconds.

If any memory channels are tagged PASS, the legend “PASS-CH xx” will be displayed with the “xx” number (00 to 99) indicating that data is present. If no memory channels are tagged PASS, the legend “PASS-CH --” will be displayed. To delete all memory channel PASS tags PUSH  (PASS), the legend “PASS-CH --” confirms deletion.

If even a single memory channel is write protected, the PASS tags cannot be deleted, you must remove the protection first. You may remove the write protection for all memory channels in one go, refer to **sections 10-5 & 11** of this manual.

PUSH  (ENT) to exit the menu returning to the standard display.

(11) Write protect

It is possible to write protect memory channels, whole memory banks, search banks and 'globally protect' memory to prevent data being accidentally over-written.

11-1 Memory CHANNEL write protect

It is possible to protect memories while writing new data, toggle the protect status of previously stored memory channels and to delete all memory channel protect tags in one go.

11-2 Write protect during memory input

While in VFO mode, select a frequency then PRESS (ENT) to access the memory input menu. Key in a three digit location for memory storage or use the ⇄ ⇄ keys to select bank and main dial to select channel number. PUSH ↓ to move to the text input menu, add text as desired using the ⇄ ⇄ keys to move the position left and right, (PASS) blanks the line from the current character to the right. PUSH ↓ to move on to CHANNEL

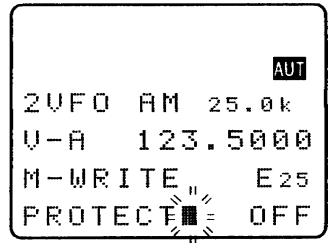

PROTECT. The (PASS) key or the ⇄ ⇄ keys may be used toggle write protect status on/off (default is off). When protect is ON, the memory channel cannot be overwritten while entering new memories or when copying, swapping and moving specific memory channels.

11-3 Channel protect status for existing memory channels

Existing memory channel write protect status may also be toggled on/off via the **EDIT menu**.

PUSH (F) PUSH (8 HR) to access the edit menu. PUSH the ↓ key ten times to display the "EDIT MEM-CH" menu. Key in a three digit location to recall the desired memory channel or use the ⇄ ⇄ keys to select bank and main dial to select channel number. PUSH the ↓ key four times (passing through MODE SET, FREQ SET, TEXT SET and on to PROTECT. The (PASS) key or the ⇄ ⇄ keys may be used toggle write protect status on/off (default is off). PUSH (ENT) to save the changes and exit the menu.

PROTECT - Quick method for several channels





If the required memory channel is recalled in memory read mode, you may move directly to the PROTECT menu using the following key strokes: PUSH (F) PUSH (8 HR) to access the edit menu. PUSH the ↓ key eleven times to display the "MEM PROTECT" menu (the memory channel just recalled will be displayed). The (PASS) key is used toggle write protect status on/off. It is still possible to select other memory channels by keying in a three digit location to recall the desired memory channel or use the ⇄ ⇄ keys to select bank and main dial to select channel number.

Again use the **(PASS)** key to toggle write protect status on/off... in this manner you may quickly change the protect status of several memory channels. **PUSH**  **(ENT)** to save the changes and exit the menu.

 **Note:** Channel write protect is ignored when copying complete memory banks or when copying ALL data.



11-4 Channel protect delete





It is possible to remove all channel protect tags in one go, this allows you to return the AR8200 to a known state of operation if you have mixed many facilities together and unexpected results have been encountered. The DELETE menu is used to delete all memory channel protect tags.

PUSH  **(F)** **PRESS**  **(9 IS)** to access the DELETE menu. **PUSH**  the \downarrow key five times to access the "**CH PROTECT**" menu used to delete all channel protect tags in one go. If protected channels exist the legend "**PRO-CH A00**" will be displayed with "**A00**" being an example to illustrate that channel protect tags have been located. **PUSH**  **(PASS)** to delete channel protect tags in one go, the legend "**MEM PROTECT CH ALL OFF !!**" indicates that deletion of tags is in progress followed by "**MEM PROTECT SEARCH !!**" indicating that the CPU is checking that all tags have been removed. The legend "**CH PROTECT ---**" indicates that there are no memory channels tagged as write protect.

 **Note:** No memory channels are deleted, only the write protect tags are removed from all channels in one go.

11-5 Memory BANK write protect

It is also possible to write protect a whole memory bank, this prevents accidental deletion of data when resizing memory banks. The memory bank write protect may be toggled on/off using the SCAN environment menu accessed by the key sequence **PUSH**  **(F)** **PRESS**  **(SCAN)**, the legend "**M-BANK**" is displayed.

Both upper and lower case letters are displayed as memory banks are treated as a 'pair'. Use the keypad, main dial or \leftrightarrow keys to select the memory bank for which you wish to amend protect status. **PUSH**  the \downarrow key four times to access the "**BANK PROTECT**" menu. Use the \uparrow \downarrow keys to toggle between upper and lower case banks. **PUSH**  **(PASS)** to toggle bank protect on/off (or use the main dial or \leftrightarrow keys). **PUSH**  **(ENT)** to accept the changes and exit the menu (alternatively **PUSH**  **(CLEAR)** to abort).

 **Note:** Memory bank write protect is ignored when loading ALL DATA using the optional EM8200 slot card.

11-6 Search bank write protect

It is possible to write protect individual search banks to prevent accidental deletion. The search bank write protect may be toggled on/off using the **EDIT menu**.

PUSH (F) PUSH (8 HR) to access the edit menu.

PUSH the ↓ key twelve times to display the “SRCH PROT” menu. Select the desired search bank letter via the keypad, main dial or ⇐ ⇨ keys.

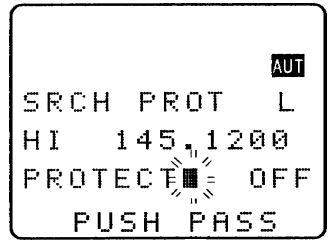

To select the lower case bank letters, the **CASE SHIFT key**

must be used.

For example: To select search bank “h” (presuming it has been previously programmed) PUSH PUSH (8 HR).

To select bank “K - T” the **SHIFT key** must be used.

For example: To select bank “N” (presuming it has been previously programmed) PUSH quickly followed by PUSH (4 DN), you only have 2 seconds to PUSH a key following the use of the SHIFT key or bank “A” will be used.

To select lower case banks “k - t” both the CASE SHIFT and SHIFT keys must be used.

For example: To select bank “m” use the key sequence PUSH PUSH (1 AK) PUSH (3 CM). Remember, you only have 2 seconds to PUSH a key following the use of the SHIFT key or bank “a” will be used in this example.

The key is used to toggle search bank write protect status on/off (default is off).

PUSH to save the changes and exit the menu.

Note: Search bank write protect is ignored when loading ALL DATA using the optional EM8200 slot card.

11-7 Global write protect

For the ultimate in write protection a GLOBAL facility is available. This will ensure that casual users of the AR8200 will not be able to enter, delete or edit any current data within the AR8200, even the optional EM8200 will not be able to load data into the radio.

The main CONFIGURATION (CONFIG) menu is used to toggle the global write protect status on/off.

To access the CONFIG menu PUSH (F) PUSH (7 GQ). PUSH the ↓ key nine times to display “WRITE PROT” with the cursor flashing to the left hand side of this legend. PUSH or use the main dial or ⇐ ⇨ keys to toggle global write protection on/off (default is off). PUSH to accept the changes and exit the menu.

(12) TEXT search and input

It is possible to add text comments (using a maximum of 12 characters) to:-

1. individual memory channels
2. memory banks
3. search banks

This aids later identification of stored data. It is also possible to TEXT SEARCH the AR8200 to automatically hunt for matching text, a minimum of 2 characters are required for TEXT SEARCH, in practical terms a minimum of 3 characters are recommended and the more characters used, the faster the resultant search.

12-1 Text input menus

When in text menus, the ⇐ ⇒ keys are used to move cursor position left and right.

The **(PASS)** key is used to delete the current character and remaining line to the right of the cursor

The MAIN DIAL cycles through upper / lower case letters, numbers and characters.

The numeric keys provide short cuts to several characters:

- | | |
|---------------|---|
| (1 AK) | is a short cut for BLANK |
| (2 BL) | is a short cut for number 1 |
| (3 CM) | is a short cut for upper case A |
| (4 DN) | is a short cut for upper case Z |
| (5 EO) | is a short cut for lower case a |
| (6 FP) | is a short cut for lower case z |
| (7 GQ) | is a short cut for Japanese character set |
| (8 HR) | is a short cut for Japanese character set |
| (9 IS) | is a short cut for various characters & symbols |



PUSH  **(ENT)** to accept the input and return to the standard display.

Short cut text input

It is also possible to add text by 'short cut' in a similar way to personal pagers. If you PRESS  the **(F)** key a 'FLASHING CURSOR' will be displayed. **It is strongly suggested that you refer to sections 13-2 and 13-3 of this manual regarding alternative short cut forms of text input.**

12-2 Text search

For fastest text search and greatest reliability, place the AR8200 into memory read, scan or search mode (it takes a long time while in VFO mode and may fail under certain circumstances). Text search may take up to 30 seconds to complete.

PUSH  (F) PUSH  (ENT) to access the text search menu "TEXT SET". Use (PASS) to clear the existing entry then **input the text to search for**, PUSH  (ENT) to search. The display will show "TEXT xxx SEARCH !!" to show that a search is in progress with "xxx" representing the text being searched for.

The first located matching text will be displayed with the memory channel recalled and displayed or search bank recalled & displayed. The process may be repeated to find additional matching text.

(13) SHORT CUT keys

There are various short cut key combinations available for use with the 'FLASHING FUNCTION'.

When the "FUNC" legend is flashing, two keys are held simultaneously to provide a short cut to specific functions which would otherwise require greater key presses or use of a menu.

13-1 Short cut menu access

PRESS (F) to activate the **flashing function**

legend "FUNC" then refer to the table which is valid only WHILE THE "FUNC" LEGEND IS FLASHING:-

Search short cuts

PRESS (F) for flashing "FUNC" cursor then:

SRCH +	SRCH-GROUP menu
SRCH +	SRCH-GROUP DELAY
SRCH +	SRCH-GROUP LEVEL
SRCH +	SRCH-GROUP VOICE
SRCH +	SRCH-GROUP FREE
SRCH +	SEARCH AUTO STORE

VFO short cuts

PRESS (F) for flashing "FUNC" cursor then:

2VFO +	VFO-MODE DELAY
2VFO +	VFO-MODE LEVEL
2VFO +	VFO-MODE VOICE
2VFO +	VFO-MODE FREE
2VFO +	VFO-MODE QUICK MEMORY

Scan, search, edit, delete short cuts

PRESS (F) for flashing "FUNC" cursor then:

+	COPY MEM-BNK
+	COPY SEARCH
+	MOVE MEM-CH
+	SWAP MEM-CH
+	EDIT MEM-CH
+	MEM PROTECT
+	SRCH PROT

SCAN short cuts

PRESS (F) for flashing "FUNC" cursor then:

SCAN +	SCAN-GROUP menu
SCAN +	SCAN-GROUP DELAY
SCAN +	SCAN -GROUP LEVEL
SCAN +	SCAN -GROUP VOICE
SCAN +	SCAN -GROUP FREE
SCAN +	SCAN-GROUP MODE SCAN
SCAN +	MEMORY BANK TEXT
SCAN +	M-BANK resizing menu
SCAN +	BANK PROTECT

Configuration menu short cuts

PRESS (F) for flashing "FUNC" cursor then:

+	LAMP
+	LCD CONTRAST
+	POWER-SAVE
+	AUTO PWR-OFF
+	REMOTE BPS
+	FREQ DISP
+	WRITE PROTECT (global)
+	OPENING MESSAGE

Delete short cuts

PRESS (F) for flashing "FUNC" cursor then:





+	DELETE VFO-PASS
+	DELETE MEM-BANK
+	DELETE SEL-CH
+	CH PROTECT
+	DEL MEM PASS

13-2 Short cut text entry

Entering text into memory channels, memory banks and search banks can be quite long winded. To speed up the process, while the "FUNC" legend is flashing **two keys may be pushed in sequence** to provide a short cut a variety of alphabet letters (upper case), numbers and symbols. This method of text entry is consistent with that used by PERSONAL PAGERS.

While in a text input menu, PRESS  (F) to display the for flashing "FUNC" then refer to the following table. Look for the required character in the table then PUSH the key shown to the horizontal-left followed by the vertical key shown above the required character (do not push both keys together). The first key push will produce a character on the screen which will be replaced with the required character when the second key is pushed, the cursor will then move one place to the right.

		2. PUSH this key second									
		(1AK)	(2BL)	(3CM)	(4DN)	(5EO)	(6FP)	(7GO)	(8HR)	(9IS)	(0JT)
1. PUSH this key first	(1AK)	ア	イ	ウ	エ	オ	A	B	C	D	E
	(2BL)	カ	キ	ク	ケ	コ	F	G	H	I	J
	(3CM)	サ	シ	ス	セ	ソ	K	L	M	N	O
	(4DN)	タ	チ	ツ	テ	ト	P	Q	R	S	T
	(5EO)	ナ	ニ	ヌ	ネ	ノ	U	V	W	X	Y
	(6FP)	ハ	ヒ	フ	ヘ	ホ	Z	?	!	-	/
	(7GO)	マ	ミ	ム	メ	モ	¥	&			
	(8HR)	ヤ	ユ	ヨ	ヨ	ヨ	*	#	_		
	(9IS)	ラ	リ	ル	レ	ロ	1	2	3	4	5
	(0JT)	ワ	ヰ	ン	ヽ	ヱ	6	7	8	9	0

Example: To select the letter "H" PRESS  (F) until the flashing "FUNC" is displayed. PUSH  (2 BL), the number "2" will be displayed, PUSH  (8 HR), the desired "H" character will be displayed and the cursor will move one position to the right. The flashing "FUNC" legend will continue to flash, if it is not required further PUSH  (F) for it to be removed from the LCD.

13-3 Short cut text entry, keypad with ⇐⇨⇧⇩ keys

Text may also be entered using a combination of the keypad and ⇐⇨⇧⇩ keys.



While in a text input menu, PRESS  (F) for flashing "FUNC" legend then refer to the following table.

Look for the required character in the table then PUSH the key shown to the horizontal-left followed by the ⇐⇨⇧⇩ key shown above the required character (do not push both keys together). The first key push will produce a character on the screen which will be replaced with the required character when the second key is pushed, the cursor will then move one place to the right.





 **Note:** The CASE SHIFT  key is used to access lower case letters.

		2. PUSH this key second			
		➡	⬆	⬅	⬇
1. PUSH this key first	(1AK)	1	A/a	K/k	U/u
	(2BL)	2	B/b	L/l	V/v
	(3CM)	3	C/c	M/m	W/w
	(4DN)	4	D/d	N/n	X/x
	(5EO)	5	E/e	O/o	Y/y
	(6FP)	6	F/f	P/p	Z/z
	(7Gq)	7	G/g	Q/q	ö
	(8HR)	8	H/h	R/r	ü
	(9IS)	9	I/i	S/s	&
	(0JT)	0	J/j	T/t	_

Example: To select the letter "N" PRESS  (F) until the flashing "FUNC" is displayed.

PUSH  (4 DN), the number "4" will be displayed, PUSH  ⇐, the desired "N" character will be displayed and the cursor will move one position to the right. The flashing "FUNC" legend will continue to flash, if it is not required further PUSH  (F) for it to be removed from the LCD.

Example: To select the letter "e" PRESS  (F) until the flashing "FUNC" is displayed.

PUSH  (5 EO), the number "5" will be displayed, PUSH   to instruct the CPU that a lower case letter is required (CASE SHIFT) PUSH  ⇧, the desired "e" character will be displayed and the cursor will move one position to the right. The flashing "FUNC" legend will continue to flash, if it is not required further PUSH  (F) for it to be removed from the LCD.

(14) Configuration menu

The configuration (CONFIG) menu is used to set fundamental operating parameters and other variables which do not appear in any other menu heading.

BEEP	Confirmation & error tone
LAMP	LCD & keypad illumination
CONTRAST	LCD contrast adjustment
POWER-SAVE	Delay & cycle power save
AUTO PWR-OFF	Auto inactivity power off
REMOTE BPS	RS232 baud rate
RMT-ID	Computer control address
FREQ DISP	Frequency readout on/off
WRITE PROT	Global write protect
OPENING MESSAGE	Change the power-up message

14-1 CONFIG BEEP

The AR8200 emits confirmation 'beeps' while the keypad and side keys are used. A 'HIGH' pitched beep indicates correct operation while a 'LOW' pitched beep indicates that an error or unexpected entry has taken place. The volume of the beep is independent of the main volume control and can be separately defined. It is recommended that the beep facility be enabled, especially in the early days while gaining familiarity of the receiver.

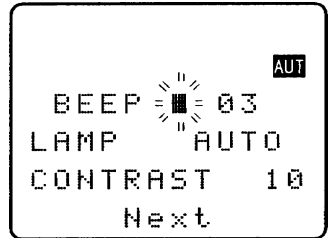

Beep is setup in the CONFIG menu. To access the config menu PUSH (F) PUSH (7GQ). The first item in the config menu is "BEEP", the default is **beep on** with a volume level of 09. Use the main dial or $\leftarrow \rightarrow$ keys to vary beep level between the range of OFF and 01 to 09 with 09 being the loudest. The (PASS) key may be used as a short cut to 05.

PUSH (ENT) to accept the data and return to a standard display. Alternatively PUSH (CLEAR) to abort entry or PUSH (down arrow) to move to the next item on the config menu (LAMP).

14-2 CONFIG LAMP

The AR8200 is equipped with high intensity green LEDs to illuminate the LCD and front panel keypad when operating in areas of low level lighting.

While the AR8200 is switched on and connected to an external power source such as the charger or d.c. lead, the lamp will be PERMANENTLY ON and cannot be switched off. The lamp will go out when the AR8200 is switched off (when the batteries are being charged etc).

The lamp may be configured in three ways:

AUTO







This setting is relevant when operating from internal batteries only. The lamp will automatically illuminate when the front panel and side panel keys are used. The lamp will remain illuminated for a further five second after the last key push and will then switch off. This is a good compromise setting for best visibility and battery life.



CONT

This setting is relevant when operating from internal batteries only. The lamp will CONTinuously illuminate the front panel and side panel keys. The lamp will only extinguish when the AR8200 is switched off. Of course continuous operation of the lamp will drain the internal batteries more quickly.

OFF

This setting is relevant when operating from internal batteries only. The lamp remains permanently extinguished, this is useful to maintain maximum battery life when used in areas of high light levels.





The LAMP is setup in the CONFIG menu. To access the config menu **PUSH**  **PUSH** . **PUSH**  to move the cursor to the "LAMP" selection point. Use the main dial or   keys to toggle the lamp between AUTO (default), CONT and OFF. The  key may be used as a short cut to AUTO.



PUSH  to accept the data and return to a standard display. Alternatively **PUSH**  to abort entry or **PUSH**  to move to the next item on the config menu (CONTRAST).

14-3 CONFIG CONTRAST

The AR8200 is equipped with variable LCD contrast which is adjustable in 32 steps to provide best visibility under different viewing angles, extremes of ambient light & temperature (and between sets due to variation).

The default setting for contrast is 14. The display generally becomes too dark to read around 20 and too faint around 02, the  key may be used as a short cut to 14.

The CONTRAST is setup in the CONFIG menu. To access the config menu **PUSH**  **PUSH** . **PUSH**  twice to move the cursor to the "CONTRAST" selection point. Use the main dial or   keys to vary the contrast level to achieve best visibility.

PUSH  to accept the data and return to a standard display. Alternatively **PUSH**  to abort entry or **PUSH**  to move to the next item on the config menu (POWER-SAVE).

14-4 CONFIG Power save

The POWER SAVE facility may be used to help the receiver to operate for longer periods of time between battery recharging. Power save is default OFF to prevent confusion while the AR8200 is in a "dormant" cycle as the receiver is effectively asleep and only wakes up for short periods to check for activity before going to sleep and becoming dormant again.

 **Note:** While in a dormant state (waiting to cycle), the AR8200 behaves sluggishly.

When power save is ON, the AR8200 will automatically switch 'off and on' but the display will appear permanently on as only the AR8200 "receive" circuitry is switched off and on (switching the receiver off for short periods of time is what saves power!), the microprocessor is left on permanently but in a reduced operating condition.

When activated, two parameters may be varied to affect the way the receiver behaves, these are "DELAY" and "CYCLE".

DELAY: This parameter determines how long the AR8200 will remain active before going to sleep and becoming dormant and is timed from when the squelch last closed or keypad was last used. The available range is 01 to 30 seconds plus OFF (default off). When OFF, the power save does not operate. The **(PASS)** key may be used as a short cut to OFF.



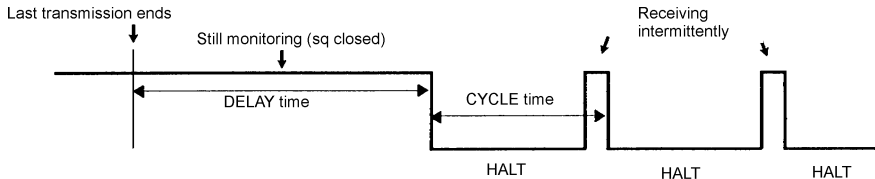

CYCLE: When the receiver becomes dormant (delay has expired), the cycle parameter determines how long the AR8200 will remain dormant before its 'wake up' period begins. If a transmission takes place while dormant it will be missed, if however a transmission occurs during the wake up period, the AR8200 will continue to monitor until the transmission ends and DELAY / CYCLE takes place again. The available range is 0.5 to 9.5 seconds (default 3.0 seconds). The **(PASS)** key may be used as a short cut to 3.0 seconds.



DELAY: Time between the last signal ended and the power save started

CYCLE: The time between 'wake up' monitoring periods

The POWER SAVE parameters are setup in the CONFIG menu. To access the config menu

PUSH  (F) PUSH  (7GQ). PUSH  three times to move the cursor to the POWER SAVE "DELAY" selection point. Use the main dial or   keys to vary the delay value, the **(PASS)** key may be used as a short cut to OFF.

PUSH  to move the cursor to the POWER SAVE "CYCLE" selection point.

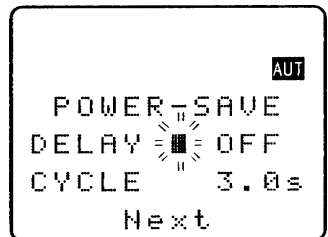

Use the main dial or $\leftarrow \rightarrow$ keys to vary the cycle value, the **(PASS)** key may be used as a short cut to 3.0 seconds.

PUSH **(ENT)** to accept the data and return to a standard display. Alternatively **PUSH** **(CLEAR)** to abort entry or **PUSH** \downarrow to move to the next item on the config menu (AUTO PWR-OFF).

14-5 CONFIG Auto power off

An auto power off facility is available to switch the AR8200 off automatically after a programmable period of squelch inactivity, this prevents the batteries from becoming flat when monitoring a completely inactive frequency.

Note: Be careful how you use auto power off as it might catch you out one day (if a short auto-power-off period has been set), auto power off setting is not cancelled with power off / on... if the AR8200 appears to switch itself off for no reason, check to make sure that you haven't enabled auto power off (there is no associated LCD legend).

AUTO POWER OFF is setup in the CONFIG menu. To access the config menu **PUSH** **(F)** **PUSH** **(7GQ)**. **PUSH** \downarrow five times to move the cursor to the "AUTO PWR-OFF" selection point. Use the main dial or $\leftarrow \rightarrow$ keys to vary the time between 0.5 hours to 9.5 hours in 0.5 hr increments, the **(PASS)** key may be used as a short cut to OFF.

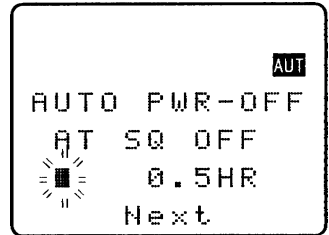

When the AR8200 squelch closes, the CPU will wait the length of time programmed in auto-power-off before automatically switching the AR8200 off. If the squelch opens again before auto switch off time has elapsed, the radio will not power down and the counter will be reset (i.e. an open squelch defeats auto power off).

PUSH **(ENT)** to accept the data and return to a standard display. Alternatively **PUSH** **(CLEAR)** to abort entry or **PUSH** \downarrow to move to the next item on the config menu (REMOTE BPS).

14-6 CONFIG REMOTE BPS

The REMOTE BPS menu is used to configure the RS232 computer control settings as it is important that they exactly match those of an associated computer connection or another AR8200 (connected via the option socket and optional leads).

The REMOTE BPS parameters are setup in the CONFIG menu.

To access the config menu **PUSH** **(F)** **PUSH** **(7GQ)**.

PUSH \downarrow six times to move the cursor to the "REMOTE BPS" selection point. Use the main dial or $\leftarrow \rightarrow$ keys to vary the RS232 baud rate between 4800bps, 9600bps and 19200bps. The

(PASS) key may be used as a short cut to the default of 9600bps.

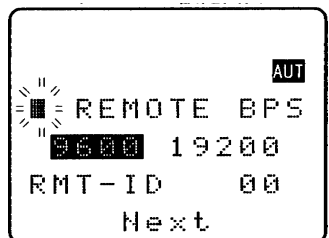

PUSH ↓ to move the cursor to the “RMT-ID” selection point. Use the main dial or ⇐ ⇒ keys change the AR8200 RS232 IDENTIFICATION ADDRESS when multiple units are connected to the same port. It is possible to connect up to 99 units at once, each radio being assigned a different address. The value is adjustable between 00 and 99, the default is 00. The (PASS) key may be used as a short cut 00.

Important note: It is extremely important to set the RMT-ID to 00 for normal operation of the RS232 connection and clone of data between radios.

PUSH (ENT) to accept the data and return to a standard display. Alternatively PUSH (CLEAR) to abort entry or PUSH ↓ to move to the next item on the config menu (FREQ DISP).

14-7 CONFIG FREQ DISP

It is possible to instruct the AR8200 NOT to display frequencies while in memory read, search and scan modes (should you wish for prying eyes not to see specifically what you are listening to). Liberal use of ‘text comments’ is recommended if you disable frequency display (turned it off) unless you choose to have really anonymous operation!

Note: Frequency display will be provided in VFO and VFO search and VFO scan even with the frequency display disabled.

The FREQUENCY DISPLAY parameters are setup in the CONFIG menu. To access the config menu PUSH (F) PUSH (7GQ). PUSH ↓ eight times to move the cursor to the “FREQ DISP” selection point. Use the main dial or ⇐ ⇒ keys to toggle between ON and OFF. The (PASS) key may be used as a short cut to ON (which is default).

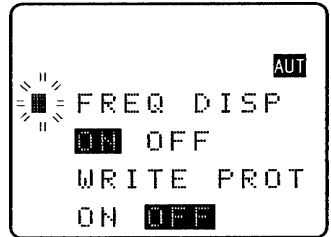

PUSH (ENT) to accept the data and return to a standard display. Alternatively PUSH (CLEAR) to abort entry or PUSH ↓ to move to the next item on the config menu (WRITE PROT).

14-8 CONFIG GLOBAL write protect

It is possible to globally write protect the entire AR8200 data storage, this prevents memory entry, search bank programming, loading of data via the option socket, loading of data from the optional EM8200 etc. **Use this feature carefully.**

Should you wish to leave your AR8200 safe in the knowledge that no-one will ‘mess it up’ (well maybe!)... toggle global write protect on.

The global “WRITE PROTECT” status is setup in the CONFIG menu. To access the config menu PUSH (F) PUSH (7GQ). PUSH ↓ nine times to move the cursor to the “WRITE PROT” selection point.

Use the main dial or \leftrightarrow keys or **(PASS)** key to toggle between ON and OFF (the default is off).

PUSH **(ENT)** to accept the data and return to a standard display. Alternatively **PUSH** **(CLEAR)** to abort entry or **PUSH** \downarrow to move to the next item on the config menu (OPENING MESSAGE).

14-9 CONFIG Opening message

It is possible to display a welcome message while the AR8200 is powering up and collating its 'boot-up' information. There are three options for opening message:

NORM

Normal message is displayed at switch-on: **WELCOME TO THE NEW WORLD OF AR8200.**

QUICK

Blank screen at switch-on.

USER

Four lines of 12 characters may be entered for display at switch-on. Initially they are configured for you to enter OWNERS name and PHONE NUMBER but all lines may be over-written.

The "**OPENING MESSAGE**" is setup in the CONFIG menu.

To access the config menu **PUSH** **(F)** **PUSH** **(7GQ)**.

PUSH \downarrow ten times to move the cursor to the

"**OPENING MESSAGE**" selection point. Use the main dial or \leftrightarrow keys to toggle between **NORM / QUICK / USER**.

The **(PASS)** key may be used as a short cut to NORM (which is the default).

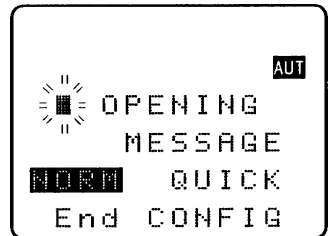

PUSH **(ENT)** to accept the data and return to a standard display

or **PUSH** **(CLEAR)** to abort entry.

Alternatively if you have selected **USER** and wish to change the text comment **PUSH** \downarrow to access the text input menu for the opening menu.

You may change all four lines of text in the usual manner. Please refer to **section 12-1** of this manual for further information regarding text input.

PUSH **(ENT)** to accept the data and return to

a standard display or **PUSH** **(CLEAR)** to abort entry. When the AR8200 is switched off and back on again, the new opening message will be displayed.

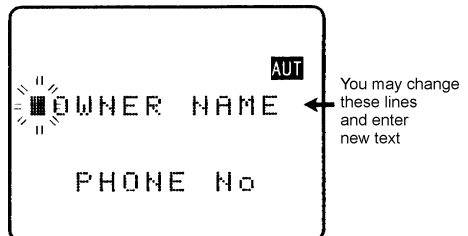

(15) Band scope

The AR8200 is equipped with a flexible band scope function which is capable of graphically displaying band activity. The maximum frequency span width is 10 MHz, you may zoom in on activity to a span width of 100 kHz. Centre frequency is displayed and a marker may be manipulated to ascertain the frequency of activity using the graphical display. One trace may be saved to memory for recall at a later time and may be overwritten at will. The trace may also be saved and loaded from the optional EM8200 external memory slot card.

 **Note:** Priority operation is **disabled** when the band scope is in operation. Audio is muted. The optional **RU8200** is **inoperative** when the band scope is in operation.

It is suggested that the band scope facility is 'experimented with' on a constantly active band such as VHF Band-II broadcast.

15-1 Starting the band scope

To start the band scope **PUSH**  **(SCOPE)**. The frequency span width will be set to 10 MHz with the last frequency displayed in 2VFO, search, scan or memory read mode being used as the centre frequency. **AUDIO IS MUTED.**

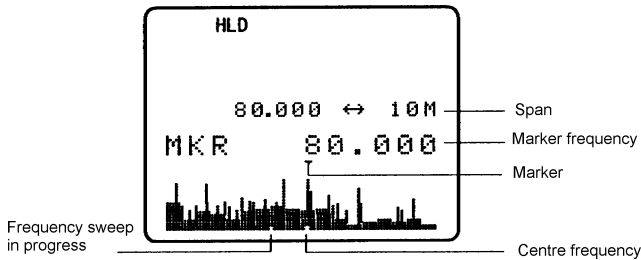





The **centre frequency** is displayed in the top left of the LCD, one pixel will be missing from the centre of the graphical base line indicating centre frequency position.

A progress **cursor** which comprises of a single pixel on the graphical base line travels from left to right updating the band scope display... this confirms that the band scope is **IN OPERATION** (especially useful when a trace is simply being updated or no signals have been located).

The **frequency span width** is displayed in the upper right corner of the LCD, at default this is 10 MHz.

The **frequency marker** legend "MKR" is displayed on the second line of the LCD, the marker is also represented graphically by an upturned triangle (initially placed above-centre of the graphical trace). When first activated, the centre and marker frequencies are the same (but may be altered).



The **graphical trace** is built-up from left to right. If no transmissions are encountered the display will simply form a horizontal line around two pixels in height. When activity is located, vertical lines are produced on the LCD, the stronger the signal the higher the line.

 **Important:** To **monitor** the transmission of the marker frequency **PRESS**  **and hold** the  **MONI** key. The progress of the scope is halted when the  **MONI** key is held. Squelch setting has no effect on the band scope trace.

15-2 Exit from band scope

To exit the band scope **PUSH**  **(SRCH)** or **(SCAN)** or **(2VFO)**.





15-3 Setting frequency span width (waveform enlargement)

The frequency span width may be adjusted between the limits of 10 MHz (default) to 100 kHz using the   keys. The span widths available are:







10 MHz	35s for full trace approx.	<i>Resolution is 10 kHz with a 12 kHz IF filter selected (NFM or AM) so that one pixel represents 140 kHz at maximum signal strength</i>
5 MHz	20s for full trace approx.	
2 MHz	10s for full trace approx.	
1 MHz	6s for full trace approx.	
500 kHz	3s for full trace approx.	
200 kHz	6s for full trace approx.	<i>Resolution is 2 kHz with a 3 kHz filter (USB, LSB, CW)</i>
100 kHz.	3s for full trace approx.	

When the frequency span width is altered, the trace restarts. **PUSH**  **(SCOPE)** to refresh the trace from the start.

15-4 Moving the marker

To move the marker position use the   keys, the channel step will be dependant upon the span width resolution. To monitor the marker frequency **PRESS**  **and hold** the  key. The progress of the scope is halted when the  key is held.

15-5 Marker to strongest signal (peak search)

To simplify operation, it is possible to 'jump the marker' to the strongest signal of the current graphical trace (peak search). **PRESS**  **and hold** the **(SCOPE)** key until the "★" legend is displayed indicating that the marker is set to the strongest graphical signal. **PRESS**  **and hold** the  key to monitor the selected frequency. The   keys may be used to hop between the strongest few transmissions. **PRESS**  **(SCOPE)** to disable peak search, the "★" will be removed from the LCD.

 **Note:** If no signal is found above the background level (or if there hasn't been time allowed for a trace to form), peak search will not operate and an error beep will be emitted (if beep is enabled). This facility cannot be used with a span width of 100 kHz.

15-6 Entering a new centre frequency



To enter a new centre frequency, simply tap the wanted frequency into the keypad. The legend "CENTRE FREQ" will be displayed on the top line of the LCD with entry taking place on the second line.

To complete entry in MHz format **PUSH**  **(ENT)**. The marker will be automatically set to the centre frequency but the frequency span width will be unchanged.



15-7 Transfer of marker frequency to VFO

There are two ways in which the marker frequency may be transferred to VFO for long term monitoring.

Transfer to 2VFO retaining VFO data



PUSH  **PUSH**  to move marker frequency to 2VFO, receive mode and step are those of the VFO.

Transfer to single VFO with 10 kHz tuning step

Hold the  **MONI** key then **PUSH**  to transfer marker frequency to single VFO, receive will be that used in VFO mode but the tuning step will always be 10 kHz to allow sensible re-tuning in VFO mode for best reception of the transferred marker frequency

15-8 Peak hold

The PEAK HOLD facility is used to build up an image of band activity over a period of time, the display is not totally cleared each time a trace is made, only strong signals are added.

To toggle PEAK HOLD on/off **PUSH**  **PUSH** , the "HLD" legend confirms when peak hold is active.

The $\leftarrow \rightarrow$ keys may be used to move the marker position and  **MONI** key may be held to monitor activity on the marker frequency.

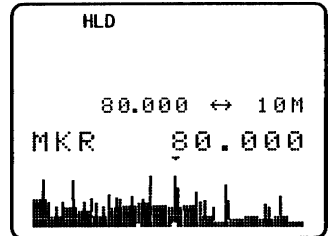



15-9 Saving active trace to memory

To save the current trace to internal memory (for later retrieval) **PRESS**  **(ENT)**. It is suggested that the peak hold facility be employed before saving a trace so that it provides more meaningful information.

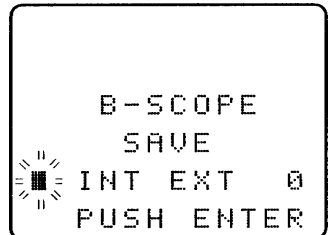
If the optional EM8200 is used, it possible to save four further traces to external memory. Refer to **section 18-6-7** of this manual for further information regarding this feature.



15-10 Loading stored band scope traces from memory

Providing a trace has been previously stored to memory, it is possible to recall it to display using the key sequence **PUSH**  **F** **PRESS**  **SCOPE**. The legend "RCV" (in the place of "MKR") indicates that a stored trace is currently being displayed.

The AR8200 will no longer sweep the frequency range but the  **MONI** key may still be used to monitor the marker frequency. Key in a new centre frequency to return to a real time band scope.

It is possible to move the marker across the graphical trace using the $\leftarrow \rightarrow$ keys. Waveform enlargement is available by changing the frequency sweep width using the $\uparrow \downarrow$ keys.

If the optional EM8200 is used, it possible to load any one of four further traces from external memory. Refer to **section 18-6-7** of this manual for further information regarding this feature.

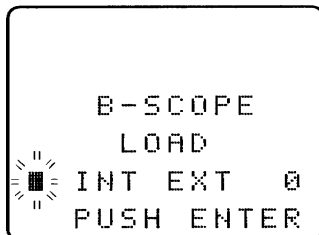

(16) Sleep ⌚

It is possible to instruct the AR8200 to automatically switch-off after a predetermined time, this is particularly useful if you know that you may be called away from the receiver or listen to it while in bed and don't want the batteries to become completely flat.

Use the key sequence **PUSH** **(F)** **PRESS** **(● Aa)** to access the SLEEP menu.

Use the main dial, $\leftarrow \rightarrow$ keys or **(PASS)** key to toggle sleep on/off. For convenience SLEEP is default ON when this menu is accessed so that you have simply to access and exit the menu for sleep to be activated.

Either **PUSH** **(ENT)** to save the changes and exit the menu or **PUSH** \downarrow to move the cursor to the sleep TIME menu. Use the main dial to set sleep time in 1s increments or $\leftarrow \rightarrow$ keys to increment in 10 seconds, the range is between 1 and 120 minutes, **(PASS)** is a short cut to 60 minutes (default).

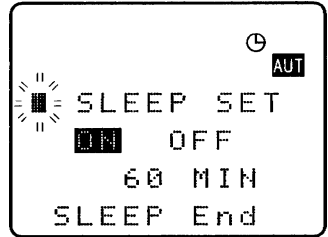

The AR8200 will automatically switch off after the programmed time has elapsed.

To accept the data and activate sleep **PUSH** **(ENT)**. The display will return to standard format and the circular CLOCK legend ⌚ will be displayed to remind you that automatic power off will take place.

The next time that the AR8200 is powered on, the sleep facility will be automatically cancelled.

(17) Option socket

The option socket is mounted on the right hand side of the cabinet underneath the 12V d.c. input socket. The socket is protected from dust by a grey rubberised case stopper which is hinged toward the front of the cabinet. Gently lift the stopper from the rear edge to reveal the D-shaped metallic socket. Be careful to keep dust and dirt from this socket and to prevent liquid entering the AR8200 via this socket. Ensure that no conductive material is allowed to short circuit the socket which may damage the receiver.

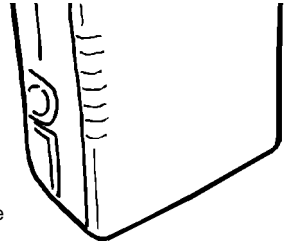

The option socket has three main uses:

1. Connection of the optional CR8200 tape recording lead
2. Connection of the optional CO8200 data clone lead
3. Connection of the optional CC8200 computer control lead with level shift (available with imperial (PC98) & metric (DOSV) screws)

Other signals are available via the option socket including detector output, mute and AGC. Typical pin-out of the optional leads are as follows:

RED	+4.2V
BLACK	RXD
BLUE	GROUND
BROWN	MUTE
ORANGE	AGC
SHIELD	GROUND
WHITE	TXD
YELLOW	GROUND
GREEN	AUDIO OUT
GREY	DETECTOR OUT
PURPLE	GROUND

Output levels are as follows:

MUTE	CMOS (0V or 5V)
AUDIO OUT	Constant level into greater than 10k OHMS
DETECTOR OUT	Available in NFM & SFM, impedance 10k OHMS
AGC	3.5V to 0.5V, impedance 10k OHMS
RS232C	TXD + RXD (levels to drive a level shift converter)  Note: The voltage output level to drive external RS232 is deliberately below 'H' level. If connecting to an external I.C., you must be aware of latch status.
PSU	4.2V at 20mA

17-1 RS232 operation

Connect the optional CC8200 computer control lead to the option socket and connect to a computer. The command protocol is provided with the CC8200 on floppy disk as an Adobe Acrobat PDF file.

The RS232 parameters may be defined using the CONFIG menu. Baud rates (transfer speed) may be set to 4800, 9600 or 19200bps. It is also possible to set an 'address' to facilitate connection of up to 99 AR8200 to a single port for custom operation, the addresses may be set between the limits of 01 to 99 with 00 representing single radio operation.

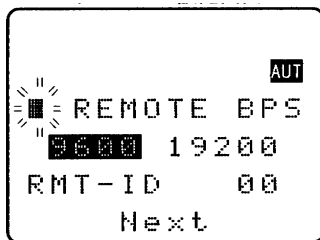

When operating from external RS232, the legend  will be displayed on the LCD. Please refer to **section 14-6** of this manual for information on the CONFIG menu settings.

17-2 CLONE of data via the option socket

It is possible to copy data (clone) between two AR8200 receives using the optional CO8200 clone lead, no computer is required.

 **Note:** As clone of data takes a while, it is suggested that the receivers are connected to external power or at least that the NiCads are FULLY charged while cloning data. Do not prematurely terminate the clone of data in any way or data corruption may occur... do not switch either AR8200 off, disconnect the CO8200 or disconnect power. Data can be copied in either direction but the EM8200 is not supported, only INTERNAL data can be copied between radios.

Connect each radio to the CO8200 lead and switch them on. The following table indicates the facilities available:

ALL DATA	All data is transferred from one radio to the other (approx. 8 minutes 30 seconds)
SEARCH BANK	A specific search bank is copied to the same or different bank number of the second radio (approx. 3 seconds)
ALL SEARCH	All search banks are copied from one radio to the other keeping bank numbers the same (approx. 1 minute 30 seconds)
MEM BANK	A specific memory bank is copied to the same or different bank number of the second radio. Ensure that the memory banks have the same sizes allocated (dynamic memory bank resizing) or data may be lost (approx. 30 seconds)
ALL MEM	All memory banks are copied from one radio to the other keeping bank numbers the same. Memory banks are handled as a 'pair' (A/a, B/b etc). If memory banks are not the same size (dynamic memory bank resizing), some data will be lost. (approx. 5 minutes)

17-2-1 How to clone data

Ensure that the RS232 baud rate is set to the same speed for both radios and that the address is set to 00 on both units (refer to **section 14-6** of this manual for information on the CONFIG menu settings).

a) Pick the radio which you wish to copy TO (target)

First decide which unit will be used to receive (LOAD) the data.

PUSH (F) PRESS (O JT) to access the "COPY RS232C" menu. The (PASS) key acts as a toggle between "LOAD" and "SAVE" (the default is LOAD), alternatively use the main dial or ⇐ ⇒ keys to select LOAD.



b) Decide WHAT you want to copy

PUSH the ↓ key to move down the COPY RS232C menu, the cursor will be flashing to the left of the item "ALL-DATA". If you want to load ALL DATA PUSH (ENT), alternatively use the main dial or ⇐ ⇒ keys to select the type of data you wish to load (copy) from the other radio. PUSH (ENT).

The bottom two rows of the LCD will display the legends "LOADING !!" and a number. The number will start counting downward when the copy process starts (when the other radio has been instructed to SAVE), the more data you have selected, the higher the number... for ALL-DATA the number will typically be 448.

Data CLONE
of search or
memory banks
between
2 x AR8200

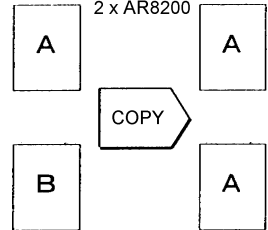

c) Configure the radio used to SAVE

On the second radio, PUSH (F) PRESS (O JT) to access the "COPY RS232C" menu.

The (PASS) key acts as a toggle between "LOAD" and "SAVE" (the default is LOAD), alternatively use the main dial or ⇐ ⇒ keys to select SAVE.

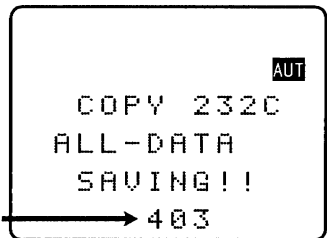

PUSH the ↓ key to move down the COPY RS232C menu, the cursor will be flashing to the left of the item "ALL-DATA". If you want to load ALL DATA PUSH (ENT), alternatively use the main dial or ⇐ ⇒ keys to select the type of data you wish to save (send) to the other radio. **It is most important that the type of data selected is IDENTICAL on both radios.** PUSH (ENT).

Complete when
this number
reaches 0 (zero)



The bottom two rows of the LCD will display the legends "SAVING !!" and a number which will start counting downward to indicate that the copy process (clone of data) has started. When the number reaches **zero** the copy process will have completed, both radios will revert to standard displays.



Note: If you make a mistake during programming, it is possible to PUSH  the  key to exit the menu. However, be careful and get it right in the first place... this is the best way of avoiding the possibility of data corruption.

Write protect

Individual memory channel protect and search bank protect status is ignored, however global protect will prevent data being cloned between radios.

(18) Slot card socket

The slot card is located in the bottom of the AR8200 cabinet and protected from dust etc by a door which is hinged toward the back edge of the cabinet. To access the socket place the AR8200 on its back and open the front edge of the protective door. Be careful to keep dust and dirt from this socket and to prevent liquid entering the AR8200 via this socket. Ensure that no conductive material is allowed to short circuit the socket which may damage the receiver.

18-1 Optional slot cards

Any 'one' optional card may be fitted at any time. Do not use anything other than the 'genuine' AOR slot cards.

The slot card has five main uses:

1.	VI8200	Voice inverter (analogue) in 157 steps
2.	CT8200	CTCSS squelch & search
3.	TE8200	Tone eliminator in 256 steps
4.	RU8200	Chip based recording and playback, 20 seconds approx.
5.	EM8200	External extended memory, backup 4,000 memories, 160 search banks (can hold as much data as 4 x AR8200)

Signal types depend upon the slot card fitted, these include:

- 4.2V PSU
- GROUND
- CARD RECOGNITION
- AUDIO IN
- AUDIO OUT
- CARD CONTROL IN
- CARD CONTROL OUT

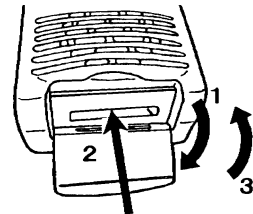

18-1-1 Fitting the slot card

Always switch the AR8200 off when inserting slot card. To access the socket place the AR8200 on its back and open the front edge of the protective door. With the AR8200 keypad facing upward, hold the slot card so that its label also faces upward. An arrow printed on the slot card indicates the direction of entry into the AR8200, insert the connector end of the slot card into the AR8200 (the end you will be left holding has grooves to help grip). Without using excessive force, use a thumb to push the slot card fully into the body of the AR8200 until it is slightly recessed into the bottom of the receiver. Close the hinged slot card compartment cover.



Insert the card as illustrated

 **Note:** The AR8200 will automatically recognise each optional slot card, there is no need to initialise the option (except for the EM8200, see later).

When slot cards are fitted, the AR8200 menu system dynamically changes to reflect the slot card currently fitted. If however the AR8200 'thinks' that a slot card option is fitted when it isn't, access the slot card menu and disable the option.

You may wish to leave certain items selected if they are not affecting current operation in order to minimise reprogramming when slot cards are inter-changed at a later time.

18-1-2 Removing the slot card

Always switch the AR8200 off when removing a slot card. To access the socket place the AR8200 on its back and open the front edge of the protective door. An EJECT slider is mounted on the left hand side of the AR8200 cabinet. With the AR8200 keypad facing upward slide the EJECT control toward the side keys of the AR8200, the thumb is best for this purpose... hold the thumb of the other hand one or two centimetres (one inch) from the bottom of the slot card to prevent it shooting out of the AR8200 and falling on the floor.

The stiffness of the cards varies and may be tighter when used for the first few times, the EJECT slider needs quite a push but don't use excessive force or tools!

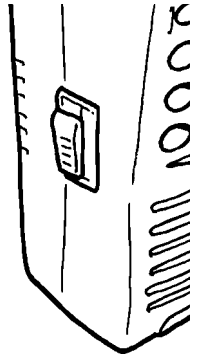

18-2 VI8200 optional voice inverter slot card

The VI8200 enables the AR8200 to recover intelligible audio from certain types of analogue transmission which would otherwise sound scrambled. They operate by splitting up the audio spectrum and 'flipping' the upper and lower tones around a certain frequency point. The VI8200 enables 157 different 'flip points' to be selected in the frequency range of 2.4 kHz to 5.6 kHz.

Insert the VI8200 slot card and switch the AR8200 on, select VFO mode.

PRESS (CLEAR) to access the slot card option menu. The AR8200 will have recognised that the VI8200 has been fitted so will present the voice inverter menu.

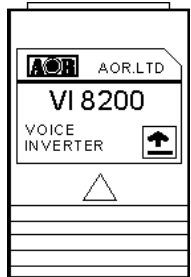

The legend "VOICE INVERT" confirms selection of the voice inverter menu.

PUSH the (PASS) key to toggle the voice inverter on/off (default on). Use the main dial or \uparrow \downarrow keys to make selection of tone in 157 steps from 0 to 156, the \leftarrow \rightarrow keys are used to increment selection by 10.

To accept the data input (when audio is intelligible) PUSH (ENT), alternatively to abort entry

PUSH (CLEAR).

Refer to the relationship table between value and 'flip' frequency:

Frequency (kHz)	2.4	2.8	3.2	3.6	4.0	4.4	4.8	5.2	5.6	6.0	6.15
Inverter value	0	37	64	86	102	116	128	138	146	154	156

When the voice inverter has been activated and you exit from the voice inverter menu back to VFO, the legend "v 68" will be displayed in the bottom right corner of the LCD. The legend "v" indicates that the inverter is active while the legend "68" indicates the current 'flip' value in use.

To speed up the toggling of voice inverter, PRESS  (CLEAR) to effectively toggle the voice inverter option on/off. This is achieved as the default is set to voice inverter ON (by accessing the voice inverter menu) so that every time the voice inverter menu is accessed, the voice inverter is automatically activated.

1. For example, assume that the voice inverter is currently OFF. PRESS  (CLEAR) to access the voice inverter menu, the voice inverter menu cursor will move to "ON".

2. PUSH  (CLEAR) to revert to VFO mode with the voice inverter on.

3. PRESS  (CLEAR) to immediately toggle the voice inverter off.

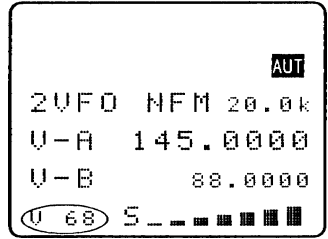

The sequence then repeats each time you PRESS  (CLEAR).

 **Note:** Using the voice inverter to monitor normal transmissions will cause them to distort and sounds rather like tuning across a busy short wave band using USB.



18-3 CT8200 optional CTCSS slot card

The CT8200 enables the AR8200 to search for 50 CTCSS tones which may be in use on the current receive frequency and to save a specific CTCSS tone (from the 50 tones available) into each VFO, each search bank and every memory channel individually. CTCSS is used by many amateur band repeaters, public utilities and private mobile radio services where shared resources are used, CTCSS ensures that operators only hear traffic intended for them.

Insert the CT8200 slot card and switch the AR8200 on, select VFO mode.

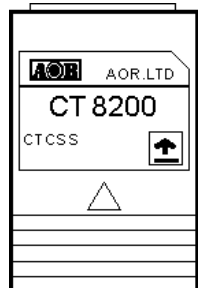
PRESS  (CLEAR) to access the slot card option menu. The AR8200 will have recognised that the CT8200 has been fitted so will present the CTCSS menu.



The legend "CTCSS" confirms selection of the CTCSS menu. PUSH  the (PASS) key or use the \uparrow \downarrow keys to toggle the CTCSS facility between OFF / ON / SRCH (default is off). To abort entry and exit the menu PUSH  (CLEAR).

 **Note:** You won't be able to audibly hear a CTCSS tone due to the low frequencies employed and audio characteristics of the AR8200 (and other receivers).

18-3-1 CTCSS tone squelch

While in the CTCSS menu, PUSH  (PASS) to activate the CTCSS facility (the LCD legend "ON" is displayed in reverse highlight).

Use the main dial or \leftrightarrow keys to make selection of CTCSS tone from the 50 available, the value cannot be adjusted when the menu is set to "OFF". The current CTCSS tone is displayed on the last-but-one line of the LCD, the legend "★" is displayed to the left of the CTCSS frequency when the current receive frequency is using the displayed CTCSS tone, this assists manual selection of the correct tone.

To accept the data input **PUSH** **(ENT)** alternatively to abort entry **PUSH** **(CLEAR)**. The selected CTCSS tone may be used in VFO (separate CTCSS tones may be held in each VFO) and independent CTCSS tones saved in each search bank and memory channel.

While in VFO, the legend "CTC" is displayed in the lower left corner of the LCD to indicate that CTCSS is active. The audio will be completely muted until a transmission occurs which contains the specified CTCSS tone even when the squelch is set fully anti-clockwise (open), it is normal for the occasional 'splutter' to be produced as 'CTCSS type fingerprints' naturally occur in everyday transmissions and background noise.

Scan & search banks: It is even possible to scan & search with the squelch open when CTCSS is active but scan/search rates will be reduced significantly. To achieve the best speeds, set the squelch until the "S" legend is extinguished in the usual manner.

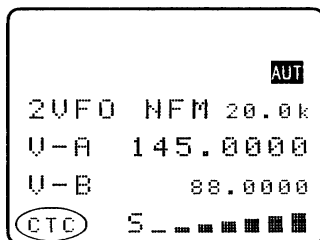

Refer to the CTCSS table of available tones:

94.8	100.0	103.5	107.2	110.9
114.8	118.8	123.0	127.3	131.8
136.5	141.3	146.2	151.4	156.7
162.2	167.9	173.8	179.9	186.2
192.8	203.5	210.7	218.1	225.7
233.6	241.8	250.3	67.0	71.9
74.7	77.0	79.7	82.5	85.4
88.5	91.5	97.4	69.4	159.8
165.5	171.3	177.3	183.5	189.9
196.6	199.5	206.5	229.1	254.1

To switch CTCSS off, access the CTCSS menu **PRESS** **(CLEAR)** **PUSH** **(PASS)** to highlight the legend "OFF" then **PUSH** **(ENT)**.

18-3-2 CTCSS search

If you are uncertain what CTCSS frequency is in use, but you think there may be one present, you may use the CTCSS SEARCH facility to discover what frequency is employed.

Place the AR8200 into VFO mode then **PRESS** **(CLEAR)** to access the CTCSS menu.

PUSH **(PASS)** to highlight the "SRCH" legend then **PUSH** **(ENT)** to accept the input and exit the menu.

The LCD legend "**CT-S**" will be displayed in the bottom left corner of the LCD to indicate that CTCSS SEARCH is in operation. While in 2VFO mode, the standby frequency will be replaced with the legend "**CTCSS 205.5 Hz**" when a CTCSS tone of 205.5 Hz has been located, otherwise the appropriate CTCSS frequency will be displayed.

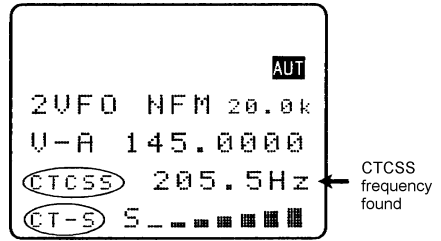

Each memory channel, VFO and search bank can hold different CTCSS frequencies and different settings of CTCSS squelch and CTCSS search (i.e. you can have CTCSS search active in VFO but CTCSS squelch active in memory channels).

If you are uncertain where CTCSS may occur and wish to experiment with CTCSS search, simply activate the CTCSS SEARCH facility while monitoring a broadcast frequency (such as Band-II) which has a rich audio range (playing music etc).

 **Note:** As CTCSS search has to check all 50 possible frequencies, it may take up to 15 seconds for the CTCSS tone to be identified.

18-4 TE8200 optional tone eliminator slot card

The TE8200 enables the AR8200 to ignore certain transmission tones which would otherwise stop the scan and search processes. Pilot tones are often transmitted by public utility services and railways making their transmissions troublesome and fatiguing to monitor without the use of the TE8200. There are 256 values for the tone eliminator ranging from 0 to 255 representing a frequency range of 0.4 kHz to 4.2 kHz.

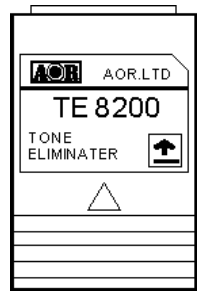

Insert the TE8200 slot card and switch the AR8200 on, select VFO mode.

PRESS  **CLEAR** to access the slot card option menu. The AR8200 will have recognised that the TE8200 has been fitted so will present the tone eliminator menu.



The legend "**TONE ELMT**" confirms selection of the tone eliminator menu. PUSH  the **PASS** key to toggle the tone eliminator on/off (default off). Use the main dial or \uparrow \downarrow keys to make selection of tone in 256 steps from 0 to 255, the \leftarrow \rightarrow keys are used to increment selection of tone in increments of 10.

When selecting the value, the legend "**★**" will be displayed to the left of the numeric value to indicate that the displayed tone value is contained in the current receive frequency, this greatly eases location of the offending tone frequency to allow scan and search to continue.

To accept the data input PUSH  **ENT**, alternatively to abort entry PUSH  **CLEAR**. When active, the LCD legend "**T.EL**" will be displayed in the bottom left corner of the LCD.

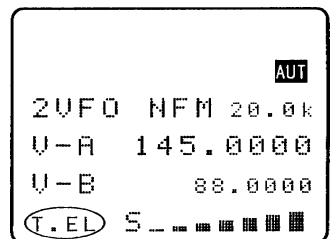

Refer to the table to reconcile value with frequency:

Frequency (kHz)	0.4	0.6	1.0	1.4	1.8	2.2	2.6	3.0	3.4	3.8	4.2
Tone value	0	70	160	190	210	220	230	237	240	245	248
	-	-	-	-	-	-	-	-	-	-	-
	60	110	170	200	220	230	235	240	245	248	250

Tone eliminator setting and value may be held separately in each VFO, search bank and memory channel.

The squelch should be set to threshold in the usual manner. Operation continues as normal with the tone eliminator active, however if a transmission is encountered which contains a 'pilot tone' which matches the current setting of the tone eliminator, the squelch will close allowing the scan and search processes to continue... i.e. the AR8200 will NOT think that it has found an active receive frequency or blank carrier.

 **Note:** The tone eliminator **does not** remove whistles from the loudspeaker, it purely allows scan & squelch to continue unhindered.

18-5 RU8200 optional record & playback slot card



The RU8200 enables around 20 seconds of audio to be recorded to a chip within the RU8200 for playback at a later time. The chip may be recorded to time and time again overwriting the previous recordings. The recording may be played back over and over, very useful if you have grabbed an interesting recording! The RU8200 may be used in VFO, scan, search and memory read modes.



Insert the RU8200 slot card and switch the AR8200 on, select VFO mode.

PRESS  (CLEAR) to access the slot card option menu. The AR8200 will have recognised that the RU8200 has been fitted so will present the record / playback menu.

The legend "RECORDER" confirms selection of the record & playback menu. PUSH  the (PASS) key or use the main dial or ⇄ ⇨ ⇩ ⇪ keys to toggle between "REC" and "PLAY" representing record and playback.

PUSH  (ENT) to accept the selection and return to the previous menu or PUSH  (CLEAR) to abort.

Recording and playback can be carried out while the AR8200 is in VFO, scan or search mode.

18-5-1 Recording

While in the record & playback menu select "REC" and PUSH  (ENT). The LCD will return to its previous display with the legend "REC" in the bottom left corner of the LCD to show that the RU8200 is active. If the squelch is currently open, recording will take place immediately, otherwise recording will take place next time the squelch opens.

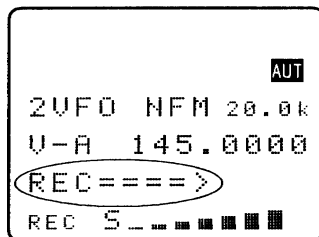

While recording is in progress, the second line from the bottom of the LCD (usually displaying the standby frequency in 2VFO mode) changes to a progress bar "REC =====>" indicating that recording is in progress. Once started, the recording process continues for about 20 seconds and the legend "End" is displayed when the recording process is complete. Once started recording continues even if the squelch closes but you may PUSH the (CLEAR) key half way through a recording to stop it from recording 20 seconds of nothing! PUSH the (CLEAR) key after recording has ended to clear the recording related text from the LCD.

 **Note:** RU8200 recording is disabled when the band scope facility is operational.

18-5-2 Playback

It is assumed that you have already made a recording. While in the record & playback menu select "PLAY" and PUSH the (ENT) key. The LCD will return to its previous display with the legend "PLY" in the bottom left corner of the LCD to show that the RU8200 is active. Playback will start instantly.

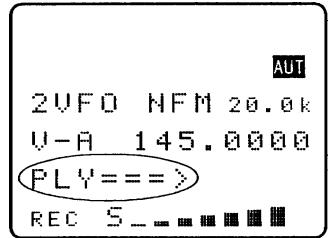

While playback is in progress, the second line from the bottom of the LCD (usually displaying the standby frequency in 2VFO mode) changes to a progress bar "PLY =====>" indicating that playback is in progress. Once started, the playback process continues for about 20 seconds and the legend "End" is displayed when the playback is complete.

You may PUSH the (CLEAR) key to cancel playback or clear the recording related text from the LCD.

 **Note:** No liability in any form will be accepted in respect of recordings made using the RU8200 option.



18-6 EM8200 optional external extended memory slot card

The EM8200 enables the whole 1,000 memory channels in 20 banks and 40 program search banks to be backed up to the EM8200. In fact the EM8200 can hold the entire contents of the AR8200 including environmental operating data and band scope FOUR times in EM8200 locations 0, 1, 2 & 3. It is not necessary to save ALL data, you can specifically choose what data is to be backed up and to which location.

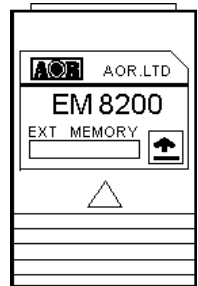
 **Note:** You cannot scan or search the backup information, data must be loaded back into the AR8200 before these processes can be activated.



 **Important note:** Never remove the EM8200 with the AR8200 switched on, especially while data is being saved / loaded to and from the AR8200 or data corruption may occur. Saving all data takes some time, it is recommended that external power be used while copying large volumes of data to / from the EM8200 (or at least be sure that the batteries are well charged). No liability in any form will be accepted in respect of data saved to / loaded from the EM8200 option.

 **Note regarding write protect:** If the write protect has been **globally** set to ON (ALL PROTECT) in the configuration menu (PUSH  F PUSH  7 GQ), data load will be unsuccessful and no data will be loaded. Individual memory channel protect, memory bank protect and search bank protect will be ignored during data load from the EM8200.

 **Note regarding possible NOISE:** A small increase in 'noise' may be noticed while the EM8200 option is fitted inside the AR8200, this will disappear when the EM8200 is removed from the receiver. If signals are very weak or noise is a problem, temporarily remove the EM8200 option.

The following table indicates the data types which may be saved to / loaded from the EM8200:



1	ALL-DATA	All memories, search banks, band scope and environment data
2	ALL-MEM	All memory channels
3	MEM-BANK	One specified memory bank
4	ALL-SRCH	All search banks
5	SRCH-BANK	One specified search bank
6	B-SCOPE	Band scope data

18-6-1 Initialising (formatting) the EM8200 before use

The EM8200 has been tested during manufacture but is not fully formatted. Before you use the EM8200 for saving real data, you must format the memory, this only needs to be carried out once in the life of the EM8200 (similar to formatting a computer disk drive).

To format the memory, simply execute a SAVE ALL to each of the four memory locations of the EM8200 (0, 1, 2 & 3).

If you do not format the memory, you will still be able to carry out SAVE ALL (item 1 in the table) but the specific data saves (items 2, 3, 4, 5 & 6 will not operate). If you do not format the memory and later attempt to use a specific memory save or load, an error beep will sound (if beep is enabled).

To access the COPY EXT-MEM menu (which is used for the EM8200 data save / load and has been selected dynamically in place of the COPY RS232C menu as the AR8200 recognises that the EM8200 is fitted) PUSH  F PRESS  0 JT. Four significant lines of menu are displayed:

1	COPY EXT-MEM	Indicates that the EM8200 COPY menu has been accessed
2	LOAD SAVE 0	Select save to or load from the EM8200 and EM8200 bank number (0, 1, 2 & 3)
3	ALL-DATA	Type of data to be saved / loaded
4	Next	Access to further menu items

First select the "SAVE" option, PUSH  PASS to toggle between load and save.

Next select the EM8200 bank you wish to save, the first time select "0" using the ⇐ ⇨ keys (later you will need to select 1, 2 & 3 to fully format the EM8200).

The type of data will already be default to "ALL-DATA" so no action is required.

PUSH  (ENT) to start the data save. The legend "EXT-MEM SAVING !!" will be displayed with the exclamation marks flashing to indicate that saving is in progress. The save process will take over 20 seconds to complete. Once the save is complete, the LCD will revert to its previous display (VFO, scan or search etc).

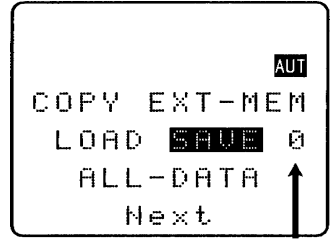

EM8200 external bank (BLOCK) number

Now repeat the ALL-DATA save to EM8200 locations 1, 2 and 3 to complete the formatting process.

18-6-2 EM8200 ALL-DATA save and load

Before loading data from the EM8200 it is recommended that ALL DATA save be used to make a copy of the AR8200 into one of the EM8200 memory locations (i.e. keep one as a temporary copy of your current AR8200 data).

Save ALL-DATA

Access the COPY EXT-MEM menu using the key sequence

PUSH  (F) PRESS  (OJT)

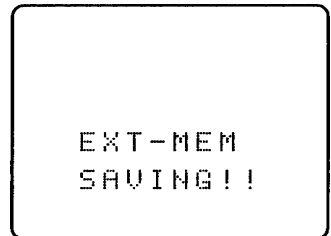

Select the "SAVE" option, PUSH  (PASS) to toggle between load and save. Next select the EM8200 bank you wish to save using the ⇄ ⇄ keys (0, 1, 2 or 3). The type of data will already be default to "ALL-DATA" so no action is required.





PUSH  (ENT) to start the data save. The legend "EXT-MEM SAVING !!" will be displayed with the exclamation marks flashing to indicate that saving is in progress. The save process will take over 20 seconds to complete. Once the save is complete, the LCD will revert to its previous display (VFO, scan or search etc).

Load ALL-DATA

It is presumed that you have already saved ALL DATA to one of the four EM8200 memory locations. Make sure that global write protect is not set or the data load will be unsuccessful and no data will be loaded.

Access the COPY EXT-MEM menu using the key sequence PUSH  (F) PRESS  (OJT)

Select the "LOAD" option, PUSH  (PASS) to toggle between load and save. Next select the EM8200 bank you wish to load using the ⇄ ⇄ keys (0, 1, 2 or 3). The type of data will already be default to "ALL-DATA" so no action is required.



PUSH  (ENT) to start the data load. The legend "EXT-MEM LOADING !!" will be displayed with the exclamation marks flashing to indicate that loading is in progress.



The load process will take over 20 seconds to complete. Once the load is complete, the AR8200 will power off/on and the LCD will revert to its previous display (VFO, scan or search etc).

18-6-3 EM8200 ALL-MEM save and load

It is not necessary to save and load all of the data at times when you do not wish your search banks etc over-written. Instead use ALL-MEM to overwrite all memory banks in one go but to leave the search banks etc unchanged.

Save ALL-MEM (all memory banks)



Access the COPY EXT-MEM menu using the key sequence **PUSH**  **(F)** **PRESS**  **(O JT)**.



Select the **"SAVE"** option, **PUSH**  **(PASS)** to toggle between load and save. Next select the EM8200 bank you wish to save using the \leftrightarrow keys (0, 1, 2 or 3). **PUSH**  the \downarrow key to move the cursor to the left of the **"ALL-DATA"** legend, use the \leftrightarrow keys to select **"ALL-MEM"**.

PUSH  **(ENT)** to start the memory data save. The legend **"EXT-MEM SAVING !!"** will be displayed with the exclamation marks flashing to indicate that saving is in progress. The memory save process will take over 10 seconds to complete. Once the save is complete, the LCD will revert to its previous display (VFO, scan or search etc).

Load ALL-MEM (all memory banks)

It is presumed that you have already saved memory data to one of the four EM8200 memory locations. Make sure that global write protect is not set or the data load will be unsuccessful and no data will be loaded.

Access the COPY EXT-MEM menu using the key sequence **PUSH**  **(F)** **PRESS**  **(O JT)**.



Select the **"LOAD"** option, **PUSH**  **(PASS)** to toggle between load and save. Next select the EM8200 bank you wish to load using the \leftrightarrow keys (0, 1, 2 or 3). **PUSH**  the \downarrow key to move the cursor to the left of the **"ALL-DATA"** legend, use the \leftrightarrow keys to select **"ALL-MEM"**.



PUSH  **(ENT)** to start the data load. The legend **"EXT-MEM LOADING !!"** will be displayed with the exclamation marks flashing to indicate that loading is in progress. The memory load process will take over 20 seconds to complete. Once the load is complete, the LCD will revert to its previous display (VFO, scan or search etc).

18-6-4 EM8200 MEMORY BANK save and load

The memory data 'saved or loaded' can be specific to one bank only. Memory banks must be saved and loaded as a pair i.e. A/a, B/b, C/c etc.

Save MEM-BANK (one specific memory bank)



Access the COPY EXT-MEM menu using the key sequence **PUSH**  **(F)** **PRESS**  **(0 JT)**.



Select the "**SAVE**" option, **PUSH**  **(PASS)** to toggle between load and save. Next select the EM8200 bank you wish to save using the ⇄ keys (0, 1, 2 or 3). **PUSH**  the ↓ key to move the cursor to the left of the "**ALL-DATA**" legend, use the ⇄ keys to select "**MEM-BNK**". **PUSH**  the ↓ key to move the cursor to the right of the legend "**MEM-BNK**" to enable selection of the desired memory bank to save. Use the main dial, ⇄ keys or keypad to select the desired memory bank.

PUSH  **(ENT)** to start the memory data save. The legend "**EXT-MEM SAVING !!**" will be displayed with the exclamation marks flashing to indicate that saving is in progress. The memory save process will take a couple of seconds to complete. Once the save is complete, the LCD will revert to its previous display (VFO, scan or search etc).

Load MEM DATA (all memory banks)

It is presumed that you have already saved memory data to one of the four EM8200 memory locations. Make sure that global write protect is not set or the data load will be unsuccessful and no data will be loaded.

Access the COPY EXT-MEM menu using the key sequence **PUSH**  **(F)** **PRESS**  **(0 JT)**.



Select the "**LOAD**" option, **PUSH**  **(PASS)** to toggle between load and save. Next select the EM8200 bank you wish to save using the ⇄ keys (0, 1, 2 or 3). **PUSH**  the ↓ key to move the cursor to the left of the "**ALL-DATA**" legend, use the ⇄ keys to select "**MEM-BNK**". **PUSH**  the ↓ key to move the cursor to the right of the legend "**MEM-BNK**" to enable selection of the desired memory bank to load. Use the main dial, ⇄ keys or keypad to select the desired memory bank.



PUSH  **(ENT)** to start the memory data load. The legend "**EXT-MEM LOADING !!**" will be displayed with the exclamation marks flashing to indicate that loading is in progress. The memory load process will take a couple of seconds to complete. Once the load is complete, the LCD will revert to its previous display (VFO, scan or search etc).

18-6-5 EM8200 ALL-SRCH save and load

It is not necessary to save and load all of the data at times when you do not wish your memory banks etc over-written. Instead use ALL-SRCH to overwrite all search banks in one go but to leave the memory banks etc unchanged.

Save ALL-SRCH (all search banks)



Access the COPY EXT-MEM menu using the key sequence **PUSH**  **(F)** **PRESS**  **(O JT)**.



Select the “**SAVE**” option, **PUSH**  **(PASS)** to toggle between load and save. Next select the EM8200 bank you wish to save using the ⇄ keys (0, 1, 2 or 3). **PUSH**  the ↓ key to move the cursor to the left of the “**ALL-DATA**” legend, use the ⇄ keys to select “**ALL-SRCH**”.

PUSH  **(ENT)** to start the search data save. The legend “**EXT-MEM SAVING !!**” will be displayed with the exclamation marks flashing to indicate that saving is in progress. The search save process will take a few seconds to complete. Once the save is complete, the LCD will revert to its previous display (VFO, scan or search etc).

Load ALL-SRCH (all search banks)

It is presumed that you already have search data in one of the four EM8200 memory locations. Make sure that global write protect is not set or the data load will be unsuccessful and no data will be loaded.

Access the COPY EXT-MEM menu using the key sequence **PUSH**  **(F)** **PRESS**  **(O JT)**.



Select the “**LOAD**” option, **PUSH**  **(PASS)** to toggle between load and save. Next select the EM8200 bank you wish to load using the ⇄ keys (0, 1, 2 or 3). **PUSH**  the ↓ key to move the cursor to the left of the “**ALL-DATA**” legend, use the ⇄ keys to select “**ALL-SRCH**”.



PUSH  **(ENT)** to start the data load. The legend “**EXT-MEM LOADING !!**” will be displayed with the exclamation marks flashing to indicate that loading is in progress. The search load process will take a few seconds to complete. Once the load is complete, the LCD will revert to its previous display (VFO, scan or search etc).

18-6-6 EM8200 SEARCH BANK save and load

The search data ‘saved or loaded’ can be specific to one bank only.

Save SRCH-BANK (one specific search bank)

Access the COPY EXT-MEM menu using the key sequence **PUSH**  **(F)** **PRESS**  **(O JT)**.



Select the “**SAVE**” option, **PUSH**  **(PASS)** to toggle between load and save. Next select the EM8200 bank you wish to save using the ⇄ keys (0, 1, 2 or 3). **PUSH**  the ↓ key to move the cursor to the left of the “**ALL-DATA**” legend, use the ⇄ keys to select “**SRCH -BANK**”.



PUSH  the \downarrow key to move the cursor to the right of the legend "SRCH-BANK" to enable selection of the desired search bank to save. Use the main dial, $\leftarrow \rightarrow$ keys or keypad to select the desired search bank.

PUSH  (ENT) to start the search data save. The legend "EXT-MEM SAVING !!" will be displayed with the exclamation marks flashing to indicate that saving is in progress. The search save process will take a couple of seconds to complete. Once the save is complete, the LCD will revert to its previous display (VFO, scan or search etc).

Load SRCH-BANK (one specific search bank)

It is presumed that you have already saved search data to one of the four EM8200 memory locations. Make sure that global write protect is not set or the data load will be unsuccessful and no data will be loaded.

Access the COPY EXT-MEM menu using the key sequence PUSH  (F) PRESS  (O JT).



Select the "LOAD" option, PUSH  (PASS) to toggle between load and save. Next select the EM8200 bank you wish to load using the $\leftarrow \rightarrow$ keys (0, 1, 2 or 3). PUSH  the \downarrow key to move the cursor to the left of the "ALL-DATA" legend, use the $\leftarrow \rightarrow$ keys to select "SRCH-BANK". PUSH  the \downarrow key to move the cursor to the right of the legend "SRCH-BANK" to enable selection of the desired search bank to load. Use the main dial, $\leftarrow \rightarrow$ keys or keypad to select the desired search bank.

PUSH  (ENT) to start the search data load. The legend "EXT-MEM LOADING !!" will be displayed with the exclamation marks flashing to indicate that loading is in progress. The search load process will take a couple of seconds to complete. Once the load is complete, the LCD will revert to its previous display (VFO, scan or search etc).

18-6-7 EM8200 internally stored band scope save and load

It is possible to save the internally stored band scope to the EM8200 external memory locations 0, 1, 2, 3 or 4 using the "COPY EXT-MEM" menu. If a band scope trace is currently 'actively' displayed on the LCD while in BAND SCOPE mode, it may also be saved to external memory.

Save B-SCOPE

To save the internally stored band scope to external memory, access the COPY EXT-MEM menu using the key sequence PUSH  (F) PRESS  (O JT).

Select the "SAVE" option, PUSH  (PASS) to toggle between load and save.

Next select the EM8200 bank you wish to save using the $\leftarrow \rightarrow$ keys (0, 1, 2 or 3).

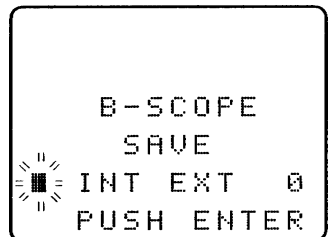

PUSH  the \downarrow key to move the cursor to the left of the "ALL-DATA" legend, use the $\leftarrow \rightarrow$ keys to select "B-SCOPE".







PUSH  **ENT** to start the band scope data save. The legend "EXT-MEM SAVING !!" will be briefly displayed, the save process will only take a second to complete. Once the save is complete, the LCD will revert to its previous display (VFO, scan or search etc).

Load B-SCOPE (for future display)

It is presumed that you have already saved band scope data to one of the four EM8200 memory locations. Make sure that global write protect is not set or the data load will be unsuccessful and no data will be loaded. It is also possible to load a band scope trace directly into the band scope display for immediate viewing, this is explained at the end of this section.

If you wish to retain any currently displayed band scope, save it to one of the four locations in the external EM8200.



Access the COPY EXT-MEM menu using the key sequence PUSH  **F** PRESS  **0 JT**.

Select the "LOAD" option, PUSH  **PASS** to toggle between load and save. Next select the EM8200 bank you wish to save using the $\leftarrow \rightarrow$ keys (0, 1, 2 or 3). PUSH  the \downarrow key to move the cursor to the left of the "ALL-DATA" legend, use the $\leftarrow \rightarrow$ keys to select "B-SCOPE".



PUSH  **ENT** to start the band scope data load. The legend "EXT-MEM LOADING !!" will be briefly displayed, the band scope load process will only take a second to complete. Once the load is complete, the LCD will revert to its previous display (VFO, scan or search etc).

Recalling a stored band scope for viewing

The loaded band scope may be recalled to LCD, the key sequence depends upon whether the EM8200 is still fitted or not.



With EM8200 'not' fitted: Use the key sequence PUSH  **F** PRESS  **SCOPE** to recall the loaded band scope to LCD.

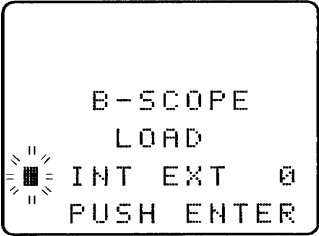

With EM8200 fitted: Use the key sequence PUSH  **F** PRESS  **SCOPE** to access the band scope load menu, the legend "B-SCOPE LOAD" will be displayed.

PUSH  the **PASS** key to toggle the memory selection between INTERNAL "INT" and EXTERNAL "EXT", the default is "EXT". As band scope data has been transferred to internal memory select "INT". PUSH  **ENT** to recall the trace to LCD.



Loading a band scope directly from external memory for viewing

It is possible to load a band scope directly from EM8200 external memory for immediate display on the LCD. Use the key sequence PUSH  (F) PRESS  (SCOPE) to access the band scope load menu, the legend "B-SCOPE LOAD" will be displayed.

PUSH  the (PASS) key to toggle the memory selection between INTERNAL "INT" and EXTERNAL "EXT", the default is "EXT". Select "EXT" then use the main dial or ⇐ ⇨ keys to select one of the EM8200 memory locations (0, 1, 2 or 3). PUSH  (ENT) to recall the trace directly to the LCD for immediate viewing.

 **Note:** For further information regarding the band scope, please refer to **section 15** of this manual.

(19) Trouble shooting

Should the AR8200 appear to act strangely, check out the following suggestions to see if the problem can be overcome. Failing this, switch off the AR8200, disconnect any external power connection and remove one battery from the radio (if you have batteries fitted). Wait for at least 30 seconds then re-fit the battery (if in use) or re-connect the external power and switch the radio on again with a **PRESS**  of the **PWR** key.

Check to see if the problem has cleared.

19-1 Soft reset of microprocessor



If removing power and switching the AR8200 off / on does not help, try a soft reset of the microprocessor.

Soft reset is achieved by powering-up the radio with the **CLEAR** key held, do not release the **CLEAR** key until the opening message has performed and a frequency is displayed in 2VFO mode.

All scan & search environments are cleared, bank link is set off and the receiver frequency will be set to 88.000 MHz for both VFO-A and VFO-B. The beep will be enabled and set to default as will lamp and LCD contrast. All memory and search bank data will be intact.

19-2 Other trouble shooting suggestions

AR8200 will not power on. Check that the set is connected to external power (12V d.c.) or that batteries are fitted and are fully charged.

There is no audio. It may simply be that the squelch is closed or volume is turned down. **PRESS**  **and hold** the  **MONI** key and adjust the volume to a comfortable level. Ensure that no external loudspeaker, headphone or earphone is in use. Check that the band scope is not in operation.



AR8200 display is strange and there is no audio. Check that the band scope is not in operation, **PUSH**  **2VFO**.

There is no receive. Check that a suitable aerial is connected to the AR8200 and the attenuator is not switched on (ATT legend). Check that VOICE squelch is not in use (VSQ legend), check that LEVEL squelch (LSQ legend) is not in operation.

Intermittent receive. Check that priority is not engaged and the band scope is not in operation. Ensure that POWER SAVE is not enabled in the CONFIG menu.

Strange audio. Ensure that you are using the correct receive mode and are tuned to the centre of the signal. In most cases the AR8200 can automatically select the correct parameters. **PRESS**  **3CM** to select auto-mode.

No frequency display. If all other LCD characters appear normal check that the FREQ DISP facility is not set OFF in the CONFIG menu.



LCD is dim. Check that the contrast is set to a sensible level (not too low) in the CONFIG menu (around 10). An LCD test facility is provided. **Power-up the AR8200 while holding** , **PRESS**   to switch off the test.

LCD legends are all shown. Check that the contrast is set to a sensible level (not too high) in the CONFIG menu (around 10).

Cannot save any data. Ensure that write protect is not set. It is also possible for data not to be saved if the batteries are very low in charge.

Cannot enter frequencies. Ensure that you are entering frequencies in MHz format between the range of 0.100 MHz and 2040.000 MHz.

Keypad inoperative. Ensure that the key lock is not engaged (key symbol on the LCD).

PRESS  the  K.L. key to toggle keylock on / off.

Keypad and operation is sluggish. Ensure that POWER SAVE is not enabled in the CONFIG menu.

No SCAN. Check that you have memory data saved and that all channels are not locked out (PASS).

No SEARCH. Check that you have search data programmed and that all frequencies are not locked out (PASS).

19-3 Trouble shooting - Take note of the following

Select scan cannot operate in conjunction with **mode scan**. Select scan is disabled when priority is engaged.

Priority is disabled when the band scope is in operation. If a long **DELAY time** is set, priority 'eats' away at delay time causing it to shorten. If the optional CT8200 slot card is in use, **CTCSS SEARCH** cannot operate with priority engaged due to the required CTCSS search time being quite long.

When **POWER SAVE** is on, response from the AR8200 may be sluggish and there will be periods of no receive.

If the  ^{MONI} key is being used to display a frequency with **FREQUENCY OFFSET** in use, this offset frequency cannot be stored into memory.

The **squelch** may not operate promptly (as you may expect) when monitoring in **USB, LSB, CW and NAM modes** due the narrow bandwidths employed. This is a fundamental characteristic of the squelch circuit. Audio may remain even though the "S" squelch legend may have disappeared for a couple of seconds. It is suggested that LEVEL squelch be used as an alternative in this situation.

There are no internal operator adjustments. In the unlikely event of servicing being required, please contact your dealer for technical assistance.

(20) Optional accessories

Slot cards:

Five slot cards are available, only one may be fitted at a time.

1. **VI8200** Voice inverter (analogue) in 157 steps.
2. **CT8200** CTCSS squelch & search.
3. **TE8200** Tone eliminator in 256 steps.
4. **RU8200** Chip based recording and playback, 20 seconds approx.
5. **EM8200** External extended memory, backup 4,000 memories, 160 search banks (can hold as much data as 4 x AR8200).

Leads:

Three leads are available for use with the option socket.

1. **CR8200** tape recording lead.
2. **CO8200** data clone lead.
3. **CC8200** computer control lead with level shift (available with imperial (PC98) & metric (DOSV) screws) and supplied with RS232 protocol listing in PDF format.

Aerials:

There are many suitable aerials available on the market, these include.

- | | |
|---------------|---|
| DA900 | VHF/UHF flexible whip 245mm in length. |
| TW500 | VHF/UHF telescopic whip aerial. Comprises of six sections, extends to 625mm in length. |
| MA500 | VHF/UHF whip aerial on magnetic base with 4m of coaxial cable. Base is 85mm in diameter, total height is 720mm. Coverage is 25 to 1300 MHz. |
| DA3000 | 16 element discone aerial with 15 of coax. Coverage is 30 MHz to 2 GHz. |
| SA7000 | Passive twin element wide band aerial with 15m of coax. Coverage is 30 kHz to 2 GHz. |
| LA320 | Desktop loop aerial 1.6 MHz to 15 MHz. Optional elements available for LW & MW. Supplied with BNC lead. |
| ABF125 | VHF airband filter for increased adjacent channel selectivity. |

(21) Aerial (antenna), earths & propagation

The subject of aerial choice and earth can be quite complex. There are many advantages and disadvantages to consider before connecting an external aerial to your receiver. One interesting phenomena is that aerial theory and practice can be surprisingly different. Keeping common sense in mind it is one of the few remaining areas for listeners to easily experiment and often achieve fantastic results.

Whip aerial

The supplied semi-flexible whip aerial should give adequate results for general hand-held operation on the VHF and UHF bands. A longer wire aerial or telescopic whip should be considered for listening to the short wave bands. The AR8200 is supplied with a ferrite bar aerial for medium wave reception, for best results, rotate the receiver as the bar aerial is directional.

Mounting location

It is important to mount any external aerial as high as possible and in clear space although this is more important at VHF frequencies than for short wave. If possible the aerial should have a clear path to the horizon. Results are usually disappointing when an installation is in a loft space.

Long wire aeriels

For short wave reception a random length of long wire approximately 10 to 20 metres in length forms a good compromise. The wire should be connected to the centre pin of a BNC plug then connected to the BNC aerial input on the top of the AR8200. If possible try to locate the receiver close to a window so that the wire has the shortest and most direct run from the rear of the receiver to the outside world.

Discone

For wide coverage in the VHF-UHF bands a compromise has to be met and the most popular aerial is a discone (AOR DA3000). Their appearance is like a large spider or umbrella without the covering material, the better models have about 16 elements. Typical usable coverage starts from about 25 MHz and extends continuously to 500 MHz 1300 MHz or even 2000 MHz. The coverage peaks and dips throughout it's range as the elements interact to provide the widest possible coverage. Due to their necessary construction discone aeriels are a little prone to "wind noise" due to vibration and possible damage in severe gales.

Filters

A VHF civil AIRBAND FILTER is available (ABF125), this will help minimise the possible effects of breakthrough when listening to VHF airband in Band-II VHF high signal areas or when connected to external aeriels.

Earth systems

A separate EARTH connection made to the outer (braid) connector of the BNC plug may improve aerial efficiency and reduce noise. Suitable earth points include connection to a water pipe, central heating radiator or external earth rod. If fitting a separate external earth rod, consider the implications carefully if your mains supply uses Protective Multiple Earth (PME) system. If in doubt consult an experienced electrician. Connecting an external earth wire may greatly reduce the local noise encountered when listening on the short wave bands. It is very important to provide a good earth should you use an aerial tuning unit.

A short length of thick gauge earth wire may be connected to a nearby central heating radiator or water pipe but **never use a gas pipe for earthing**. Ideally a separate earth rod should be used but the length between the receiver and rod becomes restrictive, if too long the earth system may well "pick up" noise rather than remove it.

Propagation

VHF and UHF transmissions generally only propagate relatively short distances when compared to short wave signals. For all intents and purposes they may be considered as line-of-sight plus a bit.

Where as point to point communication between mobile users or when in built up areas may only be a couple of kilometres, aircraft at heights of 30,000 feet may be heard for many tens of kilometres (100 to 300 with the right conditions).

Unlike VHF and UHF transmissions which generally propagate only on a localised basis (to the horizon plus a small amount), short wave transmissions may travel for many thousands of kilometres. Depending upon the frequency in use, time of day, season of the year and sun spot activity, transmissions may propagate completely around the World.

Luckily the frequency spectrum of short wave is often reflected back down to Earth by the upper layer of the Earth's atmosphere called the ionosphere. When the reflected signals reach the Earth again they may either be received or reflected back up into space. If lucky, they will be reflected by the ionosphere yet again down toward the Earth providing reception into another and possibly more distant location. Depending upon the time of day and desired skip distance, different frequencies will be selected by Radio Amateurs and commercial users such as Oceanic Air Traffic.

(22) Specification

Frequency Range:	500 kHz to 2040 MHz (Actual frequency input 100 kHz to 2040 MHz, performance between 100 kHz to 530 kHz is not guaranteed).		
Receive Modes:	WFM, NFM, SFM, WAM, AM, NAM, USB, LSB, CW		
Sensitivity:	<p>500 kHz ~ 2.0 MHz AM: 3.50 μV (10dB S/N)</p> <p>2.0 MHz ~ 30 MHz SSB: 1.50 μV (10dB S/N) AM: 2.50 μV (10dB S/N)</p> <p>30 MHz ~ 470 MHz SSB: 0.30 μV (10dB S/N) AM: 0.70 μV (10dB S/N) NFM: 0.35 μV (12dB SINAD) WFM: 1.00 μV (12dB SINAD)</p> <p>470 MHz ~ 1 GHz NFM: 0.50 μV (12dB SINAD) WFM: 1.50 μV (12dB SINAD)</p> <p>1.0 GHz ~ 1.3 GHz NFM: 1.00 μV (12dB SINAD)</p> <p>1.3 GHz ~ 2.039 GHz NFM: 2.50 μV (12dB SINAD)</p>		
Selectivity:	SSB/NAM	3kHz (-6dB), 9kHz (-60dB)	
	AM/SFM	9kHz (-6dB), 20kHz (-40dB)	
	WAM/NFM	12kHz (-6dB), 25kHz (-40dB)	
	WFM	150kHz (-3dB), 380kHz (-20dB)	
Power Consumption:	190mA (nominal), 145mA (stand by), 25mA (power save). 4 x AA internal cells or 12V d.c. external supply		
Dimensions:	61(W) x 143(H) x 39(D) mm		
Weight:	196g (335g including NiCads)		
Memory channels:	1,000 (20 banks)		
Select scan channels:	50		
Priority channels:	1		
Search banks:	40		
PASS channels:	50 per search bank + 50 for VFO search		
Scan/Search Rate:	Maximum 37.42 steps per second <i>With auto-mode off, 10 kHz step, * lock time 2mS, * Squelch wait 15mS. (*this value is preset and varies depending upon band and step, squelch wait times of 15mS, 25mS and 30mS are employed).</i>		

Specifications subject to change without notice due to continuous development of the receiver. E&OE.



AOR Ltd

2-6-4 Misuji, Taito-ku, Tokyo 111-0055, Japan.

Tel: +81 3 3865 1681 Fax: +81 3 3865 1697

post@orja.com www.orja.com



Due to continuous development of our products, the AR8200 has evolved into the Mk2 and Mk3 versions. As a result, operation differs from the original AR8200 in a few areas, please note the following changes to the AR8200 operating manual:

1 The front 'ten-key' keypad has been rearranged in line with customer requests placing the '0' zero key underneath the '8' eight key, as is standard practice with push button telephones. On page 9 section 1-5-1 of the English language operating manual, the graphic should now look like (the revised keypad has been used on the Mk3 and Mk2 versions):

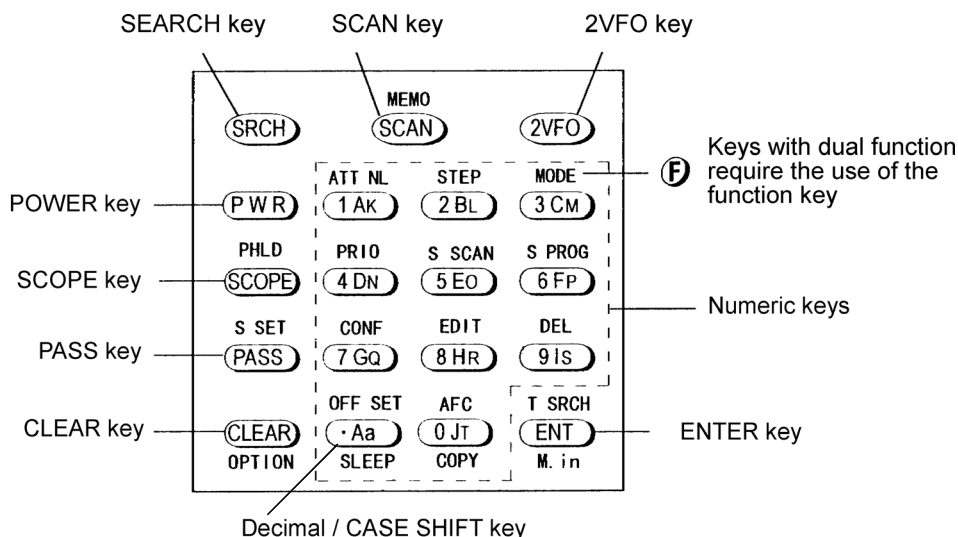

2 The Mk3 and Mk2 versions feature a built-in TCXO (Temperature Controlled Crystal Oscillator) in place of the reference crystal. This ensures the best levels of frequency stability and minimum spuri.

3 In place of the previous rubber covered aerial, a telescopic whip on a swivel base is supplied (Mk3 and Mk2 versions). The whip provides the very best performance, especially on the VHF bands with the ability to adjust the length of the telescopic whip aerial to 'peak' received signal strength (the higher the frequency, the shorter the aerial). An alternative flexible smaller whip aerial is available as an option where durability and smaller size is important. Please refer to page 7 section 1-4 of the English language operating manual, line two of the table should now read "telescopic whip aerial".

4 The relationship between level squelch and signal meter has been revised. This affects VFO SEARCH LEVEL SQUELCH (page 47 section 4-4-3 of the English language operating manual), SCAN LEVEL SQUELCH (page 68 section 7-8-2 of the English language operating manual) and PROGRAM SEARCH LEVEL SQUELCH (page 84 section 8-7-2 of the English language operating manual).

In each case, the following table replaces that previously employed:

	1	2	3	4	5	6	7	8	9	10	11	12	13	14
Mk2	8	13	18	24	29	35	39	44	50	55	58	62	71	77
Mk3	7	15	18	24	28	31	42	50	59	64	72	80	85	89

As a result, the typical level at which the "★" legend will be extinguished has changed.

5 The batteries supplied with the AR8200 have been changed. To ensure that a completely full charge is established, please assume the full charge time as follows, this replaces the reference given on page 19 section 1-6-4 of the English language operating manual.

AR8200	NiCads, 700mAh	12 hour charge
Mk2	NiCads, 1000mAh	14 hour charge
Mk3	NiMH, 1500mAh	22 hour charge

SEE OVER >>>

The AR8200 receiver employs standard 'AA' size batteries, so a range of different types can be used (NiCad, NiMH, alkaline etc). For this reason, the charging circuit cannot be optimised for any one specific type. It is most important that you do not over-charge the batteries and do not keep topping them up without first running them down. If the batteries are flat, do not attempt to 'charge and operate' the radio for the first hour of charging, this would lead to an increase in internal heat generated by the AR8200. Do not connect an external power supply, mobile power lead or charger if dry / alkaline batteries are fitted.

In order to provide the optimum level of charge and life-span from the NiMH batteries (Nickel Metal Hydride) supplied with the Mk3, **use of a specialist dedicated external battery charger is recommended**, they are readily available from electrical suppliers. The AR8200 is not designed to charge rechargeable alkaline batteries.

6 The design of the battery compartment and compartment cover has been revised to assist the easy replacement of batteries (Mk3 and Mk2), refer to page 16 section 1-6-1 of the English language operating manual. The cabinet colour of the AR8200 was green, the Mk3 and Mk2 cabinet is black.

7 The operation of LCD/keypad illumination has been revised in the Mk3 version, refer to page 106 section 14-2 of the English language operating manual. When operating from internal batteries with AUTO LAMP selected, the illumination will activate for a few seconds when the squelch first opens. This is very useful for identifying transmission at night-time without using up excessive power from the batteries.

8 The frequency coverage of the Mk3 version has been extended to 3GHz, the specified range is now 530kHz to 3GHz with actual minimum frequency input of 100kHz.

9 Refer to the following specification for the Mk3 version which replaces that printed on page 140 of the English language operating manual:

Frequency Range:	530 kHz to 3000 MHz (3GHz)* * Cell blocked in the USA for FCC rules	
Receive Modes:	WFM, NFM, SFM, WAM, AM, NAM, USB, LSB, CW	
Sensitivity:	500 kHz ~ 1.9 MHz	AM: 3.5 μ V (10dB S/N)
	1.9 MHz ~ 30 MHz	AM: 2.5 μ V (10dB S/N)
	30 MHz ~ 470 MHz	AM: 1.5 μ V (10dB S/N)
		NFM: 0.85 μ V (12dB SINAD)
		WFM: 1.5 μ V (12dB SINAD)
	470 MHz ~ 1040 MHz	NFM: 0.9 μ V (12dB SINAD)
	1040MHz ~ 2040 MHz	NFM: 9.0 μ V (12dB SINAD)
	2040 MHz ~ 3000 MHz	NFM: 25 μ V (12dB SINAD)
Selectivity:	SSB/NAM	3kHz (-6dB) / 9kHz (-40dB)
	AM/SFM	9kHz (-6dB) / 20kHz (-40dB)
	WAM/NFM	12kHz (-6dB) / 25kHz (-40dB)
	WFM	150kHz (-3dB) / 360kHz (-20dB)
Aerial input:	BNC nominal 50 OHM	
Audio output:	120mW (8 OHM) THD 10%	
Input voltage:	9 ~ 16V DC	
Power Consumption:	190mA (nominal)	
Operating temperature:	-5°C to +50°C	
Dimensions:	61(W) x 143(H) x 39(D) mm approx excluding projections	
Weight:	340 g approx including batteries and aerial	

Specifications subject to change without notice due to continuous development of the receiver. E&OE.

AR8200 Quick reference sheet

© AOR UK LTD 1998

This guide is designed to be used in conjunction with the operating manual and gives a short guide to **some** of the functions. There are many innovative facilities available on the AR8200, use this guide if you wish, to act as an aid to your memory until you become more familiar with the set.

The following conventions apply to this guide:

PUSH **Push and release the key quickly** to access the required facility.

PRESS **Press and HOLD the key for more than one second** to access the second function, sometimes this is in conjunction with the **(F)** key.

Text in chevrons < > indicates further menu options available from the point you have reached. These are usually accessed by the side arrow keys. Numbers next to an item indicate the page and section numbers in the operating manual - {P(section)}

For example, {82(8-7)} indicates page number 82, section 8-7.

- K.L. **PRESS** to engage the keylock.
- MONI **PRESS** to force squelch open so weak signals are not missed. In band scope mode enables monitoring of a signal on a cursor. Enables monitoring of the other frequency in duplex mode. **PUSH** **(ENT)** while holding ○ MONI to move the duplex frequency, or the receiving frequency in band scope mode, to VFO.
- (ENT)** **PUSH** to return from remote mode or write to quick memory. **PRESS** to write the current frequency to a memory channel <TEXT> <PROTECT>.
- (SCOPE)** **PUSH** to start band scope operation.
- (CLEAR)** **PUSH** to abort any key sequence.
- (F)** **PRESS** to set up option units {121(18-1)}
- (SRCH)** **PUSH** to access "SRCH -GROUP" menu {82(8-7)} <SRCH-GROUP> <BANK LINK> <DELAY> <LEVEL squelch> <VOICE squelch> <FREE> <AUTO STORE> <DELETE J>.
- (SCAN)** **PUSH** to access "SCAN-GROUP" menu {67(7-8)} <SCAN-GROUP> <bank LINK> <DELAY> <LEVEL squelch> <VOICE squelch> <FREE> <MODE SCAN>.
- PRESS** to access <BANK SELECT> <BANK TEXT> <BANK WIDTH> <BANK PROTECT>.
- (2VFO)** **PRESS** to access VFO environment menu {46(4-4)} <VFO SCAN> <DELAY> <LEVEL> <VOICE> <FREE> <AUTO STORE> <DELETE J> <QUICK MEMORY>.
- (SCOPE)** **PUSH** to enable peak hold in Band scope.
- PRESS** to recall Band scope trace from memory {115(15-10)}.
- (1 AK)** **PUSH** Attenuator on/off {38(3-11)}.
- PRESS** Noise limiter on/off {38(3-12)}.
- (2 BL)** **PUSH** to enter step size. **PUSH** **(PASS)** <STEP ADJUST> {33(3-9)}.
- (3 CM)** **PUSH** to change receive mode {29(3-7-2)}.
- PRESS** as a shortcut to auto mode.
- (4 DN)** **PUSH** to set priority on/off {60(6-1)}.
- PRESS** to set priority channel {61(6-2-1)} <PRIO SET> <INTERVAL>.
- (5 EO)** **PUSH** to start select scan {71(7-9)}.
- (6 FP)** **PUSH** to access "SRCH PROG" menu {78(8-4)}. <LO Freq> <HI Freq> <MODE SET> <SET STEP> <TEXT> <PROTECT>.
- (7 GQ)** **PUSH** to access configuration menu {106(14)}. <BEEP> <LAMP> <CONTRAST> <POWER-SAVE> <AUTO PWR-OFF> <REMOTE> <FREQ DISP> <WRITE PROTECT> <OPENING MESSAGE>.
- (8 HR)** **PUSH** to access "COPY MEM-CH" menu {88(9-1)}. <EDIT COPY memory channel> <EDIT COPY memory bank> <EDIT COPY search bank> <EDIT MOVE memory channel> <EDIT SWAP memory channel> <EDIT memory channel contents> <EDIT search protect>.
- (0 JT)** **PUSH** to toggle AFC on/off {39(3-13)}.
- (9 IS)** **PUSH** to delete the currently displayed memory channel in M.RD {57(5-5)} <MEM DELETE> <PUSH ENTER> ACCESS TO DELETE MENU FROM SEARCH, as below. {94(10-1)}.
- PRESS** to access delete menu {94(10)} <DEL SRCH> <DELSEARCH PASS> <DEL VFO PASS> <DELETE MEM-BANK> <DELETE SEL-CH> <PRO-CH> <MEM PASS>.
- PRESS** to access "COPY RS232" menu {119(17-2-1)}. <LOAD SAVE> <ALL-DATA> <ALL-MEM> <MEM BANK> <ALL-SRCH> <SRCH-BANK>.
- When used in conjunction with EM8200 {128(18-6)}. <COPY EXT-MEM> <LOAD SAVE 0> <ALL DATA> <NEXT>.....
- Aa **PUSH** to access offset menu {36(3-10)}.
- PRESS** to access sleep menu {116(16)}.
- (ENT)** **PUSH** to access text search menu {102(12-2)}.

The following keys act as short cuts when entering text {101(12-1)}

When in text menus, the ⇐ ⇨ keys are used to move cursor position left and right.

The (PASS) key is used to delete the current character and remaining line to the right of the cursor.

The MAIN DIAL cycles through upper / lower case letters, numbers and characters.

The numeric keys provide short cuts to several characters:

- (1AK) is a short cut for **BLANK**
- (2BL) is a short cut for **number 1**
- (3CM) is a short cut for **upper case A**
- (4DN) is a short cut for **upper case Z**
- (5EO) is a short cut for **lower case a**
- (6FP) is a short cut for **lower case z**
- (7GQ) is a short cut for Japanese character set
- (8HR) is a short cut for Japanese character set
- (9IS) is a short cut for various characters & symbols

PUSH (ENT) to accept the input and return to the standard display.

Shortcut text entry from the keypad {104(13-1)}

While in a text input menu, PRESS (F) to display *flashing* "FUNC" then refer to the following table. Look for the required character in the table then PUSH the key shown to the horizontal-left followed by the vertical key shown above the required character (do not push both keys together). The first key push will produce a character on the screen which will be replaced with the required character when the second key is pushed, the cursor will then move one place to the right.

		2. PUSH this key second									
		(1AK)	(2BL)	(3CM)	(4DN)	(5EO)	(6FP)	(7GQ)	(8HR)	(9IS)	(0JT)
1. PUSH this key first	(1AK)	ア	イ	ウ	エ	オ	A	B	C	D	E
	(2BL)	カ	キ	ク	ケ	コ	F	G	H	I	J
	(3CM)	サ	シ	ス	セ	ソ	K	L	M	N	O
	(4DN)	タ	チ	ツ	テ	ト	P	Q	R	S	T
	(5EO)	ナ	ニ	ヌ	ネ	ノ	U	V	W	X	Y
	(6FP)	ハ	ヒ	フ	ヘ	ホ	Z	?	!	-	/
	(7GQ)	マ	ミ	ム	メ	モ	¥	&			
	(8HR)	パ	ク	一)	ヨ	*	#	┌		
	(9IS)	ラ	リ	ル	レ	ロ	1	2	3	4	5
	(0JT)	ワ	ヲ	ン	ッ	□	6	7	8	9	0

General trouble shooting

If you experience problems with the set, refer to page 136 of the operating manual. The last resort before calling your supplying dealer for help is a soft reset of the microprocessor. This is achieved as follows:

Soft reset is achieved by powering-up the radio with the (CLEAR) key held, do not release the (CLEAR) key until the opening message has performed and a frequency is displayed in 2VFO mode.

All scan & search environments are cleared, bank link is set off and the receiver frequency will be set to 88.000 MHz for both VFO-A and VFO-B. The beep will be enabled and set to default as will lamp and LCD contrast. All memory and search bank data will be intact.