

144/430MHz DUAL BAND FM TRANSCEIVER

DJ-V57

Instruction Manual

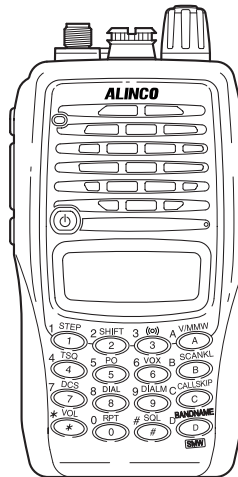

Thank you for purchasing your new Alinco transceiver. Please read this manual carefully before using the product to ensure full performance, and keep this manual for future reference as it contains information on after-sales service.

In case addendum or errata sheets are included with this product, please read those materials and keep them together with this instruction manual for future reference.

NOTICE / Compliance Information Statement

This equipment has been tested and found to comply with the limits for a Class B digital device, pursuant to part 15 of the FCC Rules.

These limits are designed to provide reasonable protection against harmful interference in a residential installation.

This equipment generates, uses, and can radiate radio frequency energy and, if not installed and used in accordance with the instruction manual, may cause harmful interference to radio communications. However, there is no guarantee that interference will not occur in a particular installation. If this equipment does cause harmful interference to radio or television reception, which can be determined by turning the equipment off and on, the user is encouraged to try to correct the interference by one or more of the following measures:

- Reorient or relocate the receiving antenna.
- Increase the separation between the equipment and receiver.
- Connect the equipment into an outlet on a circuit different from that to which the receiver is connected.
- Consult the dealer or an experienced radio/TV technician for help.



**Tested to Comply
With FCC Standards
FOR HOME OR OFFICE USE**

Information in this document is subject to change without notice or obligation. All brand names and trademarks are the property of their respective owners. Alinco cannot be liable for pictorial or typographical inaccuracies. Some parts, options and/or accessories are unavailable in certain areas. Changes or modifications not expressly approved by the party responsible for compliance could void the user's authority to operate the equipment.

144/440MHz FM amateur radio handheld transceiver DJ-V57T

This device complies with Part 15 of the FCC Rules. Operation is subject to the following two conditions: (1) This device may not cause harmful interference, and (2) this device must accept any interference received, including interference that may cause undesired operation.

Manufacturer:

ALINCO, Inc.
Yodoyabashi Dai-bldg. 13F
4-4-9 Koraibashi, Chuo-ku,
Osaka 541-0043 Japan



Conformity Information

Alinco, Inc. Electronics Division hereby declare on our sole responsibility that the product(s) listed below comply the essential requirements of the Directive 1999/5/EC, The council of 3/9/99 on Radio Equipment and Telecommunication Terminal Equipment and the mutual recognition of their conformity and with the provisions of Annex, after having performed the required measurements at Notified Bodies per Standards, and relative certificate(s) or document(s) can be reviewed at <http://www.alinco.com/Ce/>

DJ-V57E FM amateur radio handheld transceiver

144.000~145.995MHz / 430.000~439.995MHz



This device is authorized for use in all EU and EFTA member states. An operator's license is required for this device.

Copyright © All rights reserved. No part of this document may be reproduced, copied, translated or transcribed in any form or by any means without the prior written permission of Alinco. Inc., Osaka, Japan. English edition Printed in Japan.



Check with your local waste officials for details on recycling or proper disposal in your area.



Contents







NOTICE / Compliance Information Statement	2
Contents	4
Warning	7
Introduction	12
Before transmitting	12
1.Features	13
1.1 Accessories	13
2.Accessories	14
2.1 Installations	14
2.1.1 Antenna	14
2.1.2 Hand Strap	14
2.1.3 Belt Clip	14
2.1.4 Battery Pack	15
2.1.5 Prevent Short Circuiting the Battery Pack	18
3.Names and Operations of Parts	19
3.1 Names and Operations of Keys and Ports	19
3.2 Keypad	21
3.3 Display (LCD)	22
4.Basic Operation	23
4.1 Turning On the Power	23
4.2 Adjusting the Audio Output (Volume)	23
4.3 Adjusting the Squelch	23
4.4 Operating Modes	24
4.5 Setting the Frequency in the VFO Mode	25
4.5.1 Setting the Frequency	25
4.5.2 Setting the Tuning Step	26
4.5.3 Shift Direction and Offset Frequency Settings	27
4.6 Memory Mode	28
4.6.1 How to Program Memory Channel(s)	28
4.6.2 Recalling a Memory Channel	28
4.6.3 Deleting a Memory Channel	28
4.6.4 Quick Program Memory Channel(s)	29
4.6.5 Transmitter Detecting Function	29
4.6.6 Programming a Repeater-Access Function Setting	30
4.6.7 Programmable Parameters in Memory Channels	30

4.7	Call-Channel Mode.....	31
4.8	Receiving.....	31
4.8.1	Monitor Function.....	32
4.9	Transmitting.....	32
4.9.1	Selecting the Output Level.....	32
5.	Useful Functions.....	33
5.1	Scan Modes.....	33
5.1.1	VFO-Scan.....	33
5.1.2	Memory-Scan.....	33
5.1.3	Setting Skip Channels.....	34
5.2	Keylock.....	34
5.3	Tone-Burst.....	34
5.4	Naming Memory Channels.....	35
5.4.1	Setting Name-Tag.....	35
5.4.2	Using the Channel Name Function.....	35
5.5	Lamp.....	35
6.	Selective Calling.....	36
6.1	Tone Squelch (TSQ).....	36
6.1.1	Setting the Tone Squelch.....	36
6.1.2	Switching Off the Tone Squelch.....	37
6.1.3	To Differentiate the ENC/EDC Tones.....	37
6.1.4	Tone Squelch Operation.....	37
6.2	DCS.....	37
6.2.1	Setting the DCS.....	37
6.2.2	Changing the DCS Code.....	38
6.2.3	Switching Off DCS.....	38
6.2.4	DCS Operation.....	38
6.2.5	DET Mode in DCS Operation.....	38
6.3	DTMF Tone Encoding.....	39
6.4	Auto Dialer.....	40
6.4.1	Setting the Auto Dialer.....	40
6.4.2	Generating the Auto Dialer Codes.....	40
6.4.3	Redial (While Receiving).....	41
7.	Special Functions.....	42
7.1	Repeater-Access.....	42
7.2	Program Scan.....	42
7.3	VOX.....	43
7.4	ALERT.....	43
7.5	Battery Type Setting.....	44
7.6	Battery Refresh.....	44

8.Set Mode	45
8.1 Set Mode Operation.....	45
8.2 Entering the Set Mode.....	45
8.3 Available Parameters.....	46
8.3.1 Menu 1 Battery Save (BS) Function.....	46
8.3.2 Menu 2 Timer/Busy Scan Setting.....	46
8.3.3 Menu 3 Beep Function.....	46
8.3.4 Menu 4 VOX delay time setting.....	46
8.3.5 Menu 5 Auto-Power-Off Setting.....	47
8.3.6 Menu 6 FM / NFM Setting.....	47
8.3.7 Menu 7 ATT (Attenuator) Setting.....	47
8.3.8 Menu 8 Clock Shift Setting.....	48
8.3.9 Menu 9 Busy Channel Lockout Setting.....	48
8.3.10 Menu 10 Tone-Burst Frequency Setting.....	49
8.3.11 Menu 11 Time Out Timer (TOT) Setting.....	49
8.3.12 Menu 12 TOT Penalty Time.....	49
8.3.13 Menu 13 DTMF WAIT Time.....	50
8.3.14 Menu 14 DTMF First Digit Burst Time.....	50
8.3.15 Menu 15 DTMF Burst Time.....	50
8.3.16 Menu 16 DTMF Pause Time.....	50
8.3.17 Menu 17 Stand-by Beep/DTMF Setting.....	51
8.3.18 Menu 18 Mid power.....	52
9.Cloning and Packet Operation	53
9.1 Cloning.....	53
9.1.1 Cable Connection.....	53
9.1.2 Master/Slave Units.....	53
9.1.3 Master Unit Operation.....	54
9.1.4 Slave Unit Operation.....	54
9.2 Packet Operation.....	55
9.2.1 Packet Operation Connections.....	55
10.Maintenance and Reference	56
10.1 Troubleshooting.....	56
10.2 Resetting.....	57
10.2.1 All Resetting.....	57
10.2.2 Partial Resetting.....	57
10.3 Options.....	58
10.3.1 Microphone/Speaker Cable (EDS-14).....	59
10.3.2 Battery Packs.....	59
10.3.3 Using the Chargers.....	60
10.3.4 Dry Cell Case.....	66
11.Specifications	67







Warning





To prevent any hazard during operation of Alincon's radio product, in this manual and on the product you may find symbols shown below. Please read and understand the meanings of these symbols before starting to use the product.

 Danger	This symbol is intended to alert the user to an immediate danger that may cause loss of life and property if the user disregards the warning.
 Alert	This symbol is intended to alert the user to a possible hazard that may cause loss of life and property if the user disregards the warning.
 Caution	This symbol is intended to alert the user to a possible hazard that may cause loss of property or injure the user if the warning is disregarded.
	Alert symbol. An explanation is given.
	Warning symbol. An explanation is given.
	Instruction symbol. An explanation is given.





Alert

■ Environment and condition of use





-  It is recommended that you check local traffic regulations regarding the use of radio equipment while driving. Some countries prohibit or apply restrictions for the operation of radios and mobile- phones while driving.
-  Do not use this product in close proximity to other electronic devices, especially medical ones. It may cause interference to those devices.
-  Keep the radio out of the reach of children.
-  In case a liquid leaks from the product, do not touch it. It may damage your skin. Rinse with plenty of cold water if the liquid contacted your skin.
-  Never operate this product in facilities where radio products are prohibited for use such as aboard aircraft, in airports, in ports, within or near the operating area of business wireless stations or their relay stations.
-  Use of this product may be prohibited or illegal outside of your country. Be informed in advance when you travel.
-  The manufacturer declines any responsibilities against loss of life and/or property due to a failure of this product when used to perform important tasks like life-guarding, surveillance, and rescue.

-  Do not use multiple radios in very close proximity. It may cause interference and/or damage to the product(s).
-  Risk of explosion if battery is replaced with an incorrect type.
Dispose of, or recycle used batteries according to your local regulations.
-  The manufacturer declines any responsibilities against loss of life and property due to a failure of this product when used with or as a part of a device made by third parties.
-  Use of third party accessory may result in damage to this product. It will void our warranty for repair.



■ Handling this product





-  Be sure to reduce the audio output level to minimum before using an earphone or a headset. Excessive audio may damage hearing.
-  Do not open the unit without permission or instruction from the manufacturer. Unauthorized modification or repair may result in electric shock, fire and/or malfunction.
-  Do not operate this product in a wet place such as shower room. It may result in electric shock, fire and/or malfunction.
-  Do not place the product in a container carrying conductive materials, such as water or metal in close proximity to the product. A short-circuit to the product may result in electric shock, fire and/or malfunction.

■ About chargers



-  Do not use adapters other than having the specified voltage. It may result in electric shock, fire and/or malfunction.
-  Do not plug multiple devices using an adapter into a single wall outlet. It may result in overheating and/or fire.
-  Do not handle adapter with a wet hand. It may result in electric shock.
-  Securely plug the adapter into the wall outlet. Insecure installation may result in short-circuit, electronic shock and/or fire.
-  Do not use the adapter if the plug or socket contacts are dirty. Overheating and/or short-circuiting may result in fire, electric shock and/or damage to the product.

■ About power supply

-  Use only appropriate, reliable power supply of correct voltage and capacity.
-  Do not connect cables in reverse polarity. It may result in electric shock, fire and/or malfunction.
-  Do not plug multiple devices including the power supply into a single wall outlet. It may result in overheating and/or fire.

-  Do not handle a power supply with a wet hand. It may result in electric shock.
-  Securely plug the power supply to the wall outlet. Insecure installation may result in short-circuiting, electronic shock and/or fire.
-  Do not plug the power supply into the wall socket if the contacts are dirty. Short-circuit and/or overheating may result in fire, electric shock and/or damage to the product.
-  Do not modify or remove fuse-assembly from the DC cable. It may result in fire, electric shock and/or damage to the product.

■ Cigar-lighter cable

-  Do not use the cable at any other than the specified voltage. It may result in electric shock, fire and/or malfunction.
-  Do not handle cigar cable with a wet hand. It may result in electric shock.

■ In case of emergency

In case of the following situation(s), please turn off the product, switch off the source of power, then remove or unplug the power-cord. Please contact your local dealer of this product for service and assistance. Do not use the product until the trouble is resolved. Do not try to troubleshoot the problem by yourself.

- When a strange sound, smoke and/or strange odor comes out of the product.
- When the product is dropped or the case is broken or cracked.
- When a liquid penetrated inside.
- When a power cord (including DC cables, AC cables and adapters) is damaged.

-  For your safety, turn off then remove all related AC lines to the product and its accessories from the wall outlet if a thunderstorm is likely.





■ Maintenance

-  Do not open the unit and its accessories. Please consult with your local dealer of this product for service and assistance.







Caution





Environment and condition of use

-  Do not use the product in proximity to a TV or a radio. It may cause interference or receive interference.
-  Do not install in a humid, dusty or insufficiently ventilated place. It may result in electric shock, fire and/or malfunction.
-  Do not install in an unstable or vibrating position. It may result in electric shock, fire and/or malfunction when/if the product falls to the ground.
-  Do not install the product in proximity to a source of heat and humidity such as a heater or a stove. Avoid placing the unit in direct sunlight.
-  Be cautious of a dew formation. Please completely dry the product before use when it happens.

About transceiver

-  Be cautious of the whip antenna when carried in your shirt-pocket etc. It may make contact with your eye and cause injury.
-  Do not connect devices other than specified ones to the jacks and ports on the product. It may result in damage to the devices.
-  Turn off and remove the power source (AC cable, DC cable, battery, cigar cable, charger adapter etc.) from the product when the product is not in use for extended period of time or in case of maintenance.
-  Never pull the cord alone when you unplug AC cable from the wall outlet.
-  Use a clean, dry cloth to wipe off dirt and condensation from the surface of the product. Never use thinner or benzene for cleaning.

About power supply

-  Use only reliable power supply of specific DC output range and be mindful of the polarity of the cable and DC-jack.
-  Always turn off the power supply when connecting or disconnecting the cables.
-  When using an external antenna, make sure that the antenna ground is not common with the ground of the power supply.
-  European users: When a unit is powered from an external DC power source (adapter, power supply, cigar-plug etc.), make sure that this power supply has approval to the level of IEC/EN 60950.

■ Lightning

Any person is not safe outdoor during thunderstorm and lightning. This condition is getting worse if somebody keeps a hand-held radio; chances of being hit by lightning are doubled since lightning may hit a radio antenna as well. At this time, there is no hand-held radio having any kind of protection against lightning current (which is higher than 10 kA.). Note also that no car provides adequate protection of its passengers or drivers against lightning as well. Therefore, Alinco will not take responsibility for any danger associated with using its hand-held radios outdoor or inside the car during lightning.

■ Limited Power Source

Please note that the transceiver enclosure only provides mechanical protection of its internal parts; it will not contain a fire within the device if the fire starts under certain fault conditions. Alinco will not take responsibility for any fire hazard associated with powering the transceiver or charging its batteries using a power source which does not belong to the limited power sources in the meaning of EN 60950-1. Excluded from possible use with the transceiver are most car cigarette lighters and some DC (AC/DC) power supplies. Make sure that the power supply used with the transceiver is a limited power source.

■ Water-registant

The IPX7 designation provides for limited waterproofing of the radio. The specifications are immersion in one meter (approx 3ft) of still sweet water for up to 30 minutes. This compatibility is factory guaranteed for a period of one year provided all the jack covers are securely in place, any accessories connected must be genuine Alinco water-proof accessories and the radio has not been disassembled by the customer. The factory has tested and made the equipment compatible to IPX7 certification during engineering. However, please understand that this equipment is NOT certified IPX7 compliant but is designed to remain operational when used in rain, severe weather or in accidental cases of dropping it in water when used in extreme conditions and is in no way stating that you should attempt use the radio under water or submerge the radio for cleaning. Warranty will not cover radios that are water / salt damage due to negligence or misuse of the product.

Introduction

Thank you very much for purchasing this excellent Alinco transceiver. Our products are ranked among the finest in the world. This radio has been manufactured with state of the art technology and it has been tested carefully at our factory. It is designed to operate to your satisfaction for many years under normal use.

PLEASE READ THIS MANUAL COMPLETELY TO LEARN ALL THE FUNCTIONS THE PRODUCT OFFERS. WE MADE EVERY ATTEMPT TO WRITE THIS MANUAL TO BE AS COMPREHENSIVE AND EASY TO UNDERSTAND AS POSSIBLE. IT IS IMPORTANT TO NOTE THAT SOME OF THE OPERATIONS MAY BE EXPLAINED IN RELATION TO INFORMATION IN PREVIOUS CHAPTERS. BY READING JUST ONE PART OF THE MANUAL, YOU RISK NOT UNDERSTANDING THE COMPLETE EXPLANATION OF THE FUNCTION.

Before transmitting

There are many business radio stations operating in proximity to the ham bands. Be careful not to cause interference when transmitting around such radio stations. Even when amateur radio stations adhere to radio laws, there are unexpected cases of radio interference. When operating this product while traveling, please be very careful.

1. Features

This transceiver has the following main features.

- 144/430MHz dual-band handheld transceiver
- Choice of 3 power output levels (5/2/0.5W)
- Quick-write memory channels
- Direct frequency input through illuminated keypad
- High-grade water-resistant materials compatible to IPX7 *
- Rugged polycarbonate body resists dirt and dust
- Great audio with large 40mm internal speaker
- 39 CTCSS tone squelch (encode + decode) and 104 DCS
- Search-scan (programmed scanning) available on each band
- Tone burst function (1000, 1450, 1750 and 2100Hz)
- Two-touch repeater-setting access
- Internal VOX
- 2-level attenuator
- DTMF encode and auto-dialer

* Please read page 11 for more details.

1.1 Accessories

<T - version>

- EBP-65 Ni-MH battery pack (7.2V 700mA)
- EDC-146 (AC 120V) wall charger
- Belt clip
- Hand strap
- Instruction manual

<E - version>

- EBP-63 Li-ion battery pack (7.4V 1100mA)
- EDC-159E Li-ion rapid battery charger
- Belt clip
- Hand strap
- Instruction manual

NOTE:

Accessories may differ depending on the version you have purchased.
Please contact your local dealer for details of standard accessories and the warranty-policy.

2. Accessories

2.1 Installations

2.1.1 Antenna

Attaching the Antenna

1. Hold the antenna by its base.
2. Align the grooves at the base of the antenna with the protrusions on the antenna connector.
3. Slide the antenna down and turn it clockwise until it stops.
4. Confirm that the antenna is securely connected.

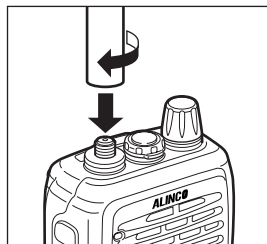

Removing the Antenna

Turn the antenna counter-clockwise to disconnect the antenna.

2.1.2 Hand Strap

Attach the hand strap as shown. There are two ways to attach it.

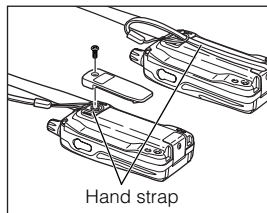

2.1.3 Belt Clip

Attaching the Belt Clip

1. Put the belt clip on the back of the unit, and turn the screw clockwise until it stops.
2. Confirm that the belt clip is securely attached.

* Tighten up the screw occasionally.

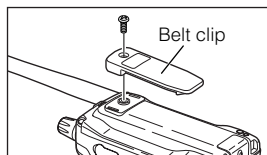

Removing the Belt Clip

Turn the screw counter-clockwise to remove the belt clip.

2.1.4 Battery Pack

For the specifications and the charging procedures, please refer to "Battery Packs"(page 59) and "Using the Chargers"(page 60).

Attaching the Battery Pack

Align the catches on the battery pack with the grooves on the unit, and close the latch until it clicks.

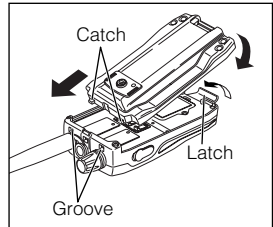

Removing the Battery Pack

Push the latch in the direction of the arrow, and pull out the battery pack.

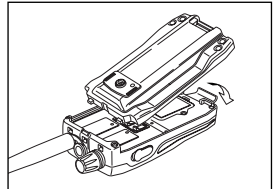



Caution

- Risk of explosion, generation of heat or leak of chemicals inside if the battery is replaced by an incorrect type. Use always the recommended types of batteries in this manual only.
- The battery pack isn't fully charged when shipped. It must be charged before use.
- Charging should be conducted in a temperature range of 0°C to +40°C (+32°F to +104°F).
- Don't modify, dismantle, incinerate or immerse the battery pack in the water as this can be dangerous.
- Never short-circuit the battery pack terminals, as this can cause damage to the equipment or lead to heating of the battery which may cause burns.
- Unnecessary prolonged charging (overcharging) can deteriorate battery performance.
- The battery pack should be stored in a dry place where temperature is in -10°C to +45°C (-14°F to +113°F) range. Temperatures outside this range can cause the battery liquid to leak. Exposure to prolonged high humidity can cause corrosion of metal components.
- Battery-packs are a consuming part. When its operating time becomes considerably short after a normal charge, please consider that the pack is exhausted and replace it with a new one.
- The battery pack is recyclable. Check with your local waste officials for details on recycling options or proper disposal in your area.
- Use specified genuine chargers only to charge battery packs. Use of other chargers may cause damage to products, you and your property.
- Li-ion battery packs can't be charged using DC-jack on the unit (Only Ni-MH battery packs can be charged).
- Even if you do not use the battery pack for a long time, charge it at least once every three months to prevent deterioration.

Charging the Battery Pack Using DC-Jack on the Unit

The unit can charge the EBP-65 and EBP-66 optional Ni-MH battery packs by supplying DC power through the DC-jack on the unit using EDC-146/147/148 wall chargers or an optional DC power supply (DC 12V~DC 16V, 1A or more: IEC/EN 60950-1 compliant) and a DC cable such as EDC-37.

1. Attach the battery pack by referring to "Battery Pack" (page 15).

2. Connect the AC adapter plug to the DC-jack on the unit then connect the charger's adapter to the wall outlet.

* AC adapter may look different.

3. Turn on the unit and set the battery charge parameters. (page 44)

* "Battery Type Setting"

Select BAT-NI+.

4. After completing the settings, a flashing  appears on the display. Make sure the icon is flashing then turn off the unit. It takes about 10 hours/30hours for EBP-65/66 respectively to complete the charge.

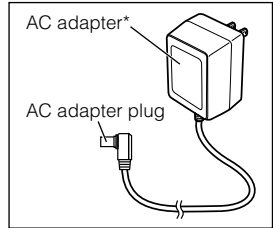

NOTE:

- Please read the general safety instructions included in the optional accessories to correctly and safely use them.
- EDC-146/147/148 can't be used as the adapter for operation. These adapters are for charging purposes only.
- Chargers can't perform the correct charge when the AC voltage is unstable.
-  flashes even EBP-65/66 aren't attached. To avoid short-circuit, never activate this function when the pack isn't attached to the unit.
- Li-ion battery packs can't be charged in this way.

2.1.5 Prevent Short Circuiting the Battery Pack

Be extra cautious when carrying the rechargeable battery pack; short circuiting will produce surge current possibly resulting in fire.

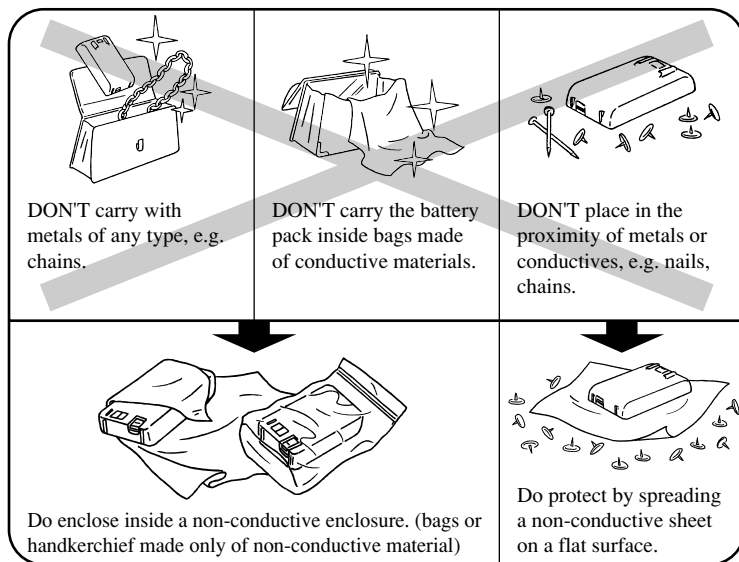

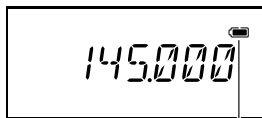

2.1.6 Battery-Level Icon

During the operation, a black battery icon indicates that the battery-level is in usable range. When it turns to empty, please charge the pack or replace the cells with new ones.



Battery-level icon

-  The battery is in usable condition.
-  Battery-level is low. Replace or charge the pack.

3. Names and Operations of Parts

3.1 Names and Operations of Keys and Ports

Top and Front

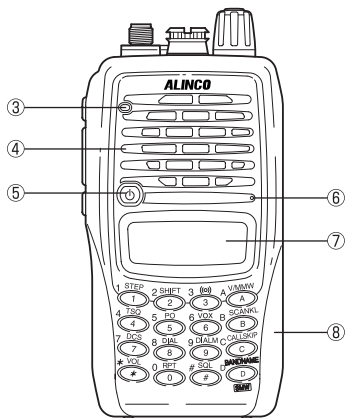
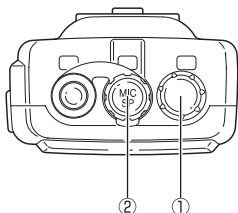

①	Dial	Rotate the dial to select the frequency of operation, memory channel, offset frequency, tone frequency, DCS code, Set mode settings, and the characters for name-tags. Rotating the dial while pressing the FUNC key increases or decreases the frequency in 1MHz order.
②	Microphone/Speaker jack	For an optional speaker/Mic connection. Securely close the cover for water-proof while the accessory isn't in use.
③	TX/RX lamp	Lights green when the squelch is unmuted. Lights red during transmission.
④	Speaker	A speaker is built in.
⑤	Power key	Press the power key down for approximately one second to turn on/off the unit.
⑥	Microphone	Speak into the microphone from a distance of about 5cm (2").
⑦	Display (LCD)	Refer to "Display" (page 22).
⑧	Keypad	Refer to "Keypad" (page 21).

Side

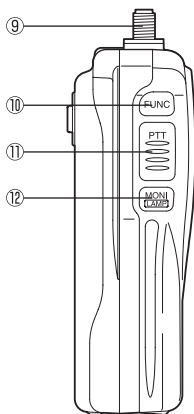

Antenna side

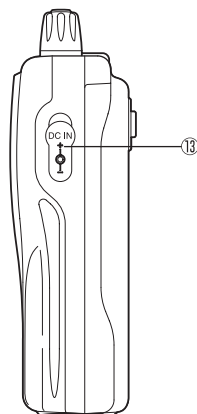

Dial side

⑨	SMA Antenna Connector	Attach the whip antenna. If you plan to use an optional antenna, select one that is tuned to the operating frequency.
⑩	FUNC key	The FUNC key is used in combination with the other keys to access the various functions of the unit. To enter the Set mode to set operating parameters, press the FUNC key continuously for about 2 seconds.
⑪	PTT key	Press the PTT key to transmit, release to receive.
⑫	MONI key	When the MONI key is pressed, the squelch unmutes regardless of the TSQ/DCS setting. Pressing the MONI key after pressing the FUNC key illuminates display for about 5 seconds. Pressing the MONI key while pressing the PTT key transmits a tone-burst signal.
⑬	DC-IN jack	Connect an external power source of DC 7.0V~DC 16.0V at 2A or more. An optional EDC-36 cigar-cable is available for mobile operation. EBP-65/66 packs can be charged using this jack (page 17).

3.2 Keypad



key	Without pressing the FUNC key.	While F appears after the FUNC key is pressed.
1 STEP ①	Inputs 1.	Channel step setting (page 26).
2 SHIFT ②	Inputs 2.	Offset frequency setting (page 27).
3 (to) ③	Inputs 3.	Alert Function (page 43).
4 TSQ ④	Inputs 4.	Tone Encode / Tone Squelch setting (page 36).
5 PO ⑤	Inputs 5.	Hi/Mid/Low power setting (page 32).
6 VOX ⑥	Inputs 6.	VOX setting (page 43).
7 DCS ⑦	Inputs 7.	DCS (digital code squelch) setting (page 37).
8 DIAL ⑧	Inputs 8.	Auto dialer operation (page 40).
9 DIALM ⑨	Inputs 9.	Auto dialer memory setting (page 40).
0 RPT ⑩	Inputs 0. Battery type setting (page 44) Reverse operation (page 27, 42)	Repeater-Access function setting (page 42).
A V/M/MW A	Switches between the VFO and Memory mode (page 24).	Memory programming (page 28).
B SCANKL B	Start/Stop scanning (page 33).	Key / Frequency lock setting (page 34).
C CALLSKIP C	Access the Call channel (page 31).	Memory channel skip setting (page 34).
D BANDNAME D (SMW)	Switches between the VHF and UHF (page 24). Quick-write memory (page 29)	Naming memory channels setting (page 35).
# SQL #	SQL adjustment (page 23).	N/A
* VOL *	Audio level adjustment (page 23).	N/A

* The numeric keys can be used for direct VFO frequency input within the product's operating range. DTMF tones are generated by pressing the keys during transmissions.

3.3 Display (LCD)

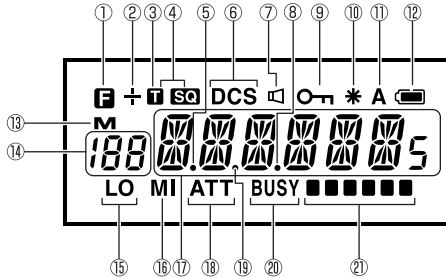



①	F	Appears when the FUNC key is pressed.
②	+	Indicates the shift (+/-) direction.
③	T	Appears when setting the CTCSS tone encoder.
④	T SQ	Appears when setting the tone squelch.
⑤	•	Appears when setting the VOX.
⑥	DCS	Appears when setting the DCS.
⑦		Appears when setting the NFM.
⑧	•	Displays the frequency and scan operation.
⑨		Displayed when the frequency or the keypad is locked.
⑩	*	Appears when the Repeater-Access function is activated.
⑪	A	Appears when Auto-Power-Off function is activated.
⑫		Indicates battery-level. The black icon flashes when the battery charge function is on.
⑬	M	Displayed when in the Memory mode.
⑭	<i>188</i>	Displays the memory channel No.
⑮	LO	Displayed when the transmission output is in LOW setting.
⑯	MI	Displayed when the transmission output is in MID setting.
⑰		Displays the operating frequencies, name-tags and parameters in the setting mode.
⑱	ATT	Appears when the attenuator is activated.
⑲	•	Appears when setting the channel skip.
⑳	BUSY	Appears when the squelch is unmuted.
㉑		Indicates the receiving signal (S-meter) and transmission output levels (Power-meter).

3

4. Basic Operation

4.1 Turning On the Power

Hold the  key down for a second.

To turn off the power, hold the  key down until the display turns off.



4.2 Adjusting the Audio Output (Volume)

- There are 31 audio output levels (00~30).
- The default setting is level 15. There is no audio output at this status.

1. Press the  key. The level is displayed on the LCD.

2. Rotate the dial to increase or decrease the level.
As the setting value increases, the audio becomes louder.



3. Press any key except for the MONI key or just leave it for 5 seconds to automatically complete the setting.

4.3 Adjusting the Squelch

Squelch is a function that eliminates the noise when no signals are being received.

- There are 10 squelch levels (00~10).
- The default setting is level 03.

1. Press the  key. The squelch level is displayed on the LCD.

2. Rotate the dial to increase or decrease the squelch level. Set to the lowest level that the noise is cut.



3. Press any key except for the MONI key or just leave it for 5 seconds to automatically complete the setting.

4.4 Operating Modes

This DJ-V57 has three operating modes: VFO mode, Memory mode and CALL mode. The VFO mode allows to operate at the displayed frequency. The Memory mode has 200 channels (VHF/UHF mixture) and the CALL mode has one VHF and one UHF channel.

Switching Between Modes

“VFO mode” and “Memory mode” are switched by pressing the $\overset{A}{\text{V/MMW}}$ $\text{\textcircled{A}}$ key

M appears on the display when “Memory mode” is activated, and disappears when “VFO mode” is activated.

“CALL mode” is activated by pressing the $\overset{C}{\text{CALLSKIP}}$ $\text{\textcircled{C}}$ key. $\text{\textcircled{C}}$ appears on the display. To return to the previous mode, press the $\overset{C}{\text{CALLSKIP}}$ $\text{\textcircled{C}}$ key again. To switch between VFO VHF and VFO UHF, or CALL VHF/UHF, press the “BAND” key while in either of those modes.

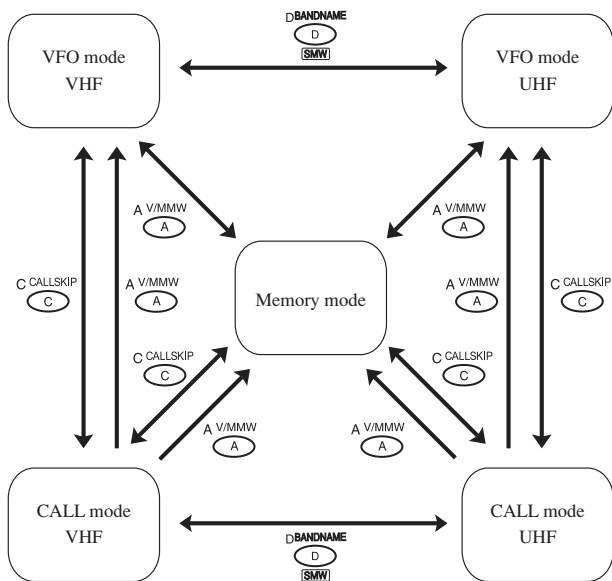

4.5 Setting the Frequency in the VFO Mode

The factory default of this unit is the VFO mode. The VFO mode allows you to change the frequency and operating parameters by using the dial and key operations.

4.5.1 Setting the Frequency

To Select the VFO Mode

The $\overset{A}{\text{VMMW}}$ $\text{\textcircled{A}}$ key switches between the VFO and Memory mode each time the key is pressed.

"**M**" is displayed on the LCD when the unit is in the Memory mode.

Selecting the Operating Frequency

Rotate the dial clockwise to increase the frequency by one tuning step.

Rotate the dial counter-clockwise to decrease it by one tuning step.

To Quickly Change the Frequency

Press the FUNC key, and while **F** is displayed on the screen, rotate the dial to increase or decrease (depending on the direction of rotation) the frequency by 1MHz order.

Entry from the Keypad

Use the numeric keys to set the frequency. It accepts valid numbers only.

ie: 145.210 MHz

1. Input the 100MHz digit by pressing $\overset{1 \text{ STEP}}{\text{\textcircled{1}}}$
2. Input the 10MHz digit by pressing $\overset{4 \text{ TSQ}}{\text{\textcircled{4}}}$
3. Input the 1MHz digit by pressing $\overset{5 \text{ PO}}{\text{\textcircled{5}}}$
4. Input the 100kHz digit by pressing $\overset{2 \text{ SHIFT}}{\text{\textcircled{2}}}$
5. Input the 10kHz digit by pressing $\overset{1 \text{ STEP}}{\text{\textcircled{1}}}$

Depending on the tuning step, entry may be required to the 1kHz digit.

The relationship between the tuning step and entry-completion digit is shown in the following chart. The setting will be completed automatically when the last digit is correctly entered and a high-tone beep sounds.

4.5.3 Shift Direction and Offset Frequency Settings

In conventional repeater systems, a signal received on one frequency is retransmitted on another frequency. The difference between these two frequencies is called the offset frequency. The selectable offset frequency of this unit is from 0 to 99.995MHz.

1. Press the FUNC key, and while **F** is displayed, press the $\overset{2}{\text{SHIFT}} \overset{2}{\text{2}}$ key to display the current offset frequency and shift direction settings.
2. Each time the $\overset{2}{\text{SHIFT}} \overset{2}{\text{2}}$ key is pressed the shift direction changes as indicated below.
A (-) means that the TX frequency is lower than the RX frequency.
A (+) means vice versa.

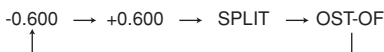

3. Rotate the dial while the shift frequency is being displayed.
Clockwise: each click increases the frequency by one tuning step.
Counter-clockwise: each click decreases the frequency by one tuning step.
Press the FUNC key and rotate the dial to increase or decrease the frequency in 1MHz steps.
4. Press any key except for the MONI or FUNC key to complete setting.

Reverse operation is possible by pressing the $\overset{0}{\text{RPT}} \overset{0}{\text{0}}$ key.

The repeater function releases temporary and you can transmit on the frequency originally used for the repeater downlink while monitoring the uplink frequency.

Press $\overset{0}{\text{RPT}} \overset{0}{\text{0}}$ again to go back to the normal repeater mode.

The shift-direction icon flashes during the reverse operation.

SPLIT

This function changes the transmission band in relation to the receiving band.

The transceiver receives the currently displayed VFO frequency, and transmits on the VFO frequency of another band.

NOTE:

- Please refer to "Selective Calling" (page 36) to set the CTCSS/DCS tones usually required for conventional Repeater-Accesses.
- SPLIT function can't be used in the Memory mode and Call-Channel mode.

4.6 Memory Mode

This mode allows recalling and operating the preprogrammed frequency or setting in the memory channels. This unit provides up to 200 memory channels, 2 CALL channel (VHF/UHF), 2 Repeater-Access function memory (VHF/UHF), 10 Transmitter Detecting Function memory and 2 Program scan edge memory (VHF/UHF).

4.6.1 How to Program Memory Channel(s)

1. Select a frequency and operating parameters to be programmed in the VFO mode. Programmable parameters are explained later. Press the $\overset{A}{\text{VMMW}}$ key. "M" appears on the display.
2. Press the FUNC key to display **F**.
3. Rotate the dial to select the desired memory channel number while **F** is displayed. An empty channel is shown with a flashing "M". "V-SET (U-SET)" is explained later.
4. By pressing the $\overset{A}{\text{VMMW}}$ key again while **F** is on the display, a beep sounds and programming is completed.
5. Pressing the FUNC then $\overset{A}{\text{VMMW}}$ key while **F** is displayed on the programmed channel will delete the memory data and it becomes available for reprogramming.

4.6.2 Recalling a Memory Channel

1. Select the Memory mode by pressing the $\overset{A}{\text{VMMW}}$ key. "M" and channel number appear on the display to indicate that the unit is in the Memory mode. Repeat to switch between the Memory and VFO modes.
2. Select a memory channel.
Rotating the dial will increase or decrease a memory channel number.

4.6.3 Deleting a Memory Channel

1. Select the Memory mode by pressing the $\overset{A}{\text{VMMW}}$ key.
2. Rotate the dial to select the memory channel No. that you wish to delete.
3. Press the FUNC key, and while **F** is displayed on the LCD, press the $\overset{A}{\text{VMMW}}$ key. A beep sounds, then "M" flashes on the display.

NOTE:

- Over writing new data is always permitted. It's not necessary to delete the old data before overwriting.
- When "M" is flashing in step 3 (when the memory contents are displayed as is on the display), it is still possible to cancel the operation by pressing the FUNC key, and while **F** is displayed on the LCD, press the $\overset{A}{\text{VMMW}}$ key. After changing channels or modes, this is no longer possible.

4.6.4 Quick Program Memory Channel(s)

This function is to quickly write in the memory.



1. Select a frequency and operating parameters to be programmed in the VFO mode.
2. Press the  key for more than 2 seconds.
3. The memory number blinks and a beep sounds.

NOTE:

This function can't be used if all memory channels are already programmed.

4.6.5 Transmitter Detecting Function

This is a function that receives a particular frequency and indicates the relative distance to the transmitter by the strength of the detected signal. As the transmitted signal gets stronger, a beep will sound in shorter intervals (the sound heard correlates to S-meter signal strength). Use this function for fox hunting.

1. Select a frequency and operating parameters to be programmed in the VFO mode. Programmable parameters are explained later. Press the  key. "M" appears on the display.
2. Press the FUNC key to display **F**.
3. Rotate the dial to select the memory channel number d0 ~ d9.
4. By pressing the  key again while **F** is on the display, a beep sounds and programming is completed.
5. Pressing the FUNC then  key while **F** is displayed on the programmed channel will delete the memory data and it becomes available for reprogramming.
6. To exit from this function, move any normal memory channel or select VFO mode.
7. To activate this function, select d0 ~ d9 channels in the memory mode.

When using this function, received signals can't be heard.



When this function is selected, the detecting tone will automatically start to sound. However, When the tone squelch and/or the DCS are set, the detecting tone will sound only when the tone squelch frequency or DCS codes correspond.

- When the transmitter is at close range or when the transmitter signal is strong, use the Attenuator function.
- You can hear the received signal by pressing the MONI key (the receive indicator will light at this time). When a microphone is attached to the transmitter, you can hear sounds around the transmitter by pressing the MONI key.

4.6.6 Programming a Repeater-Access Function Setting

The "Repeater-Access" function is to set the desired shift and tone parameters to the current operating frequency by just 2 key-touches.

Please set the parameters to be applied to the Repeater-Access function here.

1. Enter the Memory mode (by pressing the  key if necessary).
2. Rotate the dial to select MrpV-SET (VHF band) or MrpU-SET (UHF band).
3. Set the most commonly used Repeater-Access parameters by referring to "Repeater-Access" (page 42). The parameters can be programmed in this memory are marked * in the chart below. By activating the Repeater-Access function these settings are applied to the operating frequency regardless of the VFO/Memory/CALL modes, by temporary replacing the current parameters.
4. After programming is completed, press the FUNC key then press the  key while MrpV(U)-SET is displayed to store the edited parameters.
5. Rotate the dial to operate in the Memory mode by selecting channels or press the  key for VFO mode operation.
6. To operate with repeater-access, please refer page 42.

NOTE:

- You can not communicate in the MrpV(U)-SET setting channel.
- The MrpV(U)-SET channel is skipped during scanning. You can not delete or convert this memory to other purposes.

4.6.7 Programmable Parameters in Memory Channels

The following parameters can be stored in each of the memory channels.

- | | |
|-------------------------------|--|
| • Frequency | • Offset frequency * |
| • Skip channel setting | • Shift direction (+/-) * |
| • Busy channel lockout (BCLO) | • Tone encoder frequency * |
| • Transmission power (H/M/L) | • Tone decoder frequency * |
| • Battery save setting | • Tone encoder/decoder setting (TSQ) * |
| • Clock Shift setting | • DCS code * |
| • Alphanumeric channel tag | • DCS setting * |
| • ATT Level | • WFM/NFM setting |

NOTE:

Only parameters marked "*" are programmable in Repeater-Access function memory.

4.7 Call-Channel Mode

This mode is used to recall a most frequently used memory channel (stored in MC channel) with a single key-touch.

1. Press the ^{C CALLSKIP}_C key.
"☐" is displayed on the LCD, and the channel programmed in MC is recalled.
2. Press the ^{C CALLSKIP}_C key again or the ^{A VMMW}_A key in the Call mode to return to original operating mode (VFO/memory).



How to Program Call-Channel Mode

1. Select the Memory mode by pressing the ^{A VMMW}_A key.
2. Rotate the dial to select the MC channel.
3. Select the VFO mode by pressing the ^{A VMMW}_A key.
4. Press the FUNC key to display **F** and MC.
5. By pressing the ^{A VMMW}_A key again while **F** is on the display, a beep sounds and programming is completed.

IMPORTANT NOTE:

- The dial and direct key-entry of frequency/memory channel are blocked in the Call mode.
- It is possible to temporary change the offset and CTCSS/DCS related parameters in the Call mode.
- The Scan function is deactivated in the Call mode.
- The CALL channel reprogramming is possible but it can't be deleted from the memory channel mode.

4.8 Receiving

1. Turn on the unit.
2. Press the ^{* VOL}_{*} key and rotate the dial to adjust the audio level as necessary.
3. Press the ^{# SQL}_# key and rotate the dial to adjust the squelch level.
4. Select the frequency that you wish to operate by using the dial or the keypad.
When a signal is received on the frequency that you selected, **BUSY** and S-meter are displayed on the LCD, then the received signal can be heard. The green RX indicator also lights at this time.

4.8.1 Monitor Function

In case the receiving signal is weak and the audio is intermittently cut off by the squelch, press the MONI key. As long as this key is pressed, the squelch including TSQ/DCS unmutes making the audio easier to hear.

- The squelch is unmuted while the MONI key is pressed, regardless of the squelch level setting.
- This function unmutes the squelch even if the DCS and Tone Squelch functions are set.

4.9 Transmitting

1. Select the frequency by using the dial or keypad.
2. Press the PTT key.
The red TX indicator turns on while transmitting.
3. While holding down the PTT key, speak into the unit at normal voice from the distance of 5cm (2").
4. Release the PTT key to receive.

IMPORTANT NOTE:

- To transmit a tone-burst signal, press the MONI key while holding down the PTT key.
- Speaking too loud, too close or too far from the unit may distort the audio.
- "OFF" appears on the display and a beep sounds when the PTT key is pressed with the TX frequency set out of the TX range. You can not transmit in this state.
- The communication distance changes by the environment.

4.9.1 Selecting the Output Level

Press the FUNC key, and while **F** is displayed on the LCD, press the $\overset{5}{\text{PO}}$ key to switch transmission power output.

Every time you repeat this operation, the display changes as follows depending on the output level selected:

- **LO** is displayed with ■ ■ on the power meter. (Low power output)
- **MI** is displayed with ■ ■ ■ ■ on the power meter. (Middle power output)
- Nothing is displayed with ■ ■ ■ ■ ■ ■ on the power meter. (High power output)

The initial setting is low power.

IMPORTANT NOTE:

The output level can't be altered while transmitting.

5. Useful Functions

5.1 Scan Modes

The scan function automatically searches the receiving signals. There are 2 modes for scan-resume condition.

- Busy Scan: The scan stops when a signal is detected, stays until the signal is gone then resumes scanning.
- Timer Scan: The scan stops when a signal is detected, and resumes scanning after 5 seconds regardless of receiving status (TIMER1 setting).

During scanning, the 1MHz decimal point (•) on the frequency display flashes.

Press any key other than the MONI key to stop scanning.

Scanning starts in the direction of the last dial operation (up or down).

NOTE:

Please refer to the Set mode to switch the setting between Timer and Busy scan modes (page 46).

5

5.1.1 VFO-Scan

1. Use the $\overset{A}{VMMW}$
 $\underset{A}{A}$ key to select the VFO mode.
2. Press the $\overset{B}{SCANL}$
 $\underset{B}{B}$ key to start scanning. The unit scans in accordance with the order of one step.
3. Rotate the dial clockwise/counter-clockwise to change the scan direction.
VFO-scan scans the entire frequency range.
4. Press any key other than the MONI key to stop scanning.

5.1.2 Memory-Scan

1. Use the $\overset{A}{VMMW}$
 $\underset{A}{A}$ key to select the Memory mode.
2. Press the $\overset{B}{SCANL}$
 $\underset{B}{B}$ key to start memory scanning.
3. Rotate the dial clockwise/counter-clockwise to change the scan direction.
Memory-scan scans all programmed memory channels.
4. Press any key other than the MONI key to stop scanning.

NOTE:

Please set the squelch level correctly before scanning, even in the TSQ scanning the normal squelch level adjustment is required to activate this function.

5.1.3 Setting Skip Channels

You can select the memory channels that you wish to skip during the memory-scan.

- Press the FUNC key in the Memory mode, and while **F** is displayed, press the  key to set the currently selected memory channel as a skip channel. Use the same procedure to clear the skip channel setting.
- The 10MHz decimal point appears for memory channels that are set as skip channels.

NOTE:

The Call channel and Repeater-Access memory are automatically skipped during scanning.

5.2 Keylock

Press the FUNC key, and while **F** is displayed, press the  key to set the Keylock function on, and repeat the same to quit.

When the Keylock is on, the  is displayed on the LCD.

When the Keylock is on, other than the following, all operations are blocked.

- * PTT
- * LAMP
- * MONI
- * VOL
- * SQL
- * Tone-burst
- * POWER ON/OFF
- * DTMF tone
- * VOX sensitivity

NOTE:

Keylock function can't be activated on the Repeater-Access function memory setting channel.

5.3 Tone-Burst





This function is to generate an audible tone to access European repeaters.

- To output the tone-burst tone, press the MONI key while holding down the PTT key. The tone is transmitted as long as the MONI key is pressed. The initial setting for the tone-burst tone is 1750Hz, but this can be changed in the Set mode (page 49).
- While transmitting the tone-burst tone, the CTCSS/DCS tone is temporary suspended.
- The transmitting tone can't be monitored.

5.4 Naming Memory Channels

In the Memory mode, it is possible to display up to 7 alphanumeric characters (Name-tag) instead of conventional frequency display.

5.4.1 Setting Name-Tag

1. Select the memory channel.
2. Press the FUNC key, and while **F** is displayed press the  key.
3. [A] flashes on the display.
4. Rotate the dial to select a character to be the first digit.
5. Press the  key to input the next character. The previous character will stop flashing.
6. Repeat the same sequence as necessary.
Press the  key during setting to delete all characters.
7. Press any key (except MONI, , ) to complete the setting.

5.4.2 Using the Channel Name Function

- Programmed memory channels are displayed with alphanumeric characters. The channel number is displayed as it normally is.
- Press the FUNC key to display the frequency display for 5 seconds. Pressing certain keys during this 5 sec period may immediately recall the alphanumeric display, while other keys access their allocated functions.

5.5 Lamp

Press the FUNC key, and while **F** is displayed on the LCD, press the MONI key to illuminate the display and DTMF keypad.

- The backlight automatically switches off if there is no key operation for 5 seconds.
- Pressing any key other than the LAMP key extends the LAMP function for another 5 seconds.
- Turning on the power while pressing the MONI key illuminates the backlight permanently. Repeat the same to turn it off.
- When the lamp is set for the "permanent-on" position, pressing the FUNC key then the MONI key to turn on/off the backlight.

NOTE:

The LAMP function consumes battery. The "permanent-on" position is recommended only for the operation using an external power source.

6. Selective Calling

Selective Calling Operations

- To communicate only with selected stations, use either the Tone Squelch or the DCS function.
- The Tone Squelch function unmutes the squelch only when a signal added with one of the matching 39 CTCSS tone frequencies is received.
- The DCS function unmutes the squelch only when a signal added with one of matching 104 digital codes is received.
- It isn't possible to use the Tone Squelch and DCS functions at the same time.

6.1 Tone Squelch (TSQ)

6.1.1 Setting the Tone Squelch

1. Press the FUNC key, and while **F** is displayed on the LCD, press the **4^{TSQ}** key to display the current TSQ settings. Each time the **4^{TSQ}** key is pressed, the display shows:

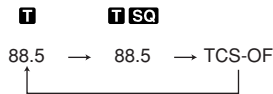

- When only **T** is displayed, the unit encodes the CTCSS tone.
 - When **T SQ** is displayed, the unit encodes and decodes the CTCSS tone.
2. Rotate the dial while the tone frequency is displayed to select one of the 39 CTCSS tones shown below. The tone can be set for encode/decode separately (refer to page 37 for details).

(unit: Hz)									
67.0	69.3	71.9	74.4	77.0	79.7	82.5	85.4	88.5	91.5
94.8	97.4	100.0	103.5	107.2	110.9	114.8	118.8	123.0	127.3
131.8	136.5	141.3	146.2	151.4	156.7	162.2	167.9	173.8	179.9
186.2	192.8	203.5	210.7	218.1	225.7	233.6	241.8	250.3	

3. Press any key other than the MONI key to complete the setting. Observe that both **T** and **SQ** are displayed.

6.1.2 Switching Off the Tone Squelch

Press the ⁴TSQ key in Tone Squelch Setting mode to select TCS-OFF, then press any key other than the MONI key to complete the setting.

6.1.3 To Differentiate the ENC/EDC Tones

It is possible to set the encode and decode tones independently in the Tone Squelch Setting mode.

- To set the encode tone, when **T** displayed, select a desired tone. The decode tone is set automatically to the same tone.
- To differentiate the decode tone, select another tone in **T SQ** status.

6.1.4 Tone Squelch Operation

The squelch unmutes only when the signal with the same decoding-setting tone is received.

6.2 DCS

6.2.1 Setting the DCS

1. Press the FUNC key, and while **F** is displayed on the LCD, press the ⁷DCS key. "DCS" is displayed on the LCD, and the DCS code is displayed. The initial setting is 023.

Each time you press the ⁷DCS key, the display switches between:

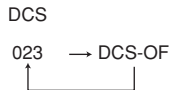

2. Press any key other than the MONI key to complete the setting. Observe that "DCS" is displayed.

6.2.2 Changing the DCS Code

1. Rotate the dial in DCS Code Setting mode (while "DCS" is displayed).
2. Press any key other than the MONI key to complete the setting.
 - The same DCS code is set for ENC/DEC, differential setting isn't available.

One of the following 104 DCS codes can be selected.

023	025	026	031	032	036	043	047	051	053
054	065	071	072	073	074	114	115	116	122
125	131	132	134	143	145	152	155	156	162
165	172	174	205	212	223	225	226	243	244
245	246	251	252	255	261	263	265	266	271
274	306	311	315	325	331	332	343	346	351
356	364	365	371	411	412	413	423	431	432
445	446	452	454	455	462	464	465	466	503
506	516	523	526	532	546	565	606	612	624
627	631	632	654	662	664	703	712	723	731
732	734	743	754						

6.2.3 Switching Off DCS

Select DCS-OFF in the DCS Code Setting mode to turn it off.

6.2.4 DCS Operation

The squelch unmutes only when the unit receives the matching code.

6.2.5 DET Mode in DCS Operation

DET Setting

If the DET mode in DCS operation is preferred, while in the DCS Code Setting mode and DCS-OFF is displayed, rotate the dial to eliminate the hyphen (DCS OF) then proceed with the rest of setting sequence.

DET on DCS function stands for Detect-Only mode. In DCS operation, the TX signal carries a digital code. The RX side, just like TSQ, detects this tone stream and determines the squelch operation. This DCS code stream is transmitted all the way through the communication like a CTCSS tone and it is necessary for receiver to correctly and CONTINUOUSLY receive this DCS stream to hold the squelch open, otherwise the CPU thinks that the signal is unwanted and it closes the squelch. But due to noise or weak signal strength etc, sometimes it is difficult to continuously receive a DCS stream. By activating DET, the receiver opens the squelch when the first corresponding DCS stream is received, then thereafter, regardless of the status of the DCS codes, the DCS squelch remains opened.

Advantage of DET

It enables DCS squelch operation even in poorer signal conditions.

Disadvantage of DET

When it is activated, suppose 2 stations are sharing the same channel and using the DCS selective-calling technique and transmitting at the same time. After station A with its corresponding DCS is gone, you may still hear station B even his DCS code is different from A, although he can't open your DCS squelch by his signal alone.

6.3 DTMF Tone Encoding

To Manually Transmit DTMF Tones

1. Press the numeric, alphabetic or symbol keys while holding down the PTT key. The tones sound as long as the key is pressed.
2. Up to 16 characters of manually transmitted DTMF tones are automatically stored for redialing. Refer to "Redial" (page 41) for operation.

6.4 Auto Dialer

The DTMF tones can be stored in the memory to automatically transmit.

6.4.1 Setting the Auto Dialer

- All 16 DTMF tones up to 16 characters are available for each of 9 memories and "Mst" memory called an Auto Dialer memory.

Programming the Auto Dialer Memories

1. Press the FUNC key, and while **F** is displayed on the LCD, press the $\overset{9 \text{ DIALM}}{\text{9}}$ key to enter the Dialer Setting mode. The "M1" appears.
There are six space available for characters on the display, and nothing is displayed initially.
2. Select a desired Auto Dialer memory channel from M1 to M9 and Mst by rotating the dial.
 - The "Mst" memory is explained on page 51 "STB-DT"
3. Use the DTMF key to input the DTMF tones.

For example: when programming 123456789, the display changes as follows:

[1]->[12]->[123]->[1234]->[12345]->[123456]->[234567]->[345678]->[456789]

- To set a pause instead of a tone, press the FUNC key, and while **F** is displayed, press the $\overset{0 \text{ RPT}}{\text{0}}$ key. "-" is displayed for a pause.
The pausing time is approx. 1 second.
 - Press the FUNC key, and while **F** is displayed, rotate the dial to scroll the display to see the hidden characters.
 - To clear the programming, press the FUNC key, and while **F** is displayed, press the $\overset{C \text{ CALLSP}}{\text{C}}$ key.
4. Press the PTT key to complete the programming.

6.4.2 Generating the Auto Dialer Codes

Please program the Auto Dialer memory channel(s) in advance.

1. Press the FUNC key, and press the $\overset{8 \text{ DIAL}}{\text{8}}$ key. "DIAL" is displayed on the LCD.
2. Press one of the $\overset{1 \text{ STEP}}{\text{1}}$ to $\overset{9 \text{ DIALM}}{\text{9}}$ key (corresponding to memory #1~#9) to automatically generate the DTMF tones.

Auto Dialer Operation While Transmitting

1. While pressing the PTT key, press the FUNC key. "DIAL" is displayed on the LCD. Don't release the PTT to proceed.
2. Press one of the $\overset{1 \text{ STEP}}{\text{1}}$ to $\overset{9 \text{ DIALM}}{\text{9}}$ or $\overset{A \text{ VMMW}}{\text{A}}$ key to automatically transmit the DTMF tones stored in memories.

6.4.3 Redial (While Receiving)

This function generates the last DTMF tones used by the unit.

1. Press the FUNC key, and while **F** is displayed on the LCD, press the $\overset{8}{\text{DIAL}}$
 $\underset{8}{\text{8}}$ key.
2. Press the $\overset{0}{\text{RPT}}$
 $\underset{0}{\text{0}}$ key. The last DTMF tones (either the auto dialer code or a manually input DTMF code) is automatically generated from the speaker. The unit doesn't transmit the tones in this operation.
3. To transmit, press the FUNC key while pressing the PTT key, then the $\overset{0}{\text{RPT}}$
 $\underset{0}{\text{0}}$ key.

Please note that you must operate the DTMF tones at least once to proceed above.

7. Special Functions

7.1 Repeater-Access

1. In the VFO/Memory/Call channel mode, select the channel to which you wish to apply the Repeater-Access setting.
2. Press the FUNC key, and while **F** is displayed on the LCD, press the $\overset{0}{\text{RPT}}$ key.
The Repeater-Access setting is applied to the operating frequency.

NOTE:

Preset parameters on the Repeater-Access function memory will be effective at any frequency. Repeater-Access parameters have priorities over the parameters programmed in the VFO/memory/CALL modes.

Reverse operation is possible by pressing the $\overset{0}{\text{RPT}}$ key.

The repeater function releases temporary and you can transmit on the frequency originally used for the repeater downlink while monitoring the uplink frequency.

Press $\overset{0}{\text{RPT}}$ again to go back to the normal repeater mode.

The * icon flashes during the reverse operation.

7.2 Program Scan

This is a type of VFO scan, but by setting the frequency range of the VFO into PH and PL channels, it only scans between those frequencies.

With setting the PH and PL properly, up to 3 Program scan ranges will be available.

1. Enter the Memory mode and set the PL and PH frequency into the designated memory channels. Refer to Memory setting for the proper sequence.
2. Return to VFO mode by pressing $\overset{A}{\text{VMMW}}$ key. Set the VFO to the frequency within the range to be program-scanned.
3. Press the $\overset{B}{\text{SCANKL}}$ key to start scanning. During this scan mode, "P" flashes after memory channel display.
4. Press any key other than the MONI key to stop scanning.

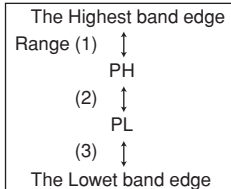

7.3 VOX

This function allows to transmit without using the PTT by simply speaking into the microphone. When you have stopped speaking, the unit will return to receive.

1. Press the FUNC key and while **F** is displayed on the LCD, press the $\overset{6}{\text{VOX}}$ key to display the VOX setting.
2. Rotate the dial to select the using microphone.

VO-OFF → VO-IN → VO-OUT

VO-OFF : VOX function OFF
 VO-IN : Internal mic
 VO-OUT : Option mic

3. Adjust the VOX sensitivity level. Press the $\overset{6}{\text{VOX}}$ key.
4. Rotate the dial and adjust for the volume of your voice when transmitting. The VOX sensitivity can be set from 1 (low) to 7 (high). When the VOX sensitivity is set to 0, the VOX function is disabled.
5. Press any key other than the MONI key, PTT key and $\overset{6}{\text{VOX}}$ key to finish setting.

NOTE:

- When the sensitivity is raised too high, there may be cases when quieter voices and/or nearby sounds are unintentionally transmitted.
- When the VOX is active, you can't transmit using the PTT key.
- Even when the sensitivity is properly adjusted, there may be cases when the radio transmits when there are loud sounds nearby.
- When the VOX feature is active, you can't transmit tone calls, DTMF or auto-dials.
- During VOX, the 100MHz decimal point (●) on the frequency display flashes.

7.4 ALERT

1. Press the FUNC key and while **F** is displayed on the LCD, press the $\overset{3}{\text{(M)}}$ key.
2. Alert signal is transmitted for 5 seconds, and the sound is emitted from the speaker.
3. The alarm stops if any key is pressed.
 - An alarm-tone feature is useful to attract monitoring stations attentions.

7.5 Battery Type Setting

Select the correct battery type from Ni-MH battery pack, Li-ion battery pack and Alkaline dry cells in order to display the battery-level icon correctly and to perform the battery-charge using the DC-jack.

1. Press the O RPT key for more than 2 seconds.
2. Rotate the dial to select battery type.
 - BAT-NI : Ni-MH battery pack (But doesn't charge from DC-Jack)
 - BAT-LI : Li-ion battery pack
 - BAT-AL : Alkaline dry cells
 - BAT-N+ : Charging the Ni-MH Battery Pack from DC-Jack.

NOTE:

- Please be sure to select BAT-AL when using a dry cell case otherwise it may risk a leak of battery liquid, heat or explosion of the battery cells and the battery case.

7.6 Battery Refresh

Repeating improper recharge of the Ni-MH battery pack may cause so-called the "memory effect" that the battery holds less charge. To avoid this, it is recommended to fully discharge the battery pack then full charge. This function helps discharging the battery pack. Please remove the unit from a charger or a DC cable before this operation.

1. Activate the Keylock (page 34).
2. Press the A VMMW key twice, the B SCANKL key twice, the C CALLSP key twice and then the D BANDNAME key twice. "DISCHG" will be displayed on the LCD, and the battery-refresh starts.



DISCHG

3. To cancel this operation, just turn off the unit, turn it on again.
4. The unit will turn off automatically when finished the refresh.

8. Set Mode

The Set mode is used to customize the various operational parameters of your DJ-V57.

8.1 Set Mode Operation

This chart shows the available parameters in the Set mode.

Menu	Default setting	Function
01	BS-1	Battery save
02	TIMER1	Scan setting
03	BEP-ON	Beep sound
04	VOD-OFF	VOX delay time setting
05	APO-OFF	Auto power off
06	NORMAL	FM/NFM setting
07	ATT-OFF	Attenuator setting
08	SFT-OFF	CPU clock frequency shift
09	BCL-OFF	Busy channel lock out
10	1750	Tone burst frequency
11	T-OFF	Time out timer setting
12	TP-OFF	TOT penalty setting
13	DWT-01	DTMF wait time setting
14	DF-60	DTMF first digit burst time setting
15	DB-60	DTMF burst time setting
16	DP-60	DTMF pause time setting
17	STB-OFF	Stand by beep
18	MID-05	MID power setting

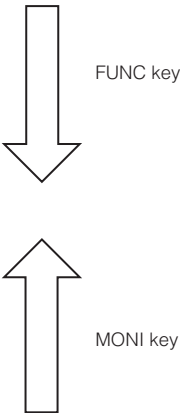

8.2 Entering the Set Mode

1. Press the FUNC key for at least 2 seconds.
The unit enters the Set mode.
"BS-1" is displayed as a factory-default.
2. Press the MONI key or FUNC key to select a menu.
The Monitor function can't be used in this status.
3. Rotate the dial to change the parameter.
4. Press any key other than the MONI key and FUNC key to complete the settings.

The last operated menu will be selected the next time you enter the Set mode.

8.3.5 Menu 5 Auto-Power-Off Setting

This function prevents the batteries from being exhausted when you forget to switch off the power.

1. APO-OF is displayed on the LCD.
2. The auto power off setting will change between ON and OFF when the dial is turned.
3. When the setting is set to ON, **A** is displayed on the LCD.

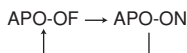

APO Operation

After having activated the APO and about 30 minutes elapse without any key-operation, the unit turns off automatically alerting with a beep sound. The time to Auto-Power-Off is determined by the last key operation only, not the last signal received.

8.3.6 Menu 6 FM / NFM Setting

Use this function to select the deviation width of FM.

1. NORMAL is displayed on the LCD.
2. Rotate the dial to select the deviation setting between NORMAL (FM) and NARROW (NFM).
3. When the setting is NARROW,  is displayed on the LCD.

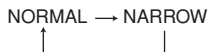

Max. deviation
• FM : $\pm 5\text{kHz}$
• Narrow FM : $\pm 2.5\text{kHz}$

8.3.7 Menu 7 ATT (Attenuator) Setting

Use this function when the receiving signal is interfered by strong signals of nearby channels. When you activate this function, the transceiver attenuates the receiving sensitivity.

1. ATT-OF is displayed on the LCD.
2. Rotate the dial to change the ATT level. There are 2 levels; ATT-1 attenuates the received signal by 10dB and ATT-2 does 20dB.

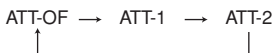

3. When the setting is set to ATT-1 or ATT-2, **ATT** is displayed on the LCD.
 - Activate this function only when you have a trouble caused by strong signal.

8.3.8 Menu 8 Clock Shift Setting

In the unlikely event that you may hear a weak noise always on the same frequency, it may be so-called a CPU-clock noise. Unfortunately this is due to the circuit-design of this product and can't be eliminated, but can be moved away to another frequency.

1. SFT-OF is displayed on the LCD.
2. Rotate the dial to select the clock shift setting on and off.

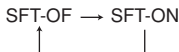

NOTE:

This function isn't a noise-blanker. Also, since not all noises are due to a CPU-clock noise, the clock shift setting may not be effective.

8.3.9 Menu 9 Busy Channel Lockout Setting

This function restricts the PTT (transmit) operation.

1. BCL-OF is displayed on the LCD.
2. Rotate the dial to select the Busy Channel Lockout setting on and off.

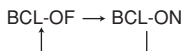

When Busy Channel Lockout is set to on, transmission is possible only in the following conditions (and isn't possible otherwise).

The alarm sounds if the PTT key is pressed when transmission is prohibited.

- 1) When no signal is being received (BUSY isn't displayed).
- 2) When the tone matches and the squelch is unmuted based on the Tone Squelch setting conditions.
- 3) When the codes match and the squelch is unmuted based on the DCS setting conditions.

8.3.10 Menu 10 Tone-Burst Frequency Setting

1. 1750 is displayed on the LCD.
2. Rotate the dial to select the tone-burst frequency.



8.3.11 Menu 11 Time Out Timer (TOT) Setting

This function stops the transmission automatically when the continuous transmission time exceeds the set time.

1. T-OFF is displayed on the LCD.
2. Rotate the dial to change the TOT time.

TOT time can be set to a maximum of 450 sec.

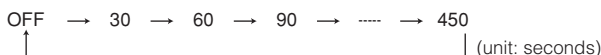

8.3.12 Menu 12 TOT Penalty Time

This parameter determines the time to resume the transmission after the unit is forced to quit transmitting by TOT.

1. TP-OFF is displayed on the LCD.
2. Rotate the dial to change the TOT Penalty Time setting.

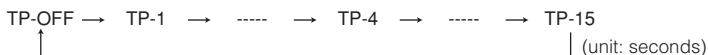

Transmission is prohibited until the penalty time elapses.

- An alert beep sounds when the PTT key is pressed during the penalty time.

NOTE:

The following 4 menus explain the Auto Dialer DTMF tone parameters. Please refer to the chart at the end for details.

8.3.13 Menu 13 DTMF WAIT Time

Use this parameter to delay the time to start transmitting the DTMF tones in Auto Dialer operation. The initial setting is 100ms.

1. DWT-01 is displayed on the LCD.
2. Rotate the dial to change the DTMF wait time setting.

DWT-01 → ----- → DWT-05 → ----- → DWT-10
 ↑ _____ (unit: 100ms)

8.3.14 Menu 14 DTMF First Digit Burst Time

It often happens that the radios fail to receive the very beginning instant of each communication due to squelch/TSQ/DCS etc. By setting the burst time of the first digit longer, the risk to miss the first DTMF tone will decrease.

1. DB-60 is displayed on the LCD.
2. Rotate the dial to select the initial-character burst time.

DF-20 → ----- → DF-100 → ----- → DF-200
 ↑ _____ (unit: ms)

8.3.15 Menu 15 DTMF Burst Time

This parameter determines the length of DTMF tones.

1. DP-60 is displayed on the LCD.
2. Rotate the dial to change the DTMF burst time setting.

DB-20 → ----- → DB-100 → ----- → DB-200
 ↑ _____ (unit: ms)

8.3.16 Menu 16 DTMF Pause Time

This parameter determines the length of pause time between the tones.

1. DP-60 is displayed on the LCD.
2. Rotate the dial to change the DTMF pause time setting.

DP-20 → ----- → DP-100 → ----- → DP-200
 ↑ _____ (unit: ms)

The DTMF Timing Chart

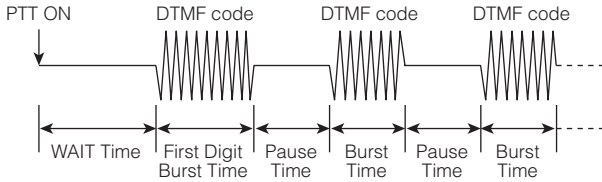

8.3.17 Menu17 Stand-by Beep/DTMF Setting

By activating this function, a short beep or DTMF tone code sounds to indicate that your transmission is end.

1. STB-OF is displayed on the LCD.
2. Rotate the dial to switch the display as shown below.

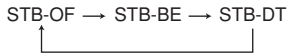

- STB-BE

Short beep sounds to indicate that your transmission is end.

- STB-DT

The DTMF tones can be transmitted at the end.

Write the DTMF tones in "M St" of the Auto Dialer memory.

Please refer to "Programming the Auto Dialer Memories" (page 40)

9. Cloning and Packet Operation

9.1 Cloning

The memory data and customized operational parameters can be transferred from a Master unit to other DJ-V57 (Slave units).

9.1.1 Cable Connection

- Make sure that both units are turned off before connecting the cable.
- Connect the Microphone/Speaker jack on the Master unit with the Slave unit using an optional clone cable (EDS-11) as shown below, then turn on both units.

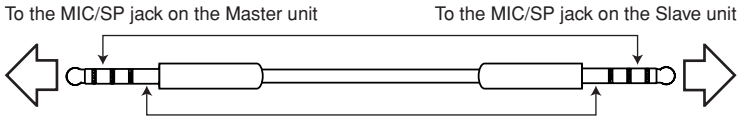

* Be sure to securely screw the plug all the way down to the bottom of the jack.

9.1.2 Master/Slave Units

Press the PTT key three times while holding down the MONI key.

"CLONE" is displayed on the LCD.

NOTE:

This operation is required also to program the data using utility software.

9.1.3 Master Unit Operation

1. In the Clone mode, press the PTT key of the master unit. "SD***" is displayed on the LCD, and starts the data-transfer.

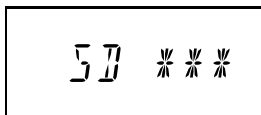

2. After the transfer is completed successfully, "PASS" is displayed.
3. Turn off the unit. Repeat the same sequence to clone more units.

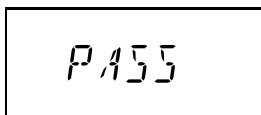

Stop moving the SD***, COMERR etc. on the display means that the cloning is failed. Please read below and repeat the procedure.

9.1.4 Slave Unit Operation

1. When the data is sent from the master unit, "LD***" is displayed on the receiving unit, and the data-transfer starts.

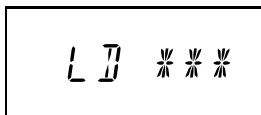

2. After the transfer is completed, "PASS" is displayed.
3. After the cloning is done, turn off the unit by pressing the  key and remove the cable. Repeat the same sequence to clone more units.

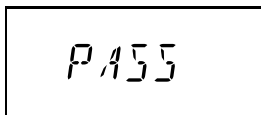

In case the transfer fails, please turn off the slave unit and perform the reset sequence (page 57) to turn on again before retry. If you quit cloning of this slave unit, please reset it anyway otherwise it may not work properly.



Caution

- Don't disconnect the cable during data transmission. If you disconnect the cable at this time, "COMERR" is displayed on the LCD of the master unit, and transmission is aborted.
- When data transfer is performed using the Clone function, all settings in the slave unit are overwritten by the master unit settings. There is NO data back-up available in unit's memory.

9.2 Packet Operation

Packet operation is one of the data communication methods, which enables data transmission and reception with a personal computer through an optional TNC unit available from third-parties.

9.2.1 Packet Operation Connections

Connect the packet communication TNC (Terminal Node Controller) terminals to the SP (Ø3.5 mm plug) and MIC (Ø2.5 mm plug) connectors on the top of the transceiver.

- Input level adjustment: The unit doesn't have microphone and speaker level adjustment circuit. Adjust their level on the TNC side.
- Output level adjustment: Use the audio output (*VOL key) of the unit to adjust the output level from MIC/SP terminal.

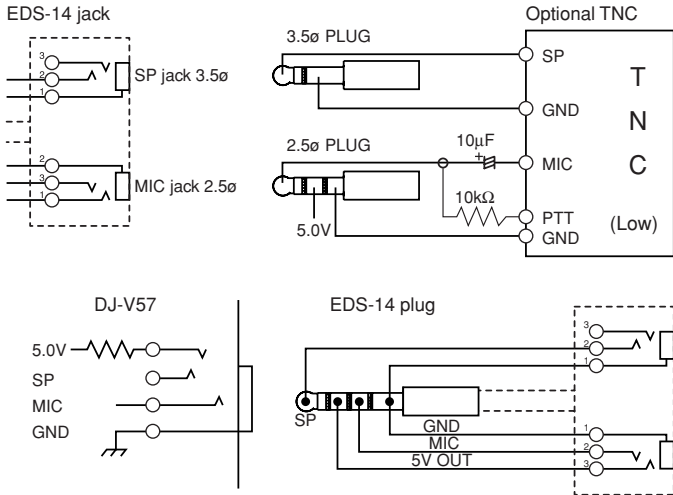

*Power is supplied from internal 5V line through 100Ω resistor.



Caution

- Refer to the TNC's instruction manual when connecting the TNC unit to other devices (personal computer etc.). If the unit, TNC unit and connected personal computer are set too close, noise between them may cause interference.
- Turn the battery save function off during packet operations.
- DJ-V57 operates up to 1200bps only.

10. Maintenance and Reference

10.1 Troubleshooting

Please check the list below before concluding that the unit needs to be serviced. If a problem persists, please reset the unit. The setting/CPU program-related troubles are often resolved by the reset.

Symptom	Possible Cause	Action
Nothing appears on the display when turning on the power.	Poor battery pack connection.	Check that the battery pack terminals are clean, and pack is correctly attached.
	Battery is exhausted.	Recharge or replace the battery (pages 60-65).
	You are releasing the key too quickly.	Hold the power key down until the display shows figures.
No Speaker audio. No reception.	Volume too low.	Adjust the audio level (page 23).
	Squelch level too high.	Adjust the squelch (page 23).
	Tone squelch is on.	Turn off tone squelch (page 37).
	DCS is on.	Turn off DCS (page 38).
Frequency display is incorrect.	You are pressing the PTT key and transmitting.	Release PTT key.
	CPU error.	Reset the unit (page 57).
Won't scan.	A channel name is set.	See Naming Memory Channels function (page 35).
	Squelch is unmuted.	Set squelch so that noise mutes (page 23).
Frequency and memory number don't change.	Keylock is on.	Turn off Keylock (page 34).
	Transceiver is in the Call mode.	Select the VFO or Memory mode.
Key entry not possible.	Keylock is on.	Turn off Keylock (page 34).
Repeater-Access can't be used.	Incorrect setting of parameters.	Set the correct parameters to suit your local repeaters (page 30).
Can't transmit. Display flashes or goes out when you transmit.	Battery is exhausted.	Recharge or replace the battery (pages 60-65).
Can't transmit. Can't talk to other stations.	Not pressing the PTT key firmly enough.	Press the PTT key and confirm that TX/RX lamp lights red.
	Off-frequency.	Be sure that you are in the TX range and/or check shift status.
	Incorrect frequency.	Check the shift status/repeater settings.
The display flashes or disappears during reception.	Battery is exhausted.	Recharge battery or replace the battery (pages 60-65).

- Please be advised that the water-proof shields including jack caps are subject to consume. The factory warranty for IPX7-grade water-proof is 1 year. Please consult with your local dealer when further service-assistance may be necessary. Please visit alincocom.com's "DISTRIBUTION" menu to locate the nearest dealer.
- For the DJ-V57, updated firmware (operating program written on the chip inside the transceiver) may be delivered from the web site.

10.2 Resetting

10.2.1 All Resetting

When you reset the unit, all settings are returned to the initial factory settings. The reset deletes the programmed memory channels also.

1. Turn on the unit with the FUNC and  keys pressed together.
2. All the icons appear on the display.

Release the keys. All display will disappear for 2 seconds, and then reappear. The initial mode is the VFO.

NOTE:

THE ALL RESET DELETES ALL THE MEMOORIES.

Please take notes of the important data and keep it for future reference.

There is no way to restore the memory data once it's deleted.

10.2.2 Partial Resetting

When you perform partial resetting, all settings except the programmed memory channels are returned to the factory defaults.

1. Turn on the unit with the FUNC key pressed.
2. All the icons appear on the display.

Release the keys. All display will disappear for 2 seconds, and then reappear. The initial mode is the VFO.

Factory default settings

	DJ-V57T	DJ-V57E	DJ-V57T1
VFO/CALL Frequency (VHF)	145.000MHz	145.000MHz	145.000MHz
VFO/CALL Frequency (UHF)	445.000MHz	435.000MHz	415.000MHz
Memory Channel	0 ~ 199ch Blank	0 ~ 199ch Blank	0 ~ 199ch Blank
Channel Step	5kHz	12.5kHz	5kHz
Shift	None	None	None
Offset Frequency (VHF)	0.6MHz	0.6MHz	0.6MHz
Offset Frequency (UHF)	5MHz	7.6MHz	5MHz
Tone Setting	None	None	None
Tone Frequency	88.5Hz	88.5Hz	88.5Hz
DCS Setting	None	None	None
DCS Code	23	23	23
Transmitter Output	Low	Low	Low
Auto Dialer Code	None	None	None
Keylock	off	off	off
Time-Out-Timer	Off	off	Off
Auto-Power-Off	off	off	off
Volume Level	15	15	15
Squelch Level	3	3	3
Repeater Shift	-	-	-
Repeater Offset Frequency (VHF)	0.6MHz	0.6MHz	0.6MHz
Repeater Offset Frequency (UHF)	5MHz	7.6MHz	5MHz
Repeater Tone Setting	88.5Hz	88.5Hz	88.5Hz

10.3 Options

EBP-63/64	Li-ion Battery Pack (DC 7.4V 1100mAh / 1600mAh)
EBP-65/66	Ni-MH Battery Pack (DC 7.2V 700mAh / 2000mAh)
EDC-36	Mobile Cigarette Lighter Adapter with Active Noise Filter
EDC-37	External DC Power Supply Cable
EDC-43	Mobile Cigarette Lighter Cable for Charging Ni-MH Packs
EDC-143T/E/UK	Ni-MH Trickle Battery Charger (T:120V / E:230V / UK:230V UK plug)
EDC-143R	Multiple-Charger Basket (An external DC power supply required)
EDC-144A/E/UK	Rapid Battery Charger (A:120V / E:230V / UK:230V UK plug)
EDC-144R	Multiple-Charger Basket (An external DC power supply required)
EDC-159T/E	Rapid Li-ion Battery Charger (T:120V / E:230V)
EDC-160T/E	Rapid Ni-MH Battery Charger (T:120V / E:230V)
EDC-146/147/148	Wall Charger (T:120V / E:230V / UK:230V UK plug)
EDH-34	Dry Cell Case
EDS-14	Microphone/Speaker Cable
EDS-11	Clone Cable
EME-4	Earphone Microphone*
EME-6	Earphone*
EME-26	Earphone* (curl-cord)
EME-12A	Headset with VOX*
EME-13A	Earphone and MIC with VOX*
EME-15A	Tie-pin MIC with VOX*
EME-32A	Heavy-duty Earphone Microphone
EME-34A	Earphone Microphone*
EME-36A	Earphone Microphone
EMS-47	Speaker Microphone with Audio Control*
EMS-59	Speaker Microphone*
EMS-62	Speaker Microphone
ERW-7	PC Programming cable (USB port)*
ESC-41	Soft Case (For all battery packs)

• Please purchase an optional EDS-14 cable to operate optional accessories marked *.

NOTE:

Please be advised that some of the accessories listed above are not RoHS compliant at the moment this manual has been edited, and they are intended for the sales to where RoHS order is not effective. Please consult with your local dealer for any updates about RoHS compliance of our products before purchase. Use of external power source cables are at your own risk per IEC/EN60950-1. Please refer to "Limited Power Source" on page 11 for details.

IMPORTANT NOTE:

All accessories except EBP-63/64/65/66 and soft cases above listed are NOT water-proof. Never use these accessories in wet conditions.

- When using EDC-36, EDC-37, EDC-43, EDC-146, EDC-147, connect them to the unit first before turning on the unit.
- EBP-63, 64, 65 and 66 are IPX7-grade water-proof only when correctly attached and used with DJ-V57.

10.3.1 Microphone/Speaker Cable (EDS-14)

1. Turn off the unit.
2. Turn the plug clockwise until it stops. Check to be sure it is securely connected.
3. Connect the Microphone/Speaker plugs to the each jack.

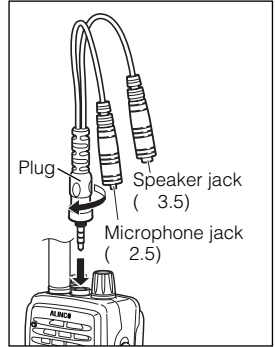

10.3.2 Battery Packs

The battery packs aren't fully charged when shipped. Please charge the pack completely before use.

Available Battery Packs for DJ-V57:

EBP-63	Li-ion Battery Pack (DC 7.4V 1100mAh)
EBP-64	Li-ion Battery Pack (DC 7.4V 1600mAh)
EBP-65	Ni-MH Battery Pack (DC 7.2V 700mAh)
EBP-66	Ni-MH Battery Pack (DC 7.2V 2000mAh)

Charging Battery Packs

Refer to the chart below for the combination of the proper battery pack and charger. The indicates the usable combination, (* hrs) means the approximate time necessary to full charge the empty pack.

Chargers	Battery Packs		Ni-MH Battery Pack	
	EBP-63	EBP-64	EBP-65	EBP-66
Trickle Charger EDC-143	<input type="radio"/>	<input type="radio"/>	<input type="radio"/> (10hrs)	<input type="radio"/> (14hrs)
Rapid Charger EDC-144	<input type="radio"/> (2hrs)	<input type="radio"/> (3hrs)	<input type="radio"/> (1.5hrs)	<input type="radio"/> (3.5hrs)
Wall Charger EDC-146/147/148	<input type="radio"/>	<input type="radio"/>	<input type="radio"/> (10hrs)	<input type="radio"/> (30hrs)

10.3.3 Using the Chargers



Caution

Please also read the "Warning" (page 7 of this manual) and the safety instruction that is included in the accessories' package before operating for your safety.

Charging with the EDC-143 (Trickle Charger)

Please make sure that following items are included in the package.

- EDC-143T: EDC-143 basket, EDC-146 adapter (AC 120V), insulation sheet
- EDC-143E: EDC-143 basket, EDC-147 adapter (AC 240V), insulation sheet
- EDC-143UK: EDC-143 basket, EDC-148 adapter (AC 240V), insulation sheet
- EDC-143R: EDC-143 basket, connection cable, insulation sheet, 2 screws, connective stay



Caution

Before using them for the first time, attach the insulation sheet to cover the screw-terminals at the bottom to avoid short-circuiting. Please refer to page 64 for instruction.

1. Connect the AC adapter plug to the DC-IN jack on the back of the basket.

*The design of the AC adapter may vary depending on the models.

2. Connect the adapter to an outlet.

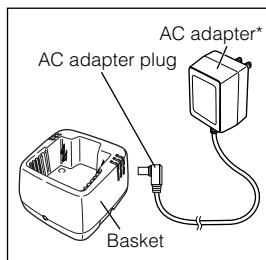

- Press the sides of the adjustment plate, and attach it to the proper grooves of the basket according to the size of the battery pack. Make sure that the characters A, B and C on both sides of the stand match each other and the plate is placed all the way down to the bottom.

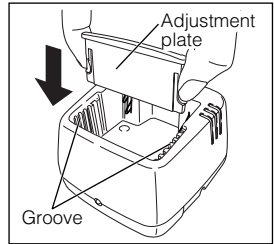

Installation Positions of the Adjustment Plate

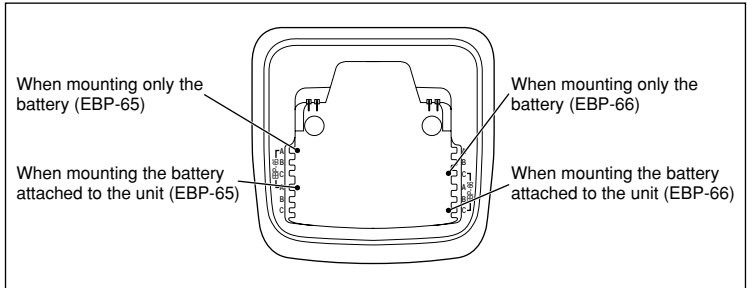

- Mount the battery (with or without being attached to the unit) in the basket as shown. Turn off the unit while charging.

The red indicator on the basket turns on and charging starts.

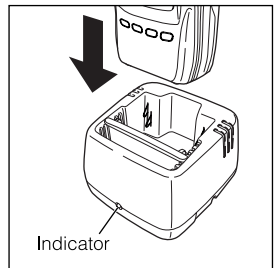

- After charging time is elapsed (page 59), remove the battery pack from the basket. The red indicator stays turned on as long as the pack is mounted on the basket regardless of the charging status.

Specifications

	EBP-65	EBP-66
Input Voltage	DC 12.0V 150mA	DC 12.0V 150mA
Operating Temperature Range	0°C~+40°C (+32°F~+104°F)	0°C~+40°C (+32°F~+104°F)
Charging Current	70mA	140mA
Battery Capacity	DC 7.2V 700mAh	DC 7.2V 2000mAh
Charging Time	Approx. 10 hours	Approx. 14 hours

*The charging time may vary depending on the condition of the battery pack and the temperature of the environment.

NOTE:

Refer to page 64 for information about how to charge the battery using additional baskets.

Charging with the EDC-144 (Quick Charger)

Please make sure that following items are included in the package

- EDC-144A: EDC-144 basket, EDC-112 adapter (AC 120V), insulation sheet
- EDC-144E: EDC-144 basket, EDC-151 adapter (AC 240V), insulation sheet
- EDC-144UK: EDC-144 basket, EDC-152 adapter (AC 240V), insulation sheet
- EDC-144R: EDC-144 basket, connection cable, insulation sheet, 2 screws, connective stay



Caution

Before using them for the first time, attach the insulation sheet to cover the screw-terminals to avoid short-circuiting. Please refer to page 65 for instruction.

1. Connect the AC adapter plug to the DC-IN jack on the back of the basket.

*The design of the AC adapter may vary depending on the models.

2. Connect the adapter to an outlet.

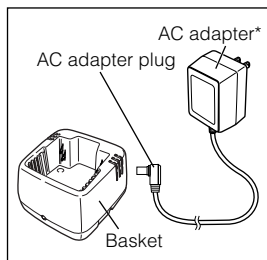

3. Press the sides of the adjustment plate, and attach it to the proper grooves of the basket according to the size of the battery pack. Make sure that the characters A, B and C on both sides of the stand match each other and the plate is placed all the way down to the bottom.

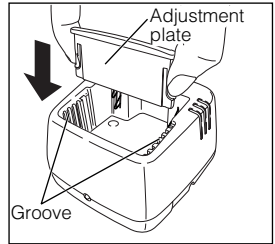

Installation Positions of the Adjustment Plate

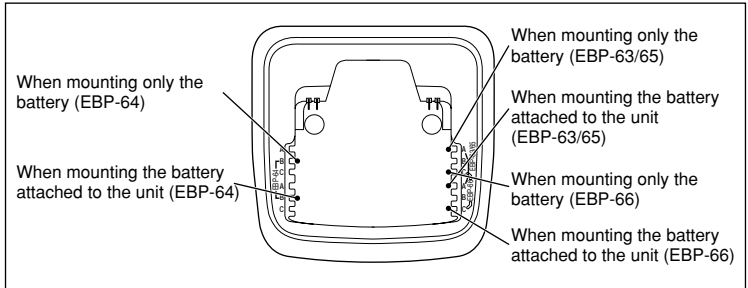

4. Mount the battery (with or without being attached to the unit) in the basket as shown. Turn off the unit while charging.

The red indicator on the basket turns on and charging starts.

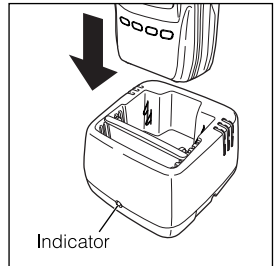

5. The red indicator turns off when the charge is completed. Remove the battery pack from the basket.

NOTE:

The flashing red indicator means that the charger isn't working properly. Stop using it immediately, remove the cord from the outlet and consult with your local Alinco dealer.

Specifications

	EBP-63	EBP-64	EBP-65	EBP-66
Input Voltage	DC 12.0V 700mA			
Operating Temperature Range	0°C~+40°C (+32°F~+104°F)			
Charging Current	600mA			
Battery Capacity	DC 7.4V 1100mAh	DC 7.4V 1600mAh	DC 7.2V 700mAh	DC 7.2V 2000mAh
Charging Time	Approx. 2 hours	Approx. 3 hours	Approx. 1.5 hours	Approx. 3.5 hours

*The charging time may vary depending on the condition of the battery pack and the temperature of the environment.

Connecting Additional Baskets (EDC-143R/144R)

In order to use EDC-143R and EDC-144R, an optional power supply (IEC/EN 60950-1 compliant) of 1A/5A minimum respectively is required.

A DC cable isn't included in the package; the suggested DC cable is 20 AWG wire, shorter than 1m (3feet) in length.

1. Make sure that the output voltage of the power supply is DC 12.0V.

2. Connect the terminals with the provided connection cable, the red cable to the positive and the black cable to the negative terminals.

The additional basket can be connected up to 5 in the same way.

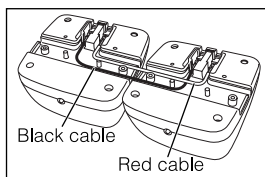

3. Connect the ends of the DC cable to the terminals of the basket.

* This DC cable isn't provided in the products.

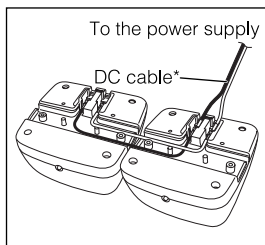

4. Attach the connective stay and the insulation sheets to cover the terminals to avoid short-circuiting.

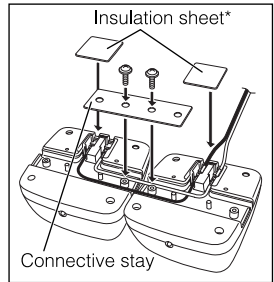

Caution

This insulation sheet marked * is provided to all EDC-143/144 series chargers. Please be sure to cover the bottom of the charger with this sheet as shown above to prevent short-circuiting before using them for the first time.

5. Connect the other ends of the DC cable to the output terminals of the power supply. Be mindful to the polarities of the terminals.

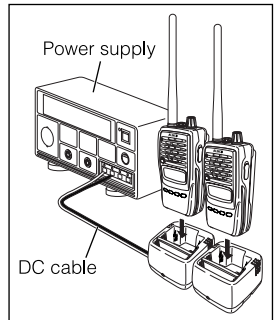

10.3.4 Dry Cell Case

An EDH-34 is available for operation with using AA cells.

Lift up the catches on the top of the case to remove the cover.

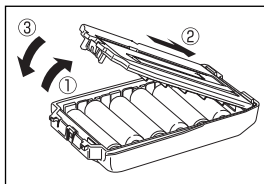

Place 6 AA cells, then close the cover in order of then . Be sure that the cover is securely closed.

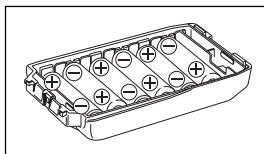

Caution About Handling Dry Cell Case:

- This dry cell case isn't water-proof.
- Be extra-cautious to the polarity of the cells (+)/(-). Misplacing cells may result in leak, fire or explosion.
- Use new batteries of the same type and brand when placing them.
- Use of rechargeable cells is prohibited and the manufacturer declines any responsibilities for damages/injuries that may cause to the users and their properties.
- It is recommended to clean the battery contacting terminals with a clean dry cloth from time to time.
- Risk of explosion if batteries are replaced by an incorrect type.
- Batteries are recyclable. Please check the local rules for proper recycle/disposal in your area.

11. Specifications

General

Frequency range (T ver)	TX	144.000~147.995MHz 420.000~449.995MHz	144.000~147.995MHz 420.000~449.995MHz * Guaranteed range per specifications
	RX	136.000~173.995MHz 400.000~511.995MHz	
Frequency range (E ver)	TX	144.000~145.995MHz 430.000~439.995MHz	
	RX	144.000~145.995MHz 430.000~439.995MHz	
Modulation		F3E(FM)	
Channel steps		5, 10, 12.5, 15, 20, 25 & 30kHz	
Memory channels		200 channels, 2 CALL channel (V/U) 2 Program Scan (V/U)	
Antenna impedance		50Ω (unbalanced)	
Frequency stability		±2.5ppm±	
Power supply		DC7.0~16.0V (EXT DC-IN)	
Current drain (VHF / UHF) DC13.8V * Approx	Tx (Power 5W)	1.6A / 1.9A	
	Rx (SP 500mW)	250mA	
	Stand-by	70mA / 80mA	
	Battery save on	27mA	
Temperature range	EXT DC-IN	-10°C~+60°C (+14°F~140°F)	
	Battery Pack	-10°C~+45°C (+14°F~113°F)	
Ground		Negative ground	
Dimension (with EBP-63)		58(W)x110(H)x34(D) mm (2.28"(W)x4.33"(H)x1.34"(D))	
Weight *Approx		270g/9.6oz (with EBP-63 & antenna)	
Subaudible Tone (CTCSS)		encode/decode 39 tones	
Digital Code SQ. (DCS)		encode/decode 104 codes	
DTMF		16 Buttons Keypad (encode)	

Transmitter

Output power	High (VHF)	DC13.5V EBP-63/65	5W 5W
	High (UHF)	DC13.5V EBP-63/65	5W 4.5W
	Middle		2W (Initialization)
	Low		0.5W
	Modulation	Variable reactance frequency modulation	
Spurious emission	-60dB or less		
Max. deviation (WFM / NFM)	$\pm 5\text{kHz} / \pm 2.5\text{kHz}$		
Mic. impedance	2k Ω		

Receiver

Receive system	Double conversion superheterodyne
Sensitivity (VHF/UHF) *12dB SINAD	-14dBu / -12dBu
Intermediate frequencies	38.85MHz (1st) / 450kHz (2nd)
Selectivity	-6dB: 12kHz or more / -60dB: 35kHz or less
Audio output power	500mW (MAX) 400mW (8 Ω , 10% distortion)

The following table lists available characters.

А	A	Т	T	Г	Г	0	0
В	B	U	U	Д	Д	1	1
С	C	V	V	Ё	Ё	2	2
Д	D	W	W	Ж	Ж	3	3
Е	E	X	X	З	З	4	4
Ф	F	Y	Y	И	И	5	5
Г	G	Z	Z	Й	Й	6	6
Н	H		space	Л	Л	7	7
И	I	*	*	П	П	8	8
У	J	#	#	У	У	9	9
К	K	+	+	Ф	Ф		
Л	L	-	-	Ц	Ц		
М	M	/	/	Ш	Ш		
Н	N	\	\	Ъ	Ъ		
О	O	=	=	Ы	Ы		
Р	P	<	<	Ь	Ь		
Q	Q	>	>	Э	Э		
Р	R	\$	\$	Ю	Ю		
С	S	_	_	Я	Я		

Memory Mode Structure

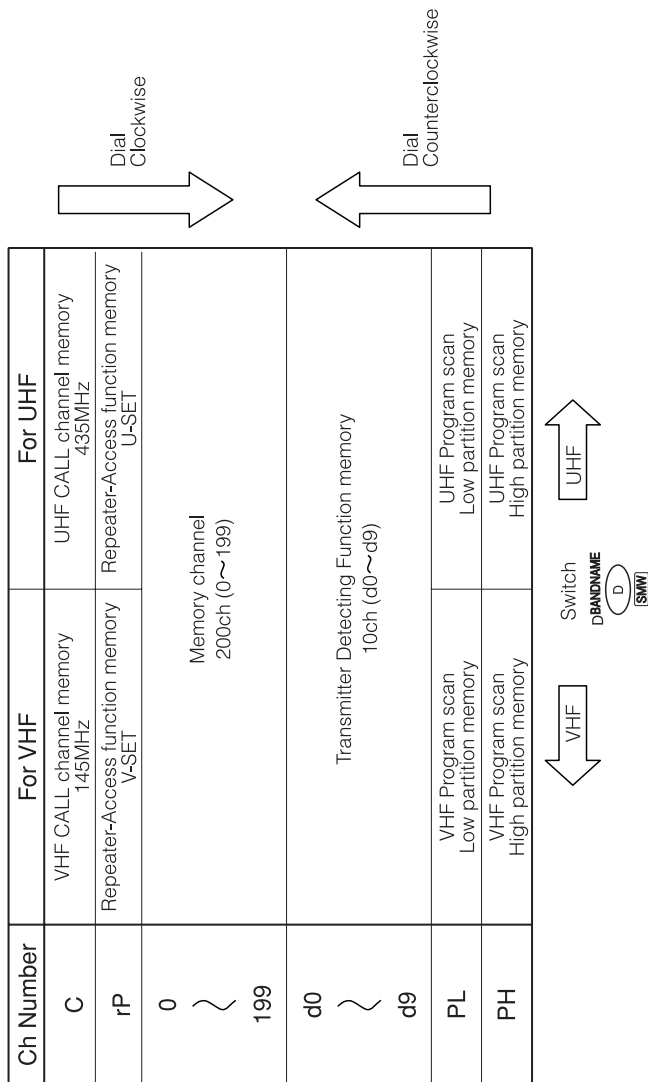

Quick manual

<Turning On the Power> page 23

Hold the  key down for a second.

<Adjusting the Audio Output (Volume)> page 23

1. Press the  key.
2. Rotate the dial to increase or decrease the level.

<Adjusting the Squelch> page 23

1. Press the  key.
2. Rotate the dial to increase or decrease the level.

<Selecting the Output Level> page 32

Press the FUNC key, and while  is displayed on the LCD, press the  key

*Changes in order of 0.5W, 2W, and 5W.

<Quick-write memory> page 29

Press the  key for more than 2 seconds.

ALINCO, INC.

Yodoyabashi Dai-bldg 13F

4-4-9 Koraibashi, Chuo-ku, Osaka 541-0043 Japan

Phone:+81-6-7636-2362 Fax: +81-6-6208-3802

<http://www.alinco.com>

E-mail:export@alinco.co.jp