

FT-73R

TECHNICAL SUPPLEMENT

This booklet contains supplemental technical information related to the FT-73R for use with the FT-73R Operating Manual. Service or repairs to the FT-73R transceiver should be performed by qualified technicians only.

FT-73R

TECHNICAL SUPPLEMENT



This manual is intended to serve as a supplement to the FT-73R Operating Manual. Detailed information regarding functions, specifications, options and operation has been provided in the Operating Manual, and is not reprinted herein. Therefore, this supplement is not intended to serve as an independent reference, but to be used in conjunction with the information provided in the Operating Manual.

Because of the compactness and complexity of the double-sided glass-epoxy circuit boards used in the FT-73R four layout diagrams are provided for each board. Each side of the board is identified by the type of the majority of components installed on that side. In most cases one side has only chip components, and the other has either a mixture of both chip and lead components (trimmers, coils, electrolytic capacitors, packaged ICs, etc.), or lead components only. The two "obverse" views depict the board as it is seen when viewed directly with the eye, while the two "reverse" views depict the unseen side of the board as it would appear if one were to peer through the board from the other side without seeing the components and tracks on the near side.

While we believe the technical information in this manual is correct, Yaesu assumes no liability for damage that may occur as a result of typographical or other errors that may be present. Your cooperation in pointing out any inconsistencies in the technical information would be appreciated.

Yaesu Musen reserves the right to make changes in the circuitry of this transceiver, in the interest of technological improvement, without notification of the owners.

MOTHER BOARD

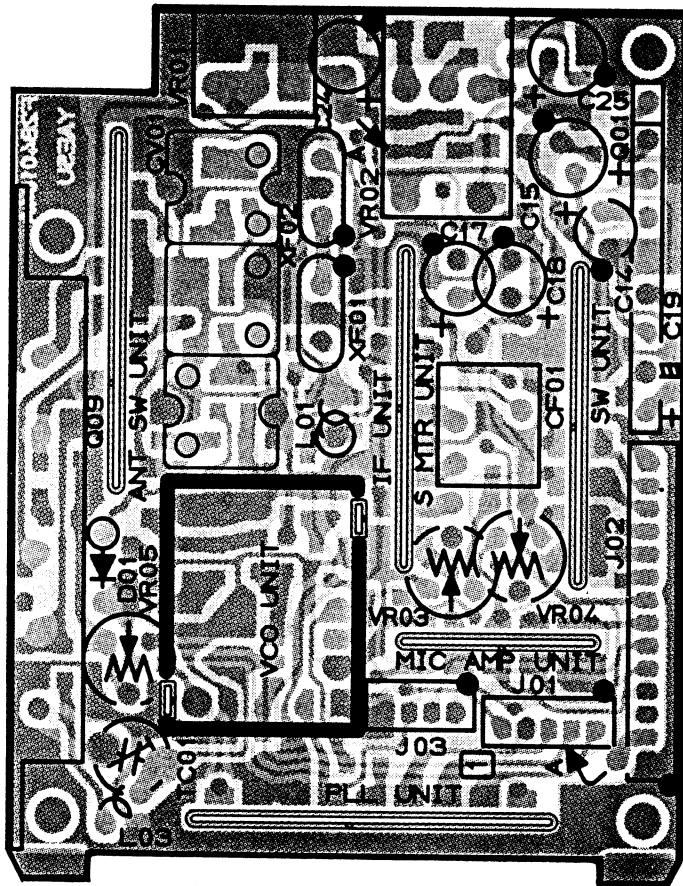

(obverse view of "component" side)

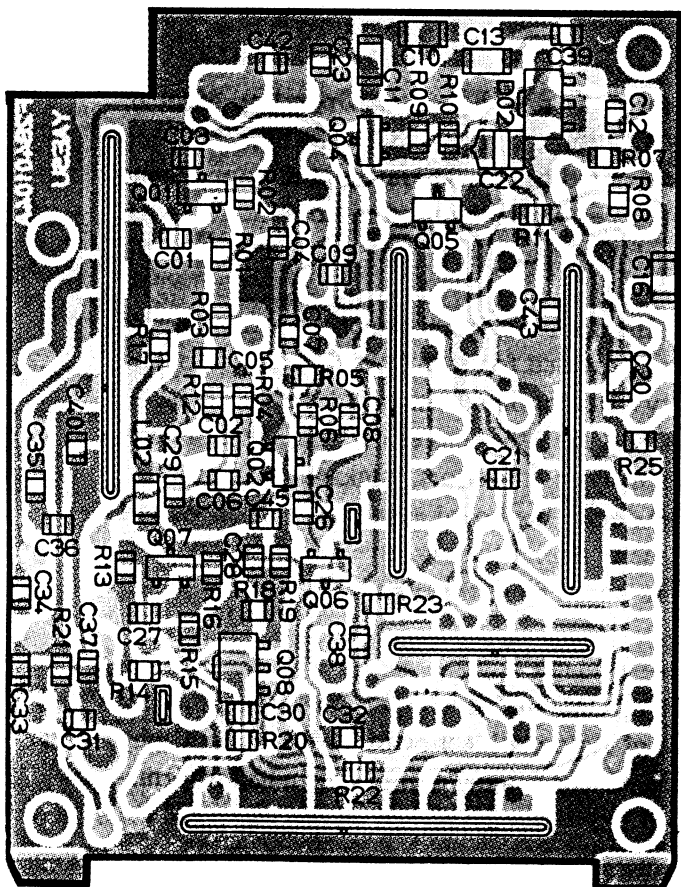

(reverse view of "chip-only" side)

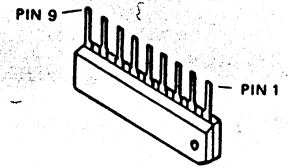

LA4145 (Q103)

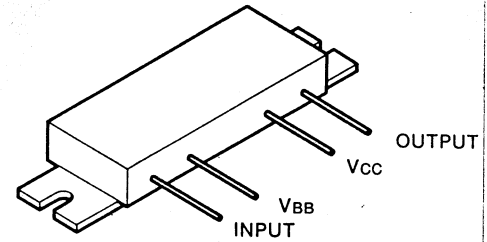

M57797MA (Q109)

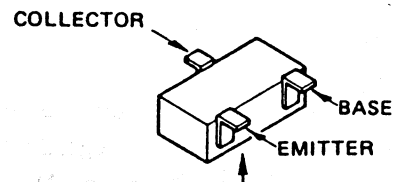

Marked Surface

- 2SA1162GR (SG) : (Q104)
- 2SC2712GR (LG) : (Q105)
- 2SC3356 (R22) : (Q101,102)
- 2SC3585 (R42) : (Q107)
- FA1A4M (L33) : (Q106)

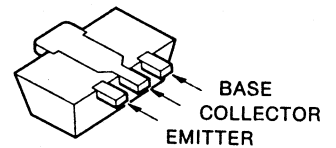

2SC2954 (Q108)

MOTHER BOARD

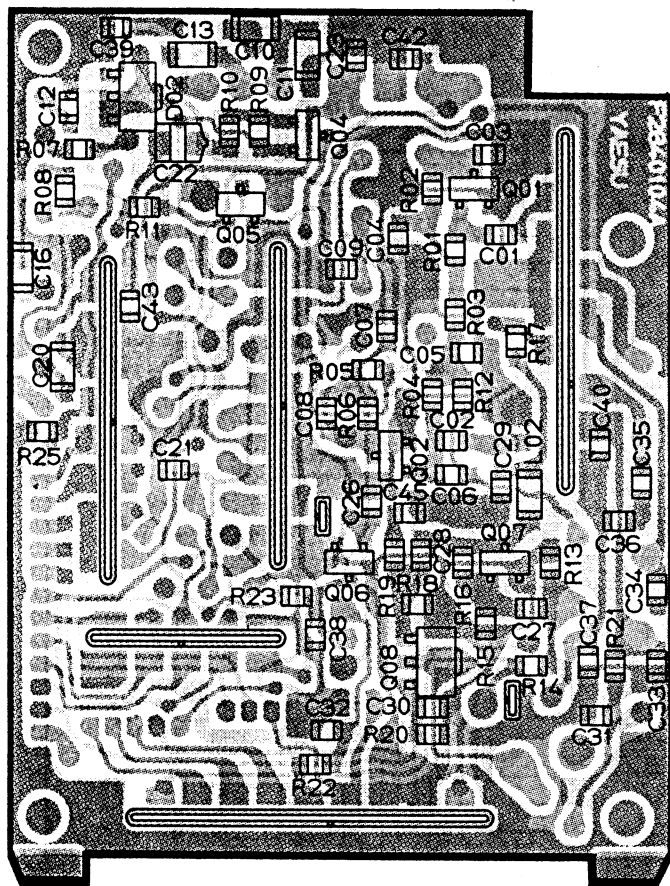

(obverse view of "chip-only" side)

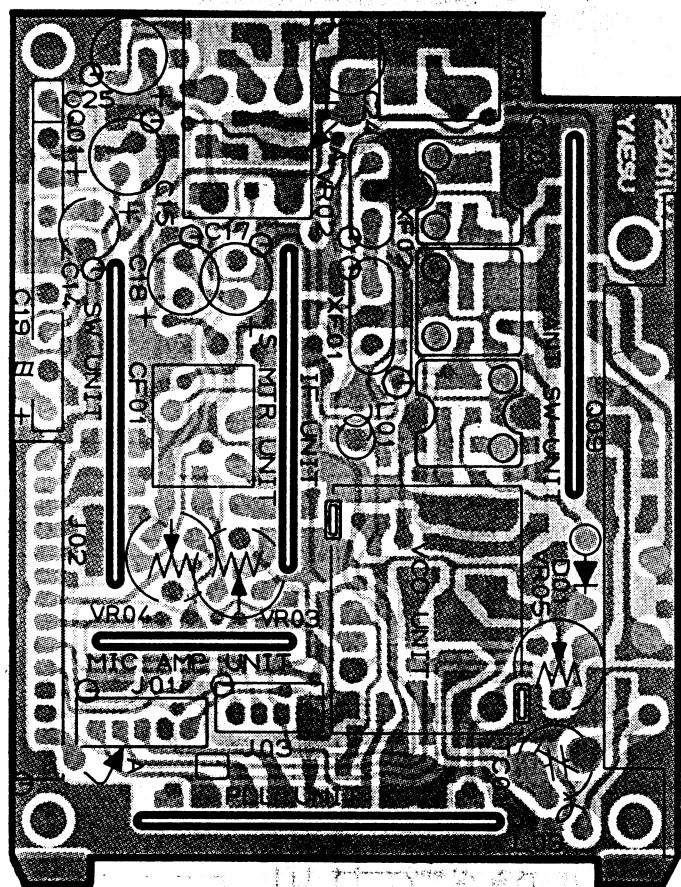

(reverse view of "component" side)

CHIP SEMICONDUCTOR CROSS-REFERENCE

PART LOCATION NO.	ORIGINAL	REPLACEMENT		
	NOMENCLATURE (MARKING) AND PART NUMBER	NOMENCLATURE (MARKING) AND PART NUMBER		
Q104,605,606,607,1002,1012	2SA1162GR(SG) G3111620G	2SA812F/G(M6/M7) G3108120F/G	2SA1052C/D(MC/MD) G3110520C/D	2SA1179F/G(M6/M7) G3111790F/G
Q103,602,603,608,801,802,902, 903,905,906,1003,1004,1005, 1006,1010	2SC2712GR/BL(LG/LL) G3327120G/B	2SC1623F/G(L6/L7) G3316230F/G	2SC2462C/D(LC/LD) G3324620D/D	2SC2812F/G(L6/L7) G3328120F/G
Q701	M5224FP G1090726	LA6324M G1090559		
D1001,1002	1SS181(A3) G2070001	MC2836(A4) G2070024	DCA015TA(A4) G2070014	
D603,1007,1008	1SS184(B3) G2070009	MC2838(A6) G2070018	DCB015TA(A6) G2070021	

* Semiconductors not listed above may be replaced only with original types.

MOTHER BOARD

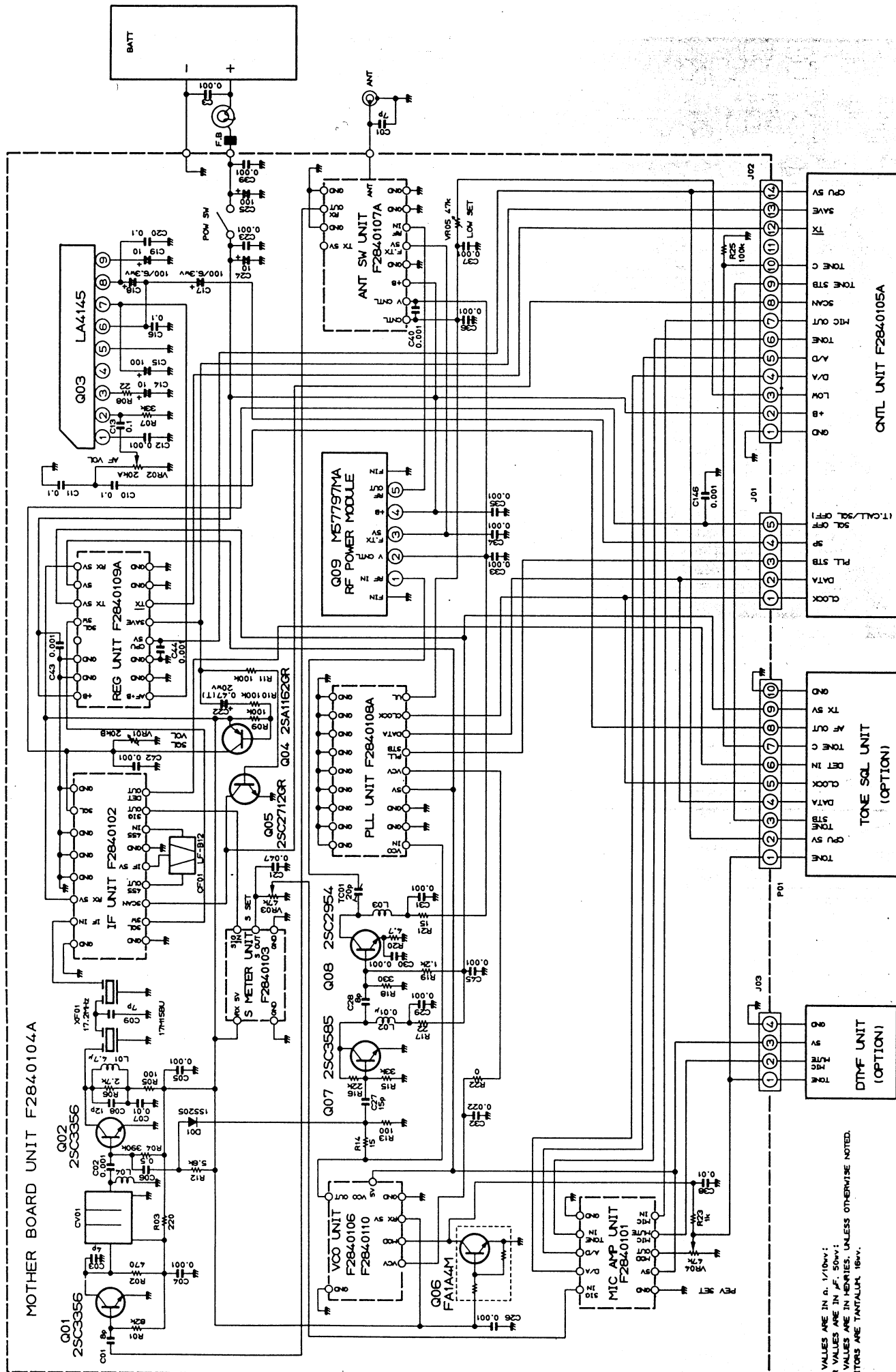

IF UNIT

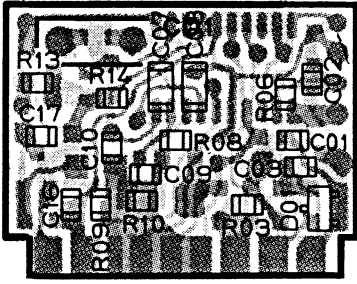

(obverse view of "mixed-component" side)

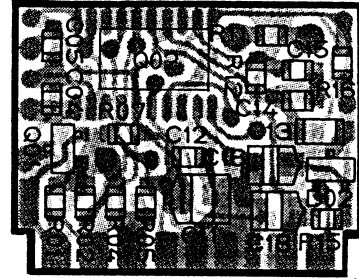

(obverse view of "chip-only" side)

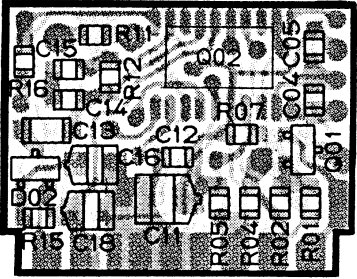

(reverse view of "chip-only" side)

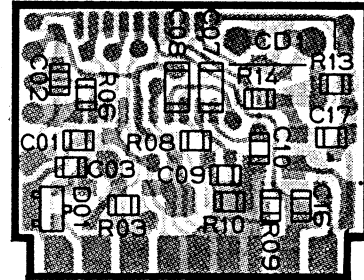

(reverse view of "mixed-component" side)

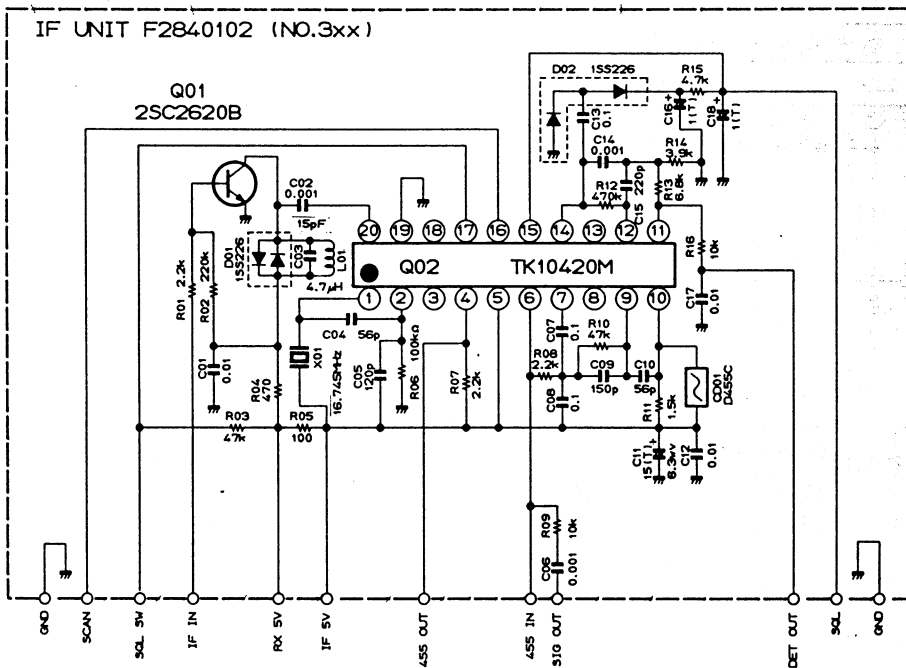

RESISTOR VALUES ARE IN Ω , 1/10W;
CAPACITOR VALUES ARE IN μ F, 50V;
INDUCTOR VALUES ARE IN HENRIES, UNLESS OTHERWISE NOTED.
(T) CAPACITORS ARE TANTALUM, 10V.

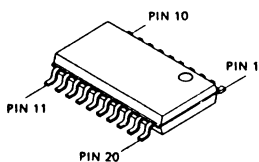

TK10420M (Q302)

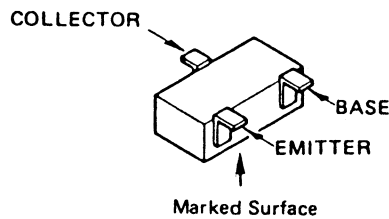

2SC2620B (QB)
(Q301)

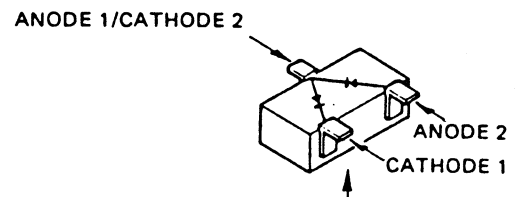

1SS226 (D3)
(D301,302)

PLL UNIT

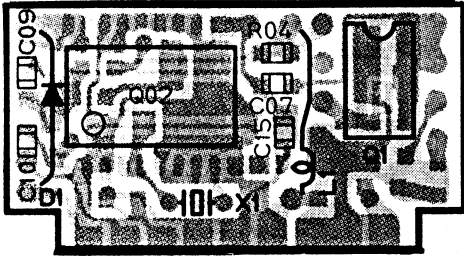

(obverse view of "mixed-component" side)

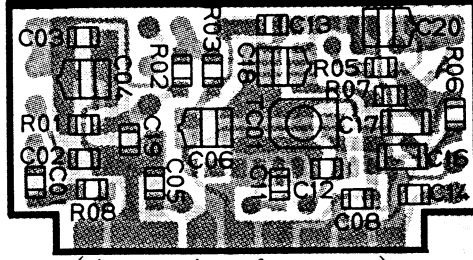

(obverse view of "chip-only" side)

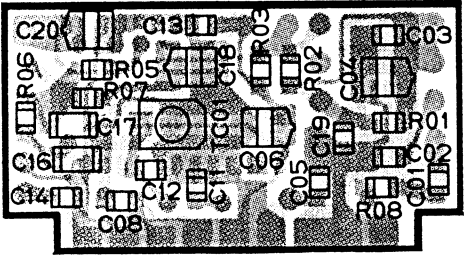

(reverse view of "chip-only" side)

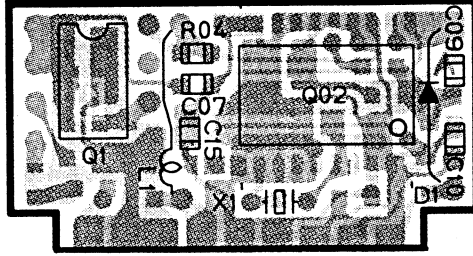

(reverse view of "mixed-component" side)

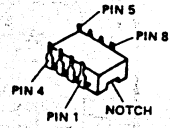

MC1208P (Q401)

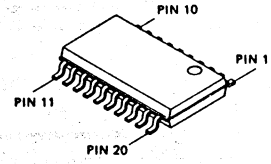

JLC1007P (Q402)

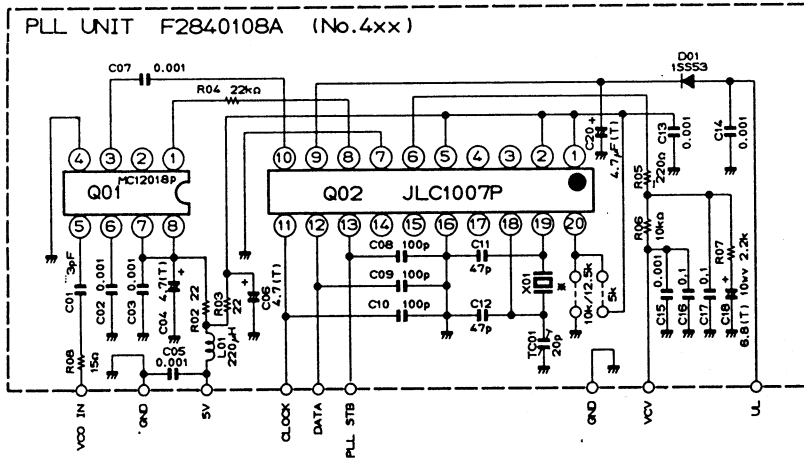

RESISTOR VALUES ARE IN Ω , 1/10V;
CAPACITOR VALUES ARE IN μ F, 50V;
UNLESS OTHERWISE NOTED.
TITICAPACITORS ARE TANTALUM, 6.3V.

X01	10.244kHz-5kHz STEP
X02	12.844kHz-12.5kHz STEP

VCO UNIT

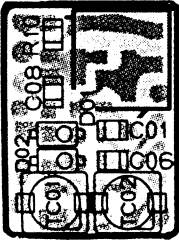

(obverse view of "mixed-component" side)

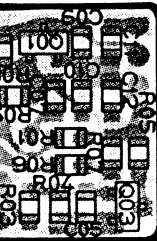
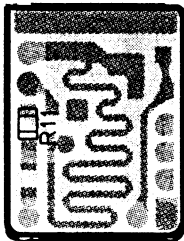

(obverse view of "chip-only" side)

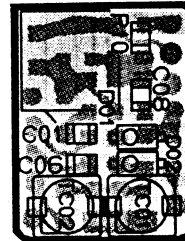
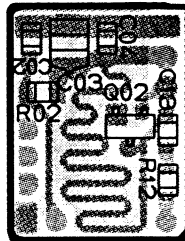

(reverse view of "mixed-component" side)

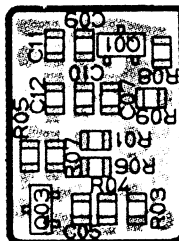

(reverse view of "chip-only" side)

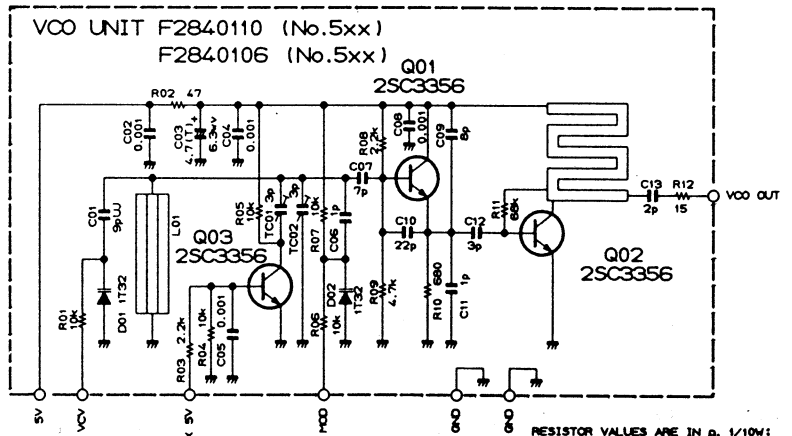
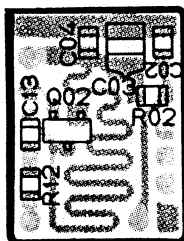

RESISTOR VALUES ARE IN Ω , 1/10V;
CAPACITOR VALUES ARE IN μ F, 50V;
UNLESS OTHERWISE NOTED.
TITICAPACITORS ARE TANTALUM, 16V.

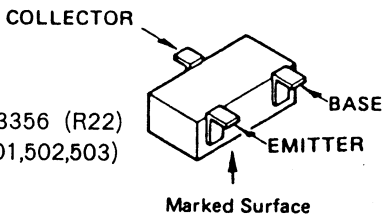

REG UNIT

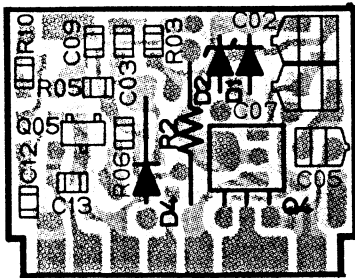

(obverse view of "mixed-component" side)

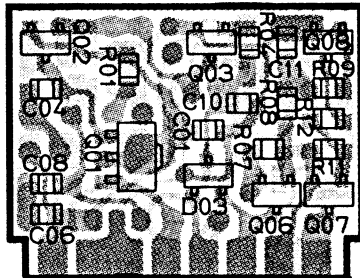

(obverse view of "chip-only" side)

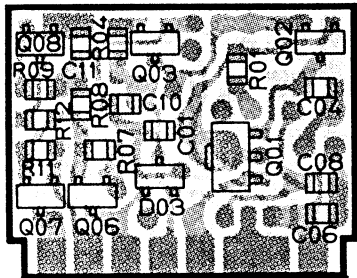

(reverse view of "chip-only" side)

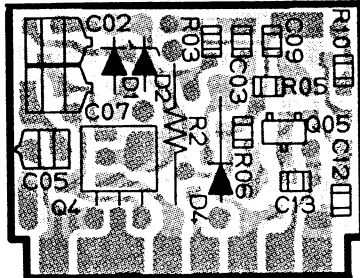

(reverse view of "mixed-component" side)

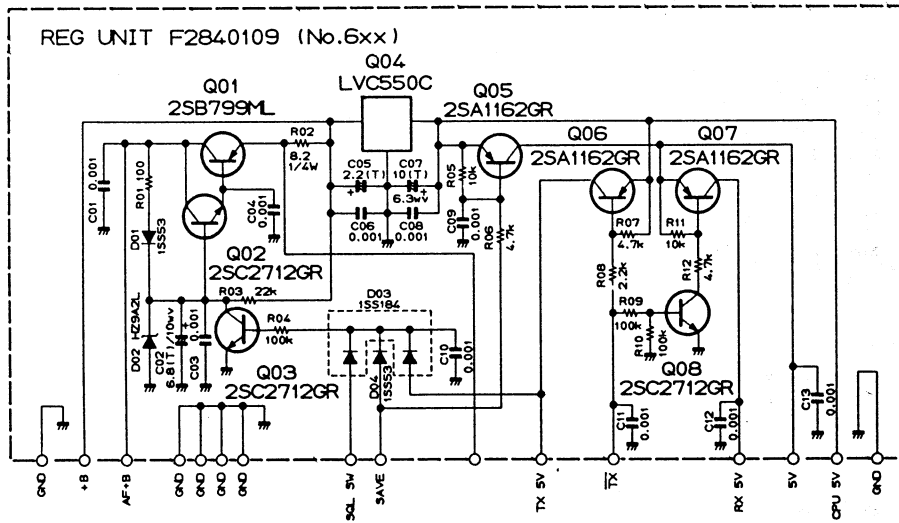
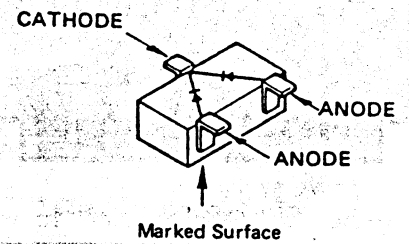
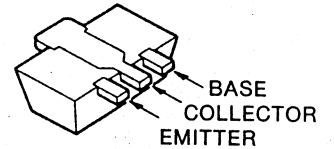
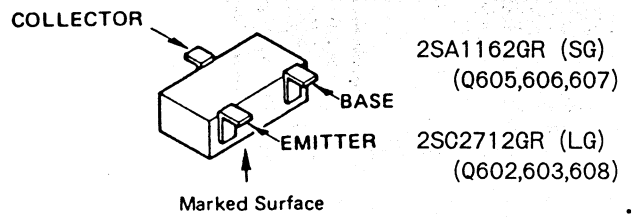
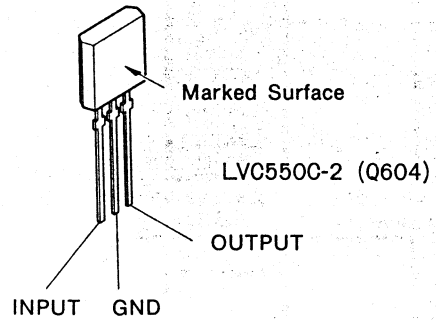

RESISTOR VALUES ARE IN Ω , 1/10W;
CAPACITOR VALUES ARE IN μ F, 50V;
UNLESS OTHERWISE NOTED.
(T) CAPACITORS ARE TANTALUM 16V.

MIC AMP UNIT

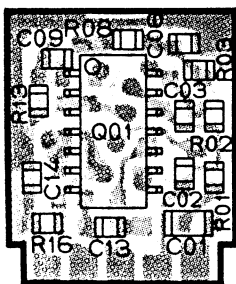

(obverse view of "IC" side)

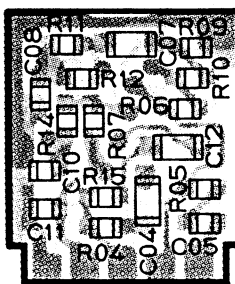

(reverse view of "C-R" side)

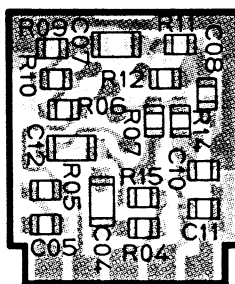

(obverse view of "C-R" side)

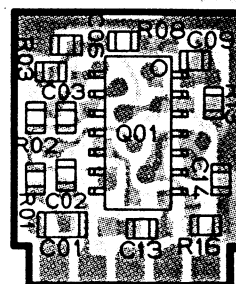

(reverse view of "IC" side)

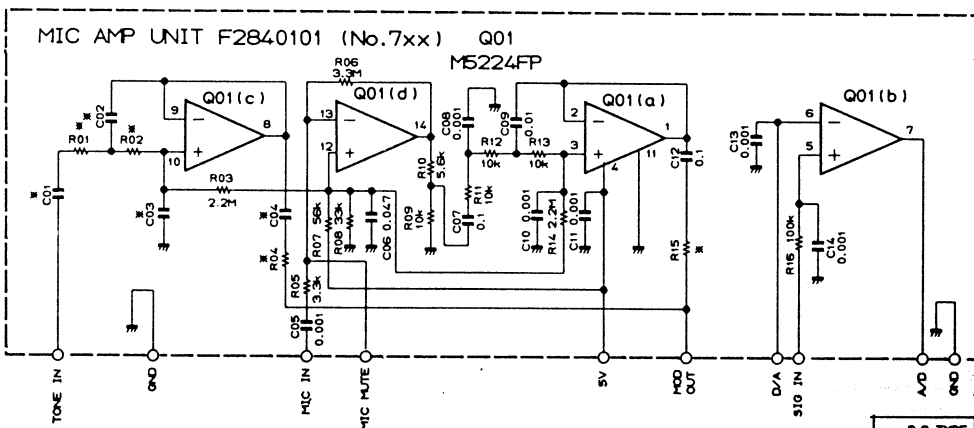
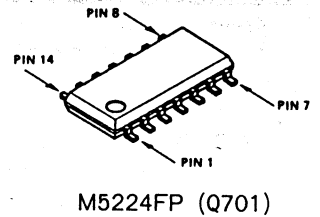

RESISTOR VALUES ARE IN Ω , 1/10W;
CAPACITOR VALUES ARE IN μ F, 50V;
UNLESS OTHERWISE NOTED.

	C01	C02	C03	C04	R01	R02	R04	R15
B.C TYPE	0.1	0.01	0.0022	0.1	10k	10k	33k	100k
A.X.F TYPE	0.1	0.088	0.01	0.1	47k	88k	33k	100k

S METER UNIT

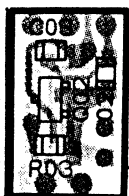

(obverse view of "top" side)



(obverse view of "bottom" side)



(reverse view of "bottom" side)

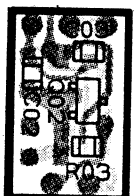

(reverse view of "top" side)

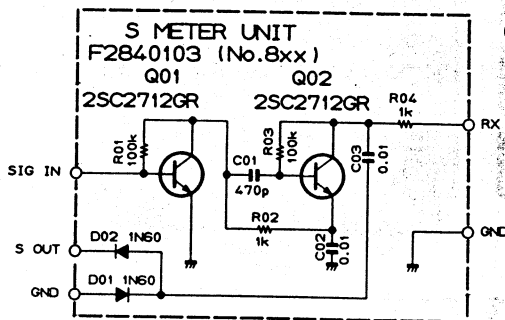

RESISTOR VALUES ARE IN Ω , 1/10W;
CAPACITOR VALUES ARE IN μ F, 50V;
UNLESS OTHERWISE NOTED.

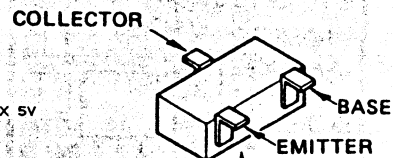

Marked Surface
2SC2712GR (LG)
(Q801,802)

ANT SW UNIT

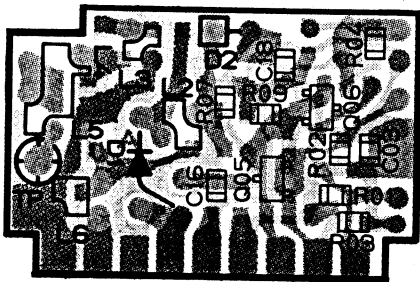

(obverse view of "mixed-component" side)

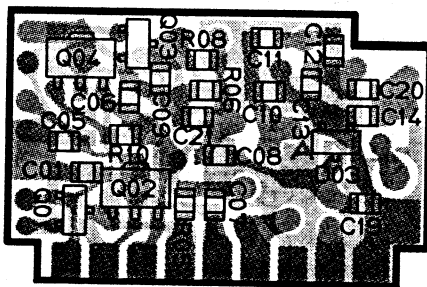

(obverse view of "chip-only" side)

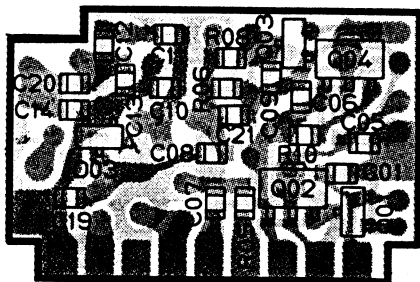

(reverse view of "chip-only" side)

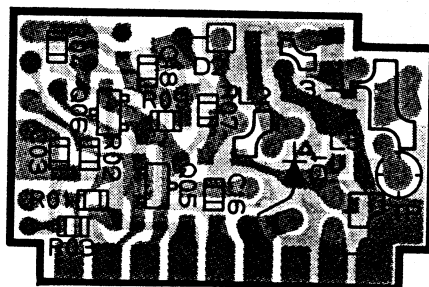

(reverse view of "mixed-component" side)

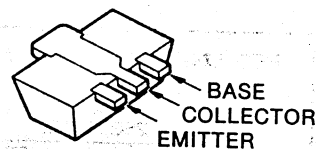

2SB799 (Q902,904)

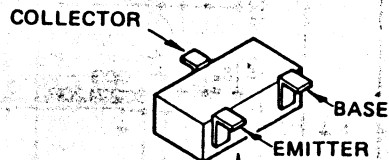

Marked Surface
2SC2712GR (LG)
(Q901,903,905,906)

ANODE 1/CATHODE 2

Marked Surface
1SS226 (C3) : (D903)

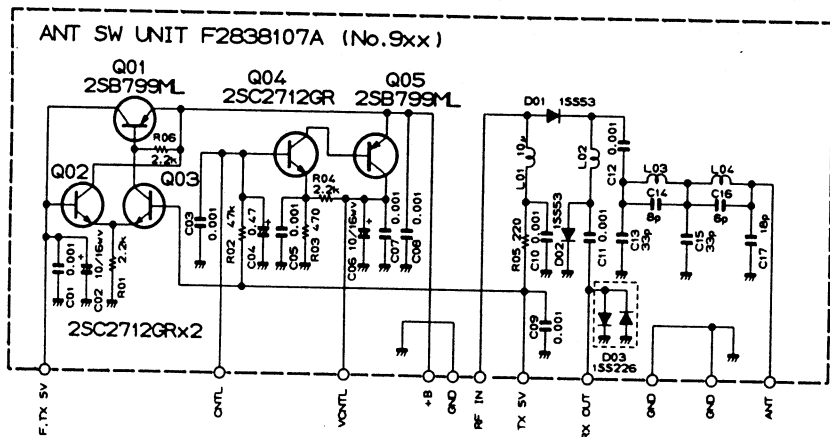

RESISTOR VALUES ARE IN Ω , 1/10W;
CAPACITOR VALUES ARE IN μ F, 50V;
INDUCTOR VALUES ARE IN HENRIES, UNLESS OTHERWISE NOTED.

ERRATA

The schematic diagram of the ANT SW Unit on page 8 is incorrect for the FT-73R. Below is the correct diagram.

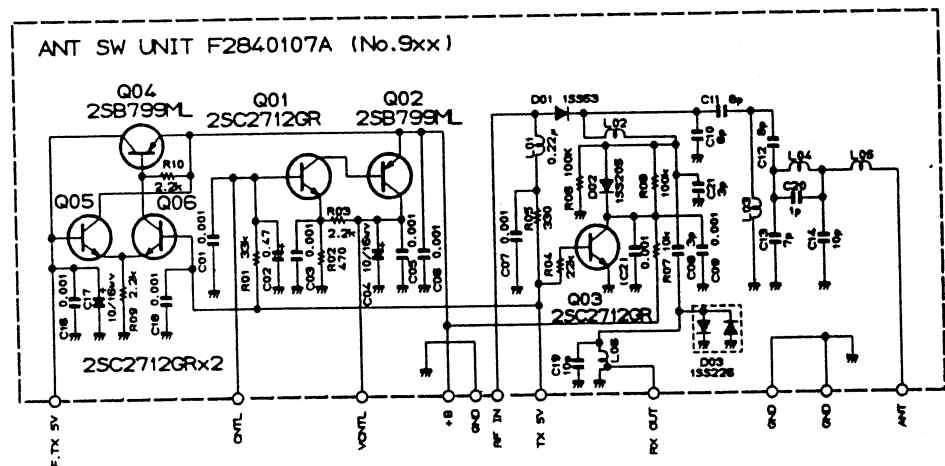

RESISTOR VALUES ARE IN Ω , 1/10V;
 CAPACITOR VALUES ARE IN μ F, 50V;
 INDUCTOR VALUES ARE IN HENRIES, UNLESS OTHERWISE NOTED.

CNTL UNIT

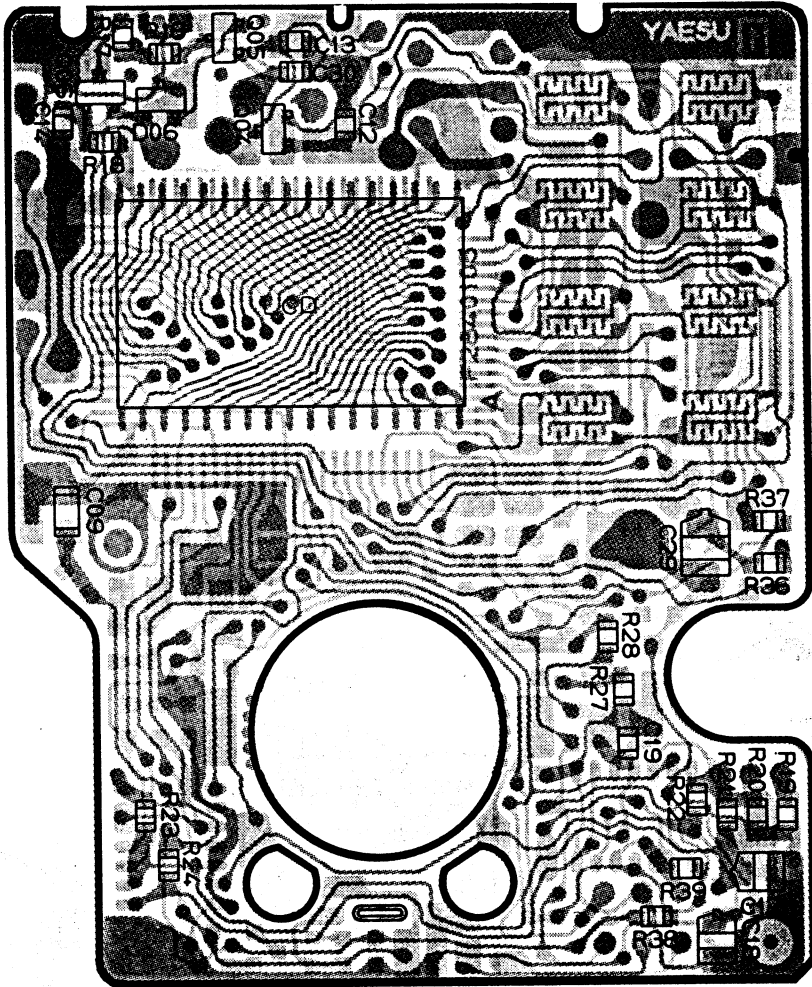

(obverse view of "display" side)

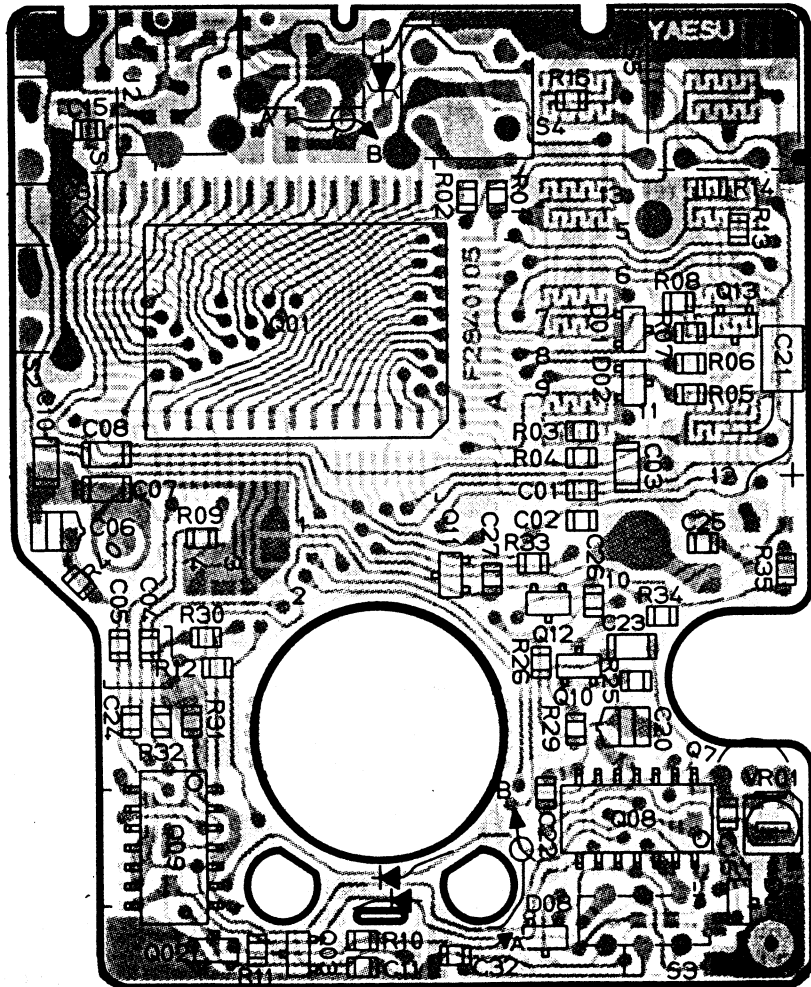

(reverse view of "microprocessor" side)

CNTL UNIT

RESISTOR VALUES ARE IN Ω , 1/10W;
CAPACITOR VALUES ARE IN μ F, 50V;
UNLESS OTHERWISE NOTED.
(*) CAPACITORS ARE TANTALUM, 16V.

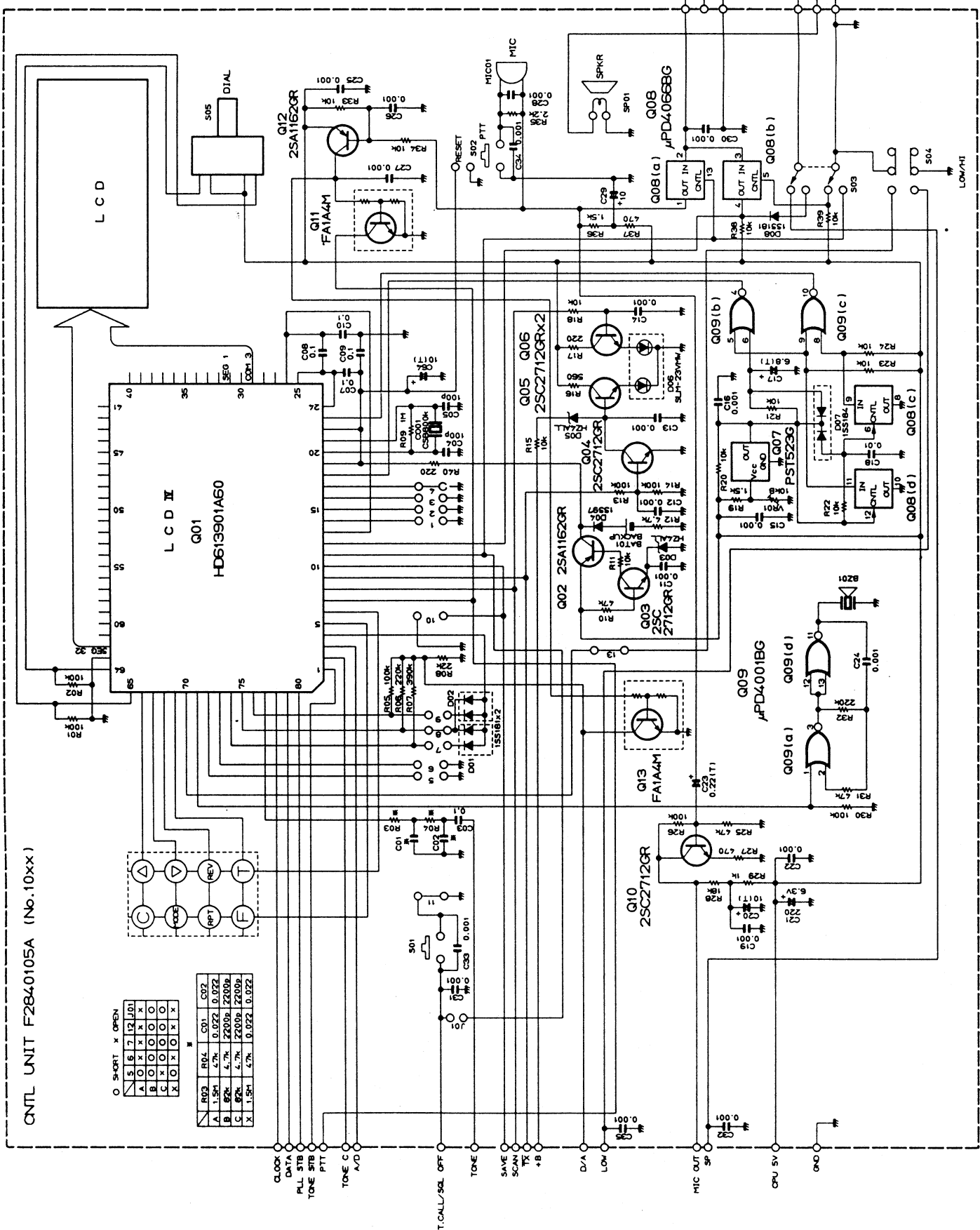

CNTL UNIT F2840105A (No.10xx)

ALIGNMENT

The FT-73R has been carefully aligned by highly skilled technicians at the factory, and is designed so that no further alignment should ever be required. However, in the unlikely event of a component failure, realignment may be necessary. All component replacement and service should be performed only by an authorized Yaesu representative, or the warranty policy may be voided.

The following test equipment is required for alignment:

RF Signal Generator: calibrated output level at 450 MHz

Deviation Meter (linear detector)

Oscilloscope

AF Millivoltmeter

SINAD Meter

Inline Wattmeter: 450 MHz

Regulated DC Power Supply: adjustable from 4 to 17V, 2A

50-ohm Non-reactive Dummy Load: 10W at 450 MHz

Frequency Counter: 0.2ppm accuracy at 450 MHz

AF Signal Generator

DC Voltmeter: high impedance

CASE DISASSEMBLY

1. Make sure the transceiver is off. Remove the hard or soft case, if used, and remove the battery pack.
2. Remove the four screws affixing the battery spring plate on the bottom of the transceiver, and carefully remove the plate.
3. Remove the four screws affixing the top panel, and carefully remove the panel.
4. Remove the two screws affixing the front and rear halves of the case, and gently separate the halves, using care not to stress the interconnecting wires.

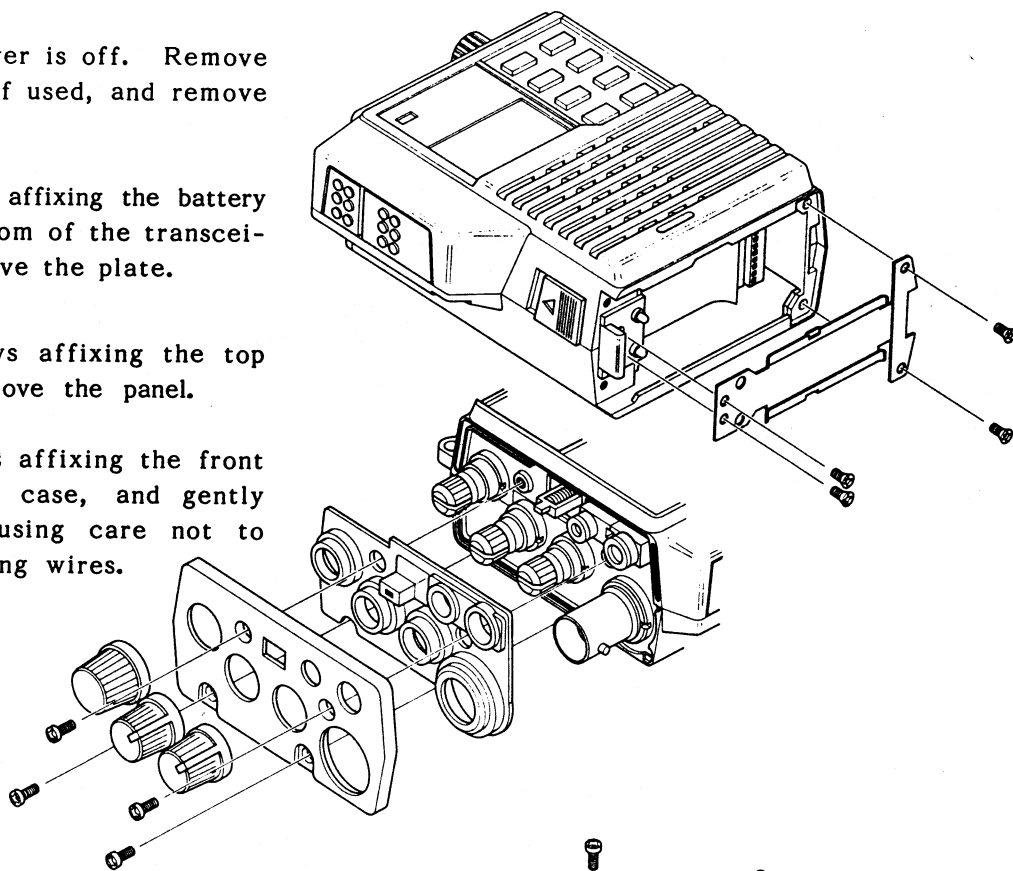

BOARD LAYOUT

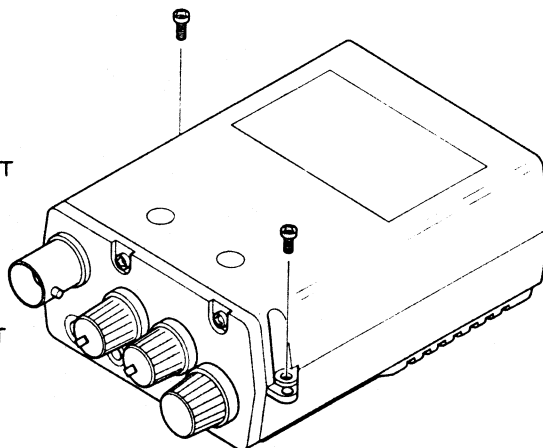
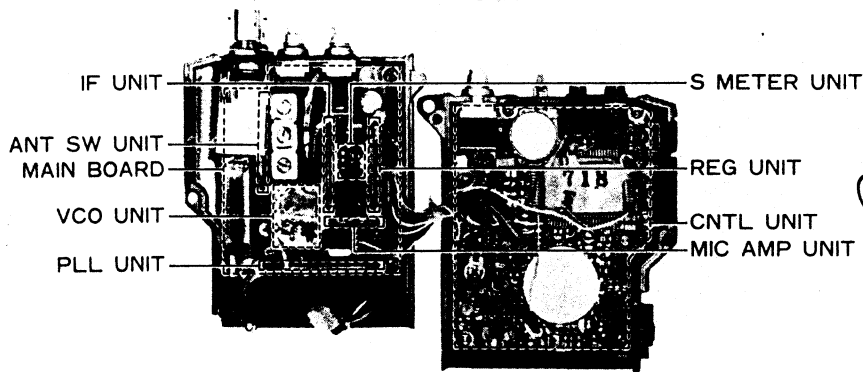

I. PLL & TRANSMITTER

Set up the test equipment as shown in the diagram below for transmitter alignment. Adjust the supply voltage to 12.0V for all steps except Transmitter Output Power alignment (B).

A. PLL VCV (Varactor Control Voltage)

- (1) Connect the DC voltmeter between the hot end of C416 on the PLL Unit and chassis ground.
- (2) While transmitting on the low band edge (430 or 440 MHz) adjust trimmer TC502 on the VCO Unit for 1.0 ± 0.1 VDC.
- (3) While receiving on the same frequency, adjust trimmer TC501 on the VCO Unit for 1.0 ± 0.1 VDC.
- (4) Repeat steps (2) and (3) several times.
- (5) Retune the transceiver to the high end of the band (440 or 450 MHz) and confirm 2 and 3 VDC on the meter.

B. Transmitter Output Power

- (1) Tune the transceiver to band center (145 or 146 MHz), and set the LOW switch to the undepressed position.
- (2) Increase the supply voltage to 12.5V.
- (3) Adjust TC101 on the Mother Board for peak output power on the wattmeter (at least 5W with less than 1.5A supply current).
- (4) Press the LOW switch on the top panel, and adjust VR105 on the Mother Board for 0.5 watts output.
- (5) Return the supply voltage to 12.0V.

C. PLL Reference Frequency

With the transceiver tuned to band center (145 or 146 MHz), adjust TC401 on the PLL Unit, if necessary, so that the display frequency matches the frequency counter when transmitting.

D. Modulation Level

- (1) With the transceiver tuned to band center (145 or 146 MHz), adjust the AF generator for 25mV output at 1 kHz to the MIC jack.
- (2) Adjust VR104 on the Mother Board for ± 4.5 kHz deviation on the deviation meter.

PLL & TRANSMITTER ALIGNMENT SETUP

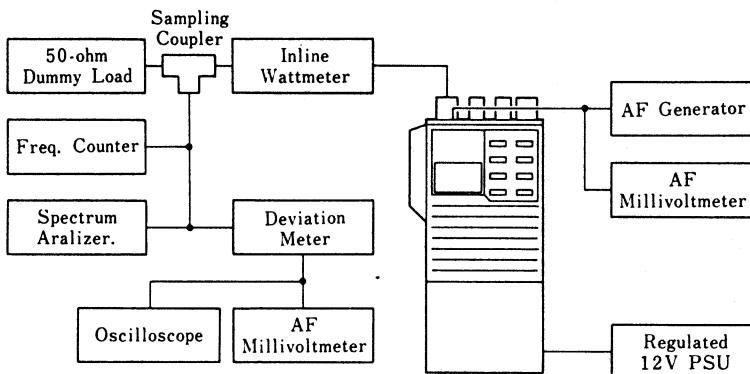

PLL & TRANSMITTER ALIGNMENT POINTS

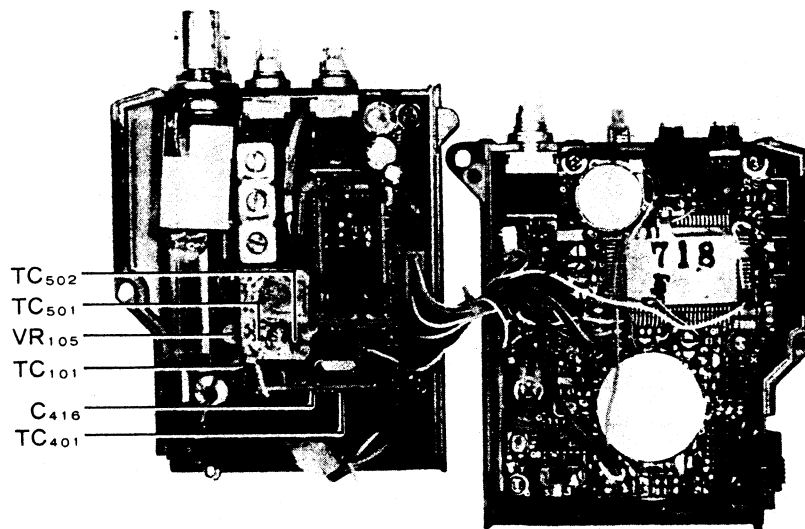

II. RECEIVER

Set up the test equipment as shown below for receiver alignment.

A. Sensitivity

- (1) With the transceiver and RF signal generator both tuned to band center (145 or 146 MHz), set the generator for ± 3.5 kHz deviation of 1 kHz tone modulation, and set the output level for 20 dBu at the antenna jack.
- (2) Alternately expand and compress the turns of coil L906 on the ANT SW Unit to obtain peak S-meter indication.
- (3) Reduce the signal generator level while observing the SINAD meter for 12 dB SINAD, and then confirm that the generator level is below -6dBu (0 dBu = 0.5 μ V).
- (4) Retune the transceiver and generator to the high band edge (440 or 450 MHz) and repeat step (3), spreading the turns of L906 slightly if sensitivity is too low.
- (5) Retune the transceiver and generator to the low band edge (430 or 440 MHz) and repeat step (3), compressing the turns of L906 slightly if sensitivity is too low.
- (6) Repeat steps (4) and (5) for best overall sensitivity.

B. S-meter Sensitivity

- (1) With the transceiver and RF signal generator set up as in step (1) of the above Sensitivity adjustment procedure, set the signal generator for 20 dBu output.
- (2) Adjust VR103 on the Mother Board so that all bargraph segments are just turned on.
- (3) Reduce the generator output so that only two bargraph segments are on, and confirm that the generator output level is now 5 dBu or less.

RECEIVER ALIGNMENT SETUP

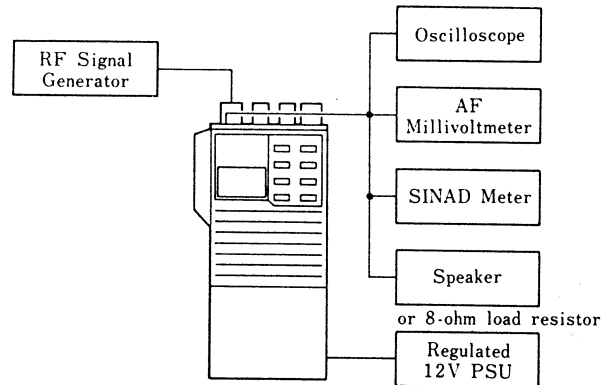

RECEIVER ALIGNMENT POINTS

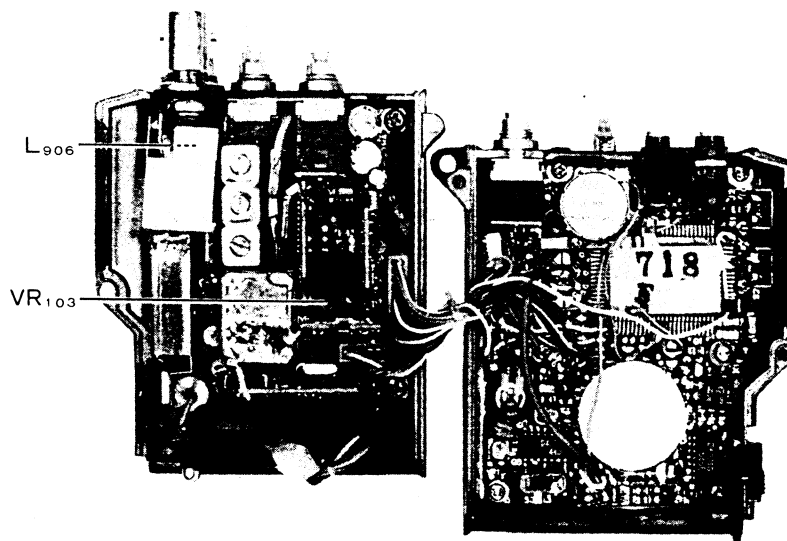

PARTS LIST

MAIN CHASSIS					CRYSTAL FILTER
Symbol No.	Part No.	Name & Description	XF101	H1102101	17M15BU 17.2MHz
		CAPACITOR			
C1	K00173070	Ceramic disc 50WV 7pF SL (DD104SL070D50)			CERAMIC FILTER
C2,3	K10176102	" " " 0.001μF B (DD104B102K50)	CF101	H3900280	LF-B12
					RESISTORS
		CONNECTOR	R122,126	J24205000	RMC 1/10T000J 1/10W 0Ω
J01	P1090541	BNC-RM	R120	J24205479	" " 479J " 4.7Ω
			R114,121	J24205150	" " 150J " 15Ω
			R108,117	J24205220	" " 220J " 22Ω
			R105,113	J24205101	" " 101J " 100Ω
		MISCELLANEOUS	R103	J24205221	" " 221J " 220Ω
	R3116390	DIAL Knob	R118	J24205331	" " 331J " 330Ω
	R3116620	VOL, SQL Knobs	R102	J24205471	" " 471J " 470Ω
	R3508300	PTT Button Cover	R123	J24205102	" " 102J " 1kΩ
	R3508310	UNLOCK Lever	R119	J24205122	" " 122J " 1.2kΩ
	R0117370	Coil Spring	R106	J24205272	" " 272J " 2.7kΩ
	R0507950B	Battery Spring Plate	R112	J24205562	" " 562J " 5.6kΩ
	R3503650A	Top Panel Gasket	R116	J24205223	" " 223J " 22kΩ
	R3507960	Jack Seal Gasket	R124	J00215223	Carbon film 1/8W 22kΩ VJ
			R107,115	J24205333	RMC1/10T333J1/10W 33kΩ
			R101	J24205823	" " 823J " 82kΩ
			R109-111,125	J24205104	" " 104J " 100kΩ
			R104	J24205394	" " 394J " 390kΩ
MOTHER BOARD					
Symbol No.	Part No.	Name & Description			
	F2840104A	Printed Circuit Board			POTENTIOMETERS
	C028404AA	PCB with Components Model A	VR101	J60800128	K091K0004-20KB 20kΩ B
	C028404AB	" " "	VR102	J60800129	K0911100D-20KA 20kΩ A
		" B	VR103-105	J51776473	RH0411CS4J 47K 47kΩ
	C028404AC	" " "			
		" C			
	C028404AD	" " "			CAPACITORS
		" X	C106	K22170201	Chip Ceramic 50WV 0.5pF CH (C2012CH1HOR5CFA)
	C028404AE	" " "	C103	K22170205	" " " 4pF "
		" F			(C2012CH1H040CFA)
			C109	K22170208	" " " 7pF "
					(C2012CH1H070DFA)
		IC	C101,128	K22170209	" " " 8pF "
Q103	G1090558	LA4145			(C2012CH1H080DFA)
			C108	K22170213	" " " 12pF "
					(C2012CH1H120JFA)
			C127	K22170215	" " " 15pF "
		POWER MODULE			(C2012CH1H150JFA)
Q109	G1090733	M57797MA	C102,104,105,112 123,126,129-131 133-137,139,140 142-145	K22170805	" " " 0.001μF B (C2012B1H102MFA)
		TRANSISTORS	C146	K10176102	" " " 0.001μF "
Q101,102	G3333567	2SC3356-T2B			(DD104B102K50)
Q104	G3111627G	2SA1162GR-TE85R	C107,138	K22170817	" " " 0.01μF "
Q105	G3327127G	2SC2712GR-TE85R			(C2012B1H103MFA)
Q106	G3070001	FA1A4M	C132	K22171006	" " " 0.022μF F
Q107	G3335857	2SC3585-T2B			(C2012F1H223ZFA)
Q108	G3329547	2SC2954-T2B	C121	K22171008	" " " 0.047μF "
					(C2012F473ZFA)
			C110,111,113,116 120	K22141904	" " 25WV 0.1μF D (C3216D1E104MFA)
		DIODE	C122	K78130001	Chip Tantalum 20WV 0.47μF (F951D474MRAA1Q2)
D101	G2090277	1SS205			

C114,119,124	K40129052	Electrolytic 16WV 10 μ F (RC3-16V100M)			DIODES
			D301,302	G2070007	1SS226TE85L
C115,125	K40129038	" " 100 μ F (RC2-16V101M)			
C117,118	K40089020	" 6.3WV 100 μ F (RC3-6V101M)	X301	H0102777	CRYSTAL UM-1 16.745MHz
		TRIMMER CAPACITOR			CERAMIC DISCRIMINATOR
TC101	K91000100	ECR-GA020E30 20pF	CD301	H7900260	D455C
		INDUCTORS			RESISTORS
L101	L1190291	LAL02NA4R7K 4.7 μ H	R305	J24205101	RMC 1/10T 101J 1/10W100 Ω
L102	L1690001	LQN2A10NM 0.01 μ H	R304	J24205471	" " 471J " 470 Ω
L103	L0020875A		R311	J24205152	" " 152J " 1.5k Ω
L104	L0021532		R301,307,308	J24205222	" " 222J " 2.2k Ω
			R314	J24205392	" " 392J " 3.9k Ω
			R315	J24205472	" " 472J " 4.7k Ω
			R313	J24205682	" " 682J " 6.8k Ω
		CAVITIES	R309,316	J24205103	" " 103J " 10k Ω
CV101 Model A	L4020065	NK-6041-44	R303,310	J24205473	" " 473J " 47k Ω
CV101 Models B, C,X,F	L4020066	NK-6041-435M	R306	J24205104	" " 104J " 100k Ω
			R302	J24205224	" " 224J " 220k Ω
			R312	J24205474	" " 474J " 470k Ω
		CONNECTORS			
	P0090599	IL-Y-5P-S15T2-EF			CAPACITORS
J101	P0090601	IL-Y-14P-S15T2-EF	C303	K22170215	Chip Ceramic 50WV 15pF CH (C2012CH1H150JFA)
J102	P0090598	IL-Y-4P-S15T2-EF			" " " 56pF "
J103	T9205436		C304,310	K22170229	(C2012CH1H560JFA)
P101(with wire)					" " " 120pF "
			C305	K22170237	(C2012CH1H121JFA)
		CORE	C309	K22170239	" " " 150pF "
	L9190045	FR6.3X3.0X2.2			(C2012CH1H151JFA)
			C302,306,314	K22170805	" " " 0.001 μ F B (C2012B1H102MFA)
			C301,312,317	K22170817	" " " 0.01 μ F "
		FERRITE BEADS			(C2012B1H103MFA)
	L9190001	4A R13X3-1	C307,308,313	K22141904	" " 25WV 0.1 μ F D (C3216D1E104MFA)
					Chip Tantalum 10WV 1 μ F (F951A105MRAAF1Q2)
			C316,318	K78120013	" " 6.3WV 15 μ F (F950J156MVCAF1Q2)
			C311	K78080004	
IF UNIT					
Symbol No.	Part No.	Name & Description			
	F2840102	Printed Circuit Board			
	C028402AA	PCB with Components			INDUCTOR
			L301	L1190343	LAL02KR4R7K 4.7 μ H
		IC			
	G1090698	TK10420M			
Q302					
					PLL UNIT
			Symbol No.	Part No.	Name & Description
		TRANSISTOR		F2840108A	Printed Circuit Board
	G3326207B	2SC2620QBTR		C028408AA	PCB with Components Model F
Q301				C028408AB	" " " Model A.X.B.C

		ICs			TRANSISTORS
Q401	G1090708	MC12018	Q501-503	G3333567	2SC3356-T2B
Q402	G1090582	JLC1007P			
					DIODES
D401	G2090027	DIODE 1SS53 Si	D501,502	G2070035	1T32-T8
					RESISTORS
		CRYSTALS	R512	J24205150	RMC1/10T 150J 1/10W 15Ω
X401*	H0102775	UM-1 10,240MHz	R502	J24205470	" " 470J " 47Ω
X401▲	H0102776	UM-1 12,800MHz	R510	J24205681	" " 681J " 680Ω
			R503,508	J24205222	" " 222J " 2.2kΩ
			R509	J24205472	" " 472J " 4.7kΩ
			R501,504-507	J24205103	" " 103J " 10kΩ
		RESISTORS	R511	J24205683	" " 683J " 68kΩ
R408	J24205150	RMC 1/10T150J 1/10W 15Ω			
R402,403	J24205220	" " 220J " 22Ω			
R405	J24205221	" " 221J " 220Ω			
R407	J24205222	" " 222J " 2.2kΩ			
R406	J24205103	" " 103J " 10kΩ			
R404	J24205223	" " 223J " 22kΩ			
					CAPACITORS
			C506,511	K22170202	Chip Ceramic 50WV 1pF CH (C2012CH1H010CFA)
			C513	K22170203	" " " 2pF " (C2012CH1H020CFA)
			C512	K22170204	" " " 3pF " (C2012CH1H030CFA)
C401	K22170204	Chip Ceramic 50WV 3pF CH (C2012CH1H030C50)	C507	K22170208	" " " 7pF " (C2012CH1H070DFA)
C412	K22170223	" " " 33pF " (C2012CH1H330JFA)	C509	K22170209	" " " 8pF " (C2012CH1H080DFA)
C411	K22170227	" " " 47pF " (C2012CH1H470JFA)	C501	K22170310	" " " 9pF UJ (C2012UJ1H090DFA)
C408-410	K22170235	" " " 100pF " (C2012CH1H101JFA)	C510	K22170219	" " " 22pF CH (C2012CH1H220JFA)
C402,403,405,407 413-415	K22170805	" " " 0.001μF B (C2012B1H102MFA)	C502,504,505,508	K22170805	" " " 0.001μF B (C2012B1H102MFA)
C416,417	K22141904	" " 25WV 0.1μF D (C3216D2E104MFA)	C503	K78080002	Chip Tantalum 6.3WV 4.7μF (F950J475MSAAF1Q2)
C404,406	K78080002	Chip Tantalum 6.3WV 4.7μF (F950J475MSAAF1Q2)			
C418	K78100003	" " 10WV 6.8μF (F951A685MTAAF1Q2)			
					TRIMMER CAPACITORS
			TC501,502	K91000153	TZB04Z030BA 3pF
		TRIMMER CAPACITOR			
TC401	K91000154	ECR-KN020E11 20pF			CERAMIC RESONATOR
			L501	H7900320	DRS064UE190P
		INDUCTOR			
L401	L1190311	LAL02NA221K 220μH			TERMINAL POSTS
				Q5000082	IPS-1091
				R0116640A	SHIELD CASE
				R0117110	SHIELD LID
				R0117120A	SHIELD REAR
VCO UNIT					
Symbol No.	Part No.	Name & Description			
	F2840106	Printed Circuit Board			
	F2840110	" " "			
	C028406AB	PCB with Components			

* Model F
▲ Model A,X,B,C

REG UNIT			RESISTORS		
Symbol No.	Part No.	Name & Description			
			R705	J24205332	RMC 1/10T332J1/10W3.3kΩ
	F2840109A	Printed Circuit Board	R710	J24205562	" " 562J " 5.6kΩ
	C028409AA	PCB with Components	R701 [▲] , 702 [▲] , 709	J24205103	" " 103J " 10kΩ
			711-713		
			R704,708	J24205333	" " 333J " 33kΩ
			R701*	J24205473	" " 473J " 47kΩ
		IC	R707	J24205563	" " 563J " 56kΩ
Q604	G1090736	LVC550C-2	R702*	J24205683	" " 683J " 68kΩ
			R715,716	J24205104	" " 104J " 100kΩ
			R703,714	J24205225	" " 225J " 2.2MΩ
			R706	J24205335	" " 335J " 3.3MΩ
		TRANSISTORS			
Q601	G3207997L	2SB799MB			
Q602,603,608	G3327127G	2SC2712GRTE85R			
Q605-607	G3111627G	2SA1162GRTE85R			
					CAPACITORS
			C705,708,710	K22170805	Chip Ceramic 50WV 0.001μF B (C2012B1H102MFA)
			711,713,714		
			C703 [▲]	K22170809	" " " 0.0022μF B (C2012B1H223MFA)
		DIODES			
D601,604	G2090027	1SS53 Si	C702 [▲] , 703*, 709	K22170817	" " " 0.01μF " (C2012B1H103MFA)
D602	G2090183	HZ9A2L Zener			
D603	G2070009	1SS184TE85R Si	C706	K22171008	" " " 0.047μF F (C2012F1H473ZFA)
			C702*	K22141004	" " " 25WV 0.068μF " (C2012F1E683ZFA)
		RESISTORS			
			C701,704,707,712	K22141904	" " " 0.1μF D (C3216D1E104MFA)
R602	J01245829	Carbon Film 1/4W 8.2Ω TJ			
R601	J24205101	RMC 1/10T101J 1/10W 100Ω			
R608	J24205222	" " 222J " 2.2kΩ			
R606,607,612	J24205472	" " 472J " 4.7kΩ			
R605,611	J24205103	" " 103J " 10kΩ			
R603	J24205223	" " 223J " 22kΩ			
R604,609,610	J24205104	" " 104J " 100kΩ			
					S METER UNIT
			Symbol No.	Part No.	Name & Description
				F2840103	Printed Circuit Board
				C028403AA	PCB with components
		CAPACITORS			
C601,603,604,606 608-613	K22170805	Chip Ceramic 50WV 0.001μF B (C2012B1H102MFA)			
C605	K78120002	Chip Tantalum 16WV 2.2μF (F951C225MSAAF1Q2)			
C602	K78100003	" " 10WV 6.8μF (F951A685MTAAF1Q2)	Q801,802	G3327127G	2SC2712GRTE85R
C607	K78080003	" " 6.3WV 10μF (F950J106MTAAF1Q2)			
					TRANSISTORS
					DIODES
			D801,802	Q2090029	1N60 Ge
					RESISTORS
			R802	J24205102	RMC 1/10T 102J 1/10W 1KΩ
	F2840101	Printed Circuit Board	R804	J01245102	Carbon film 1/4W 1KΩ TJ
	C028401AA	PCB with Components Models A,X,F	R801,803	J24205104	RMC 1/10T 104J 1/10W 100KΩ
	C028401AB	" " " Models B,C			
					CAPACITORS
			C801	K22170801	Chip Ceramic 50WV 470pF B (C2012B1H471MFA)
		IC			
Q701	G1090726	M5224FP	C802,803	K22170817	" " " 0.01μF B (C2012B1H103MFA)

* Models A,X,F
▲ Models B,C

ANT SW UNIT			CNTL UNIT		
Symbol No.	Part No.	Name & Description	Symbol No.	Part No.	Name & Description
	F2840107A	Printed Circuit Board		F2840105A	Printed Circuit Board
	C020487AA	PCB with Components		C028405AA	PCB with Components Model F
				C028405AC	" " " Model A,X
		TRANSISTORS		C028405AD	" " " Model B,C W/O BAT
Q901,903,905,906	G3327127G	2SC2712GRTE85R			
Q902,904	G3207997L	2SB799ML			
		DIODES			ICs
D901	G2090027	1SS53 Si	Q1001	G1090758	HD613901A60
D902	G2090277	1SS205 Si	Q1007	G1090752	PST523G
D903	G2070007	1SS226 TE85R Si	Q1008	G1090602	μPD4066BG
			Q1009	G1090601	μPD4001BG
		RESISTORS			TRANSISTORS
R905	J24205331	RMC 1/10T331J 1/10W 330Ω			
R902	J24205471	" " 471J " 470Ω	Q1002,1012	G3111627G	2SA1162GRTE85R
R903,909,910	J24205222	" " 222J " 2.2kΩ	Q1003-1006,1010	G3327127G	2SC2712GRTE85R
R907	J24205103	" " 103J " 10kΩ	Q1011,1013	G3070001	FA1A4M
R904	J24205223	" " 223J " 22kΩ			
R901	J24205333	" " 333J " 33kΩ			
R906,908	J24205104	" " 104J " 100kΩ			
					DIODES
			D1001,1002,1008	G2070001	1SS181TE85R Si
			D1003,1005	G2090334	HZ4ALL Zener
		CAPACITORS	D1004	G2090118	1SS97 Schottky
C920	K22170202	Chip Ceramic 50WV 1pF CH (C2012CH1H010CFA)	D1006	G2070028	SLM-23VMW T-97 LED
C908,921	K22170204	" " " 3pF " (C2012CH1H030CFA)	D1007	G2070009	1SS184TE85R Si
C910	K22170207	" " " 6pF " (C2012CH1H060DFA)			
C913	K22170208	" " " 7pF " (C2012CH1H070DFA)			RESISTORS
C911,912	K22170209	" " " 8pF " (C2012CH1H080DFA)	R1017,1040	J24205221	RMC 1/10T 221J 1/10W220Ω
C914,919	K22170211	" " " 10pF " (C2012CH1H100DFA)	R1027,1037	J24205471	" " 471J " 470Ω
C901,903,905-907 909,916,918	K22170805	" " " 0.001μF B (C2012B1H102MFA)	R1016	J24205561	" " 561J " 560Ω
C902	K40179033	Electrolytic 16WV 0.47μF (RC3-50VR47M)	R1029	J24205102	" " 102J " 1kΩ
C904,917	K40129052	" " " 10μF (RC3-16V100M)	R1019,1036	J24205152	" " 152J " 1.5kΩ
			R1035	J24205222	" " 222J " 2.2kΩ
			R1004 [▲] ,1012,1020 1038	J24205472	" " 472J " 4.7kΩ
			R1011,1015,1018 1021-1024,1033 1034,1039	J24205103	" " 103J " 10kΩ
			R1028	J24205183	" " 183J " 18kΩ
			R1008	J24205223	" " 223J " 22kΩ
			R1004*,1010,1025 1031	J24205473	" " 473J " 47kΩ
		INDUCTORS	R1003 [▲]	J24205823	" " 823J " 82kΩ
L901	L1190342	LAL02KRR22M 0.22μH	R1001,1002,1005 1013,1014,1026 1030	J24205104	" " 104J " 100kΩ
L902,903	L0021531				
L904,905	L0020875A				
L906	L0021263		R1006,1032	J24205224	" " 224J " 220kΩ
			R1007	J24205394	" " 394J " 390kΩ
			R1009	J24205105	" " 105J " 1MΩ
			R1003*	J24205155	" " 155J " 1.5MΩ
		TERMINAL POSTS			
TP901	Q5000016	TP-E			
					POTENTIOMETER
			VR1001	J51771103	RVG4F03103TG 10kΩ

* Models A,X,F

▲ Models B,C

CAPACITORS			RUBBER CONDUCTOR	
C1004,1005	K22170235	Chip Ceramic 50WV100pF CH (C2012CH1H101JFA)	S2000026	24.3x1.8x1 SS
C1011-1016,1019 1022,1024-1027 1030-1032	K22170805	" " " 0.001μF B (C2012B1H102MFA)		
C1028,1033-1036	K10176102	Ceramic disc " 0.001μF " (DD104B102K50)	Q9000366	LITHIUM BATTERY CR2025
C1001 [▲] ,1002 [▲]	K22170809	Chip Ceramic " 0.0022μF " (C2012B1H222MFA)		
C1018	K22170817	" " " 0.01μF " (C2012B1H103MFA)	G6090060	LIQUID CRYSTAL DISPLAY LR541-C
C1001*,1002*	K22170821	" " " 0.0022μF " (CM21W5R223M50VAT)		
C1003, 1007-1010	K22141904	" " 25WV 0.1μF D (C3216D1E104MFA)		
C1023	K78160027	Chip Tantalum 35WV 0.22μF (TESVA1V224M1-8R)	L9190001	FERRITE BEADS 4A RI3x3-1
C1017	K78100003	" " " 6.8μF (F951A685MTAAF1Q2)		
C1020, 1029	K78080003	" " 6.3WV 10μF (F950J106MTAAF1Q2)		
C1006	K70087106	Tantalum 6.3WV 10μF (DN0J100MIS)		
ACCESSORIES*				
		Symbol No.	Part No.	Name & Description
				ANTENNA
			Q3000050	YHA-46
CONNECTORS				
P1001(With wire)	T9205435A			
P1002*(With wire)	T9205433		S6000098	HAND STRAP
P1002 [▲] (With wire)	T9205434			
CERAMIC RESONATOR				
X1001	H7900270	CSB800K	D3000493	FNB-10
BUZZER				
BZ1001	M4290001	EFBRE-25D02	D3000477 D3000504	VINYL SOFT CASE* CSC-23 u/w FNB-10 CSC-25 u/w FNB-10, FTT-4
SPEAKER				
SP1001	M4090063	TO36S13Y2611		* Optional same models
MIC				
MIC1001	M3290008	EM-78C YE		
SWITCHES				
S1001, 1002	N5090018	KHH15951 SQL OFF*. BURST [▲] . PTT		
S1003	N6090063	SSSS22050A		
S1004	N4090088	SPJ622NO9 HI/LO		
S1005	N0190139	SRBMIL066 DIAL		
CONNECTORS				
J1001	P1090369	HSJ0838-01-010 MIC		
J1002	P1090370	HSJ0836-01-010 EAR		

* Models A,X,F
[▲] Models B,C

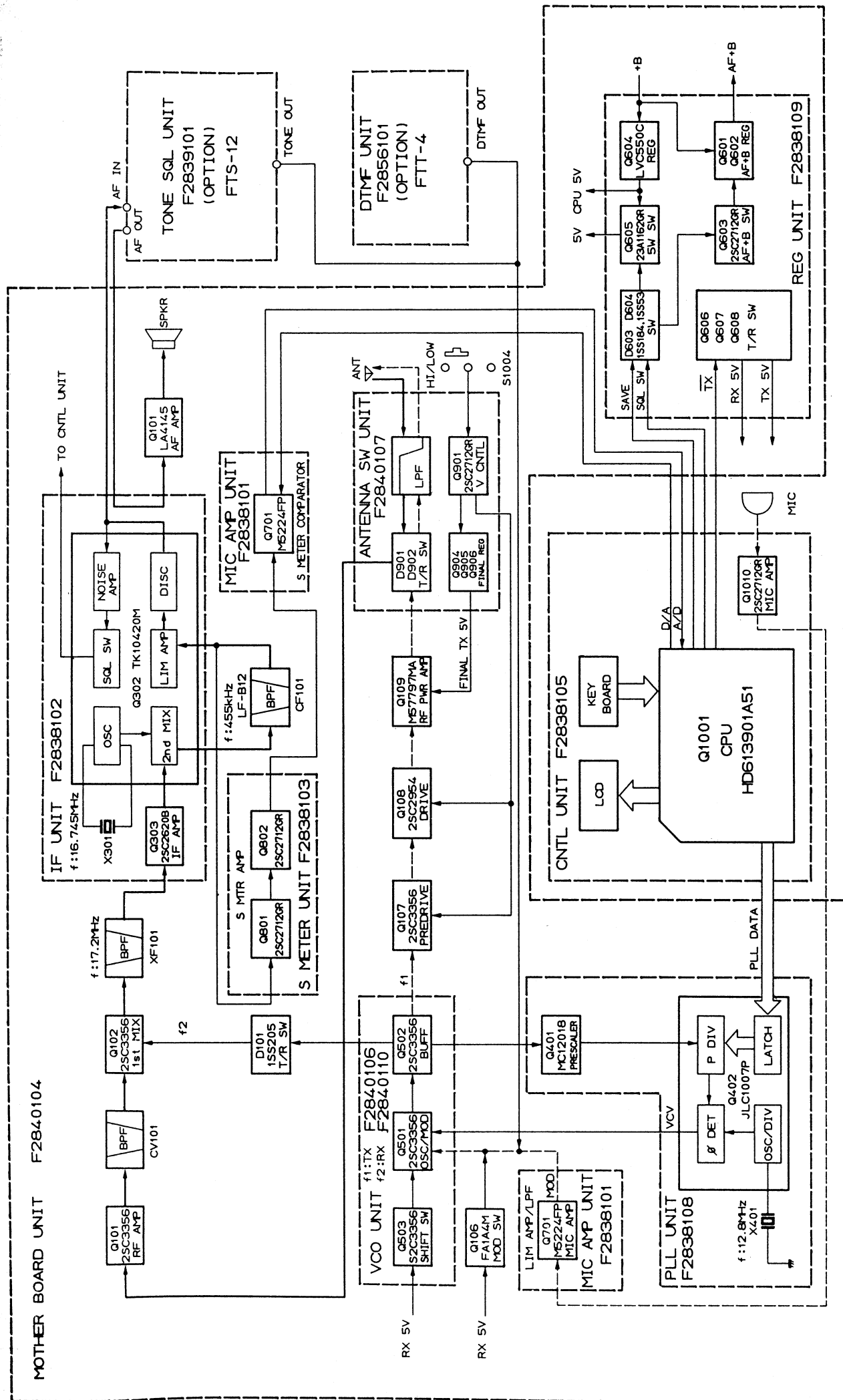

FT-73R
BLOCK DIAGRAM

——— RECEIVE
 - - - TRANSMIT
 ····· COMMON/CNTL

	A	B.C.X
f1	440-450MHz	430-440MHz
f2	422.8-432.8MHz	412.8-422.8MHz