

YAESU

FT-5100

*Dual-Band 2m/70cm
Mobile Transceiver*



FT-5100 Features

The FT-5100 is a mobile dual-receive and cross-band full duplex amateur transceiver descending directly from the FT-5200, including most of its features and adding some of its own. Miniaturization technology allows a built-in antenna duplexer, dual full-frequency liquid crystal display (with signal strength bargraph for each display channel), 8-level automatic display/button lighting dimmer, and now dual receive capability on two channels on different bands, or *in the same band*. An efficient thermally-switched cooling fan allows up to 50 watts VHF and 35 watts UHF output.

Ninty-four freely tunable memories (forty-seven per band) offer complete programmability and scanning functions, such as independent transmit and receive frequencies, programmable repeater offsets and two scan ranges on each band, selectable scan resume modes and memory skip, priority monitoring and 1-touch instant-recall CALL channels for each band. Channel steps are user-selectable, and Automatic Repeater Shift can be activated to automatically set standard repeater shifts when tuning to repeater subbands (where applicable). Versions are available with microphone button control of a 1750-Hz burst generator (with the MH-26D8 or MH-26E8 Speaker/Mic), VFO/memory or band selection.

The MW-1 *Wireless* Microphone/Controller option duplicates the controls (including volume and squelch), adding a DTMF (Dual-Tone, Multi-Frequency) keypad and microphone. You can select a 3-digit ID code and your receiver stays quiet until your code is received (from *any* DTMF-equipped transceiver). You can also have a code open the squelch or a ring like a telephone. PAGE mode displays the caller's code so you know who is calling. One-touch paging transmits paging codes whenever the PTT switch is pressed, if desired. Four banks of seven 3-digit code memories each store your ID plus that of the calling station and those of five other stations or groups for calling/monitoring (autopatching requires the MH-26F8 or MH-27B8 DTMF keypad microphone, or the MH-15D8 with its own auto-dial DTMF memories). A 38-tone programmable CTCSS (Continuous Tone-Coded Squelch System) encoder is built-in, and CTCSS tone squelch operation on both receiving channels is available with the FTS-22 Dual Band CTCSS Decoder option, which also provides a telephone-type CTCSS Bell alerting function.

Please read this manual before installing or operating the FT-5100.

Contents

Accessories	1		
Specifications	2	Recalling Memories	19
Front Panel Controls	3	<i>Alternating Band Memory Selection</i>	19
Rear Panel Connectors	6	Call Channel Memories	20
Installation	7	Separate Transmit Frequency Memories	20
Antenna Considerations	7	Memory Tuning	21
Mobile Installation	7	<i>Hiding and Erasing Memories</i>	21
<i>External Speakers</i>	9	Scanning	21
<i>Other Mobile Accessories</i>	9	<i>Memory Skip Scanning</i>	22
Base Station Installation	9	Programmable Subband Limits	22
Operation	10	Priority Channel Monitoring	24
Preliminary Setup	10	CTCSS (Subaudible Tone) Operation	25
Important Terms	11	<i>CTCSS Bell Paging with the FTS-22</i>	26
Squelch Setup	12	DTMF Paging & Code Squelch	27
Main Channel Band Selection	13	<i>DTMF Code Squelch</i>	27
Frequency & Step Selection	13	<i>DTMF Paging</i>	28
Dual-Channel Receive	13	<i>Storing Code Memories</i>	29
<i>Selective Channel Receiver Muting</i>	15	<i>Responding to a DTMF Page, and Resetting</i>	30
<i>Single-Band/Dual-Channel Functions</i>	15	In Case of Problems	32
Transmitting	15	<i>Resetting the CPU</i>	33
<i>Repeater Splits</i>	16	Memory Backup	33
<i>Setting Standard Repeater Offset</i>	17	Memory Cloning	34
<i>Automatic Repeater Shift</i>	17	Packet Radio TNC Interconnections	35
Storing Memories	18	FTS-22 Tone Squelch Unit Installation	36

Accessories

The FT-5100 is supplied with a DC Power Supply Cable, Mobile Mounting Bracket, and one of the microphones from the following list. Other items may be supplied per local requirements.

Model	Description	Order Code
AD-3	VHF/UHF Duplexer for 2-Ant Operation	A02200001
	DC Power Supply Cable (2.8 meters)	T9015605
FP-700	Power Supply for AC Mains Operation	A625501-X
FTS-22	Dual-Band Tone Squelch Unit	A02970002
MH-26D8	Hand Microphone w/1750 Hz Burst Button	A04230001
MH-26E8	Hand Speaker/Mic w/1750 Hz Burst	A04240001
MH-26F8	Hand Microphone w/DTMF Keypad	A04250001
MH-27A8J	Hand Microphone w/DTMF Keypad	A04270001
MH-15D8	Hand Microphone w/DTMF Memory Keypad	D1000061
MF-1A3B	Boom Microphone w/Flexible Arm	D1000044
MMB-37	Quick-Release Mobile Mounting Bracket	D6000056
MW-1	Remote Wireless Controller/DTMF Microphone	A02980002
SB-10	PTT Switch Unit for MF-1A3B or YH-1	D3000396
SP-7	External Loudspeaker	A03590001
YH-1	Headset	D3000262

Specifications

General

Frequency Range: see Version Chart below
 Channel Steps: 5, 10, 12.5, 15, 20, 25 & 50 kHz
 Frequency Stability: $< \pm 5$ ppm from -5 to $+50$ °C
 Mode of Emission: F3
 Antenna Impedance: 50 ohms, unbalanced
 Supply voltage: 13.8-V DC $\pm 15\%$, neg. ground
 Current Consumption (typical): Rx: 600 mA,
 Tx hi/low: 11.5/4A (2-m), 9/3.5A (70-cm)
 Operating Temp. Range: -20 to $+60$ °C
 Case Size (WHD):
 140 x 40 x 155 mm (w/o knobs)
 Weight: 1 kg (2.2 lb)

Transmitter

Output Power: 50/5W (2-m),
 35/5W (70-cm)
 Modulation Type: Variable Reactance
 Maximum Deviation: ± 5 kHz
 Spurious Radiation: better than -60 dB
 Mic. Impedance: $600\Omega \sim 10k\Omega$

Receiver

Circuit Type: Double Conversion Superhet.
 IF: 455 kHz, and 17.7 (2-m) or 21.7 MHz (70-cm)
 Sensitivity (for 12-dB SINAD): < 0.158 μ V
 Selectivity ($-6/-60$ dB): 12/24 kHz
 Image Rejection: better than 65 dB
 Squelch Sensitivity: at least 0.1 μ V
 Maximum AF Output: 3 W into 4Ω @ 5% THD
 AF Output Impedance: 4~16 Ω (8- Ω int. speaker)

Specifications subject to change without notice or obligation.

Version Chart (○ = no ARS on this band)

Version →	A1	A2	A3	B1	B2	B3	B4	B5	C1	C2	C3	C4	C5	D	H1	H2	H3	H4	H5
VHF Range (MHz)	144 ~ 146			•					•					•	•				
	144 ~ 148	•			•					•						•			
	Rx: 140-174 Tx: 140-150		•				•					•							•
	140 ~ 160							•						•					•
140 ~ 174			•		•						•						•		
UHF Range (MHz)	430 ~ 440			○	○	○	○	○	○	○	○	○	○		○	○	○	○	○
	430 ~ 450	•	•	•															
	432 ~ 438														○				
UHF Rptr Shift (default, MHz)	1.6								○	○	○	○	○	○					
	5	•	•	•											○	○	○	○	○
	7.6				○	○	○	○	○										

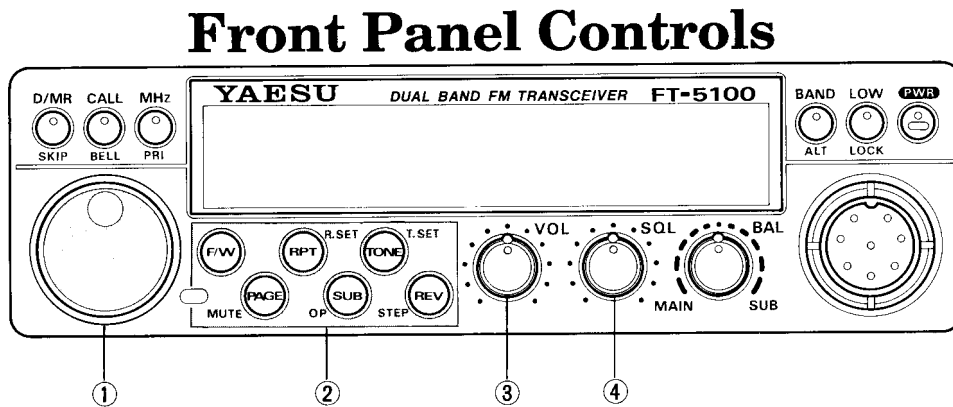

(1) Selector Knob

This 24-position detented rotary switch is used for tuning, memory selection and most function settings. The **DWN** and **UP** buttons on the microphone duplicate the functions of this knob.

(2) Main Function Keys (with white labels)

These six keys select most of the major operating features. If the button beeper is enabled, one or more beeps will sound when a key is pressed, if the resulting command is accepted. The white labels on the keyfaces show the main function of each key. However, if you press the **F/W** key first, these keys will perform alternate functions indicated by the blue label near each key (and described in the *Operation* chapter).

For descriptive purposes in this manual, we refer to alternate key functions by preceding the alternate key name with '**F/W** ⇒' in front of it to remind you to press the **F/W** button first. For example, '**F/W** ⇒ **OP**' indicates that you should press **F/W** followed by the **SUB (OP)** button (within five seconds).

(3) VOL Control

This control adjusts the volume of the receiver audio (both receivers together if dual receive is active), and of the button beeper.

(4) SQL Control

This control sets the threshold level at which a received signal (or noise) opens the squelch and can be heard. For maximum squelch sensitivity set this control from counterclockwise just until noise is

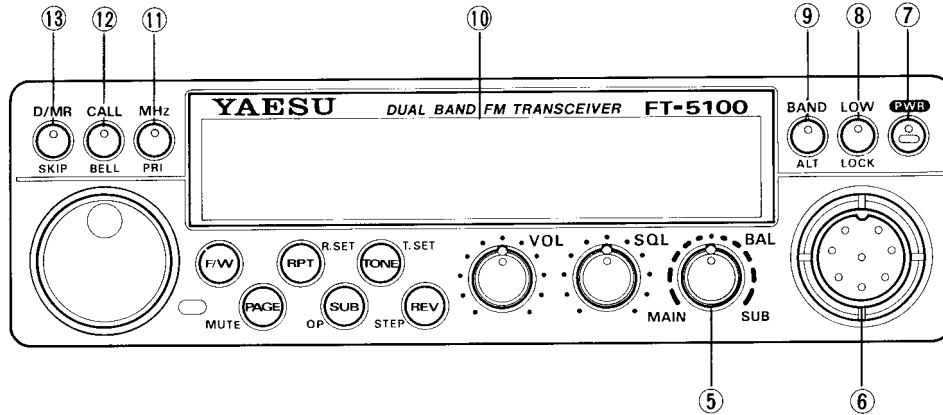

silenced (and the “**BUSY**” indicator on the display is off) when the channel is clear. This control normally affects only the main receiver, but if “**ALT**” is blinking on the display (after pressing **F/W** ⇒ **OP**), it affects the sub receiver instead.

(5) **BAL** Control

This control adjusts the relative balance of receiver audio between the main and sub receivers.

(6) Microphone Jack

This 8-pin jack accepts transmit audio, band selection and scanning control from the microphone, and provides receiver audio (for

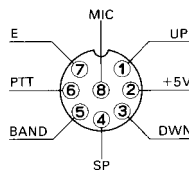

a speaker/mic). Also, memories can be copied between two transceivers through this jack.

(7) **PWR** Button

Press this button to turn on the transceiver. Press and hold it for 1/2 second to turn off the transceiver.

(8) **LOW (LOCK)** Button

Press this button while receiving to toggle high/low transmitter power (50/5 watts on 2-m, 35/5 watts on 70-cm). The display shows “**LOW**” (just above the **VOL** Control) when low power is selected. The alternate function of this button disables the selector knob and most of the front panel keys and buttons (except itself, **F/W** and **PWR**). Press **F/W** and this button again to unlock the panel.

(9) BAND (ALT) Button

This button changes bands: that is, the left (main) and right (sub, if enabled) frequency displays reverse, and the main and sub audio (at the **BAL** control) reverses. The alternate function toggles alternating band memory selection: memory selection and scanning alternate between bands (“**ALT**” appears, not blinking, between the frequencies at the bottom of the display).

(10) Display

The display segments are as shown below. You can check them at any time by switching the transceiver on while holding the **F/W** key.

(11) MHz (PRI) Button

This button allows tuning in 1-MHz steps (the kHz digits blank on the display). If receiving on a memory, pressing this button the first time activates

‘Memory Tuning’ (**MT**) mode, and pressing it again enables 1-MHz steps. The alternate function of this button activates priority monitoring, described in the *Operation* chapter (“**P**” displayed instead of the memory number above and left of the frequency).

(12) CALL (BELL) Button

Press this button to jump to and from your **CALL** channel memory. The alternate function activates the CTCSS bell functions, described later.

(13) D/MR (SKIP) Button

This button switches operation between the two main tuning modes: dial and memory. The alternate function marks the current memory to be skipped during scanning.

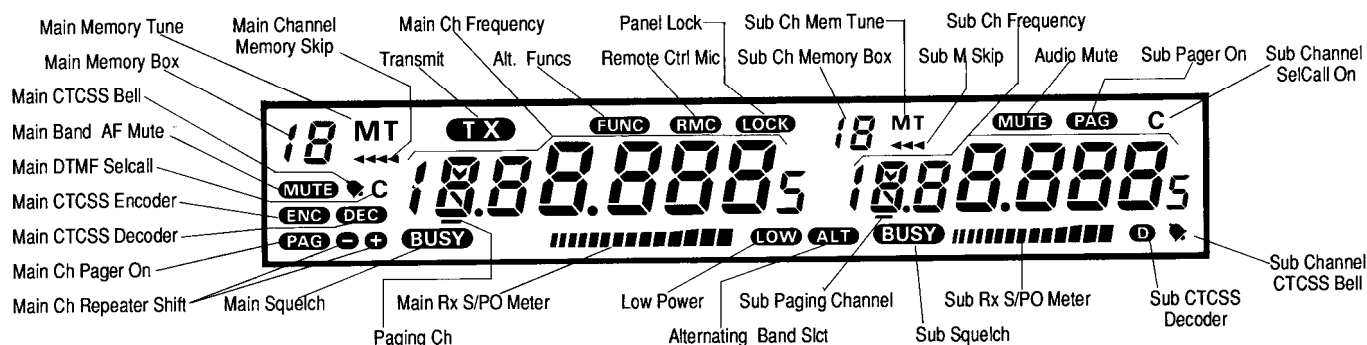

Rear Panel Connectors

(14) 13.8V DC Cable Pigtail w/Fuse

This is the power supply connection for the transmitter. Use the supplied DC cable to connect this pigtail to the car battery or other DC power supply capable of at least 12 Amperes (continuous duty). Make certain that the *red* lead connects to the *positive* side of the supply. See the *Installation* chapter for more details.

(15) DATA IN/OUT & EXT SP Jacks

The 3-contact Data mini phone jack accepts 50-mV_{p-p} AFSK input at the tip contact from a packet TNC for transmission, and provides 400-mV_{p-p} (max.) receiver audio for the TNC on the ring contact. Impedance at both contacts is 50 k Ω , but the tip

contact impedance must be pulled down to 2k ~ 3.3k Ω (by the TNC's PTT control line) to key the transmitter — see the *Packet* chapter near the end of the manual. Unplug the microphone from the front panel when using this jack.

The EXTERNAL SPEAKER 2-contact mini phone jack accepts a 4- to 16-ohm external speaker such as the Yaesu SP-3, SP-4, SP-7 or SP-55. Inserting a plug disables the internal speaker.

(16) ANT Cable Pigtail with Coaxial Socket

Connect a dual-band antenna to this type-N socket using 50-ohm coaxial cable and a type-N plug. Make sure the antenna is designed specifically for use on both bands.

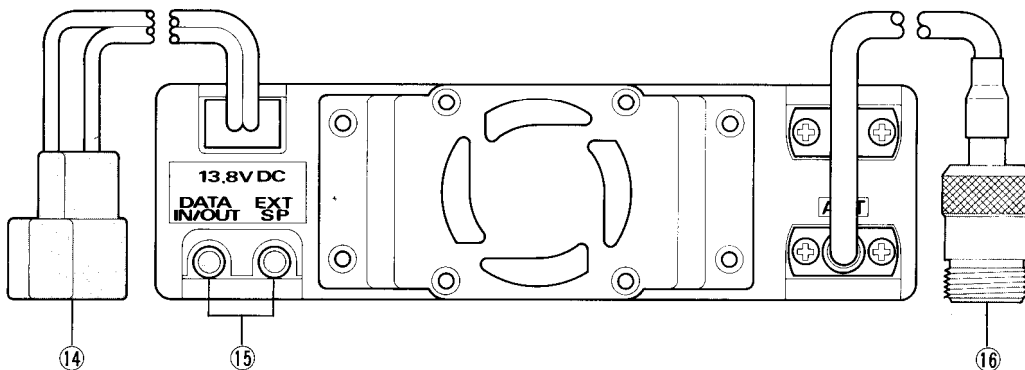

Note: In some versions of the FT-5100, the antenna is a type-M (SO-239, "UHF"). This differs from the description and illustration on pages 6 & 7 of operating manual. Be sure to use a matching type-M (PL-259) plug.

Installation

This chapter describes installation of the FT-5100 with typical supplied accessories. Installation of the FTS-22 CTCSS Decoder Unit is described at the back of this manual. If you have this option and it is not yet installed, turn to *FTS-22 Installation* at the back before installing the transceiver as described below.

Antenna Considerations

The FT-5100 is designed for use with dual-band antennas having an impedance near 50 ohms at all operating frequencies on both bands. For optimum performance use a high quality, carefully designed antenna. The antenna should be connected whenever power is on, to avoid damage that could otherwise result if you transmit accidentally without an antenna.

Make sure your antenna is designed to handle 50 watts continuous transmitter power. You do not need an antenna duplexer for dual-band operation with a dual-band antenna, since one is built into the FT-5100. If you prefer to use two antennas (such as with external power amplifiers), ask your Yaesu dealer for the AD-3 Duplexer option to split the bands for different antennas.

For best performance and safety in mobile installations, mount the antenna in the center of a flat surface, out of reach of human hands: 50 watts can burn anyone touching the antenna during transmission!

For best performance use the shortest possible length of thick, top-quality coaxial cable. Be sure to use a matching type-N plug for the transceiver connection.

Mobile Installation

The FT-5100 must only be installed in cars having a negative ground electrical system. Mount the transceiver where the display, controls and microphone are easily accessible, using the supplied MMB-37 mobile mounting bracket. The transceiver may be installed in any position, but should not be near a heater vent or where it could interfere with driving. Make sure to provide plenty of space at the rear so that air can flow freely through the heatsink, as well as space underneath to allow sound from the internal speaker to be heard. Refer to the diagrams on the next page for installation.

- Decide the mounting location with sufficient clearance for the transceiver, plus space for ventilation around the cooling fan and above and below the set. Use the mounting bracket as a template to locate the mounting holes. Use a 4.8-mm ($\frac{3}{16}$ -inch) bit to drill the holes, and secure the bracket with the supplied screws, washers and nuts (next page, Figure 1).
- Screw the two mounting clips to the sides of the transceiver using the small hex bolts and washers supplied (Figure 2).

To install the transceiver, position it in the bracket so that the clip on the left side fits into the slot in the left side of the bracket (Figure 3), then push the right side of the transceiver upwards until it latches.

To remove the transceiver, place your hand underneath and pull the latch in the right side of the bracket outward so the right side of the transceiver drops free.

Figure 1.

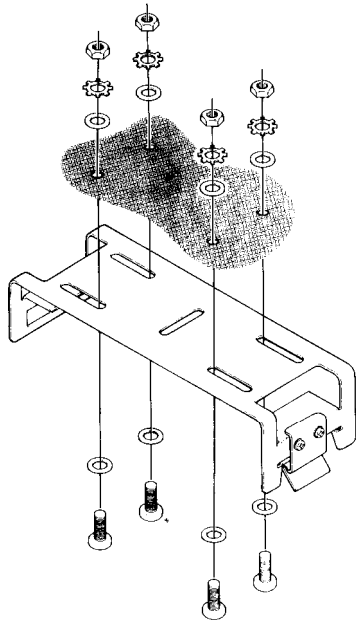

Figure 2.

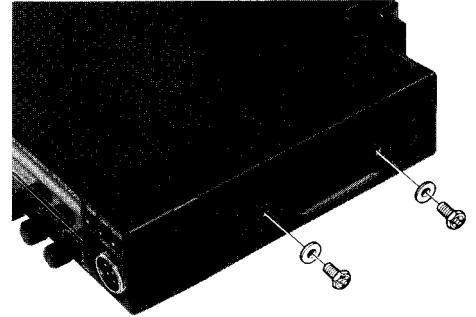
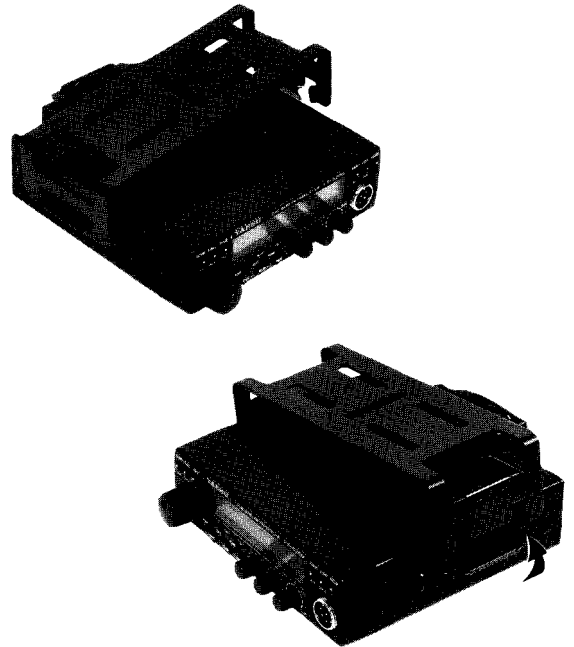

Figure 3.



Warning

Never apply AC power to the transceiver. Never connect DC voltage of more than 15 volts to the power jack. When replacing the fuse, use only a 15-A fast-blow type. Failure to observe these precautions will void the warranty.

Mobile Power Connections

To minimize voltage drop and avoid blowing the car fuses, connect the supplied DC cable directly to the battery terminals. Do not try to defeat or bypass the cable fuse – it is there to protect you and the equipment.

- Connect the RED power cable lead to the POSITIVE (+) battery terminal, and the BLACK lead to the NEGATIVE (–) terminal. If you need to extend the power cable, use #14 AWG or larger insulated, stranded copper wire. Connect the cable to transceiver only after connecting to the battery.

External Loudspeaker

Connecting an external loudspeaker disables the internal speaker. The external speaker duplicates the function of the internal speaker, but lets you to optimize

the location of the audio source for most comfortable reception. The optional SP-7 External Speaker includes its own swivel-type mounting bracket, and is available from your Yaesu dealer. Of course the older SP-3, SP-4 or SP-55 External Speakers may also be used.

Other Mobile Accessories

Other options to enhance safety and mobile operating convenience are the MW-1 Wireless Remote Controller/DTMF Microphone, which duplicates the front panel controls and adds a DTMF keypad; the YH-1 Headset; and the full size MF-1A3B boom microphone with flexible arm (both use the SB-10 PTT switch) allowing practically hands-free operation.

Base Station Installation

Operation from the AC line requires a power supply capable of providing at least 12 A continuously at 13.8-V DC. We recommend using an external speaker, as the internal speaker is on the bottom of the radio. The FP-700 AC power supply/loudspeaker is available from your Yaesu dealer to meet these needs. Use the DC power cable supplied with the transceiver for making power connections, and connect the external speaker cable to the **EXT SP** jack on the rear panel.

Operation

This chapter describes the transceiver functions in detail. After studying these descriptions, keep the *FT-5100 Operator's Quick Reference Chart* handy in case you need to refresh your memory.

Preliminary Setup

Before operating the transceiver, recheck power supply and antenna connections, and connect your microphone (or the module of the MW-1 Wireless Mic) to the front panel jack. Never operate the transceiver without a proper antenna for the operating band. Also, please read the earlier *Front Panel Controls* section, if you have not already, to familiarize yourself with the controls.

The next few pages describe some characteristics of the FT-5100 controls critical to its operation, and some of the terms we will use in later sections.

As mentioned before, references to alternate key/button functions have '**F/W** ⇒' in front of the key/button name to remind you to press the **F/W** key first momentarily, and then the (blue) named key or button within five seconds (while **FUNC** appears in reverse letters above the leftmost frequency on the display). In some cases we will include the 'non-alternate' button name in parentheses after the blue label, just to help you find it (this does not mean you should

Turning Power Off

To turn the transceiver off, you must press *and hold* the **PWR** button for ½ second.

press it twice). Also, don't hold the **F/W** key down, as that will give you a different result. When a button should be held down (as opposed to just pressed momentarily) the instructions will say so.

A five-second timer starts when you press **F/W**, and automatically restarts when you turn the selector knob or press a microphone button. Pressing a key or front panel button shuts off the timer and accepts the change.

Note: The **P** button on the MH-27 microphone is not used by the FT-5100.

A key/button beeper provides useful audible feedback whenever a button is pressed, at a level determined by the volume control. Each key and button has

Beeper Disabling

If you want to turn the beeper off (or back on), you can press **F/W** ⇒ **TONE** and **F/W** ⇒ **TONE** again (each key, twice alternately).

a different beep pitch, and each function has a unique beep combination. For example, when you press the **BAND** button, you will hear a low-pitched beep followed by a high-pitched beep if switching the main channel from 2-m to 70-cm, or a high-pitched beep followed by a low-pitched beep if switching from 70-cm to 2-m. You can disable the beeper as described in the box on the previous page, but we recommend you keep it enabled while getting to know the controls.

If the transceiver doesn't seem to work as described, see *In Case of Problems* on page 32. Also, see the box on page 31 to override auto display dimming.

Important Terms

If the transceiver has not been used before, the display will look something like this:



We call the frequency in larger digits at the left side of the display the *main channel*, and the frequency at the right (if any), the *sub channel*. You can turn the sub channel display on and off (only dashes displayed) by pressing **SUB**. As you might expect, dual receive is active only when a sub channel is displayed at the right.

The **BAND** button selects which band or bands appear in the main and sub channel displays. *Transmis-*

If nothing happens when you press a button, the panel may be “locked” (you normally use this to prevent accidental changes). If you see “LOCK” displayed in reverse letters above the right edge of the main display, press F/W ⇒ LOCK (next to the PWR button) to unlock the panel. Later you can press F/W ⇒ LOCK again to fix your settings and prevent tampering.

sion is possible only on the main channel, but in the FT-5100, you can set both channels to receive different frequencies on the same band simultaneously. Each channel display has its own memory box above and to the left of the frequency, its own busy indicator below left, and its own S&PO meter scale below.

Normally, the selector knob, keys, buttons and **SQL** control affect only the main channel. However, by pressing **F/W ⇒ OP** (the **SUB** key) first so that “ALT” is displayed (blinking) above the **VOL** control, you can cause the controls to act on the sub channel instead. After making adjustments to the sub channel, press the **SUB** key alone to return control to the main channel.

You could, of course, use the **BAND** button to swap main and sub channels and make changes only to the (current) main channel, but this does not work for all functions (like the sub channel squelch setting).

Besides the main and sub channel distinctions, you need to be aware of the two channel selection modes provided for different types of operation:

Dial Mode

This mode is for tuning or scanning the band when looking for a channel on which to operate, when you don't know the specific frequency in advance. In this mode, the selector knob ('dial') and microphone buttons each tune in the selected step size or in 1-MHz steps, and the scanning uses the selected step size. You also need the dial mode, at least initially, to select a frequency to be stored into a memory.

Memory Mode

This mode is mainly for operating only on specific frequency channels known in advance (and programmed into memories). For example, after storing the frequencies of your local repeaters into memories, you can confine operation to those channels by selecting the memory mode. In this mode, the selector knob, microphone buttons and scanning function select sequentially from the stored memories. The FT-5100 gives you 47 memories on each band. There is also a *Memory Tune* mode, in which you can tune just like the dial mode, and store the resulting retuned memory into the same or another memory. This and other special functions that apply to the memory mode are described later, but you will want to keep these terms in mind.

Note that the main and sub channels can each be set to either dial or memory mode independently. You can tell at a glance which selection mode a channel is in by looking in the shaded memory box above and to the left of its frequency display. If the box is empty, you are in the dial mode. If you see a small number or an *L*, *1L*, *U*, *1U* or *C* in the box, that channel is in the memory mode.

The **D/MR** button at the upper left toggles between the dial and memory modes. Press this button alone to toggle the main channel, or after pressing **F/W** ⇒ **OP** to toggle the sub channel.

Squelch Setup

- Preset the **VOL** and **SQL** fully counterclockwise.
- Press the **PWR** button (if the radio is off) and adjust the **VOL** control for comfortable volume on the noise or any received signal. "BUSY" should be displayed in reverse letters to the left of the main channel's **S&PO** meter scale, indicating the squelch is open.
- Press the **D/MR** button, if necessary, to switch the main channel to the dial mode (memory box blank).
- If you hear a signal turn the selector knob to a clear frequency (only noise).
- Turn the **SQL** clockwise just to silence the noise. The BUSY indicator will disappear (setting the **SQL** further clockwise reduces sensitivity to weak signals). Whenever a signal reaches the receiver that is strong enough to open the squelch, BUSY will be displayed.

Keep in mind that there are two independent squelch settings in the FT-5100 — one for each channel.

With those preliminaries out of the way, let's explore some major operating features.

Main Channel Band Selection

Press the **BAND** button above the microphone jack to select the desired band for the main channel (at the left), and adjust the squelch if you hear noise. Sub channel band selection is described later.

Frequency & Step Selection

After selecting the band, select the MHz range in which you wish to operate: press the **MHz** button above the selector knob, and then turn the knob. The MHz digits will blink while MHz tuning is enabled. For fine tuning, press **MHz** again so the MHz digits stop blinking, or just wait five seconds, and then turn the selector knob. Normally the tuning step size will have been preset for your area. If not, you can change the step size as described in the box on this page.

You also can use the UP/DWN buttons on the microphone to select your operating frequency. However, holding one of these buttons for more than 1/2 second starts the scanner. This is described later, but if you've already started it, press a mic button again to stop.

Channel Step Selection

Tuning steps are factory preset to the correct size for the country to which the FT-5100 is exported. To change to another step size, press **F/W** ⇒ **REV** and use the selector knob or microphone buttons to select a different step (5, 10, 12.5, 15, 20, 25 or 50



kHz). The "5" or "P" in the memory box is the scan mode indicator, described later. Once the desired step size is displayed, press **REV** to return to the operating frequency display.

Dual Band Receive

The **SUB** key (lower center of the 6-key group) allows you to control the sub channel. During the above squelch setting, band and frequency selection procedures, you may have seen the sub channel frequency displayed at the right, or you may have seen "----". If only the main channel is displayed, you can press **SUB** to display (and receive on) the sub channel. You can also hide the sub channel and operate the FT-5100 as a single-channel transceiver, as described later.

Sub Channel Settings

When you press **SUB** to display the sub channel, it is initially set to the opposite band from the main channel. With this dual-band display, pressing **BAND** simply swaps the two channels (and bands). To change only the sub channel band, *hold F/W* for ½ second, and then press **BAND**.

Example: set the main channel to 146.94 MHz, and the sub channel to 145.52 MHz.

- Press the **BAND** button, if necessary, to select the 2-m band for main channel, and tune the display to 146.94.
- If no sub channel frequency is displayed, press **SUB** to display the sub channel. It will initially be on the 70-cm band.
- Press *and hold F/W* for ½ second: a second beep will sound, and a number will appear blinking in the memory box at the upper left corner (for 5 seconds). While the blinking number is displayed, press **BAND**. The two channel displays should now match.
- Press **F/W** ⇒ **OP**, and then tune the dial for 145.52 on the sub channel.

As suggested in this example, with both channels displayed you can perform most operations on the sub channel (without having swap it to main), using the alternate (blue **OP**) function of the **SUB** key. For example, to set the sub channel's squelch just press **F/W** ⇒ **OP** first. **ALT** appears blinking near the bottom center

of the display, and turning the squelch control now affects only the sub channel.



Note! The blinking **ALT** remains on the display, and control remains with the sub channel, until you specifically turn it off: to return control to the main channel, press **SUB** once momentarily.

By first displaying **ALT** as above, most of the functions described in the following pages can be done on the sub channel as well. However, the functions listed below disable the **F/W** ⇒ **OP** selection of the sub channel while they are active:

- Single-receiver operation (when “- - -” is displayed at the right).
- During repeater offset, ARS, step, or tone setting.
- During Scan Mode setting.
- While scanning.

Also note that exchanging main and sub channels with the **BAND** button cancels the blinking **ALT** function, if it was active.

The FT-5100 combines receiver audio from both channels when both are active, so you can listen for a call on one channel while monitoring or working stations on the other. After setting the **VOL** control, use the

BAL control to adjust the relative audio levels of the two channels as desired. We recommend setting the **BAL** control slightly to the left of center during dual-channel reception, so signals on the main channel will be a little louder, to help you distinguish signals on each channel by ear.

Selective Channel Receiver Muting

If during dual-channel reception you want one channel to take priority over the other (having signals on one channel attenuate audio of the other so signals from the two channels don't 'double'), press **F/W** ⇒ **MUTE**: once to mute the sub channel, or twice (both keys) to mute the main channel. "**MUTE**" appears either above the sub frequency, or to the left of the main frequency, according to which channel is muted. When you receive signals on both channels simultaneously, the muted channel's audio is suppressed by signals on the other channel. However, when the unmuted channel is quiet, the other is heard at full volume.

Single-Band/Dual-Channel Functions

If you have tried the above example you may have noticed that, when both channels are set to the same band, the functions of the **SUB** and **BAND** buttons are a bit different from when each channel is set to a different band:

- **SUB** swaps the two channels (on the same band – if **ALT** is blinking, press **SUB** twice), and

- **BAND** causes both channels to switch together to the alternate band.

To return only the sub channel to the alternate band, hold **F/W** for $\frac{1}{2}$ second, and then press **BAND**. The main channel is unaffected by this operation, but the frequency that the sub channel was on before changing bands is lost.

Transmitting

Press the **LOW** button above the mic jack to select 5-watt output (**LOW** appears at the bottom center of the display when low power is selected). When you wish to transmit, wait until the channel is clear (**BUSY** not displayed), and squeeze the PTT switch on the microphone. During transmission, **TX** appears above the main frequency, and the main S&PO bar graph shows relative transmitter power output (4 segments for low power, full-scale for high). Release the PTT switch to receive.

If you require more power press the **LOW** button again (to switch to high power). However, we recommend using low power whenever possible, to minimize possible interference, current consumption and heating.

If using a European version, press the **BURST** button on the MH-26A8 microphone to transmit a 1750-Hz Burst Tone to access repeaters that require it.

During dual-channel reception, you can transmit only on the main channel. If the sub channel is set to the

alternate band, reception there is not interrupted. This capability allows full duplex cross-band operation when you and the station you are working are tuned to the same frequencies (on both bands). However, if both channels are on the same band, the sub receiver will be disabled while transmitting (to prevent overload).

If you want to call or respond to a station on the sub channel during dual-receive operation, you must first swap the main and sub channels. If both channels are on the same band, you must press **SUB**. Otherwise, if the channels are on different bands, press **BAND**.

Repeater Splits

The FT-5100 offers three methods to set up split frequency operation for repeaters: manual, automatic and independently stored transmit/receive frequencies. Both manual and automatic methods shift the transmit frequency above or below the receive frequency by a programmable offset. This offset is preset at the factory to 600 kHz for the 2-m band, and either 1.6, 5 or 7.6 MHz on the 70-cm band (depending on transceiver version). Note that only one offset at a time can be used on each band with the manual and automatic methods. Use the independent transmit frequency method when you want to store other offsets, such as frequencies of repeaters with non-standard splits. This is described later under *Separate Transmit Frequency Memories*.

To activate the standard shift manually, just press the **RPT** key: once for minus shift, again for plus shift,

and again to return to simplex. A small ‘-’ or ‘+’ sign will appear at the bottom of the display just above and a little to the left of the key when minus or plus shift is selected, respectively.

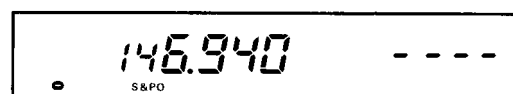

Example: To use a 146.34/146.94 MHz repeater:

- Press the **BAND** button, if necessary, to select the 2-m band as the main channel, and tune the display to 146.94 MHz (to receive on the output frequency).
- Press **RPT** once. A ‘-’ should appear near the lower left corner of the display (if not keep pressing **RPT** until it does).
- When the channel is clear, press the PTT switch on the microphone and send your callsign. The display should shift to 146.34 MHz while you transmit.

Of course this example only works if the offset for 2-m is set to 600 kHz, as supplied from the factory. If it is not, you can change it as described next.

With repeater split activated, you can temporarily reverse the transmit and receive frequencies by pressing the **REV** key. Use this to display the transmit frequency without transmitting, and to check the strength of signals on a repeater uplink frequency. The repeater shift sign blinks while reverse split is selected. Press **REV** again to return to the normal shift direction.

Setting Standard Repeater Offset

As just mentioned, repeater offset is preset to match the requirements of the country to which the FT-5100 is exported. If you need to change the offset:

- Set the main channel to the band for the new offset (sub channel splits can also be set, but will be lost when switching between dual and single band).
- Press **F/W** ⇒ **R.SET** (the **RPT** key) to display the current offset. Standard repeater shift (in MHz, to three decimal places) appears in place of the main frequency.
- Select the desired offset with the selector knob or mic UP/DWN buttons and, if needed, the **MHz** button.



- Press the **RPT** key to return the main display to the operating frequency.

You probably want to keep the repeater offset programmed to the split most commonly used in your area.

Automatic Repeater Shift

The ARS (Automatic Repeater Shift) feature in the FT-5100 activates repeater offset automatically whenever you tune to a standard repeater subband. In

Europe, there is only one: minus shift between 145.6 and 145.85 MHz. In America, there are five on VHF, and two on UHF (plus shift between 442 and 445 MHz, and minus between 447 and 450 MHz).

With this feature enabled, a small '-' or '+' at the bottom left indicates that repeater shift is active (on the main channel), and closing the push-to-talk switch changes to the (shifted) transmit frequency.

The ARS function is disabled at the factory. To enable it on the main channel:

- Press **F/W** ⇒ **R.SET** to display the ARS status (and repeater shift offset) in place of the main frequency. With this display, an '**A**' appears in the memory box when ARS is enabled.

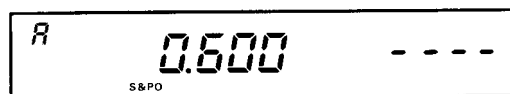

- Now you can press the **F/W** button (alone) to toggle ARS on and off for the main channel.
- Press the **RPT** key alone to return the display to the main frequency.

As already mentioned, you can use the manual shift method (**RPT** key) at any time to select a new shift state, whether ARS is activated or not. However, if you change frequency with ARS activated, manual repeater shift selections are cancelled.

Storing Memories

The FT-5100 provides four banks of 23 memories (two banks per band), plus one CALL channel on each band, for a total of 94 memories. The memories in each of the four banks are labelled 1 ~ 19, L, 1L, U and 1U. All memories can store different receive and transmit frequencies or repeater shift, and CTCSS tone data. This section describes the general purpose functions of the banked memories. The L, 1L, U and 1U memories can also be used to store programmable subband limits, as described later. The box below describes memory bank switching.

To store a frequency in memory:



- Select the desired frequency (and repeater split manually, if desired) in the dial mode as already described.
- Press and hold the **F/W** key for ½ second. A memory number or letter appears blinking in the memory box for the selected band.
- Within five seconds of pressing **F/W**, use the selector knob or microphone UP/DWN keys to select the desired memory for storage. If you select one that was already being used, it will be overwritten with the new data in the next step.

Memory Bank Switching

If you travel a lot, or just want to monitor many channels, you will find the two memory banks on each band particularly convenient when combined with dual-receive operation on a single band. For travellers, the two banks (on each band) can be used to store the different sets of channels used in different areas. When moving from one area to another, both banks can be monitored, and switched with just a few button presses.

Setting the main channel to one memory bank and the sub channel to the other bank on the same band also provides spectacular monitoring capabilities. By

scanning on both main and sub receivers you can check two frequencies at the same time, and when scanning pauses on one receiver, the other continues to scan.

To select the alternate memory bank for the current band, hold the **F/W** key for ½ second so a memory indicator blinks in the memory box, and then press the **D/MR** button. A symbol sort of like '∩' or '∪' appears briefly in the memory box to indicate which bank is selected. Of course, when ALT is blinking, this will affect the sub channel instead of the main channel. Scanning is described later.

- Press **F/W** again, this time momentarily, to store the displayed data into the selected memory. The memory label will stop blinking for a second, and then disappear as operation continues in the dial mode.

Example: Store 146.34/146.94 in memory 5.

- First perform the steps in the example on page 16 to set up the desired frequency and offset on the dial.
- Press and hold the **F/W** key for $\frac{1}{2}$ second to display the memory label in the main memory box at the left, then do the next step within 5 seconds.
- Turn the selector knob, if necessary, so that '5' (the memory number to store) shows in the memory box.
- Press **F/W** again, momentarily. That's it. The dial data has been stored in memory 5 for the 2-m band, and you are left operating on the dial.

To confirm that this worked, turn the selector knob to change the dial frequency (to anything), then press **D/MR** to change from dial to memory mode. The numeral 5 should appear in the memory box, and 146.94 (the receive frequency) should appear on the display. Press **REV** once to confirm the transmit frequency of 146.34 MHz, and again to return to normal.

You can use any memory (except C, the CALL channels) with the same result. The two CALL memories require a slightly different procedure.

Notice that pressing **D/MR** from the dial mode always recalls the last stored or used memory.

Recalling Memories

In confirming the results of the last example, we used the **D/MR** button to change from the dial mode to the memories after they were stored. The memory label appears in the memory box at the upper left corner of the (main or sub) frequency display whenever operating on a memory.

When more than one memory has been stored, you can select a memory for operation with either the selector knob or the microphone UP/DWN buttons. If you use the microphone buttons, press and release the button for each memory: if you hold the button down for $\frac{1}{2}$ second, memory scanning starts.

Alternating Band Memory Selection

If you want to select among previously stored memories on both bands, press **F/W** \Rightarrow **ALT** (the **BAND** button) to activate alternating band memory selection. "ALT" will be displayed (not blinking) at the bottom of the display above the **VOL** control, and memory selection will alternately select memories stored on each band, as pictured below. If both channels are displayed, both will toggle alternating memories together.

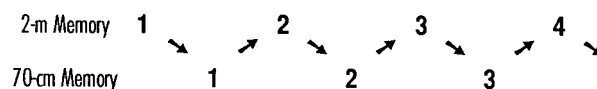

This feature is convenient for memory scanning both bands, described later, but it is disabled when both main and sub channels are set to the same band.

To cancel Alternating Band Memory Selection press **BAND** to remain operating on the memory, or **D/MR** to revert the main channel to the dial mode.

Call Channel Memories

Although invisible to the memory recall methods just described, the CALL channel memory on each band can be instantly recalled by the **CALL** button (for the main channel), or **F/W** ⇒ **OP** and then **CALL** for the sub channel. “C” appears in the corresponding memory box. The factory default for the CALL channel memory is the bottom edge of the band. You can reprogram it from the dial with any frequency and repeater state, or even a separate transmit frequency.

To store the current dial frequency/repeater state in the CALL channel memory of the main channel, hold the **F/W** key for ½ second to display something (blinking) in the memory box, then press the **CALL** button. To store a separate transmit frequency in the CALL channel, after storing the receive frequency, tune the dial to the transmit frequency and repeat the above, but this time holding the **PTT** while you press the **CALL** button.

To store the sub display data into that band’s CALL channel, just press **F/W** ⇒ **OP** to activate the alternate band functions before following the same steps above.

Note that there is only one CALL channel for each band (*not* one for each memory bank).

Separate Transmit Frequency Memories

Besides the two CALL memories, all other memories can store independent receive and transmit frequencies. To do this:

- Store the receive frequency using the method already described under *Storing Memories* (it doesn’t matter if a repeater offset is active).
- Tune to the desired transmit frequency.
- Press and hold the **F/W** key for ½ second to display the blinking label in the memory box again.
- Press and hold the **PTT** switch while pressing **F/W** once more momentarily (this will not key the transmitter).

Whenever you recall a separate transmit frequency memory on the main channel, “-+” appear together near the lower left corner of the display. Again, you can press the **REV** key to display the transmit frequency, and the shift symbols will blink while reversed.

After storing a memory with a separate transmit frequency, if you rewrite the receive frequency, the separate transmit frequency is deleted.

Memory Tuning

While receiving on a recalled memory (but *not* with Alternating Band Selection activated), you can retune it and change other memorized settings, like repeater shift, by first pressing the **MHz** button momentarily. “**MT**” appears to the right of the memory label in the memory box, and you can tune in the same ways as described before (including the 1-MHz button). You can store the new frequency and settings in the current, or another memory, the same as if you were using the dial mode. Just press and hold **F/W** for ½ second, select a new memory (if desired), and press **F/W** again momentarily. Operation remains on the (new) memory as the old memory, if different, reverts to its original state.

After retuning a memory, if you don’t want to save your changes, just press **D/MR**: once to return to the original memory data, or twice if you want to leave the memories and return to the dial mode.

Hiding and Erasing Memories

As already mentioned, storing data in a memory automatically overwrites previously stored data. However, even with two banks on each band, you may not always want to use the same memories in a bank. With the FT-5100, you can select and alter which memories are available without having to rewrite them from scratch. This is done by masking certain memories so that they are hidden from operation, and unmasking them only when desired.

To mask a memory,

- Recall the memory to be masked.
- Press the **F/W** key for ½ second (until the memory label blinks).
- Press the **REV** key. This causes the display to change to memory 1, and the previously selected memory to be no longer selectable manually, or by scanning (described later).

To unmask a hidden memory for operation,

- Recall any memory.
- Press and hold the **F/W** key for ½ second.
- Select the memory number to be restored.
- Press the **REV** key (*not F/W!*).

When you have hidden some memories, be careful not to overwrite them accidentally. If you do, you will lose the previous contents.

Scanning

Before starting the scanner, make sure the **SQL** control is set to squelch off the noise on a clear channel. You start and stop scanning with the **UP** or **DWN** keys on the microphone. Just press and hold the button for more than ½ second to start the scanner. If the transceiver is in the dial mode, band scanning will result. Otherwise, if a memory label is displayed, only the memories in the current bank will be scanned (on both

bands alternately if alternating band memory selection is active).

Scanning pauses when a signal opens the squelch, and the decimal point on the display blinks.

You can choose scan-resume modes: either *pause* mode, in which the scanner pauses for as long as the carrier keeps the squelch open; or the *5-second* mode, in which the scanner pauses for five seconds and then resumes scanning whether the signal is still present or not. The 5-second mode is the factory default.

To change the scan-resume mode, press **F/W** ⇒ **STEP**. A small "P" or "5" in the memory box indicates the current mode. If you want to change it, press **F/W** momentarily. Press the **REV** key to return to the frequency display when the scan-resume mode is set the way you want it.



You can stop the scanner manually by pressing the **PTT**, **UP** or **DWN** button on the microphone, or the **D/MR** button.

Memory Skip Scanning

When you have some very active channels stored in memories you may wish to skip them when scanning,

but still have them available for manual selection. You can mark a memory to be skipped by pressing **F/W** ⇒ **SKIP** (the **D/MR** button at the upper right) while receiving on the memory. A line of four tiny arrowheads (three for the sub channel) appears just to the right of the memory number box to show that this memory will be skipped during scanning (although you can still recall it manually).

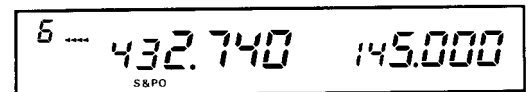

To re-enable a scan-skip memory for scanning, just repeat the steps you took to disable it: select the memory manually, and press **F/W** ⇒ **SKIP**.

Programmable Subband Limits

Besides band and memory scanning, the FT-5100 can be set to tune or scan only the frequencies between lower and upper limits of your choice. These limits are stored in the special 'subband limit memories' labelled **L** and **1L** (lower), and **U** and **1U** (upper):

- Store the lower edge of the desired scanning range in memory **L**, and the upper edge in memory **U** (or in memories **1L** and **1U**).
- With either of these memories recalled, press the **MHz** button momentarily.

As described previously in Memory Tuning, “MT” appears in the memory box, and you can tune the memory, but the frequencies stored in memories *L* and *U* (or *1L* and *1U*) now limit your tuning and scanning range to the resulting subband. If the either ARS or manual repeater shift is activated, repeater offset is applied automatically when you transmit (even if the resulting transmit frequency is outside the subband limits).

Note: The frequency resolution of subband limits is 100 kHz, although the channel resolution of the subband limit memories is the selected channel step size. Therefore the frequencies stored in these memories are *both rounded down* to the nearest 100 kHz for their purpose as subband limits. Since the subband limit memories are not limited to a specific frequency, you can still use them for other purposes within the 100-kHz range *above* the intended subband limit.

Example: To limit reception to 145.0 ~ 146.0 MHz

- Set the main display to the 2-m band, and tune the dial to any frequency between 145.000 and 145.095 MHz.
- Hold the **F/W** key for ½ second, tune the selector knob so that *L* appears in the 2-m memory box, and then press **F/W** again momentarily. The displayed frequency is now stored to provide an effective lower subband limit of 145.000 MHz.
- Tune the dial to any channel between 146.000 and 146.095 MHz.

- Repeat the second step, selecting *U* in the memory box. This stores the effective upper subband limit of 146.000 MHz.
- Press **D/MR** to change to memory operation.
- Press the **MHz** button momentarily to activate the 145.000 ~ 146.000 subband limits for tuning and scanning.

To cancel your subband limits and return to memory operation, press **D/MR** (if you are scanning, or want to return to dial operation, you must press it twice). Pressing the **CALL** button also cancels subband limits as operation switches to the CALL channel.

Once you have stored the *L* and *U* memories, you can reactivate the subband just by recalling either memory and pressing **MHz**. You can also press the **BAND** button to switch main and sub channels, without disturbing subband limits, even if scanning. However, you cannot activate the subband when the *L* or *U* memories are marked for skip-scanning, or if either of these memories are masked (hidden). The *1L/1U* memory pair behaves exactly the same way.

You will recollect from the memory bank description that each of the four banks in the FT-5100 has two pairs of subband limit memories: for a total of eight available subband limit pairs (four on each band). Of course you can set the main and sub channels to tune or scan different subbands, on the same or different bands.

Priority Channel Monitoring

The priority function allows automatic checking for activity on a memory every five seconds while operating on the dial or other memories. When the receiver detects a signal on the priority memory, operation automatically shifts to that memory while the signal is present (plus a few seconds). If you transmit while paused on the priority memory, priority monitoring ceases and operation stays on the priority memory.

To set up for priority monitoring:

- Preset the squelch, and store the frequency to be monitored in a memory (this must be memory 1 if you will be operating on other memories during priority monitoring).
- Press **D/MR** to operate in the dial mode, or else select the memory you want to operate on, and then press **F/W** ⇒ **PRI (MHz)**.

A “*P*” appears in the memory box, and about every five seconds the displayed frequency shifts to the priority memory briefly while the receiver checks for a signal.

While no signal appears on the priority memory to open the squelch, you can tune, transmit and receive on the dial, or select and operate on other memories (but not scan). If a station you wish to talk with appears on the priority memory, press the PTT switch momentarily while receiving their signal, to stop priority checking.

Otherwise, when a signal appears on the priority memory, priority checking will pause and the decimal on the display will blink. Priority monitoring then resumes according to how you set the scan-resume mode — either after a 5-second pause, or after the carrier drops. To cancel priority monitoring manually, press **D/MR**.

Note that you can use any other memory as a priority channel in the above procedure when you are going to be operating in dial mode. You cannot, however, switch from memory to dial operation or vice-versa without first cancelling priority monitoring (pressing **D/MR** cancels priority monitoring). You also cannot scan on the same band during priority monitoring, unless you do so on the other (sub or main) receive channel: in single-band dual-receive operation you can switch between main and sub channels and operate on the other channel in any way you wish without affecting priority monitoring on the first channel. You can even activate both receiver channels for priority monitoring simultaneously, effectively monitoring four frequencies at once (two on each receiver channel). During single-band dual-receive operation, if you switch bands while priority monitoring, the function will remain enabled, although it will be suspended until you return to that band. The priority function is also not disabled by switching the radio off.

CTCSS Operation

The built-in Tone Encoder function can be used to access repeaters and stations that require a CTCSS tone, by sending a tone whenever you transmit. Also, if you have the FTS-22 CTCSS Decoder Unit option installed, you can silently monitor for calls on busy channels (the FTS-22 includes separate decoders for each receiver channel). The encode function superimposes a subaudible tone (at a frequency too low to be heard) on the transmitted carrier. The optional (FTS-22) decode function monitors receiver audio through a narrow filter at the same subaudible frequency, keeping the squelch closed until you receive a signal with a matching subaudible tone. Installation of the FTS-22 is described at the back of this manual.

To check or set the CTCSS tone frequency, press **F/W** ⇒ **T.SET** (the same as the **TONE** key) to see the tone frequency displayed in Hz. To change the tone frequency, rotate the selector knob or press the microphone DWN/UP keys until the display shows the tone frequency you require (from the choices in the table below). Press **TONE** to return to the operating frequency display after checking or selecting the tone frequency.

To activate CTCSS operation just press **TONE** when the operating fre-

quency is displayed. **'ENC'** (encode) appears in reverse letters at the left edge of the display and the tone



generator is activated for transmission (on the main channel). If you press **TONE** again without the FTS-22 option, the encoder turns off. If the FTS-22 is installed, both **'ENC'** and **'DEC'** (decode) are displayed together as tone squelch is activated for both transmit and receive (requiring a matching tone to open the squelch). Pressing **TONE** a third time disables tone squelch.

You can store different CTCSS tones (and encode/decode states) in each memory in the same manner (and at the same, or different time) as storing operating frequencies. Later, to change the tone or state stored in a memory, just recall it, re-select the tone frequency or function, and store again.

The sub channel display shows a small **'D'** near the bottom right corner only if the CTCSS decoder is active on the sub channel (it shows nothing for the encoder, since the sub channel is not used for transmitting). The sub channel decoder can be toggled by the

CTCSS Tone Frequencies (Hz)			
67.0	97.4	136.5	192.8
71.9	100.0	141.3	203.5
74.4	103.5	146.2	210.7
77.0	107.2	151.4	218.1
79.7	110.9	156.7	225.7
82.5	114.8	162.2	233.6
85.4	118.8	167.9	241.8
88.5	123.0	173.8	250.3
91.5	127.3	179.9	
94.8	131.8	186.2	

TONE button when '**ALT**' is blinking (after pressing **F/W** ⇒ **SUB**). Of course settings are preserved when switching bands.

'CTCSS Bell' Paging with the FTS-22

CTCSS Bell operation is very similar to the CTCSS encode/decode operation just described, in that sub-audible tones open the squelch. However, if you are waiting for a call, it is sometimes convenient to have the transceiver 'ring' to get your attention. The CTCSS Bell mode displays a small bell at the left side of the display for the main channel, and at the lower right corner for the sub channel. When you receive a matching CTCSS call, the transceiver rings like a telephone, after which the small bell on the display blinks to indicate you received a call. To activate the CTCSS Bell:

- Set the desired band to the main display, if necessary, with the **BAND** button, and tune to the desired frequency.
- Select a CTCSS tone frequency using the **F/W** and **T.SET** keys as described on the previous page, if you have not already.
- When you expect to receive calls from stations using tone squelch (decoding, or CTCSS Bell), activate tone squelch encode/decode operation as described above, so you will not miss calls when you turn off the CTCSS Bell later to reply.

Press **F/W** ⇒ **BELL** (the **CALL** button, above the selector knob). A small bell icon appears to the left of the main frequency, or at to bottom right for the sub channel frequency), indicating that CTCSS Bell paging is now activated.

Now all calls on this channel without a matching CTCSS tone will be ignored by your receiver. Any call received with the matching CTCSS tone will cause the transceiver to ring and the squelch to open while the caller transmits. The bell icon begins to blink, and continues until you manually reset it (by pressing the PTT switch to transmit, retuning, or pressing **D/MR**). Note that the other station does not need to be using the CTCSS Bell function to call you: they can use normal CTCSS encode-only (or encode/decode) functions of their transceiver.

When you receive a call, disable the CTCSS Bell feature to prevent ringing every time the other station transmits: press **F/W** ⇒ **BELL** to turn it off.

The CTCSS Bell system is receiver channel-specific, but not memory-specific. You can activate it on the sub channel (after activating the CTCSS decoder), by pressing **F/W** ⇒ **OP** to display the blinking "**ALT**" indicator before selecting the CTCSS Bell mode. You cannot, however, store the CTCSS Bell mode selection in a memory (although you can store CTCSS tone frequencies and encode/decode states).

DTMF Paging & Code Squelch

The FT-5100 includes a DTMF tone encoder/decoder to provide paging (*pager mode*) and selective calling (*code squelch mode*) features under DTMF control.

Overview

The paging and code squelch systems use 3-digit numeric codes (000 ~ 999), transmitted as blocks of sequential DTMF (Dual-Tone, Multi-Frequency) tone pairs. The FT-5100 has twenty-eight *Code Memories* in which to store 3-digit DTMF codes. These are arranged in four banks, so that there are seven Code Memories for each of the main and sub receiver channels, on each band. Only two of these banks can be used at one time (one bank per receiver, during dual-receive operation).

When either DTMF paging or code squelch is active, the 100's-of-MHz digit of the operating frequency is replaced by a Code Memory number (0 ~ 6). In its most common function, the receiving station remains silent until it receives one of the stored 3-digit codes. Then the squelch opens so the caller is heard, and in the pager mode, the transceiver also rings like a telephone. When you press the PTT switch to reply, the same three prestored DTMF code digits are transmitted automatically. In the pager mode, three more DTMF digits (preceded by a DTMF asterisk) are also sent, representing your personal station identification.

The DTMF paging and code squelch systems are selected by the **PAGE** key to the right of the selector knob. Either “**PAG**” or a small “**C**” appears on the display when DTMF paging or code squelch is activated, respectively, and the 100's-of-MHz frequency digit is replaced by a Code Memory number (0 ~ 6). You can select which Code Memory is active using the microphone UP and DWN buttons (only!).

Next we will look at how these features operate in more detail, followed by the description of how to set up and use them.

DTMF Code Squelch

The code squelch mode is very simple. Both you and the other station communicate using the same 3-digit DTMF sequence, sent automatically by the FT-5100 at the start of every transmission. Your receiver normally remains silent to all signals that are not prefaced with your selected 3-digit code. When you receive the tones, your squelch opens and stays open until a few seconds after the end of each transmission.

In the code squelch mode, you must first store and then manually select the one Code Memory holding the 3-digit DTMF code required to open your squelch. This procedure is described on the following pages. Also, in the code squelch mode, Code Memories 1 ~ 6 all have the same function – distinctions and special settings that apply to the pager mode are irrelevant.

DTMF Paging

In the DTMF pager mode there are two different types of Code Memories. You can receive signals that are prefaced with any of up to six different 3-digit codes (per Code Memory bank), according to the type of Code Memories you have stored. When you receive a paging call, the selected Code Memory changes automatically, and the display responds in one of two ways, also depending on the type of stored paging code:

1. Individual Codes

These are personal ID codes to identify each station uniquely. You store one of these in each Code Memory bank for your ID, in Code Memory 1. In each Code Memory bank you can store up to five other Individual Codes of stations you call often, in Code Memories 2 ~ 6. When someone else transmits your Individual Code, your display shows "P" in the Code Memory position (that is, the 100's-of-MHz position), with the other station's Individual Code appearing to the right so you can see who called.

2. Group Codes

This type of code identifies a group of stations. You would generally share a Group Code with your friends or among club members. When you receive a call with a Group Code, the Code Memory number (2 ~ 6) in which you stored that 3-digit Group Code

Manual DTMF Calling

In either code squelch or pager modes, any DTMF-equipped station can call you (they can use a DTMF keypad to send the three digits if you are in code squelch mode, or six digits with an asterisk in the middle if you are in pager mode). Each tone (keypress) should be at least 0.2 seconds long, spaced less than 2 seconds apart.

appears in the Code Memory position on your display, with the 3-digit Code number to the right.

Note that for a Group Code, the display does not show the ID and code of the caller, but those of the group instead. Code Memories 2 ~ 6 can be used to store either Individual Codes (for calling purposes only) or Group Codes (for both calling and receiving), as you desire.

With either type of page, the **PAG** indicator starts blinking when a page is received, and continues until you reset it. This is convenient to let you know if someone called while your attention was elsewhere.

Remember, with code squelch operation (but not with paging), you can only receive a call on the currently selected Code Memory, and the display does not change when a call is received. So for code squelch, as mentioned above, the Individual/Group distinction

does not apply: although you must still store the 3-digit Code Memories, they all function the same way.

Storing Code Memories

The first thing to do before using the paging or code squelch systems is to store your Individual Code in Code Memory 1. Keep in mind that there are four separate banks of Code Memories. We will describe the process only for the main channel, and on one band. To set up the other band you can just switch bands, and to set up the sub channel you can press **F/W** ⇒ **OP** to activate the keys for the sub channel before starting the following procedure.

- Hold the **F/W** button for ½ second (until the memory box blinks and the second beep sounds), then press **PAGE** momentarily to enable the *Code Setting* mode. The frequency display is replaced by a blinking Code Memory number to the left of the decimal, and the corresponding 3-digit Code ('000' if not used before) to the right.
- Turn the selector knob, if necessary, to select Code Memory 1 (the Code Memory digit can be set to 0 ~ 6, with 0 being 'read-only', and 2 ~ 6 programmable with group or other individual's IDs). Code Memory 1 is for your personal DTMF paging ID Code.
- Press either the **MHz** button or the UP button on the microphone. The Code Memory number will stop blinking, and the next digit to the right will begin to blink. This is the first digit of the 3-digit DTMF Code.

- Now turn the selector knob to select a DTMF Code digit between 0 and 9, corresponding to the first digit of your personal ID code (in this Code Memory bank — each bank requires a separate entry).
- Press **MHz** or the microphone UP button again to cause the next digit to the right to blink, and again turn the selector knob to set the next digit of your ID code.
- Repeat the above step to set the last digit.

If you want to go back and change one of the three code digits, you can press the DWN button on the microphone to step backwards through the digits.

- Press the **PAGE** key to return the display to normal.

Your ID Code is now stored in Code Memory 1.

You use the same procedure to store the Memory Codes of other individuals or groups in Code Memories 2 ~ 6, but with an additional feature. Generally, you store another station's ID Code so you can page them, but you do not want to have your transceiver ringing every time someone else calls them. On the other hand, you store Group Codes with the intention of receiving any pages to the group (so you want your squelch to open and the transceiver to ring, if in pager mode).

During the Code Memory storage procedure above, when storing Code Memories 2 ~ 6, you have an opportunity to decide whether your transceiver should respond to incoming paging calls on a particular Memory Code. While in the Code Setting mode (after holding

F/W and pressing **PAGE**), you can press the **F/W** key to toggle DTMF squelch pager capability on and off. When on, that is, when the decoder is enabled to receive paging calls with this Code Memory, a small underbar appears beneath the Code Memory number at the left.

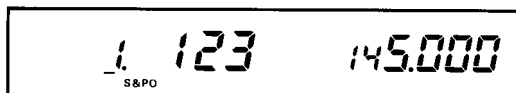

Therefore, if you are setting a Group Code (for receiving), you want to have the underbar on, and if setting another station's Individual Code (for calling purposes), you want it off. As already mentioned, this distinction does not apply to code squelch only (non-pager) operation: either setting works the same way.

Note that the underbar is displayed permanently on Code Memory 1, since this is your own ID (that you will always want to receive when pager mode is activated). Also, the underbar never appears on Code Memory 0, since this Memory slot is reserved for display of the ID of incoming paging calls.

Responding to a DTMF Page, and Resetting

Once your ID is stored in Code memory 1, you are ready to receive DTMF Paging calls directed to you. Any DTMF-equipped station can call you by sending your 3-digit code, followed by an asterisk, and their 3-digit ID Code. If you monitor with the code squelch activated ("**C**" displayed), your squelch will open when

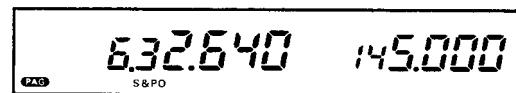

you receive your ID Code. If you are monitoring with the DTMF Paging feature activated ("**PAG**" displayed), the transceiver reacts according to how you stored your Code Memories, as described above. The paging ringing tones are distinctive for the two receiver channels, so you can distinguish on which frequency you are paged by ear, as well as by the display.

If you press your PTT switch after receiving a call, the Code (either Individual or Group) is transmitted, and if paging is enabled, your ID Code is sent.

When you receive a page your display shows "**P.**" and the caller's ID (Code Memory 0). Pressing your PTT switch causes your transceiver to transmit his ID, followed by your ID (Code Memory 1), and resets the pager to receive another call. The other station will then hear a ring from their receiver, as their squelch opens.

You should switch from paging to code squelch mode once contact is established, or your transceiver will continue to ring every time the other station transmits. To do this for the main channel, press **PAGE** once, so that a small "**C**" appears to the left center of the frequency. For the sub channel, press **F/W** ⇒ **OP**, if needed to get the "**ALT**" indicator blinking, then **PAGE** once, so a small "**C**" appears in the upper right corner.

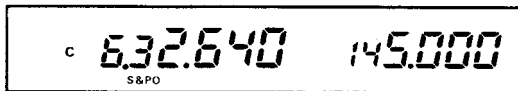

With Code Squelch activated in this manner, you will hear three (muted) DTMF code digits transmitted when you press your PTT switch. These digits are those stored in the Code Memory currently displayed (in place of the 100's-of-MHz digit), and they will open the squelch of the other station. Since his initial paging call automatically set his ID into (your) Code Memory 0, you will be sending his ID. Therefore, at the start of each transmission, you must wait a second or two after pressing the PTT switch for the DTMF code to be sent (you will hear it in your speaker).

DTMF Code Delay

When calling other stations using paging or code squelch, you may find some are unable to receive your calls. This can be caused by their squelch not opening fast enough (after receiving your carrier) to allow all of the DTMF digits to be received. To correct this, you can set a longer delay between key-down and the start of the DTMF code.

With any Code Memory displayed, press the **RPT** key. An **L** will appear in the memory box when the longer delay is activated. This setting affects all paging and code squelch transmissions.

Important! If you originated the page, you must also press the UP button on your microphone to switch the current Code Memory to your ID (Code Memory 1). If you don't, or if both stations take the same actions after a paging connection, you'll each end up using a different DTMF Code, and fail to open each other's code squelch.

To reactivate Code Paging when your conversation is finished, press **PAGE** twice so "PAG" is displayed.

Display Brightness

As supplied from the factory, the brightness of the display backlighting is controlled automatically by a photosensor. You can disable the automatic control and set the brightness manually, if desired:

With the transceiver switched off, press and hold the **MHz** button near the upper left while switching the transceiver on.

Release the **MHz** button and press the **F/W** button. Then within five seconds, turn the selector knob to set the desired display brightness.

Wait five seconds, or press **F/W** again, to return the control functions to normal operation.

To reactivate automatic brightness control, repeat the first step above.

In Case of Problems

You should not despair if you find some aspects of FT-5100 operation somewhat complicated at first. The small number of controls belies the variety of features that are available, and some keys and buttons have more functions than are indicated by their labels. So it is not difficult to get lost, at least until you have had the chance to learn the various functions of the display and keys. This section provides some tips to help you navigate the various display and key modes.

If the display shows nothing at all, push and hold the power switch for 1/2 second, and check the power supply connections.

The state of the display tells a lot (but not all) about the current state of operation. Each half of the display can take on as many as five different states. These are shown at the right for the main channel, together with the key to press in each case to return to the operating frequency display.

It is well worthwhile to study the main frequency display diagram on page 5 carefully. This display is the basis for basic operation. For example, if the frequency display changes unexpectedly when you transmit (or if "Err" appears), check for a small '+' or '-' near the lower left, and press the **RPT** button if present.

If pressing a button appears to do nothing, first check for "LOCK" at the center of the display. If you see

Main Frequency Display



Tuning Step & Scan Mode Display (press REV)

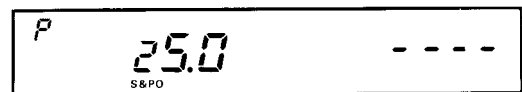

Repeater Shift/ARS Display (press RPT)



CTCSS Tone/Beeper Display (press TONE)



DTMF Code Memory Display (press PAGE)

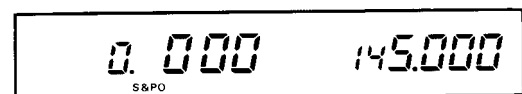

it, press the **F/W** ⇒ **LOCK** (the **LOW** button, just above the microphone jack) to unlock the keys. Also check the display for a blinking “**ALT**” above the **VOL** control, indicating that key operations are being applied to the sub channel (at the right), rather than the main channel. Press **SUB** to return control to the main channel. Otherwise, you can press the **D/MR** button, which will usually terminate any partially entered commands.

If the 100’s-of-MHz digit is weird (0, 2, 3, 5 or 6) or behaves strangely when you try to tune, check for either “**PAG**” or “**C**” displayed at either the left side of the main display, or the right of the sub display, indicating that DTMF paging or code squelch is active. If so, press **PAGE**, twice if necessary, to clear these symbols and return the frequency display to normal.

If the radio still doesn’t obey your commands, check to see if the “**TX**” indicator near the upper left of the display is on, indicating that it is transmitting. Releasing the PTT switch should return the set to receive. If still nothing happens, switch the transceiver off, and then back on.

If the display is completely blank, or if it shows all segments at the same time, and you cannot turn the transceiver off, you may have inadvertently started memory cloning - see the *Caution* box on the next page.

Finally, if you are unable to gain sensible control of the transceiver, reset the CPU as described below.

To avoid confusion resulting from inadvertent button presses, set the keypad lock on (press **F/W** ⇒ **LOCK**) if you leave the transceiver unattended while it is on. Remember to set the lock back off when you wish to enter data.

Resetting the CPU

Resetting the CPU clears all memories, repeater shifts and other settings to their defaults, and leaves the transceiver CPU in the same state as when it left the factory. To reset the CPU, press and hold the **D/MR** button and **REV** key while turning the transceiver on.

Memory Backup

Normally, a lithium battery inside the transceiver retains all settings and memories while power is off or disconnected. If this battery ever needs replacing, the transceiver will be found to have lost its memories, although it will still operate properly.

The backup battery is on the inside of the front panel, and is not easy to access. We therefore recommend that it be replaced only by a Yaesu-authorized technician to ensure that it is installed properly.

Memory Cloning

All memory data stored in one transceiver can be moved to another by connecting the microphone jacks together as indicated in the diagram below.

- Turn both transceivers off, and then press and hold the **F/W** keys while turning the power switches on. All segments of the displays will be blinking.
- Press the **REV** key on the destination transceiver (the display will stop blinking, and either go blank, or show all segments).
- Press the **RPT** key on the source transceiver. When the data transfer is complete, the displays should return to normal. If “**Err**” appears on the display, turn both transceivers off and try again. If the display of

Caution!

Do not attempt memory cloning without having a proper cable connected between the microphone jacks. If you do not have a cable, or if the connections are incorrect, the transceiver microprocessors may freeze up, preventing the set from being turned off. In this case, you will need to disconnect the power cable to restart the microprocessors.

the destination transceiver remains all blank or all on, and you cannot turn the transceiver off, see the Caution box, and recheck your cable.

- Turn both radios off and remove the cloning cable.

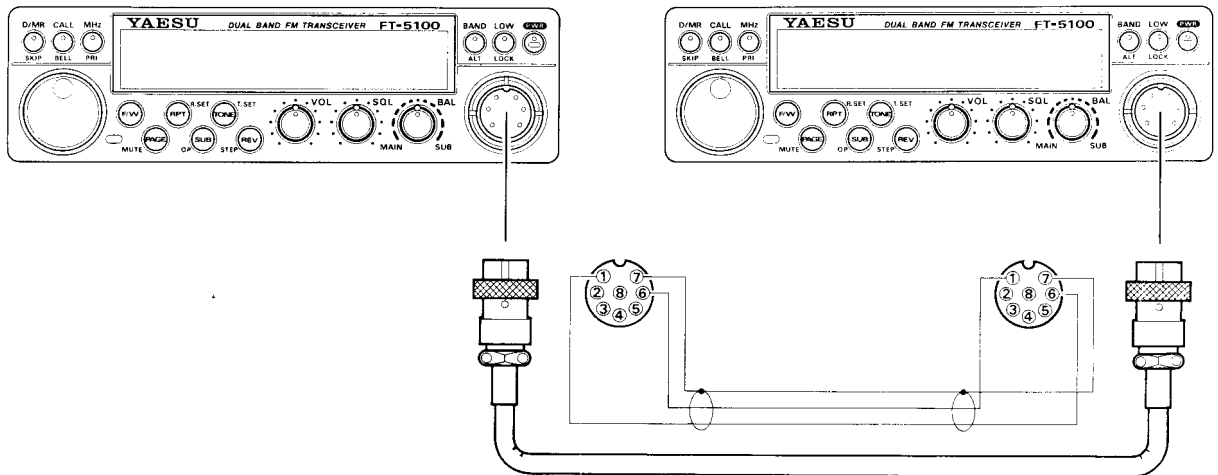

Packet Radio TNC Interconnections

Many popular packet radio TNC units can be connected to the **DATA IN/OUT** jack on the rear panel. Use shielded cable for the audio lines, keep them as short as possible to avoid RF pickup. There is no connection for squelch status, so your TNC should have a PLL-type DCD circuit.

Important Note: Both main and sub receiver audio are present at the DATA IN/OUT jack on the rear panel during dual-band operation. This fixed-level audio is independent of speaker audio and is not affected by **VOL** and **BAL** controls. To avoid possible interference during packet signal reception from unwanted sub receiver audio mixing, single band operation is recommended. Select the desired band using the **BAND** and

SUB keys as described in the *Operation* section of this manual.

For packet operation, the transmitter is keyed by pulling down the impedance of the tip contact of the **DATA IN/OUT** jack. This must be done by the PTT control line of the TNC, by connecting this line through a 2 to 3.3-k Ω resistor to the tip contact (along with transmit audio). See the schematic diagram below.

After making the connections, you may need to adjust the TNC's input and output level controls for proper modulation and demodulation. The FT-5100 provides a constant level of receiver output (200 mVp-p), and requires input of 20 mV for transmission. Refer to your TNC manual for details of the procedure.

The time-out-timer Adjusting

The time-out-timer is factory preset to 15 minutes. To change this default setting, press and hold the **LOW** key, while turning on the transceiver.

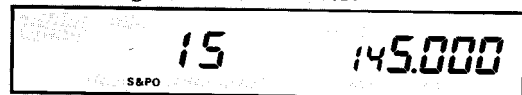

Then, using the selector knob or microphone buttons, select your desired time-out-time. (Adjustable from 0 ~ 60 minutes in 1 minute steps)

Press the **LOW** key to return to normal operation.

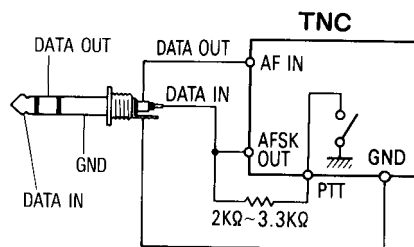

FTS-22 Tone Squelch Unit Installation

The FTS-22 includes an encoder and decoder for 38 EIA standard subaudible CTCSS tones, programmable from the front panel of the FT-5100. It provides silent monitoring of busy channels when activated by the ENCode/DECode Tone Squelch function. Tone squelch operation on both channels or bands requires only one FTS-22. See the *Operation* chapter for details.

- Disconnect the power cable, and turn the set upside-down. Referring to Figure 1, remove the six screws affixing the bottom cover, and remove the cover.
- Referring to Figure 2, locate unused 12-pin connector J5005 inside the front panel.
- Peel the covering from one side of the double-sided tape provided with the FTS-22 and stick it on the top of the VCO housing just behind J5005.
- Note in Figure 3 how the FTS-22 cable routes over the top of the board. Plug the FTS-22 cable into J5005.

Then peel the covering from the exposed side of the tape, and press the FTS-22 onto it.

- The factory adjusts the output tone level (VRI on the FTS-22) for the proper deviation, so it should require no further adjustment.
- Replace the bottom cover removed in the first step.

Figure 1.

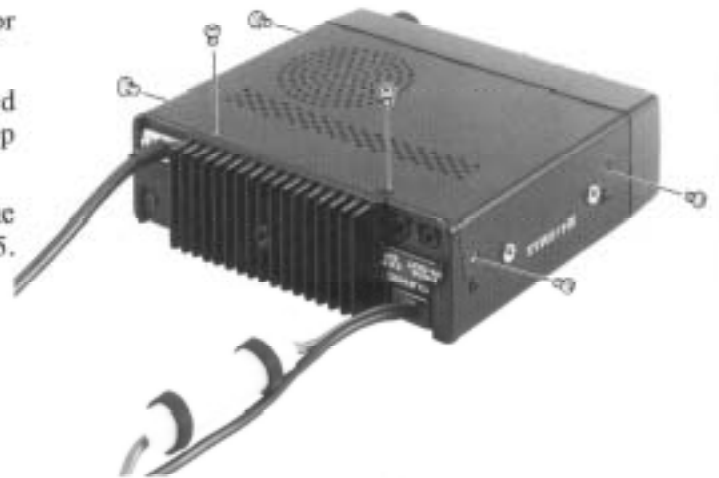

Figure 2.

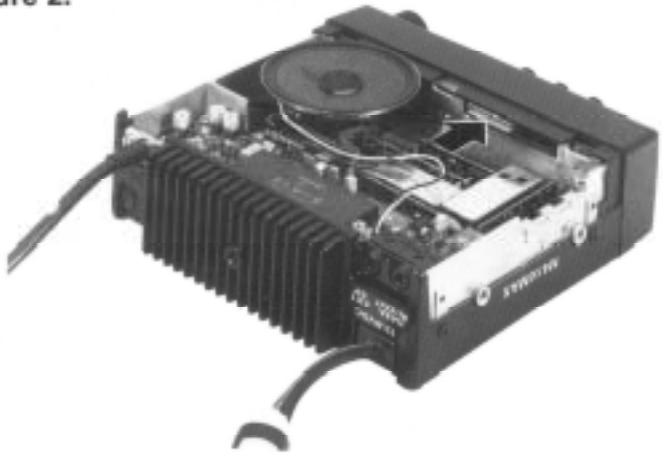
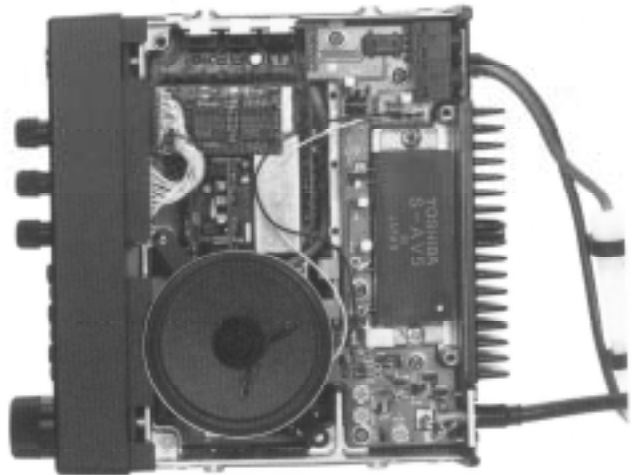

Figure 3.



Copyright © 1992
Yaesu Musen Co., Ltd.
All rights reserved.
E04001003(408X-OS)

YAESU MUSEN CO., LTD.
C.P.O. Box 1500, Tokyo, Japan

YAESU U.S.A.
17210 Edwards Rd., Cerritos, California 90703
U.S.A.

YAESU EUROPE B.V.
Snipweg 3. 1118DN Schiphol, The Netherlands

YAESU UK LTD.
Unit 2, Maple Grove Business Centre
Lawrence Rd., Hounslow, Middlesex TW4 6DR, UK