

TEN-TEC

**OPERATOR'S
MANUAL**

**ARAGONAUT
MODEL 509**



CONTENTS

<u>SECTION</u>	<u>TITLE</u>	<u>PAGE</u>
I	INTRODUCTION	1-1
	CONDENSED OPERATING INSTRUCTIONS	1-1
	SPECIFICATIONS	1-3
II	DETAILED OPERATING INSTRUCTIONS	2-1
	Rear Panel Connections	2-2
	Front Panel Controls	2-3
	GENERAL OPERATING NOTES	2-5
III	ALIGNMENT AND SERVICE	3-1
	MAIN CHASSIS	
	Pilot Light Replacement	3-1
	Dial Cord Replacement	3-1
	Dial Calibration	3-2
	Disassembly	3-3
	BLOCK DIAGRAM	3-4
	FIGURE 1 - TOP VIEW	3-5
	FIGURE 2 - BOTTOM VIEW	3-6
	FRONT END 80262	3-7
	OSCILLATOR 80233	3-10
	TX-RX MIXER 80261	3-13
	I.F. BOARD 80208	3-15
	AUDIO POWER AMPLIFIER 80274	3-17
	SSB GENERATOR 80131	3-19
	RF POWER AMPLIFIER 80185	3-22
	LOW PASS FILTER - SWR BRIDGE 80260	3-24
	CONTROL BOARD 80126	3-25
	WARRANTY AND SERVICE POLICY	Insert

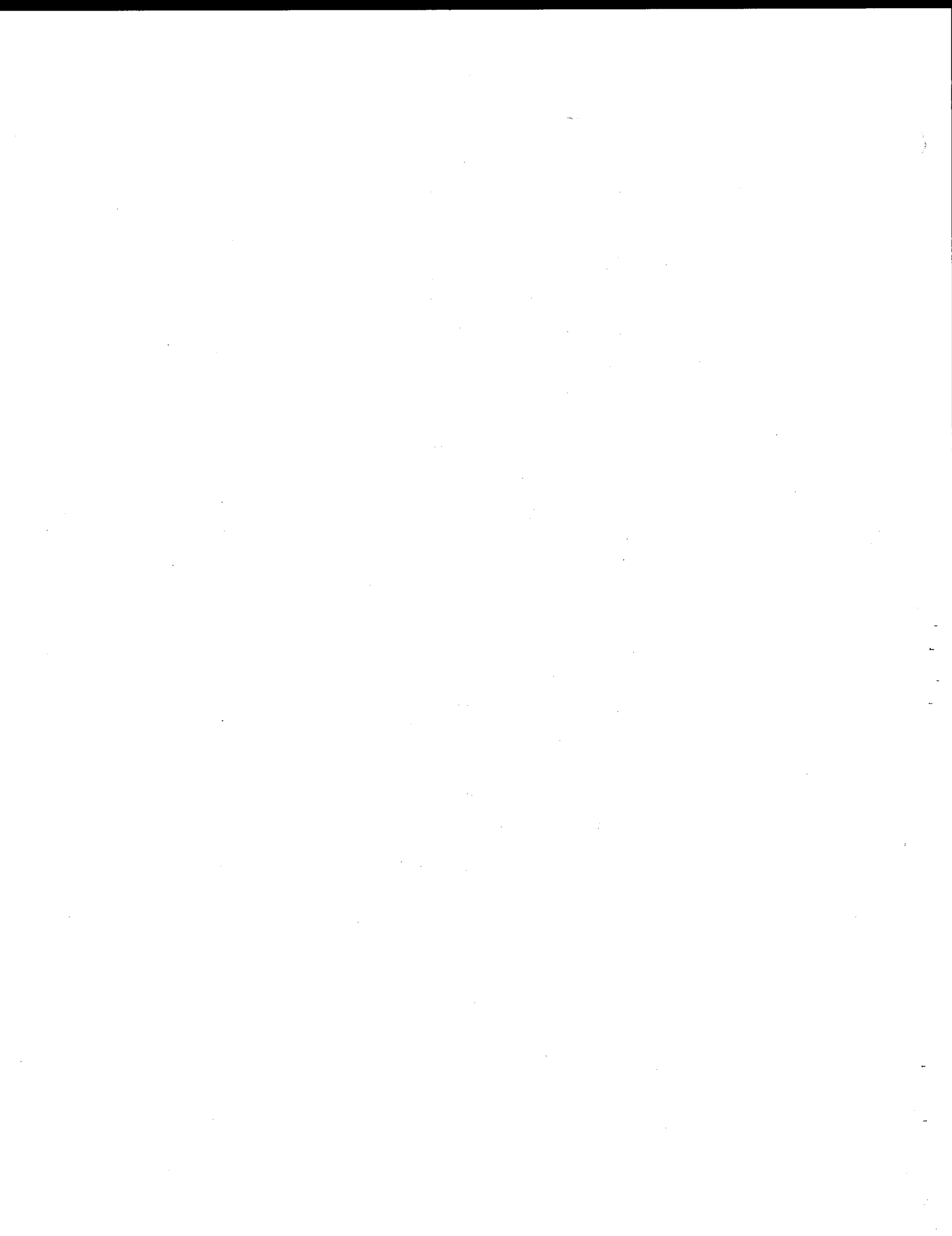

SECTION I
INTRODUCTION

The Argonaut opens a whole new world of excitement and fun in Amateur Radio. We think you will find QRP a welcome change. Five watts are only 2½ S-units below 150 watts for the same conditions. When skip is favorable and QRM light, you will not be conscious of using low power.

The small size (1/5 cubic foot) makes it ideal for portable operation in a motel, camper, trailer, or mobile operation in your car, boat or plane. As a result of its low power requirement, a 12 volt lantern or automobile battery will provide many, many operating hours. An ac pack, available as an accessory, will provide 117 VAC operation. You can choose ssb or cw on any ham band between 3.5 and 30 MHz.

On the following pages you will find a set of condensed operating instructions. These are sufficient to place the Argonaut in operation. We do, however, highly recommend a thorough reading of the detailed instructions and the theory of operation. Only by a complete understanding of all controls can the Argonaut be used to its maximum capabilities.

CONDENSED OPERATION INSTRUCTIONS

The following instructions will enable the operator to quickly place the Argonaut in operation. For a more comprehensive description of the controls and their functions, read the detailed operating instructions.

REAR APRON CONNECTIONS AND CONTROLS

+12 VOLTS IN JACK - Use a 12 to 14 volt, dc power source capable of delivering one ampere, negative ground.

ANTENNA JACK - Connect a 50 to 75 ohm, unbalanced resonant antenna such as a beam, dipole or vertical. Balanced antennas and those with higher impedances should be matched to the Argonaut with an antenna tuner, such as the TEN-TEC Model AC5-205.

MIC JACK - If ssb operation is intended, use a high impedance dynamic, crystal or ceramic microphone. Use a standard 1/4" stereo plug -- tip to Push-To-Talk switch, band to microphone, and sleeve to common ground.

KEY JACK - If cw operation is intended, connect a straight key, bug or electronic keyer.

RECEIVE/TRANSCIVE - Set switch to TRANSCIVE position.

ACCESSORIES - Dummy plug with jumper between pins 4 and 5 must be inserted into socket.

FRONT PANEL CONTROLS

A.) Tune-Up

- 1.) Select desired band with BAND switch.
- 2.) Tune dial to approximate frequency desired.
- 3.) Set METER switch to FWD position.
- 4.) Turn unit on by pushing POWER ON-OFF knob in.
- 5.) Advance MODE switch to LOCK position.

- 6.) Rotate DRIVE control clockwise for full scale meter reading.
- 7.) Check antenna match by rotating METER switch to REV position and noting SWR reading. SWR should be below 3:1 for best operation. If it is not, use antenna tuner or adjust antenna system for better match.

B.) Operation - CW

- 1.) Reset MODE switch to CW position.
- 2.) To transmit, merely key the Argonaut for complete break-in operation.
- 3.) To receive, adjust af and rf controls for desired audio level, and peak received signal with RESONATE control.
- 4.) For OFFSET tuning procedure, refer to the detailed operating instructions.

C.) Operation - SSB

- 1.) Reset MODE switch to SB-N position.
- 2.) Set DRIVE control so that with the push-to-talk switch closed, voice peaks cause the meter to deflect to about 1/3 of full scale.
- 3.) To receive, adjust af and rf controls for desired audio level after peaking signal with RESONATE control.

SPECIFICATIONS

1-3

RECEIVER

SENSITIVITY - Less than 0.5uv for 10 db signal-plus-noise-to-noise ratio.
SELECTIVITY - 2.4 kHz at 6 db down. 1.7:1 shape factor at 6/50 db.
INPUT - Low impedance unbalanced coaxial input.
OUTPUT IMPEDANCE - 8 ohm speaker or headphones. (High or low impedance headphones can be used.)
POWER OUTPUT - 1 Watt at 8 ohms with less than 2% distortion.
SPURIOUS RESPONSE - More than 50 db down.
AUTOMATIC GAIN CONTROL - (Max) For 100 db change in input signal level, output changes less than 6 db.
OFFSET TUNING - With pull-out defeat switch.

TRANSMITTER

DC POWER INPUT - 5 Watts PEP; 5 watts CW.
RF POWER OUTPUT - 2 Watts (50 ohm non-reactive load), minimum.
OUTPUT IMPEDANCE - 50 to 75 ohms.
TRANSMIT-RECEIVE OPERATION - SSB: PTT. CW: Complete break-in.
CW SIDETONE - Internally switched. Operates only in CW mode.
MICROPHONE INPUT - High impedance. Crystal, ceramic or dynamic.
CARRIER SUPPRESSION - 40 db from single tone output.
SIDEBAND SUPPRESSION - 30 db Down from a single tone output at 1000 Hz reference.

GENERAL

FREQUENCY COVERAGE - 3.5 to 4.0, 7.0 to 7.5, 14.0 to 14.5, 21.0 to 21.5, 28.0 to 30.0 MHz.
FREQUENCY STABILITY - Less than 100 Hz, change from 10.5 to 14VDC.
MODES OF OPERATION - Normal sideband, Reverse sideband, CW.
DIAL CALIBRATION - \pm 5 kHz on 80 through 15 meters, \pm 10 kHz on 10 meters.
TUNING RATE - Approximately 25 kHz per knob revolution, 80 meters through 15 meters. 100 kHz on 10 meters.
FRONT PANEL CONTROLS - Resonate. Offset (pull-off). Band Selector. Tuning Knob. RF Gain. AF Gain/Power On-Off. Mode Switch. Meter Switch. Drive.
REAR APRON CONNECTORS - Antenna. Dial light switch. Microphone jack. Headphone/speaker jack. Receiver antenna. Auxilliary 12 V output jack. Key jack. Power in jack. Receive/Transmit antenna switch. Accessories socket.
SEMICONDUCTOR DEVICES - 32 Transistors, 3 Mosfets, 3 I.C. and 18 Diodes.

POWER REQUIREMENTS - 12-14 VDC regulated to 10% with 1 ampere load.

CABINET DIMENSIONS - HWD 4½" x 13" x 7½".

MATERIAL - Case, aluminum. Side panels, Cycolac.

NET WEIGHT - 6 pounds.

SHIPPING WEIGHT - 8 pounds.

DETAILED OPERATING INSTRUCTIONS

GENERAL

The Argonaut is the first miniaturized transceiver incorporating a full array of operating features. It operates on SSB/CW over the five popular Amateur H.F. bands including all segments of the 10 meter band. The input to the final stage is nominally five watts.

QRPP

This is the designation given to communication with output power of 5 watts or less. There are thousands of Amateurs who have found QRPP to be an enjoyable hobby. Clubs have been formed and contests are frequently conducted.

Five watts and less can work anywhere in the world under favorable propagation and interference conditions. The following general observations might be helpful:

- 1.) Select the highest frequency band that is completely open.
- 2.) Call loud stations. We assume two-way skip which would also enhance your signal. Remember that 5 watts is 2.5 S-units below 150 watts so if you call an S-9 signal yours will be S-6/7 if antennas are equal.
- 3.) Choose a part of the spectrum that is not heavily populated. A QRPP signal, especially a clean readable Argonaut signal, sometimes gets through QRM but in general, it is better to stay out of QRM.
- 4.) Don't call CQ except during favorable band conditions. There is a tendency for others to call strong signals.
- 5.) Call and sign a little longer than when running high power. On CW send a little more slowly. With phone, annunciate clearly.

QRPP is not push-button communication. Because it does take skill and technique it is an exciting and challenging facet of Amateur Radio.

MOBILE OPERATION

The Argonaut is ideally adapted to mobile operation in a car, boat, plane or any other vehicle. It operates from a 12 volt battery source (cigar lighter outlet) and is self-contained except for key, microphone and antenna.

When used with an alternator charged battery, start the vehicle's engine before turning Argonaut on. This avoids applying a voltage surge caused by momentarily open voltage regulator contacts.

Normally, there will be negligible noise introduced through the DC power leads. If it should occur, it can be eliminated by inserting the low voltage winding of a filament transformer in the power lead.

FIXED STATION

The Argonaut with conventional antennas will perform with distinction in any ham shack. With a linear, the power can be increased to anything desired-- up to the legal limit.

For an emergency or stand-by station it will operate for long periods with a 12 volt lantern or storage battery.

For use with a conventionally powered station, the receiver can be used as a separate unit, thereby splitting a transceiver for DX work. It is also a reserve stand-by receiver. WWV reports are available to those who do not have this feature on their set.

PORTABLE

The diminutive size and light weight of the Argonaut makes it an ideal traveling companion.

A 12 volt lantern battery (or two six volt batteries in series) will last many hours. To conserve battery power, be sure to switch off the dial light when not needed. Using headphones or reducing audio volume will conserve power. SSB will require less power than CW. The battery will give optimum results down to 10.5 volts.

Antennas are a matter of choice and convenience. A mobile whip antenna may be used with a suitable ground system (radials) or excellent earth ground. Matched, resonant dipoles are fine if there is a support for them. A random length "long wire" is also effective but must be matched with an antenna tuner (TEN-TEC AC5 or equivalent). In any event, the SWR should be 3:1 or better.

REAR PANEL CONNECTIONS

POWER SUPPLY

The Argonaut requires a supply of 12-14 volts capable of approximately one ampere peaks. The unit will operate satisfactorily, at reduced power and sensitivity down to +10½ volts. It may be operated with any mobile installation having a 12 volt negative ground electrical system. When operating mobile it may be necessary to install a small choke in series with the +12 volt lead to eliminate alternator whine or generator noise. The secondary of a low voltage filament transformer or choke of similar current rating will work satisfactorily. For portable operation, the Argonaut may be powered by a 12 volt lantern battery or small storage battery.

ANTENNA

Any matched antenna presenting 50-75 ohms will work satisfactorily. Random length antenna or open wire fed systems will require a matching system similar to the TEN-TEC Model AC5. Any of the popular mobile antennas will operate without any special matching. If it is not mounted on a car, a good ground system or counterpoise should be provided. The Argonaut output is designed for an unbalanced feed system. The coax shield is connected to the shell of a phono plug and the center conductor is connected to the pin of the phono plug.

If a separate receiving antenna is to be used, or if a full break-in linear amplifier is to be used in conjunction with the Argonaut, connect the receiving antenna, or lead from the linear T/R antenna relay, to the jack marked REC. ANT. and set the RECEIVE/TRANSCIVE switch in the RECEIVE position.

MICROPHONE

The input has been designed for a high impedance ceramic, crystal or dynamic microphone. The cable should be terminated in a ¼" diameter stereo phone plug. The shield and/or ground lead is connected to the barrel. The push-to-talk switch is connected to the tip and the microphone to the band.

The push-to-talk switch operates with respect to ground. The microphone gain control in SSB is the DRIVE control. The DRIVE should be advanced, under normal operation, until the FWD meter reading reaches approximately 1/3 scale on voice peaks. The transmitter gain varies from band to band. This may require changing the DRIVE setting for proper operation.

KEY

The key actuates a series of circuits on the control board that supply voltage to the various transmit and receive stages. When the key is closed, bias is

removed from the receive stages and applied to the transmit stages. The antenna is changed from receive to transmit with a reed relay. There is a small time constant in the audio muting circuit to eliminate any clicks while keying. It is not long enough to interfere with the complete break-in operation of the Argonaut. The CW sidetone operates only when the mode switch is in the CW position.

The sidetone volume is independent of the front panel volume control. Volume may be set to the desired level with the printed circuit thumb potentiometer located on the audio power amplifier board. A finger access hole is provided in the bottom plate.

AUDIO

A jack is provided for an external speaker or headphones. When in use, the jack will automatically disconnect the internal speaker. The amplifier output was designed for an 8 ohm load, but will perform satisfactorily with high impedance phones or speakers with 4 to 16 ohms impedances.

ACCESSORIES

This socket gives access to the +12 volts, the audio line and the "t" voltage which is present only in the transmit mode. To maintain continuity of the audio channel, the dummy plug with jumper between pins 4 and 5 must be inserted. If Model 208 CW Filter is used, remove the dummy plug and insert cable from 208 into this socket.

PANEL LIGHTS

A slide switch is located on the rear of the unit to turn the panel lights on and off. This allows a minimum drain when the unit is operated from a battery supply.

FRONT PANEL CONTROLS

RF/AF CONTROLS

The RF gain controls the bias to the receiver rf amplifier. This is used primarily to reduce the susceptibility to overload in the presence of extremely strong signals. The AGC will be dependent on the rf gain setting. The AF control controls the input to the power amplifier stage.

To minimize AGC popping, with RF fully clockwise, adjust the AF control setting while receiving a strong station to a level just a bit louder than desired. Then, control the level of this and all other stations to the desired level with the RF control.

MODE SWITCH

SB-N is the sideband normally in use on all bands. It will provide upper sideband on 20, 15 and 10 meters and lower sideband on 40 and 80 meters. The proper sideband is automatically selected by using either the sum or difference frequency in the mixer. The opposite or reverse sideband can be selected on the MODE switch, (SB-R), when needed.

The CW position connects the sidetone and disables the balanced modulator. The receiver is operated on the normal sideband. The transmitted signal is automatically offset 750 Hz from the received signal. This compensates for the BFO beat note and allows the transmitter to be on the frequency of the received signal.

The LOCK position is used for tune-up or antenna measurement purposes. It places the transmitter on the CW frequency and energizes the T/R circuits and antenna relay.

DRIVE CONTROL

This control determines the gain of the balanced modulator and is used to set the proper drive to the final amplifier. Overdrive on any band will not cause damage to the Argonaut. It will, however, result in an increased current drain for a given output. Excessive current, in turn, may result in chirpy CW signals and distorted SSB.

METER SWITCH

The meter may be used as an "S"-Meter or with the built-in SWR bridge. It has provision for reading both forward and reflected power. The switch is placed in the forward position and the transmitter is turned on. Set the meter to full scale with the DRIVE control. Switch to REV to read the standing wave ratio (SWR).

BANDSWITCH AND MAIN TUNING

The bandswitch selects the Amateur bands of 3.5, 7.0, 14.0, 21.0 and 28.0 MHz. It switches both the main VFO frequency and the transmitter/receiver tuned circuits.

The main tuning knob carries a dial skirt marked in 1 kHz increments up to 100 kHz. This scale is used in determining the frequency of operation within the 100 kHz segment noted on the slide rule dial pointer for all bands except the 28 - 30 MHz band. In this case, each marking represents 4 kHz and one complete rotation represents 400 kHz. On this band, the upper slide rule scale is used.

Since the VFO tuning shaft is raised from chassis potential to eliminate frequency jumping caused by poor sliding contacts, there is a small hand capacity effect on frequency when either the dial skirt or knob insert is touched. This effect is most pronounced on the 7.0 and 28 MHz bands due to oscillator tripling on these bands. To reduce the effect to negligible proportions, grasp only the plastic portion of the main tuning knob when fine tuning the VFO.

RESONATE CONTROL

The RESONATE control operates a mechanical assembly that permeability tunes the receiver rf amplifier circuits. This is all the tuning required when changing bands. The transmitter section does not require any adjustments.

OFFSET TUNING

The OFFSET control tunes the receiver independently of the transmitter. A push-pull switch is attached and the offset is disabled by pulling the knob out. It is more convenient to leave the offset control in operation and set to zero. It is then instantly available when needed. The circuitry is stable and should not change frequency. The zero is checked by turning the offset on and off and no change in the frequency of the received signal should be noticed.

Due to a residual small voltage being present across the OFFSET control when OFFSET is disabled, a very slight frequency shift may be noticed when rotating the control between its extremes. This is a normal condition and of no consequence due to the small magnitude of the variation.

CALIBRATION AND WWV RECEPTION

The broadcasts of WWV and WWVH may be received on 15 MHz by the following tuning procedure.

- 1.) Set the band switch to 21.0 MHz.
- 2.) Turn the slide rule dial and the frequency readout dial to zero.
- 3.) Tune the RESONATE control to an area between 3.5 and 7.0 MHz. By tuning RESONATE and the frequency readout dial, WWV will be heard if the band is open.
- 4.) Tune the frequency readout dial until the receiver zero beats with WWV.
- 5.) Set the aluminum dial to zero. It may be necessary to hold the black tuning knob when turning the readout dial.
- 6.) This calibrates the 21 MHz band only.

To calibrate all bands, Model 206 Crystal Calibrator can be inserted into the antenna line. This calibrator provides check points every 100 kHz, and the signal is pulsed for easy identification.

GENERAL OPERATING NOTES

- 1.) When the METER switch is set to the S MTR position, incoming signal strength can be determined, provided the rf gain control is advanced to maximum.
- 2.) The S-Meter will deflect to full scale in the transmit mode. This is normal.
- 3.) The RESONATE control should be re-peaked whenever the operating frequency is changed by approximately 50 kHz or more on the low frequency bands.
- 4.) When changing bands, or going to the opposite ends of the 80 meter band, the DRIVE control should be reset so as to maintain maximum output without overdrive.
- 5.) Although improper antenna will not damage the Argonaut, we suggest careful tune-up for maximum performance.
- 6.) In CW transmit mode, the carrier is automatically offset by 750 Hz. In so doing, the transmitted frequency is exactly the same as the received signal, (assuming OFFSET control is in center position or defeated), when the received signal is tuned to provide a 750 Hz beat note.
- 7.) In SB-R mode, the dial calibration will be off by approximately 2.5 kHz due to carrier oscillator shift. If accurate calibration is desired in this mode, it is suggested that a crystal calibrator be used and the dial skirt re-zeroed.
- 8.) In mobile operation, start the engine before turning transceiver on.
- 9.) The VFO in the Argonaut, like any LC oscillator, is adversely affected by stray ac magnetic fields cutting the coil winding. The oscillator output becomes frequency modulated at the line frequency, or some multiple of it, causing a "dirty" CW note and/or poor quality audio in both receive and transmit modes. When installing the transceiver, locate any ac operated equipment that may generate these fields as far as practical from the Argonaut. Power supplies, electric clocks, keyers, rotator control boxes are common sources of trouble.

Since the VFO is located front and center, the most common cause of FMing is the placing of such accessories on top of the Argonaut. A check of the purity of a received CW signal should be made at the time of installation.

SECTION III

ALIGNMENT AND SERVICE

This section is subdivided into descriptions of the main chassis and each plug-in assembly. Pin and transistor terminal voltages are given for each unit. Readings should be within 15% of listed values when measured with a dc voltmeter with at least a 20,000 ohms per volt impedance. All readings are dc and positive with respect to chassis GND unless noted otherwise. The plug-in pin locations are in the same relative positions on the assemblies as they are noted on the schematics. In other words, if, after first determining the correct orientation of the assembly with regards to which set of pins are which, the assembly is placed component side up on the schematic in this position, the individual pin functions are the same as those noted on the schematic.

When removing a plug-in assembly, note the orientation of the board in the chassis so that it can be replaced in the same orientation. The assemblies can be inadvertently inserted incorrectly if care is not taken. To remove a plug-in, first remove the two or more screws holding the board to the sockets. Then, with long nose pliers, work the assembly straight up by pulling on the four corner pins in sequence. On single connector boards, remove the nut or screw holding the board to the chassis as well as those holding it to the socket and remove by pulling up on the two end terminals in sequence.

To facilitate location of the various alignment and adjustment components, the table below lists the particular assembly where each function is found.

Function	Assembly
Receiver rf Amplifier	Main Chassis - 80262 Front End
Receiver 9 MHz Trap	Main Chassis - 80262 Front End
Receiver Mixer	TX-RX Mixer 80261
Receiver i.f. Amp.	I.F. Board 80208
S-Meter Zero Adj.	Control Board 80126
Sidetone Level	Audio Power Amp 80237
Carrier Balance	SSB Generator 80131
USB and LSB Carrier Adj.	SSB Generator 80131
CW Trans. Offset	SSB Generator 80131
Transmitter Mixer Null	TX-RX Mixer 80261
Offset Zero Adjust	Control Board 80126
Reverse SWR Set	Low Pass Filter - SWR Bridge 80262

Note: All VFO linearity, band edge calibration and multiplier adjustments are contained in the VFO sub-chassis on the main chassis. This section is described as a separate assembly for simplicity.

PILOT LIGHT REPLACEMENT

There are three pilot lights in the Argonaut. One is located behind the meter and two between the front panel and sub-panel. The meter light is a number 1892 bayonet bulb. To replace, remove the top. The remaining dial lights require removal of the front panel. Refer to alignment section for instructions on front panel removal. These bulbs are miniature 6 volt 50 ma. units. They are available through TEN-TEC for \$.50 each.

DIAL CORD REPLACEMENT

The dial string mechanism consists of two parts, a .020" diameter dacron, non-stretchable string and an elastic cord. The diameter of the dacron is important for proper pointer readout, since it is wound on the tuning shaft and carries the pointer across the scale. Replace only with a string of the same diameter. The stretchable section provides string tension. Both are available from TEN-TEC for \$.25. To install, remove the front panel as described below. Attach the lug end of the stretchable section to the #4 screw near the dial bulb. Turn the main tuning shaft fully counterclockwise. Knot the dacron

string around the small pin in the tuning shaft and put on one turn, counter-clockwise. (String should lead off from the bottom of shaft toward upper right corner of panel.) Run string around the two nylon pulleys to the right of the S-Meter and then left, across the top of the panel toward the RESONATE control. Temporarily tape the end to the panel to hold it in position. Now run the elastic cord toward RESONATE control, under lower pulley to right of the RESONATE control, up and over the top pulley. Thread the free end through the left top hole in the dial pointer and secure with a small wire band so that without any stretch in the cord, the pointer is positioned approximately one inch to the left of the flat headed screw located at the upper right of the RESONATE control. Cut off any excess cord. Attach the dacron string through the right hole in the dial pointer and knot it so that the pointer is exactly over the flat headed screw when the shaft is full CCW. This will preload the stretch cord by one inch.

Make sure that the string around the shaft is in the groove and as close to the sub-panel side as possible. As the shaft is rotated clockwise, the string should wind evenly in the groove. If the pointer tends to ride away from the panel at the bottom, rotate it several times on the horizontal axis to pre-load it with twist in the string.

DIAL CALIBRATION

- 1.) The dial string pointer is meant only as a turns indicator for the linearly calibrated 0-100 kHz permeability tuned oscillator dial. Although the string pointer is set accurately at the time the transceiver leaves the factory, it may, in time, vary slightly from the zero setting due to string slippage and stretch.
- 2.) The PTO oscillator dial skirt is attached to the control shaft by means of a friction clutch. By holding the knob firmly, the skirt can be rotated to calibrate it to zero setting when using a crystal calibrator, or WWV as described below. At the time of shipment, the skirt is accurately set. However, if in turning the black tuning knob the fingers touch the skirt with any force, the skirt may deviate from its true setting. Caution should be used when tuning the transceiver so that only the black knob is grasped.
- 3.) To re-calibrate the dial with the aid of a crystal calibrator, loosely couple its output to the antenna so that a signal is picked up at any convenient 100 kHz setting. Zero beat the signal with the main tuning knob. Then hold the knob and rotate the skirt to the zero setting.
- 4.) If no crystal calibrator is handy, WWV at 15 MHz can be received and used for calibration as follows: Set band switch to the 21 MHz position. Rotate RESONATE control, not to its normal 21 MHz position, but counter-clockwise to the 3.5 MHz segment until the noise level increases. Turn main tuning so that lower band edge is tuned in, (zero on 0-5 scale). Around this position, WWV will be heard if within range. Zero signal in with main tuning knob and set skirt of dial as above.
- 5.) The skirt markings are in kHz for all bands except the 28 MHz band. On this band, the tuning ratio is increased four times, so that the true frequency increment is four times that indicated by the skirt readout. Thus, one rotation of the skirt dial represents 400 kHz on this band.
- 6.) If it is necessary to realign any of the bands for position or linearity, refer to the section covering the oscillator.

DISASSEMBLY

1.) REMOVAL OF TOP

Remove the two screws at the extreme edges of the rear of the top. Slide the top back and out of the grooves in the side panels. It is recommended that the speaker wires be disconnected from the speaker to eliminate any possibility of damage during service.

2.) REMOVAL OF BOTTOM PLATE

Remove the four screws in the bottom plate. Slide the bottom back and out of the grooves in the side panel.

This should be sufficient for any alignment necessary on the circuitry.

3.) FRONT PANEL REMOVAL

Dial cord, pilot light and switch linkage are behind the front panel.

Remove the knobs and dial skirt. It is a friction fit to the VFO shaft and can be removed by pulling away from the front panel. Remove the four screws in the bottom of the front panel. Loosen one side panel "Z" bracket. The "Z" brackets are located at the top of each side panel and are secured to the sub-panel. Carefully lift the front of the side panel and slip out the front panel.

4.) DIAL SKIRT REMOVAL AND REPLACEMENT

The main tuning dial skirt is friction mounted to the shaft and can be easily removed by pulling it straight off the shaft after the plastic knob is removed. The felt washers between knob and skirt provide a slight amount of friction to eliminate any backlash between the two.

To replace the dial skirt, either a specially constructed tool as shown below, or a screwdriver with a blade width of approximately $9/32$ " can be used. With the tool, spread the "D" spring on the skirt hub so that the straight portion does not show through in the hub bore. If the tool tip shows in the bore, this is OK for now. Start the skirt on the shaft, with the tool handle pointing downward in relation to the front panel. This puts the handle of the tool out in the open. Push the skirt on the shaft until the tip of the tool in the hub bore hits the brass portion of the two diameter shaft. While maintaining inward pressure on the skirt, slowly remove the tool from the groove by using a rotational motion on the handle. As the tip is pulled from the hub bore, it will allow the skirt to be pushed on the shaft before the spring can regain its unstressed condition. Seat the skirt as far as it will go.

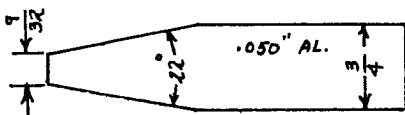

Dimensional details
of insertion tool.

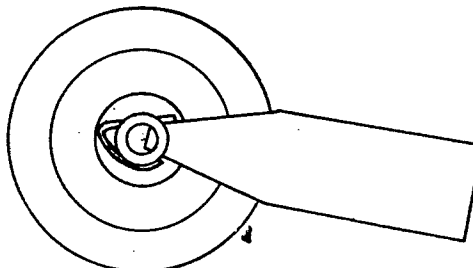

Rear view of dial skirt
with tool inserted.

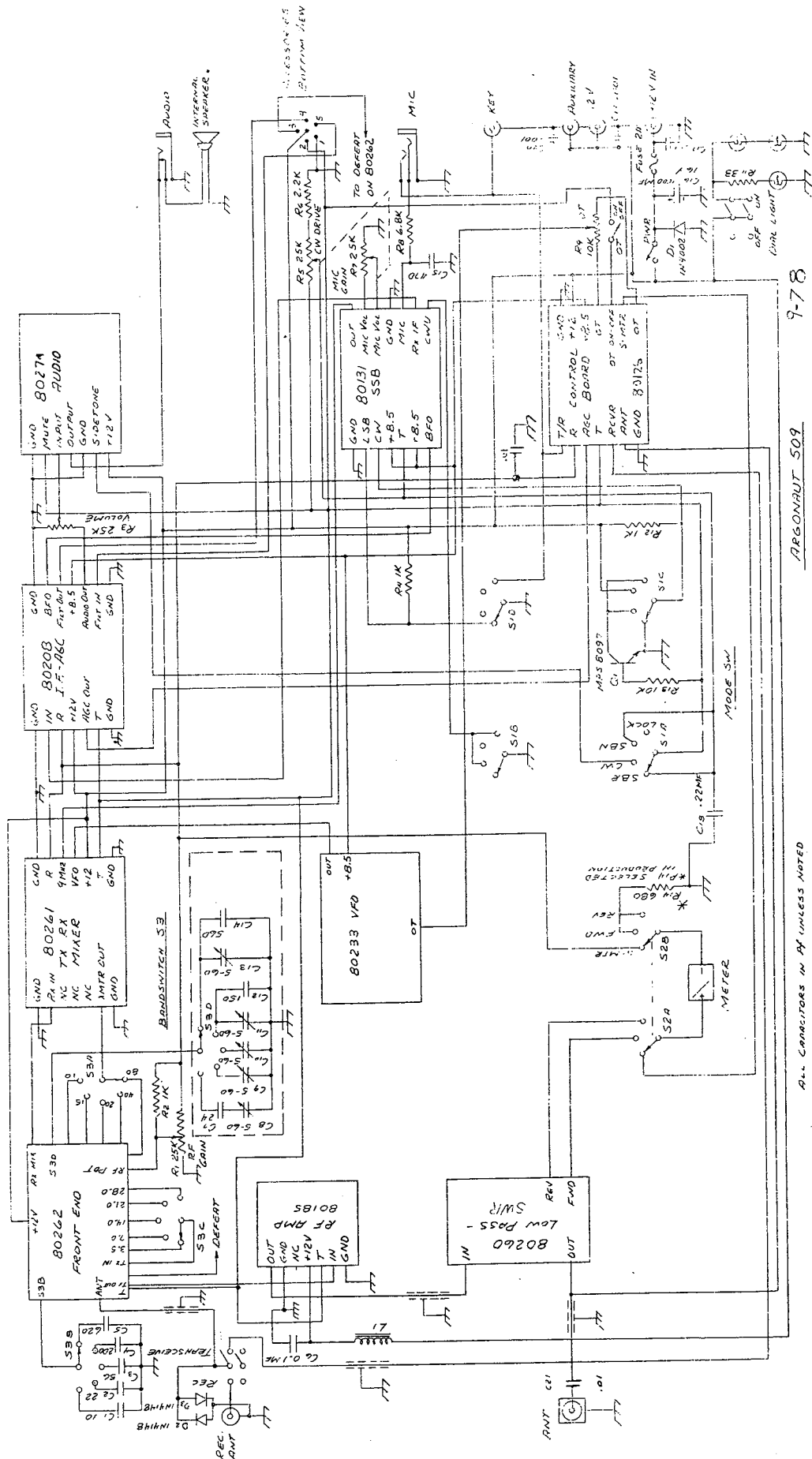

9-78

ARGONAUT 509

ALL CAPACITORS IN μ F UNLESS NOTED

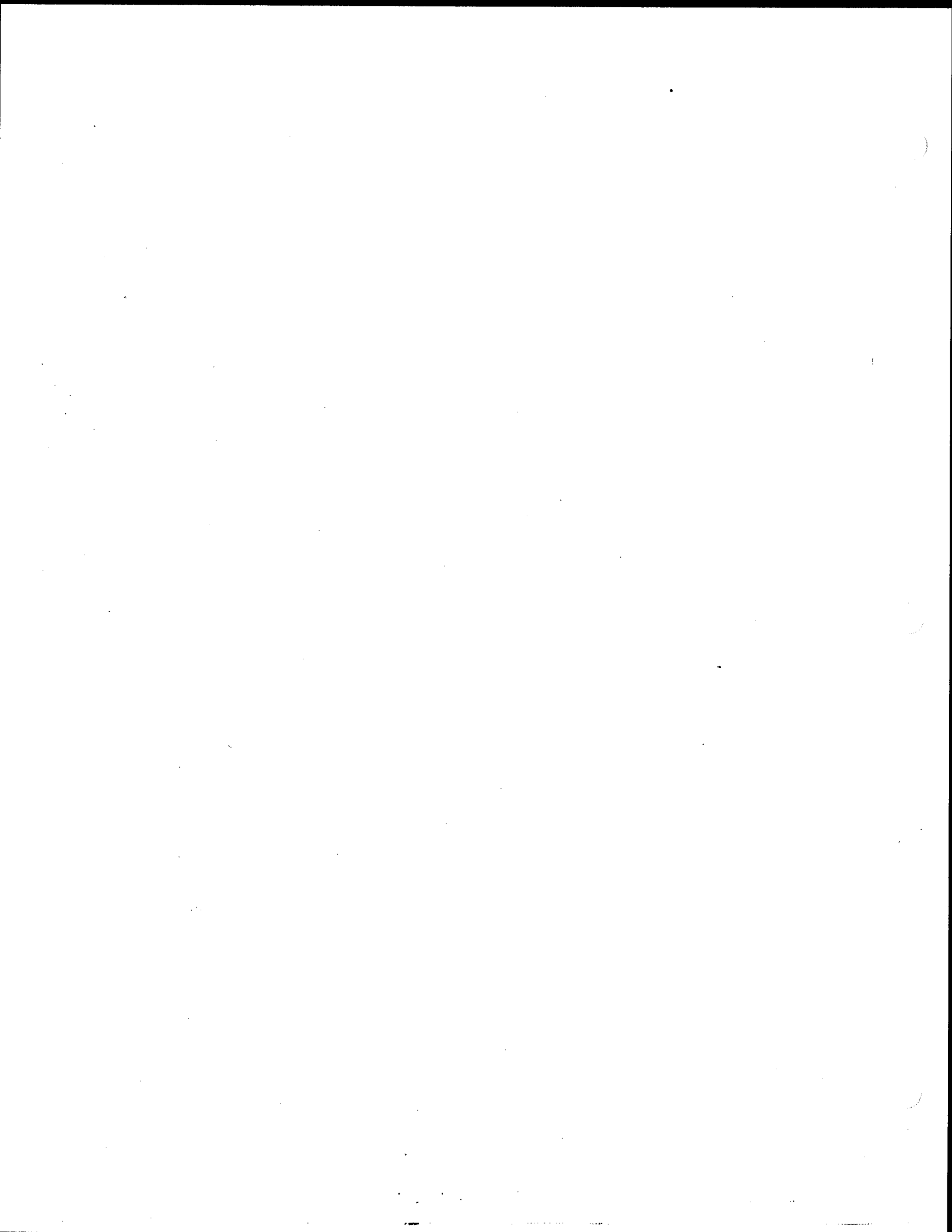

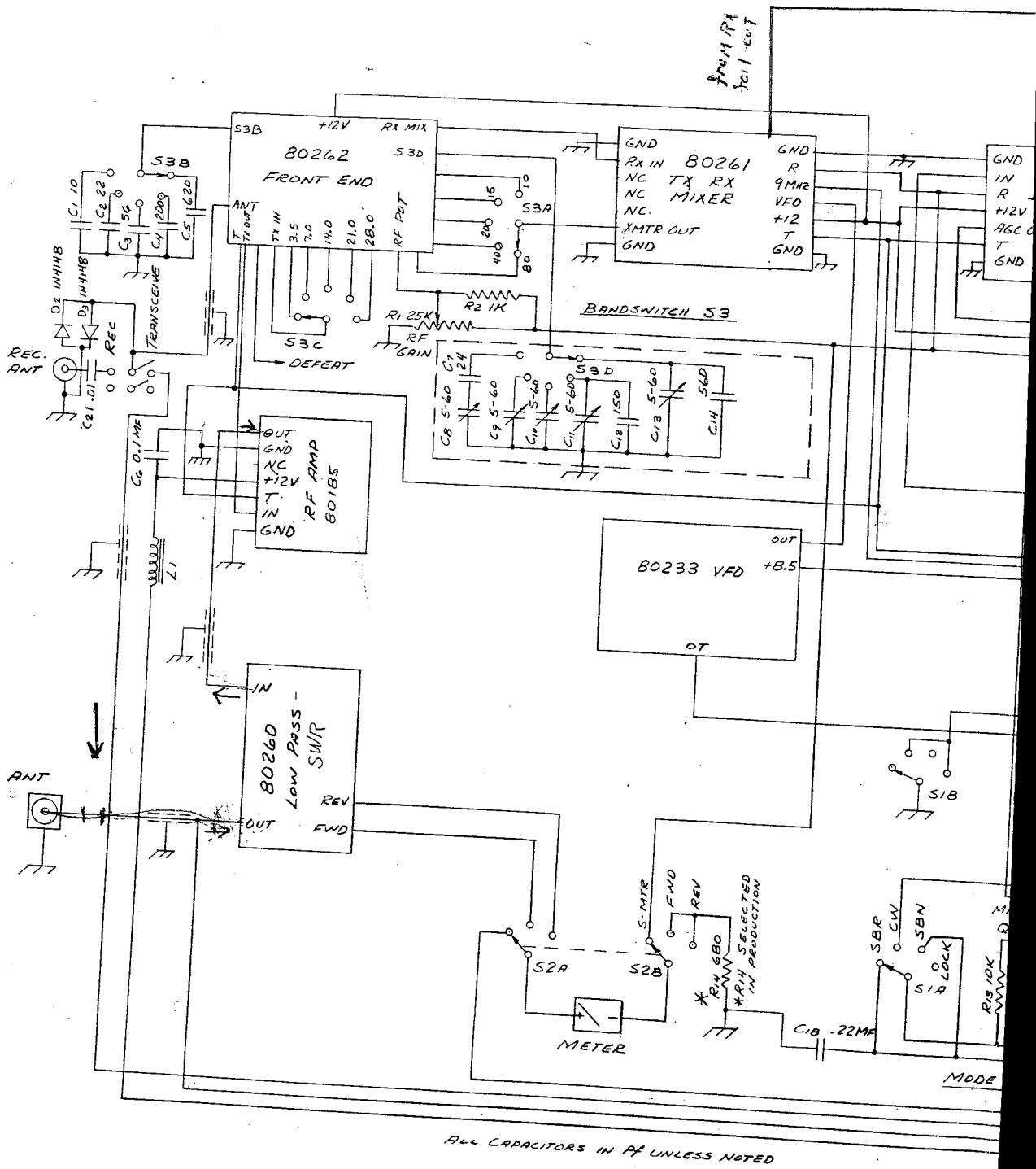

5-77

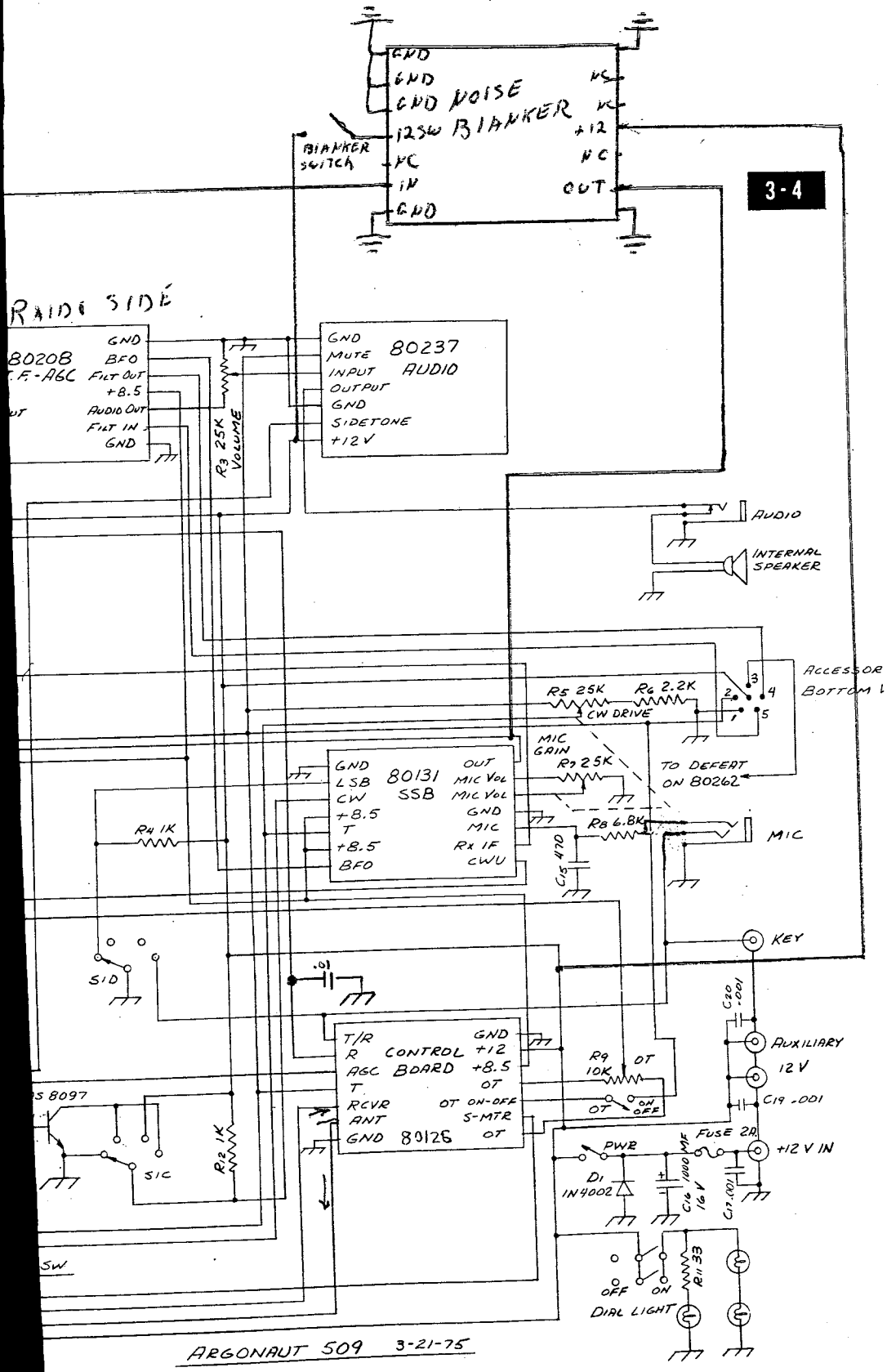

+ VOLTAGE - ~~GRAY~~
 12V - Red
 Defeat - Purple

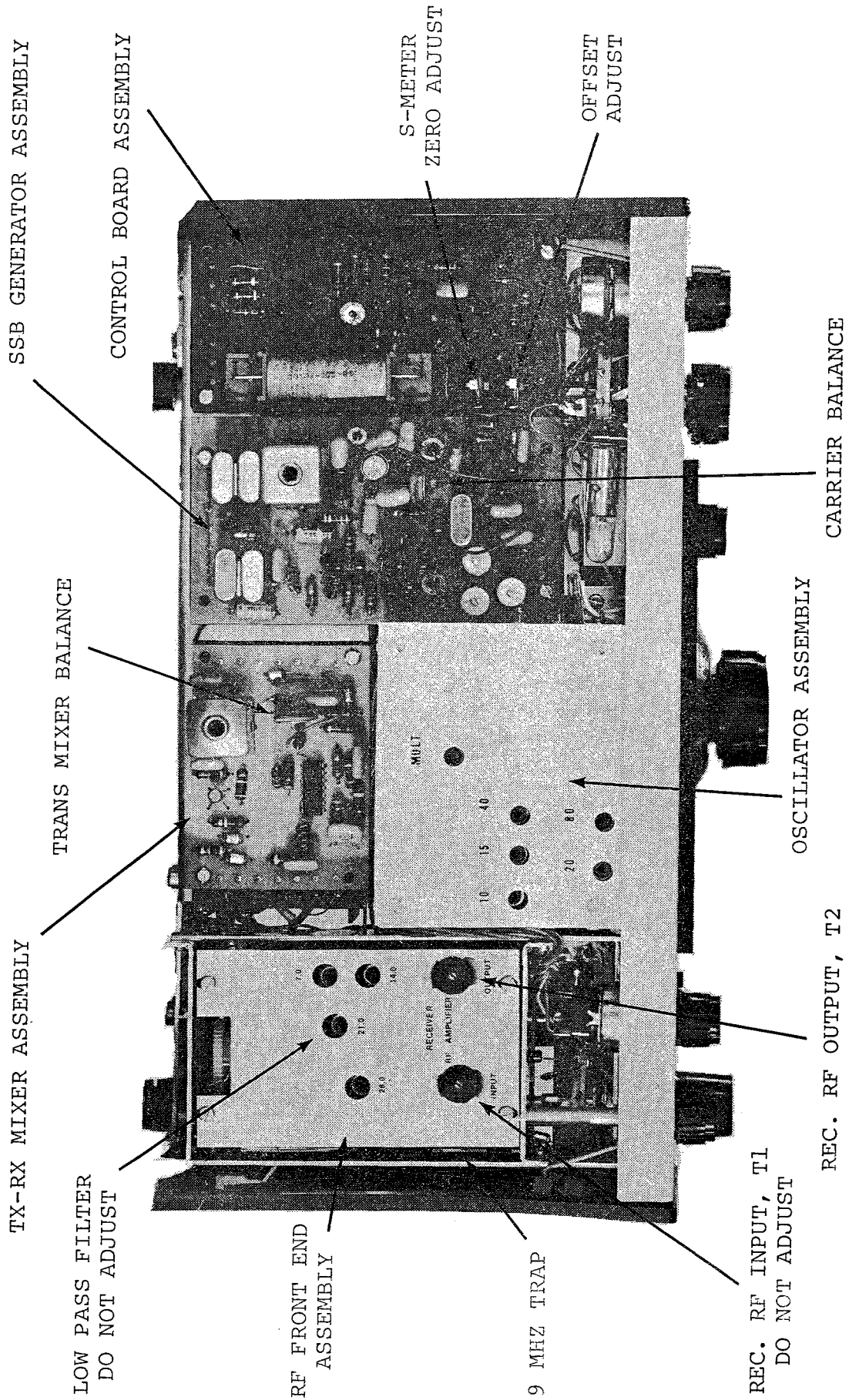
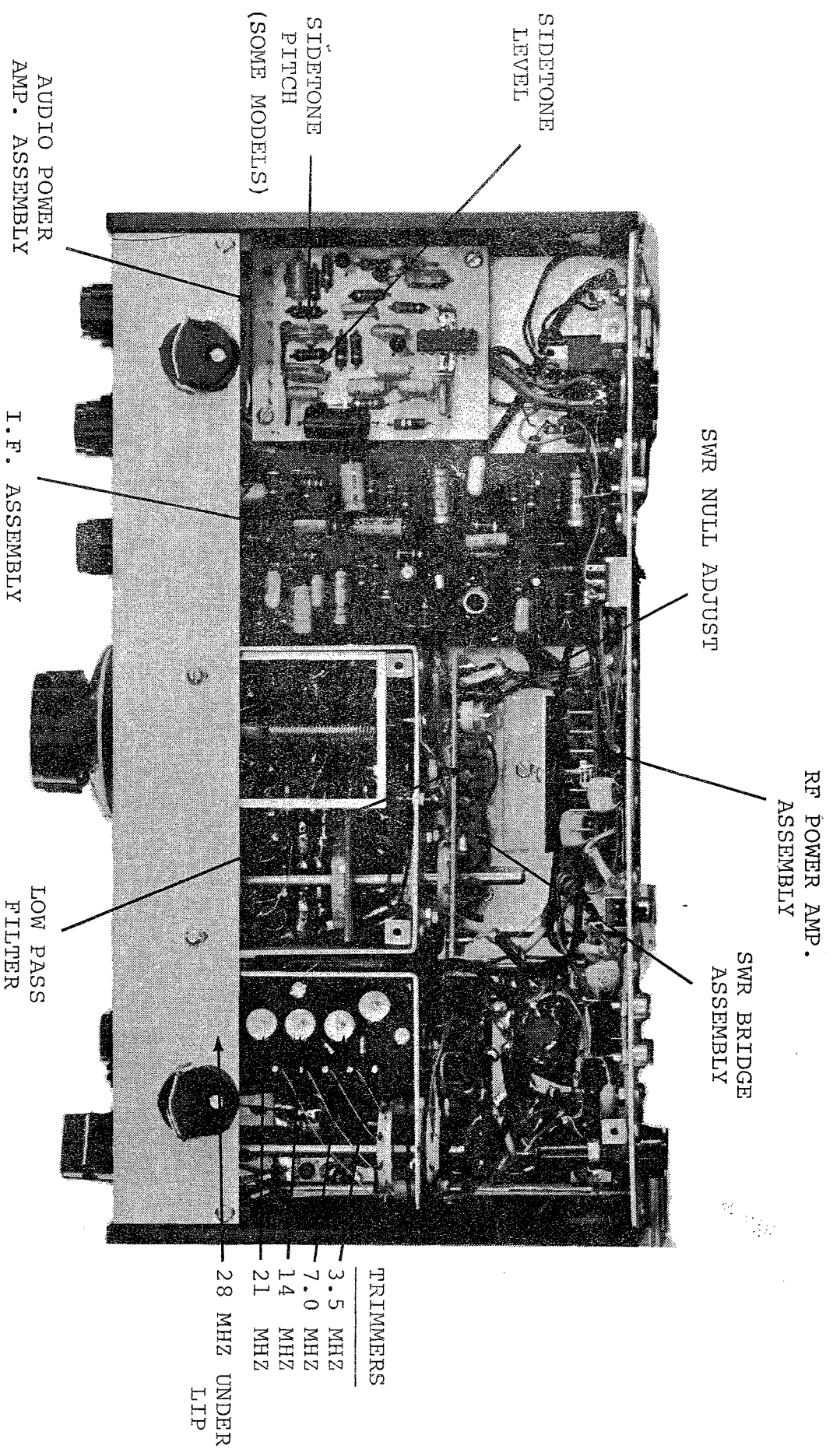

FIGURE 1 - TOP VIEW



TRIMMERS
 3.5 MHZ
 7.0 MHZ
 14 MHZ
 21 MHZ
 28 MHZ UNDER
 LTP

FIGURE 2 - BOTTOM VIEW

80262 FRONT END

RECEIVER R.F. AMPLIFIER

The rf amplifier in the receiving section is located on the FRONT END sub-chassis containing the permeability tuning rack. This subassembly is a part of the main chassis. It consists of a single stage dual gate MOSFET, Q1. Antenna coil, T1, and mixer coil, T2, are gang tuned with the mechanical rack mechanism. The corresponding capacitors are not included on the PC board. A set of five fixed capacitors are switched across T1, and a set of five trimmer capacitors, located on a separate board under the amplifier board, are switched across T2.

The stage is powered from the rf pot terminal, which is nominally 10 to 12 volts at full rf gain. The AGC system decreases this voltage as signal level increases, thereby decreasing the stage gain. The RF control also varies this voltage.

To align the tuned circuits, proceed as follows:

- 1.) Connect a Ballantine or other suitable ac meter to the receiver audio output.
- 2.) Connect a signal generator to the antenna. Set bandswitch to 3.5 MHz. Frequency to 3.5 MHz.
- 3.) Temporarily connect a .01 uF capacitor from the 3.5 MHz trimmer to ground. (Figure 2) Set signal generator level to several hundred microvolts and tune it to 3.5 MHz. Rotate the RESONATE control for a peak on the ac meter. Disconnect the .01 uF capacitor, turn the signal generator down to about 1 microvolt and peak the 3.5 MHz trimmer.
- 4.) Set the frequency to 4.0 MHz, connect the .01 uF capacitor, turn up signal generator and tune it until a signal is heard at 4.0 MHz. Rotate the RESONATE control for a peak in output. Disconnect the .01 uF capacitor, turn down the signal generator and peak the rf output coil for maximum output. (Figure 1)
- 5.) Repeat steps 3 and 4 until there is no more increase in output. This aligns and tracks the 3.5 MHz band and transformer settings for all other bands.
- 6.) Switch to 7.0 MHz, set the frequency to mid-band. (7.15 MHz). Connect the .01 uF capacitor from the 7.0 MHz trimmer to ground. Using the same procedure with the signal generator, locate the signal and peak the RESONATE control for maximum. Remove the .01 uF capacitor, turn down the signal generator and peak the 7.0 MHz trimmer for maximum output.
- 7.) Using the same procedure, align the 14.0, 21.0 and 28.0 MHz bands at 14.2, 21.2 and 29 MHz.

9 MHZ TRAP

- 1.) Set receiver to 7.0 MHz band and the RESONATE control for maximum output.
- 2.) Without changing the settings, tune signal generator to 9 MHz and increase signal out until a signal is heard. Tune trimmer C2 for a null. This capacitor is located on the top of the board and is accessible with a long narrow screwdriver inserted between the rack top plate and the side of the sub-chassis, near the INPUT, T1, transformer. (See Figure 1)

TRANSMITTER DRIVER AND FILTERS

This assembly also carries the transmitter driver stages and a set of wide band-pass filters that are switched into the input terminal of the driver stages

via switch S3C. The transformers are factory tuned and should require no field adjustments. Since they are overcoupled transformers, they require an elaborate sweep generator setup for adjustment, and so it is recommended that field adjustment be avoided.

The transmitter drivers consist of Q2 and Q3, which are RC coupled and biased to the "on" condition with the application of the "T" voltage to the bias line.

Transistor Voltages - (RF gain control fully clockwise.)

Q1 MOSFET		T	R
Drain, Pin 1		0.15	8.5
Gate 2, Pin 2		.05	3
Gate 1, Pin 3		.05	0.8
Source, Pin 4		0.15	2

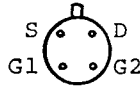

Transistor	Collector		Base		Emitter	
	Transmit	Receive	Transmit	Receive	Transmit	Receive
Q2	10.5	13	1.3	0.1	0.5	0
Q3	13	13	1.1	0.1	0.4	0

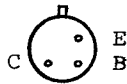

Pins viewed from bottom of circuit board.

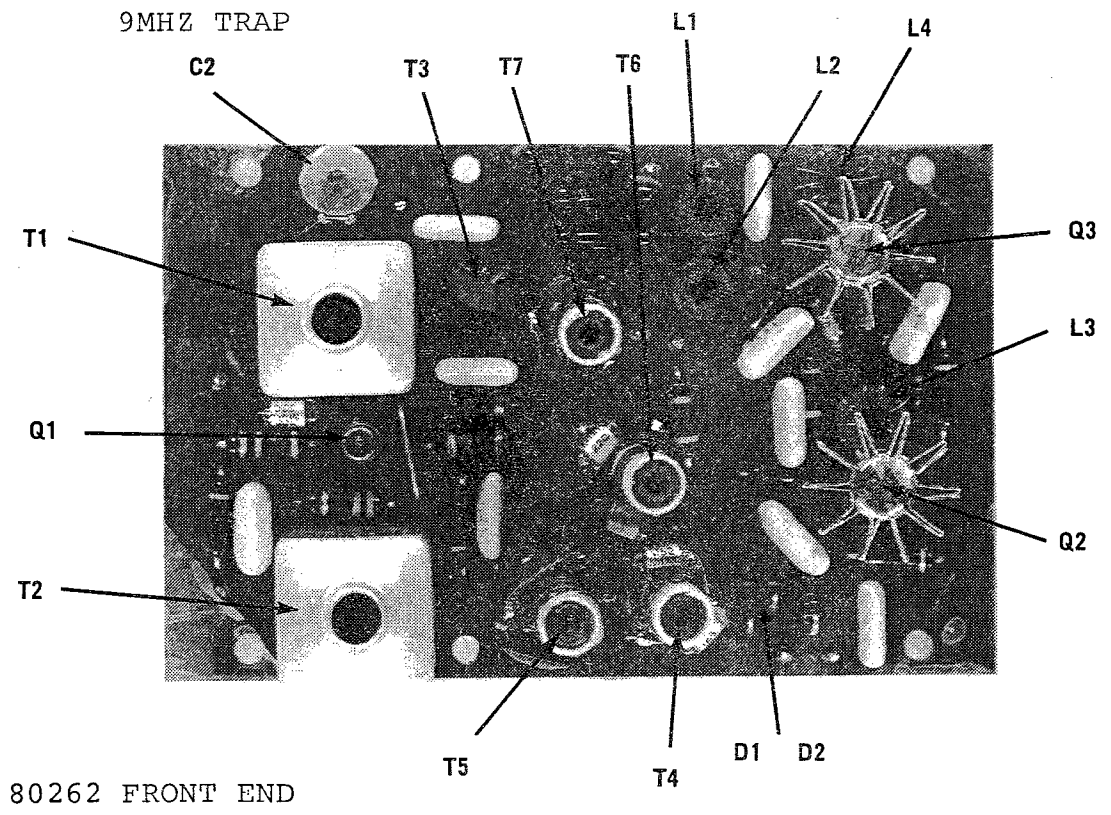
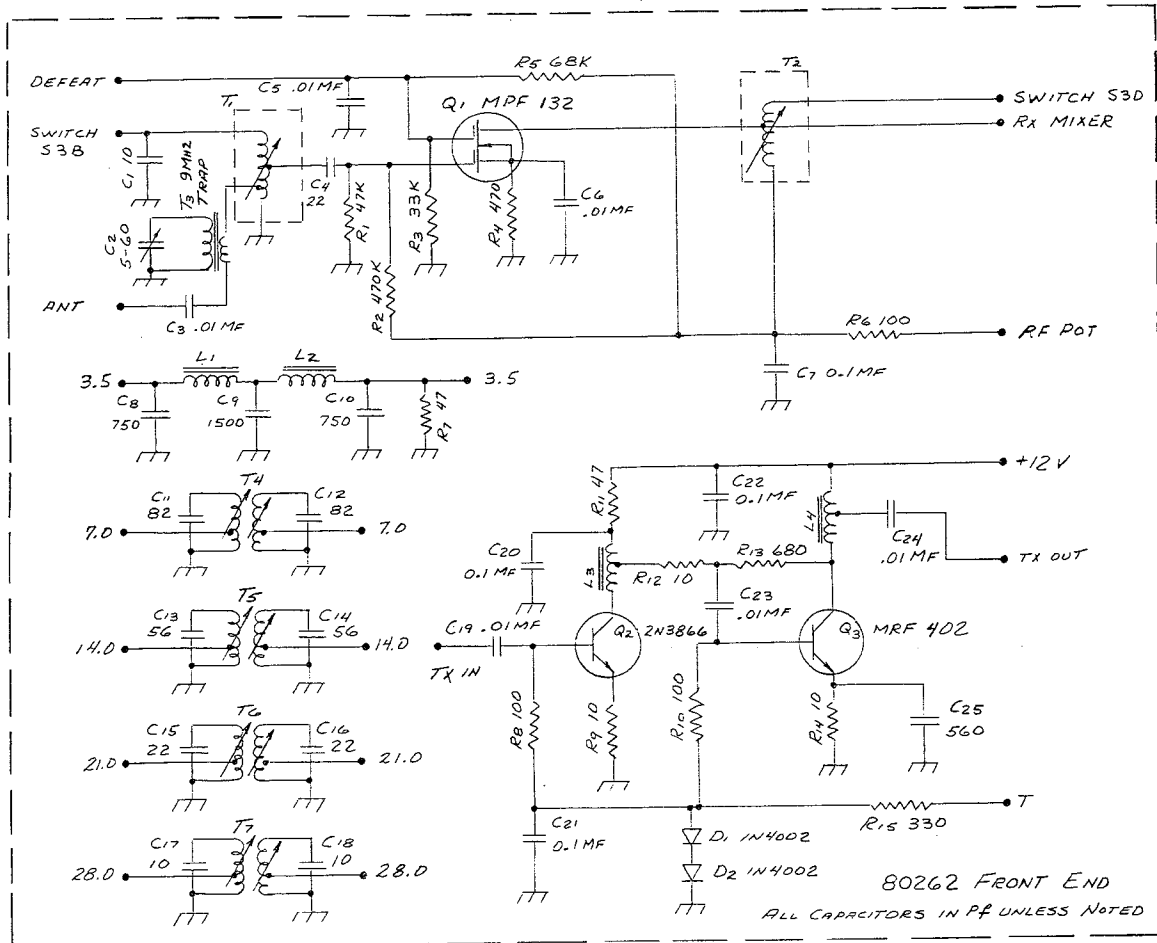

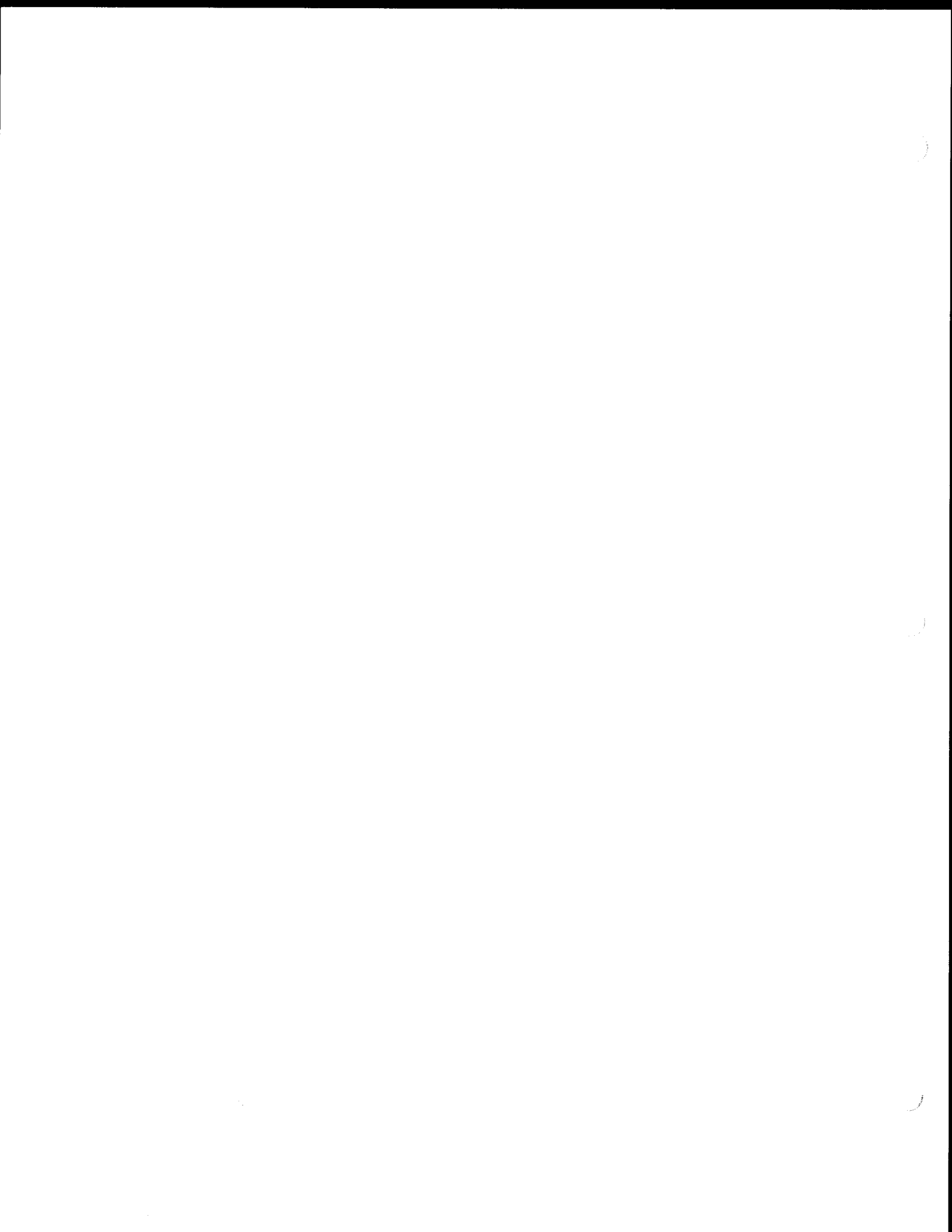

80233 OSCILLATOR

The variable oscillator produces the proper injection frequencies for the transmitter and receiver using a 9 MHz i.f. system. Q1 is the basic oscillator followed by Q2 and Q3 as buffers. Transistor Q4 is used as a multiplier. Off-set tuning has been incorporated using the junction capacity of D1 as the capacitor.

Tuning is accomplished by varying the inductance of L11. The proper frequencies are obtained by changing the basic oscillator frequency and by using the correct multiple. Table I shows the basic frequency, multiple and injection frequency.

<u>TABLE I</u>	BAND	BASIC FREQUENCY MHz	MULTIPLE	INJECTION FREQUENCY MHz
	3.5	6.250-6.500	X2	12.5-13.0
	7.0	5.333-5.500	X3	16.0-16.5
	14.0	5.000-5.500	X1	5.0- 5.5
	21.0	6.000-6.250	X2	12.0-12.5
	28.0	6.333-7.000	X3	19.0-21.0

The basic frequencies for all bands are close together. Therefore, the linearity of tuning is maintained on all bands. The frequency range and band edge can be adjusted with coils L1 through L10. For instance, on 80 meters, to increase the tuning range, increase the inductance of L2 (move bottom slug CCW) and decrease the inductance of L1 (move top slug CCW). To decrease the range the procedure is reversed (move both slugs CW). The same procedure holds for 40 through 10 meters. All coils L1 through L10 are located beneath the openings in the top cover.

MULTIPLIER TUNING

Set the oscillator to 10 meters and the frequency to 6333 kHz. Peak both the bottom and top slugs in T1 for 19 MHz. Set the oscillator to 7000 kHz and check the output. It should be close to that obtained at 19 MHz. If necessary, repeak the top slug slightly. This is an over coupled double-tuned transformer and will require a little care in obtaining the proper passband. When properly tuned it should peak toward each frequency extreme with a shallow dip in the center. The other bands are tuned with the trimmer capacitors located on the circuit board. It is important that 10 meters is properly adjusted before proceeding with other bands. Switch the oscillator to 15 meters and the frequency to 6.000 MHz. Peak both C18 & C20 for 12.0 MHz and check the output. The multiplier passband is set to pass both 80 and 15 meters. This will be a frequency range of 12.0 to 13.0 MHz. The two peaks of the over-coupled transformer will fall at 12.0 and 13.0 MHz. The output at the high frequency end of 15 meters should coincide with the output at the low frequency end of 80 meters and will be about 3 dB below either extreme. Switch to 80 meters and check the output at 13.0 MHz. If necessary, repeak C20 for maximum. On 40 meters, the multiplier only has to pass 16.0 to 16.5 MHz. It is only necessary to set the frequency to 5.367 MHz and peak both C17 and C19 for maximum output at 16.1 MHz. This should provide the proper injection across the 40 meter band.

The OFFSET tuning range will vary from band to band due to the multiplier. For a voltage swing from +3V to +6V it will vary approximately ± 2 kHz on 20 meters, ± 4 kHz on 80 and 15 meters and approximately ± 6 kHz on 40 and 10 meters.

VOLTAGE READINGS

	COLL	BASE	EMITTER
Q1	7.6	2.2	2.2
Q2	5.2	1	0.4
Q3	7.6	3.6	3.1
Q4	6.2	1	1.5

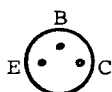

Pins viewed from bottom of circuit board.

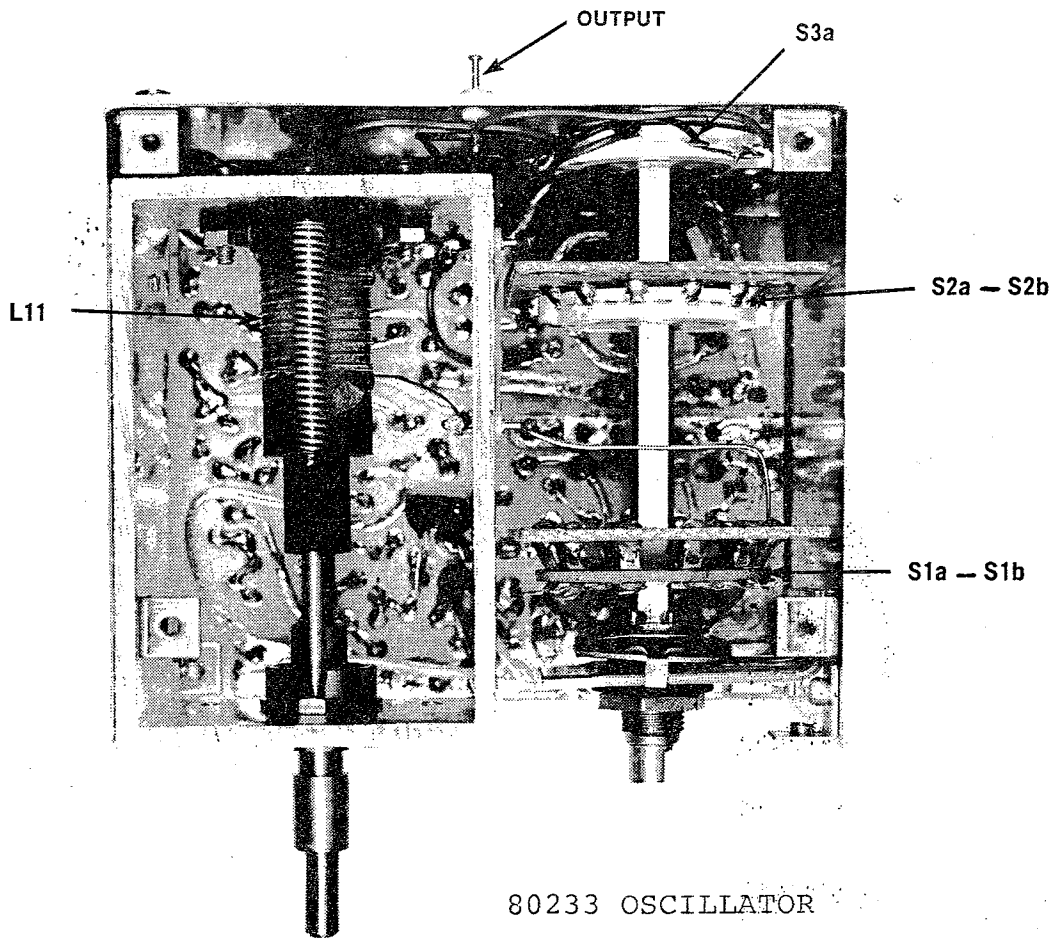
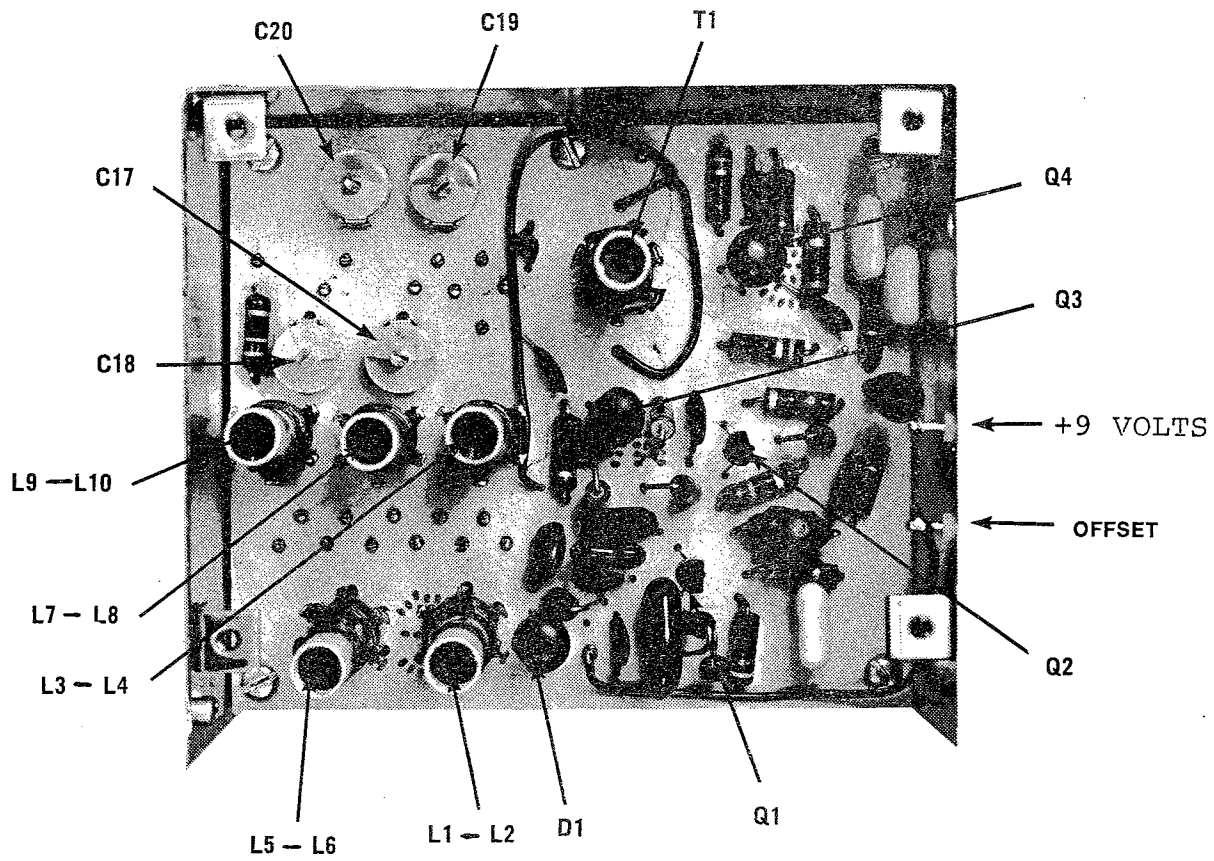

8023 OSCILLATOR

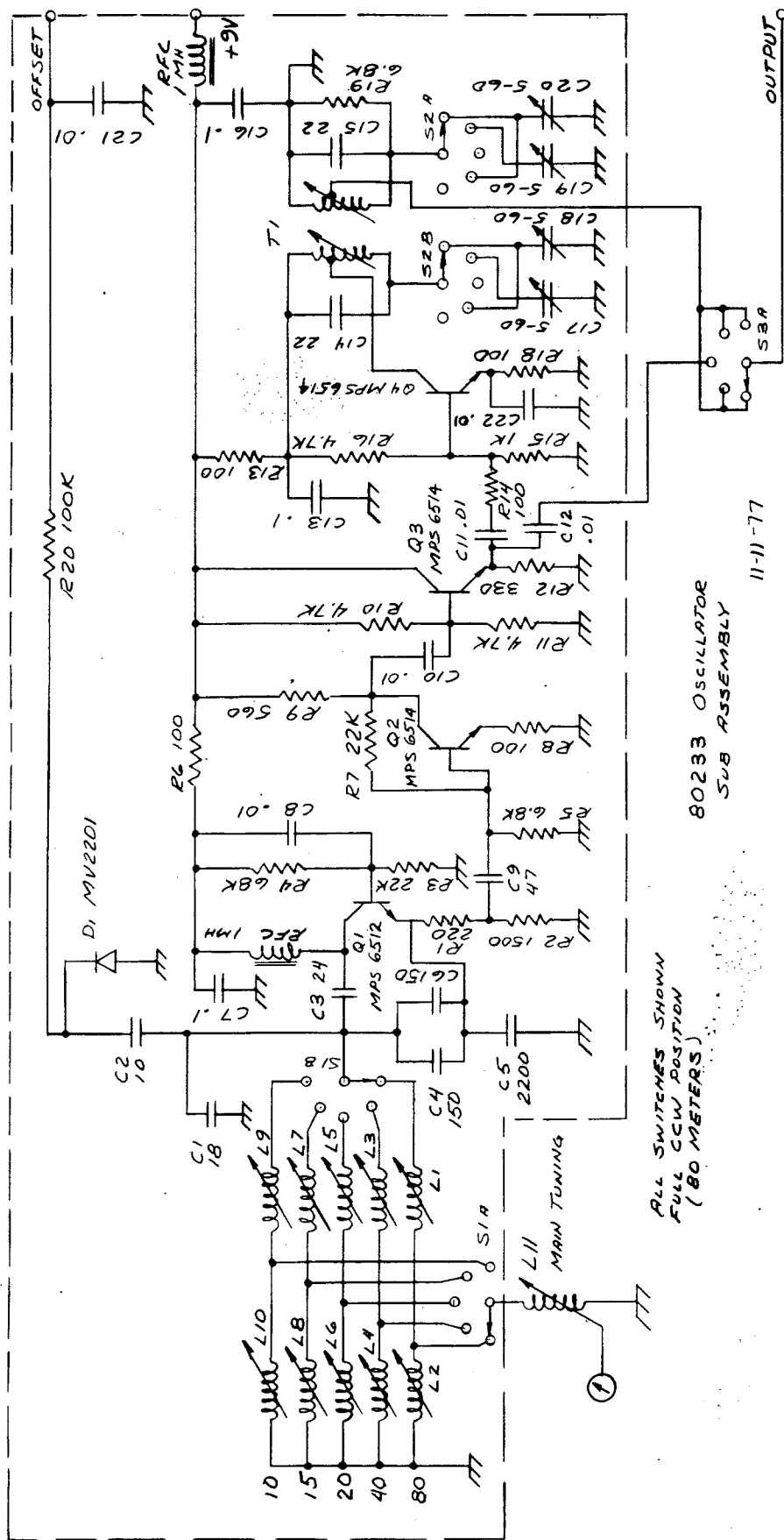



80261 TX-RX MIXER

The receiver mixer is built around a protected gate field effect transistor. The input is untuned and brought out to a terminal through a 470 pF capacitor. The output is a single tuned circuit lightly coupled through a 22 pF capacitor to the output pin. This provides a good match to the crystal filter which has 470 ohm input impedance.

The transmitter mixer consists of a differential, double balanced integrated circuit. The output of the balanced mixer is loaded with a center-tapped coil and output is taken from one side. Balance potentiometer R7 should be adjusted for minimum VFO feed through on odd harmonics.

The two mixers are interconnected on the circuit board so there is only one terminal for the 9 MHz crystal filter and one terminal for the VFO injection. The receiver mixer positive voltage is brought out to the "R" terminal. It is switched to ground during transmit to eliminate any tendency for interaction between mixers. The transmitter mixer bias is brought out to the "T" terminal. It is switched to ground when in the receive mode.

Pin Voltage Readings - (No signal conditions, SB-N mode.)

Pin	Transmit	Receive	Pin	Transmit	Receive
GND	0	0	GND	0	0
RX	0.1	9	R	0.2	9.5
NC	-	-	9 MHz	0	0
NC	-	-	VFO	.05	.05
NC	-	-	+12	13	13
TX	0	0	T	9	0
GND	0	0	GND	0	0

Transistor Voltage Readings

Q1

Pin	Transmit	Receive
1-Drain	0.2	9.5
2-Gate 2	0	0.8
3-Gate 1	0.1	1.4
4-Source	0.1	1.4

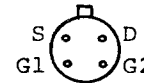

Pins viewed from bottom of PC board.

IC-1

Pin	Transmit	Receive	Pin	Transmit	Receive
1	3.5	3.6	8	6.5	6.9
2	2.8	3.3	9	NC	NC
3	2.8	3.3	10	6.5	6.9
4	3.5	3.7	11	NC	NC
5	2.8	0	12	12.5	13
6	12.5	13	13	NC	NC
7	NC	NC	14	0	0

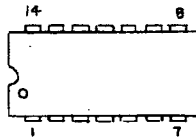

Integrated Circuit pins viewed from top of PC board.

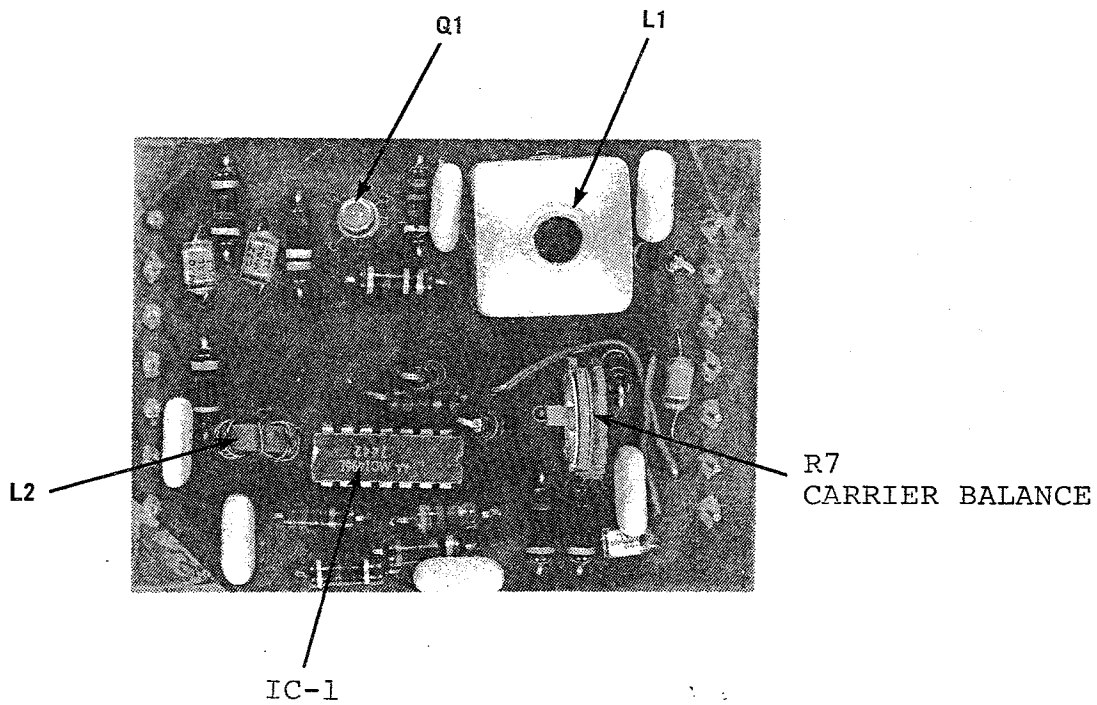
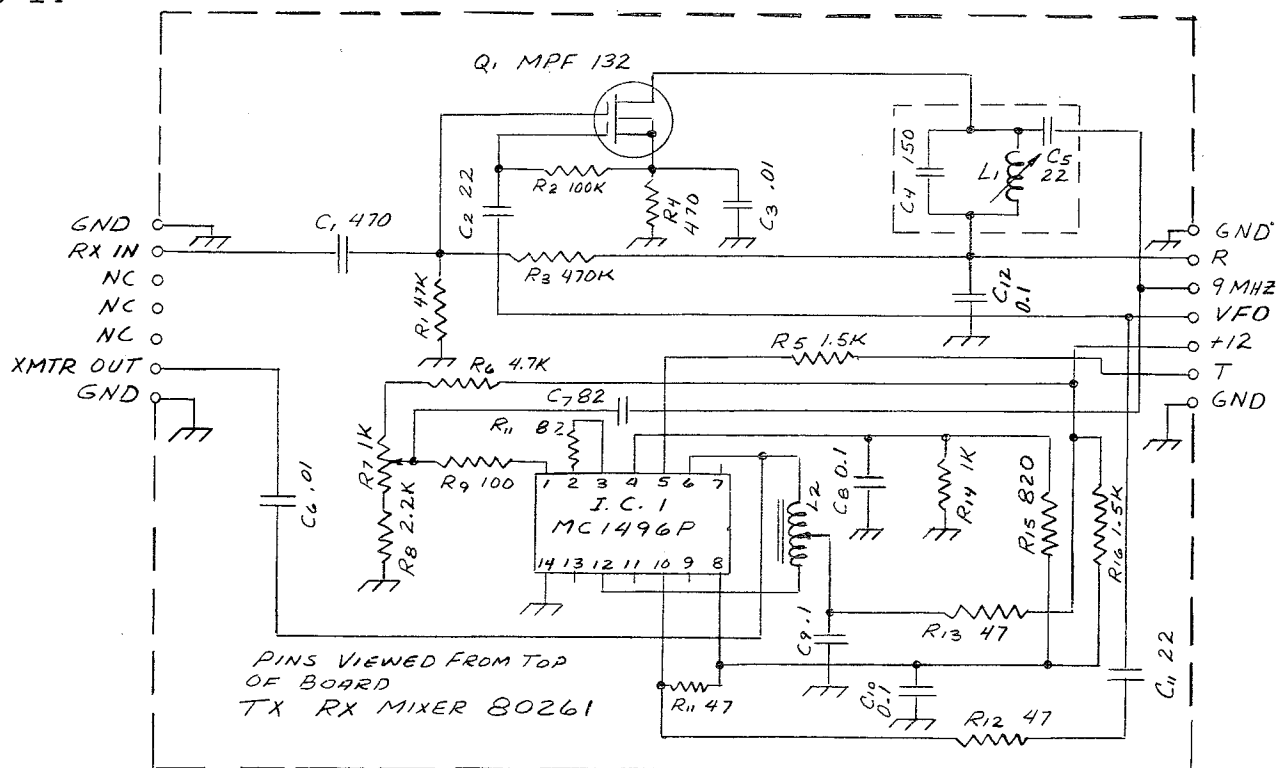

80208 I.F. BOARD

The 9 MHz i.f. amplifier is a single stage consisting of Q1 and transformer T1. The input is not tuned. The output of the i.f. stage feeds a low distortion product detector, Q2. The recovered audio is amplified by transistors Q3, Q4 and Q5. The output of the audio preamplifier drives an audio derived AGC transistor, Q6. Transistor Q7 is used to clamp the AGC line to ground during transmit. This eliminates any tendency of receiver blocking caused by stray rf in the AGC circuit. Model 208 CW filter, when used, is inserted between Q3 and Q4.

Pin Voltage Readings - (Readings under no signal conditions.)

Pin	Transmit	Receive	Pin	Transmit	Receive
GND	0	0	GND	0	0
IN	0	0	BFO	5.5	5.5
R	0.2	9.5	FILTER OUT	0	0
+12	13	13	+8.5	8	8
AGC OUT	0	0.4	AUDIO OUT	0	0
t	9	0	FILTER IN	0	0
GND	0	0	GND	0	0

Transistor Voltage Readings

Transistor	Collector		Base		Emitter	
	Transmit	Receive	Transmit	Receive	Transmit	Receive
Q1	13	12.5	0	1.5	0	0.8
Q3	4.7	4.5	0.6	0.6	.05	.05
Q4	2	2.2	0.6	0.6	.05	.05
Q5	4	4	2	2.2	1.3	1.3
Q6	13	13	4	4	3.4	3.4
Q7	0	0.3	0.6	0	0	0
Q2 Source = 1.5		Drain = 12	Gate 1 = 0.65		Gate 2 = 1.5	

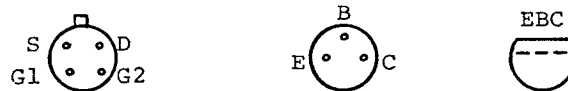

Pins viewed from bottom of PC board.

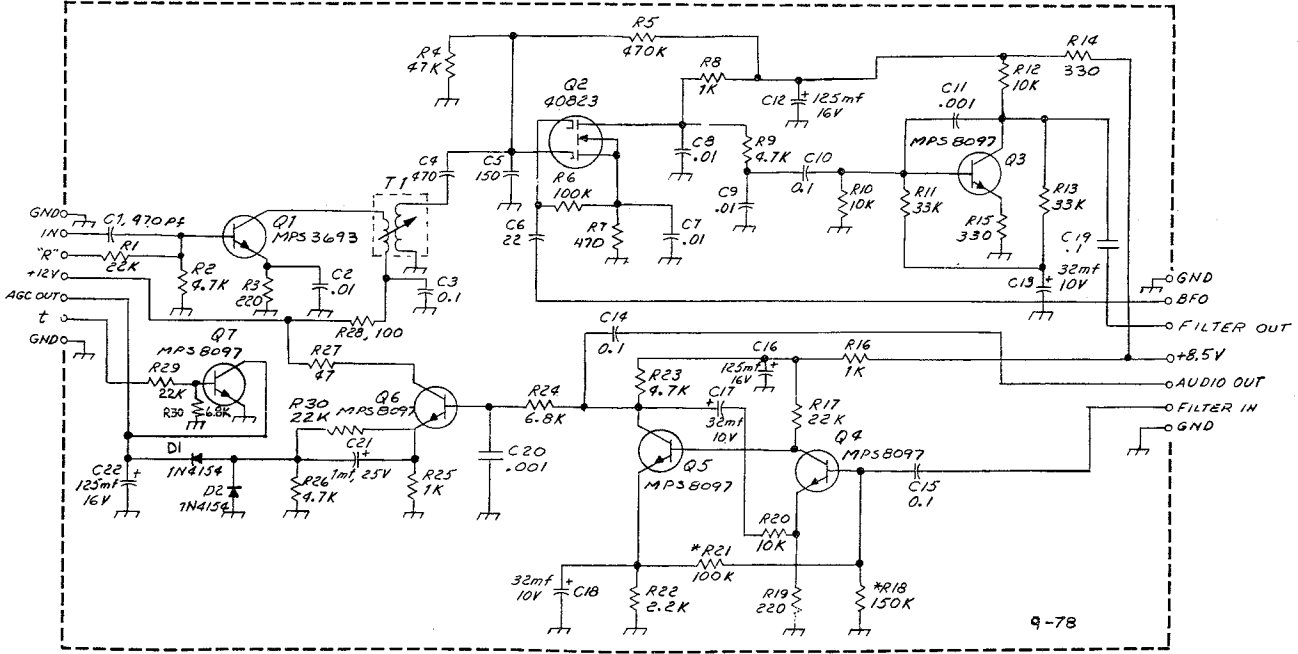

Pins viewed from top of board.

* Adjust for 6 Volts at collector 80208 I.F. BOARD of output, Q5.

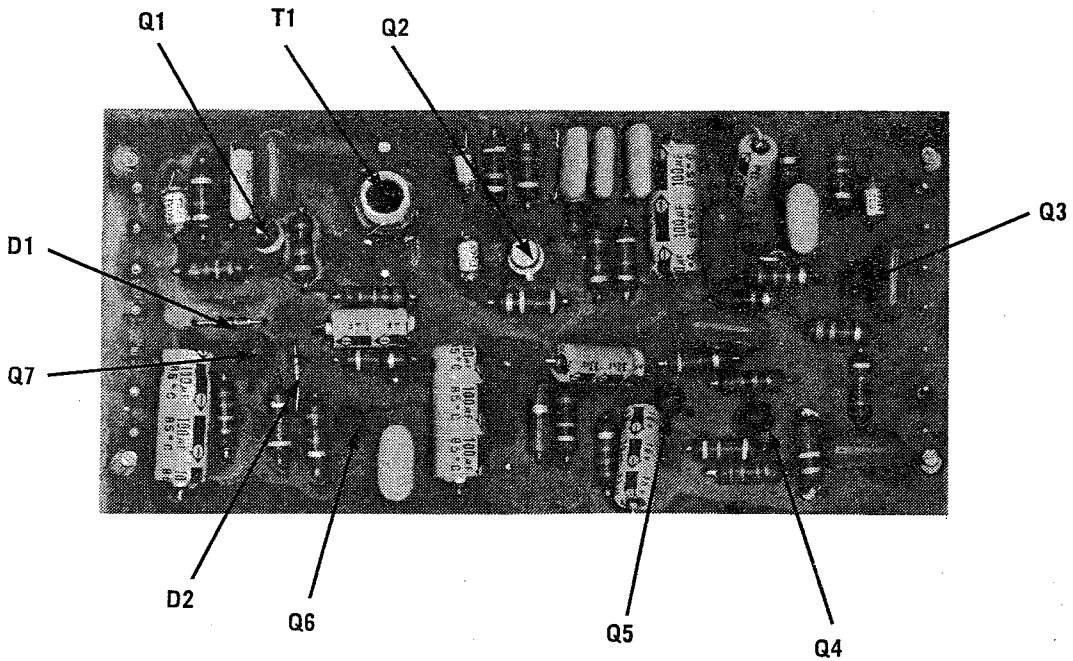

80208 I.F. BOARD

80274 AUDIO POWER AMPLIFIER

Integrated circuit, IC-1, contains the complete audio power and preamplifier. Input is applied to pin 2 and output taken from pin 8. Input signal may be from one of two sources, the received signal which is applied to the INPUT terminal and passes through the muting circuit when open or from the sidetone oscillator consisting of Q2 and Q3.

Input signal is shorted to ground whenever muting transistor, Q1, is put into the conducting state. This occurs in the transmit mode by the application of the "T" voltage to its base circuit through D1. C1, R1 and R2 form a short RC circuit to slightly delay the turn-on time of the audio signal.

The sidetone oscillator is a relaxation type made up of unijunction transistor Q2. C5, in conjunction with R8 and pitch control R7 determine the frequency. Q3 is the turn-on switch, controlled by the application of the SIDETONE voltage to its base. The SIDETONE control voltage is the "T" voltage, but it is applied only in the CW position of the MODE switch. Sidetone level is adjusted by R5. The sidetone signal is prevented from being muted along with the incoming signal by isolating resistor R4.

Pin Voltage Readings - (No signal conditions, CW mode, Drive fully CCW)

Pin	Transmit	Receive
GND	0	0
T	10.4	0.2
INPUT	0	0
OUTPUT	0	0
GND	0	0
SIDETONE	0	0
+12	13.8	13.8

Semiconductor Voltage Readings - (CW mode.)

Transistor	Collector		Base		Emitter	
	Transmit	Receive	Transmit	Receive	Transmit	Receive
Q1	0	0	0.7	0	0	0
Q2	8.3	8.1	4.5	2.4	0	0
Q3	0	0	0.7	0.2	0	0

Integrated Circuit - (CW mode.)

Pin	Transmit	Receive
1	7.0	7.0
2	0	0
6	0	0
7	0	0
8	6.8	6.8
9	0	0
13	0	0
14	13.8	13.8

Tab is ground.

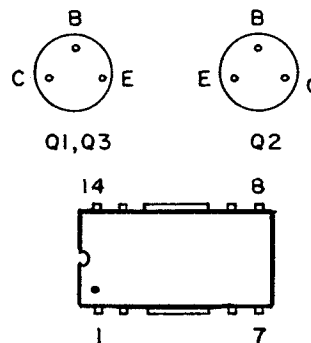

Semiconductor pins viewed from top of PC board.

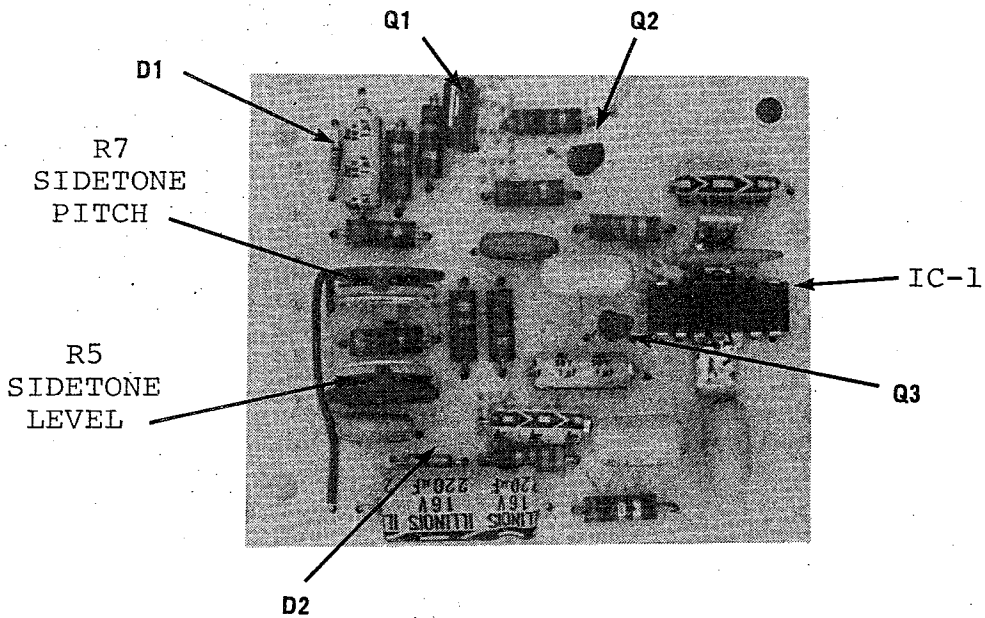
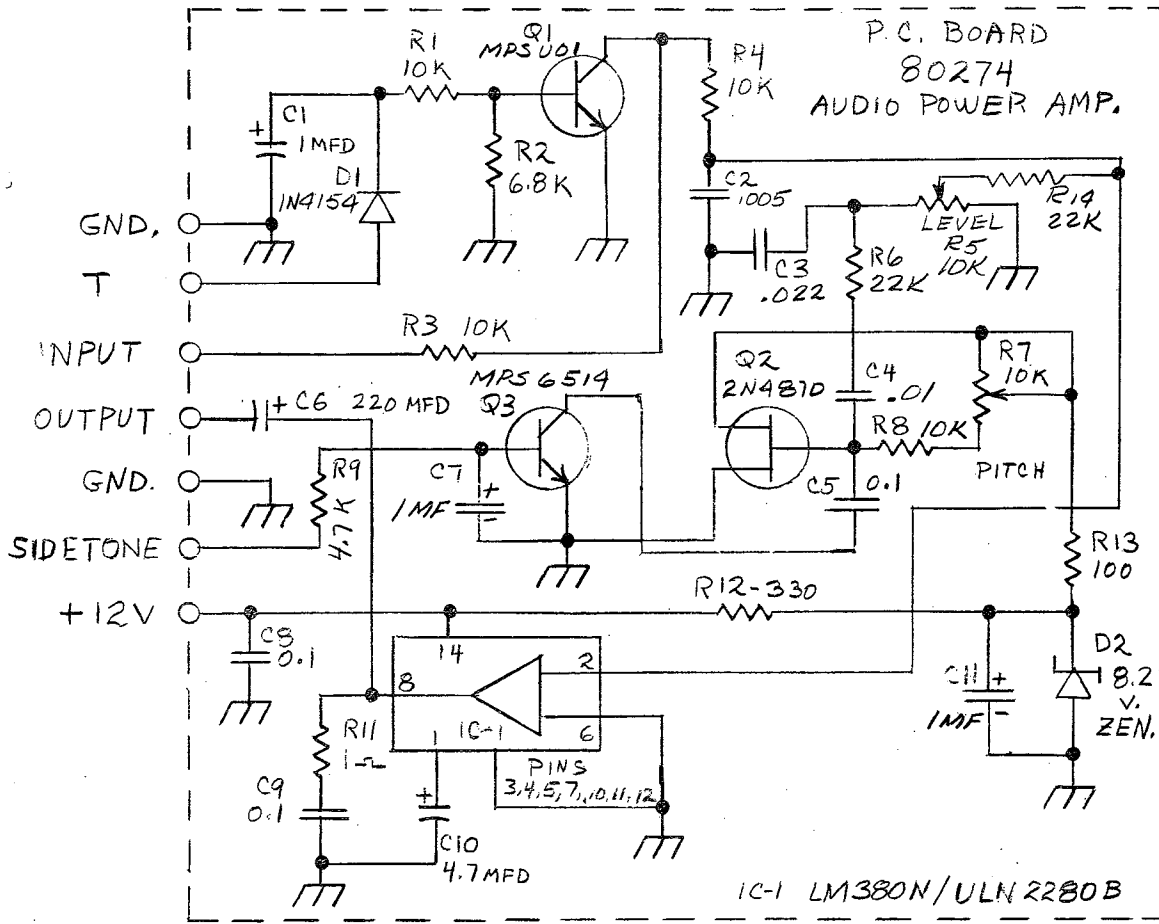

80274 AUDIO AMPLIFIER

80131 SSB GENERATOR

Transistor Q1 operates as a crystal controlled carrier generator. Capacitors C1, C2 and C3 set the crystal to the proper frequency for USB, LSB and CW. Capacitor C1 sets the crystal to the high frequency side of the filter passband. A positive 8 to 12 V at terminals "LSB" and "CW" will cause transistor switches Q2 and Q3 to place capacitors C2 and C3 in the circuit. These capacitors will set the crystal to the low frequency side of the filter passband. Both the upper and lower frequency carriers are positioned approximately 15 dB down on the filter skirts. For CW operation, the "CW" pin is brought to ground with a suitable switch. This removes capacitor C3 and places the generator in the filter passband. Frequency change is approximately 750 Hz. The total output of the oscillator is brought out to a terminal pin for use as a BFO. A portion of this output is fed to the balanced modulator, CA3053. The balanced modulator is an integrated circuit differential amplifier. Using an integrated circuit insures good balance under varying voltages and temperatures. The balanced modulator output passes through a four crystal filter terminated in 470 ohms. Transistors Q4 and Q5 are used as a microphone amplifier. When terminal CWU is grounded (CW and LOCK modes), the modulator is purposely unbalanced to allow the CW carrier to pass through.

Alignment - Proper alignment of the SSB generator requires the use of a frequency counter and either an rf VTVM or oscilloscope with a response extending to 9 MHz. T1 is first peaked in the center of the passband of the crystal filter and then C1, C2 and C3 are adjusted to set the carrier oscillator frequencies to the upper and lower skirts for SSB operation and 750 Hz up from the lower skirt for CW transmitting. Frequency adjustments should be kept within ± 20 Hz.

- 1.) Connect the frequency counter to the junction of R6 and R7. R7 is the 150 ohm resistor in the oscillator emitter lead. If there is no dc blocking capacitor in the input of the counter, connect the input through a .01 uF capacitor.
- 2.) Jumper the CWU terminal pin on the SSB assembly to chassis ground.
- 3.) Connect either the VTVM or oscilloscope to the OUTPUT pin terminal on the assembly.
- 4.) Set MODE switch to SB-R position and apply power.
- 5.) Adjust capacitor C1 for a frequency reading of 9,001,500 Hz. This adjustment is a temporary one to place the oscillator in the center of the passband.
- 6.) Peak T1 for maximum reading on the VTVM or 'scope. Reading should be approximately 0.5 to 1 volt, rms.
- 7.) VTVM or 'scope may now be disconnected. Remove CWU jumper.
- 8.) Readjust C1 now for 9,003,500 Hz.
- 9.) Set MODE switch to LOCK position, DRIVE control fully CCW. Adjust C2 for 9,000,600 Hz.
- 10.) Set MODE switch to SB-N position, DRIVE fully CCW. Adjust C3 for 8,999,850 Hz.
- 11.) Repeat steps 8, 9 and 10 in sequence until no further adjustments are necessary. C2 and C3 both determine the 9,999,850 Hz frequency and both affect the C1 setting slightly, so readjustment of all three usually is necessary after any one is changed.
- 12.) Reconnect the VTVM and null the carrier in SB-N position with the CARRIER BALANCE trimpot, R10.

Pin Voltage Readings - (SB-N mode, no signal.)

Pin	Transmit	Receive	Pin	Transmit	Receive
GND	0	0	OUTPUT	0	0
LBS	7	7	MIC VOL	0	0
CW	13	13	MIC VOL	0	0
+8.5	8	8	GND	0	0
T	9*	0	MIC	0	0
+8.5	8	8	RX I.F.	0	0
BFO	5.5	5.5	CWU	5.5	5.5

*In LOCK mode, variable between 1 and 9 V, depending on position of DRIVE control.

Transistor Voltage Readings

Transistor	Collector		Base		Emitter	
	Transmit	Receive	Transmit	Receive	Transmit	Receive
Q1	7.5	7.5	5.5	5.5	5.5	5.5
Q2	0	0	0.8	0.8	0	0
Q3	0	0	0.8	0.8	0	0
Q4	4.5	4.5	1.8	1.8	1.2	1.2
Q5	4.3	4.3	0.7	0.7	0.1	0.1

IC-1	Transmit	Receive
Pin 1	5	5
Pin 2	1.9	0
Pin 3	0	0
Pin 4	1.2	0
Pin 5	5	5
Pin 6	8	8
Pin 7	5.6*	0
Pin 8	8	8



Pins viewed from bottom of circuit board.

*In LOCK position voltage between 0.5 and 5.6 volts, depending on position of DRIVE control.

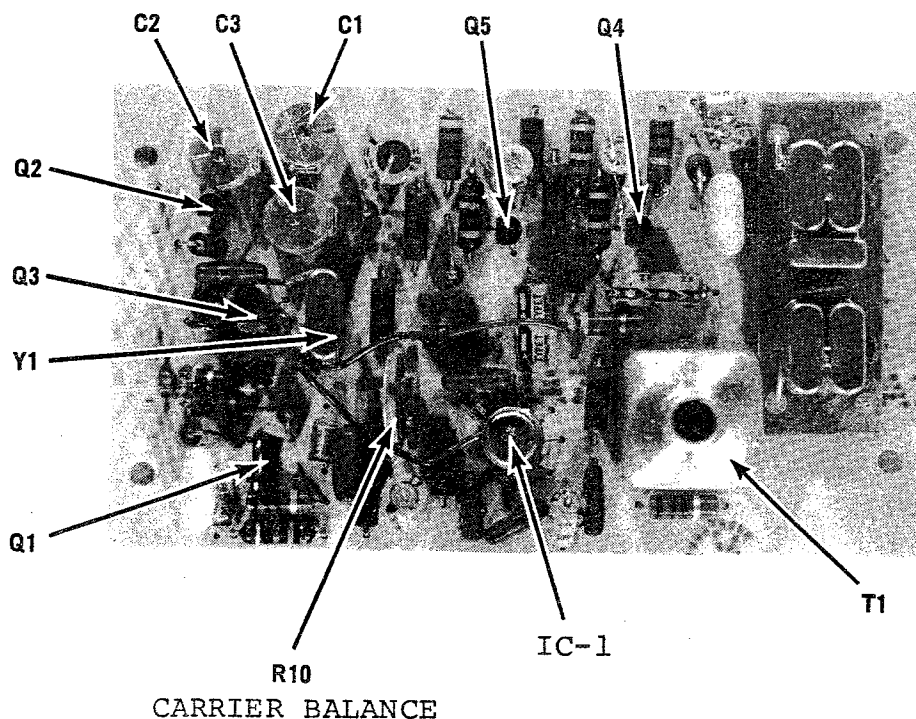
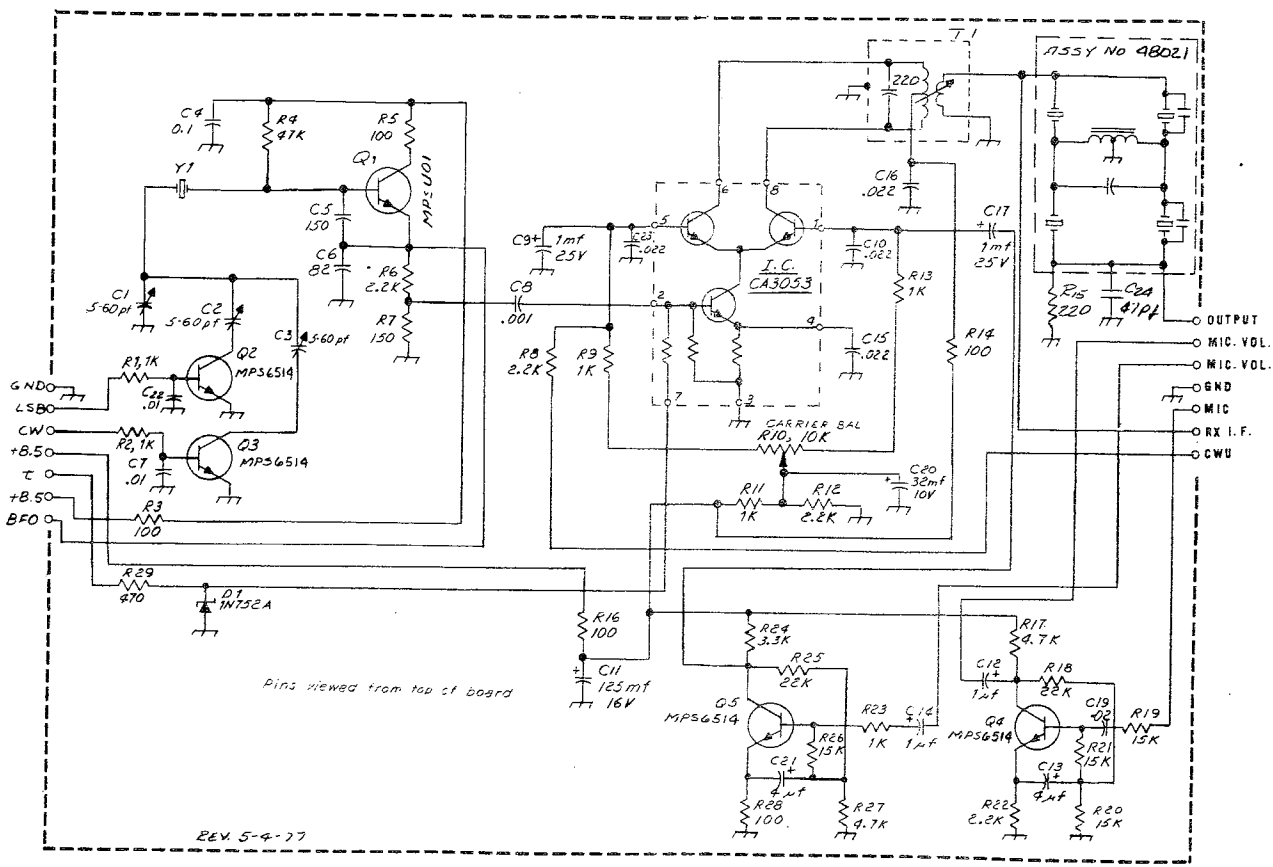

80131 SSB GENERATOR

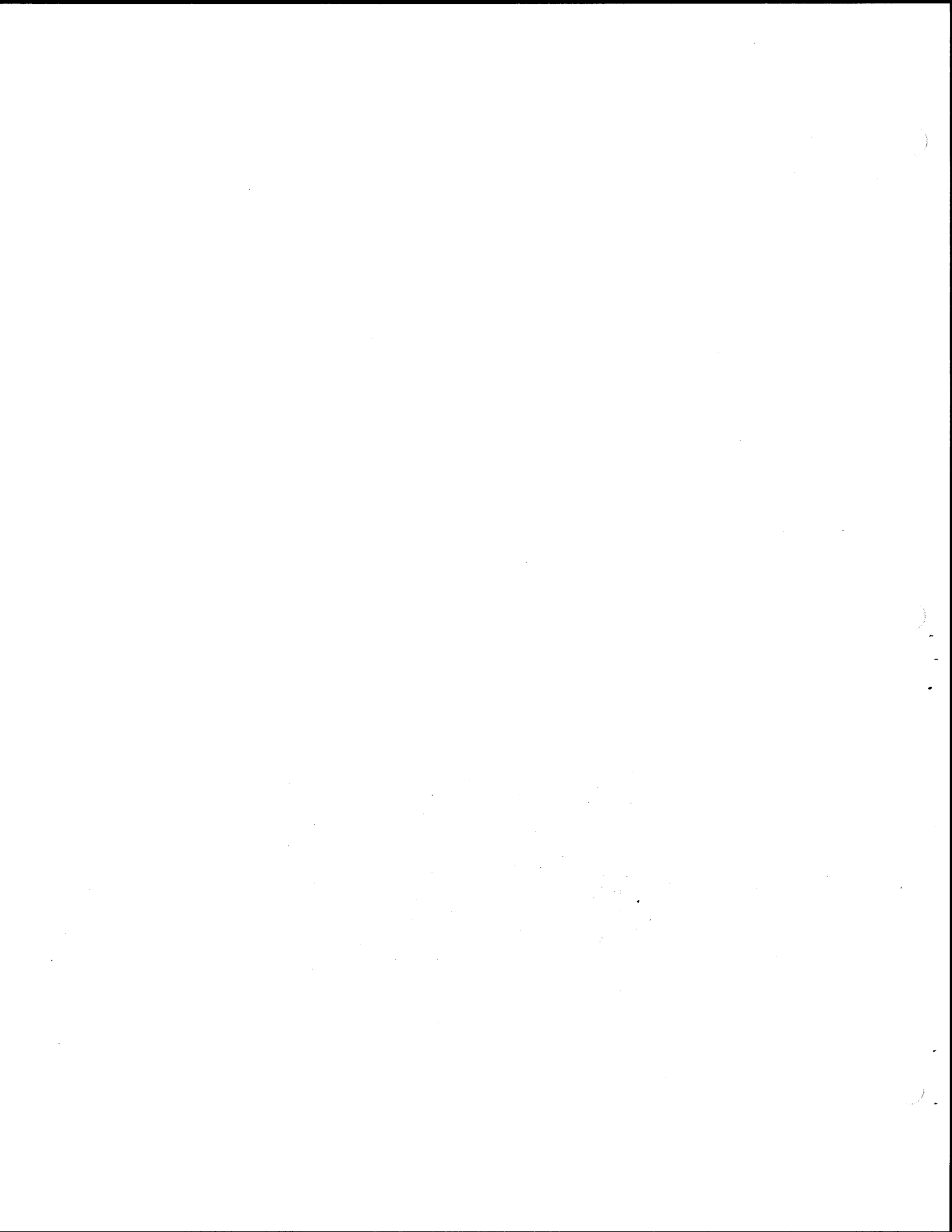

80185 RF POWER AMPLIFIER

The rf power amplifier is a broadband design. It operates over a frequency range from 1.5 MHz to 30 MHz. Transformers T1 and T2 form a broadband impedance matching network to transform the low impedance at the bases of Q1 and Q2 to 50 ohms. The supply voltage may be between 12 and 14 volts. Transformers T5 and T6 transform the output impedance to 50 ohms. The BIAS pin is connected to the "T" terminal on the control board module. Although the output was designed for a 50 ohm load it will work satisfactorily with loads between 30 and 75 ohms. It is quite rugged and will not be damaged by a momentary open or short circuit at the output.

Pin Voltage Readings - (SB-N Mode, DRIVE fully CCW)

Pin	Transmit	Receive
OUTPUT	0	0
GND	0	0
N.C.	13	13
+12	13	13
BIAS	9	0
INPUT	0	0
GND	0	0

Transistor Voltage Readings - (LOCK Mode, DRIVE fully CCW)

Transistor	Collector	Base	Emitter
Q1 & Q2	13	0.7	0

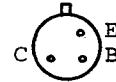

Pins viewed from bottom of circuit board.

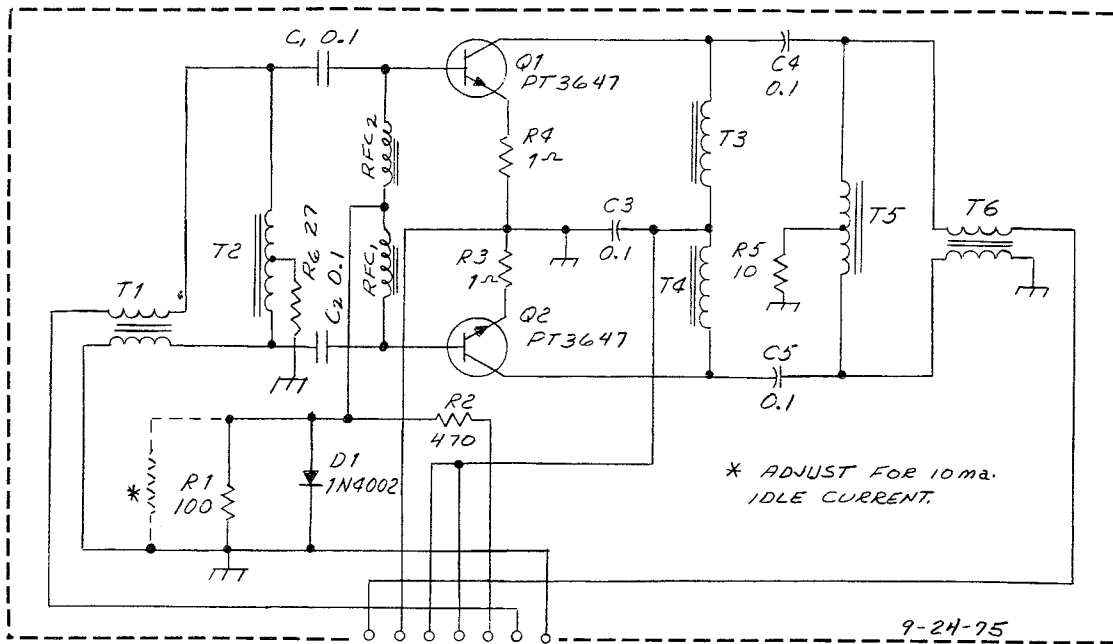

T1&T2-16t Bifilar *28 CF102 Q1 mat'l.
 T3&T4-16t *28 CF102 Q1 mat'l.
 T5&T6-16t *28 Bifilar CF102 Q1 mat'l.
 Pins viewed from top of board

80185 R.F. POWER AMP.

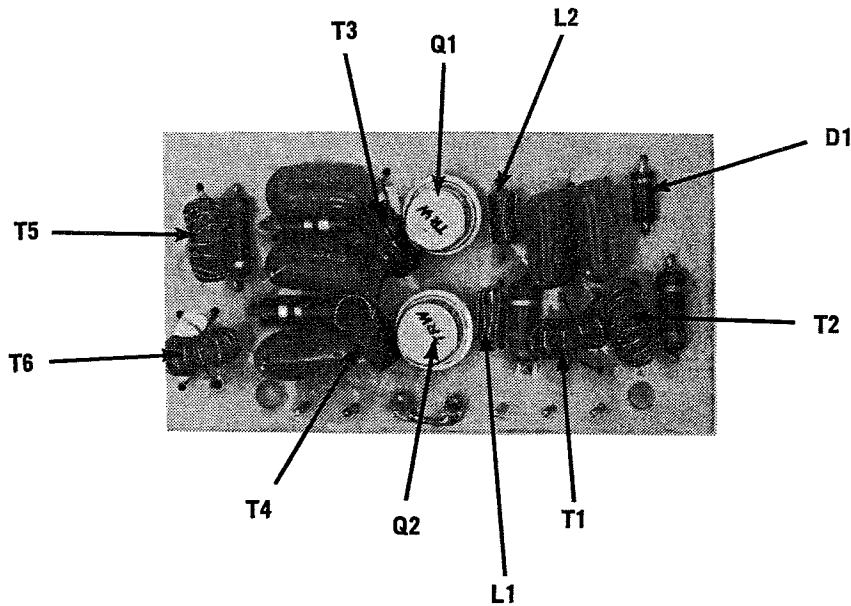

80185 R.F. POWER AMP.

80260 LOW PASS FILTER - SWR BRIDGE

This PC assembly is an integral part of the main chassis and is mounted vertically on the outer back surface of the VFO oscillator sub-chassis. Rf output from the power amplifier is passed through one of four low pass filters as selected by the position of the BAND switch. The 21.0 and 28.0 MHz bands share a common filter. These filters greatly reduce the harmonic content from the raw output of the final amplifier.

Output from the selected filter passes to the antenna jack through T1, whose secondary feeds the SWR bridge circuit. C13 is adjusted for best null when observing REVERSE power on the meter at a frequency of 29.0 MHz, with a 50 ohm resistive dummy load connected to the antenna terminals. (Figure 2)

Since there are no pin terminals nor transistors on this assembly, no voltage measurements are required when servicing the unit.

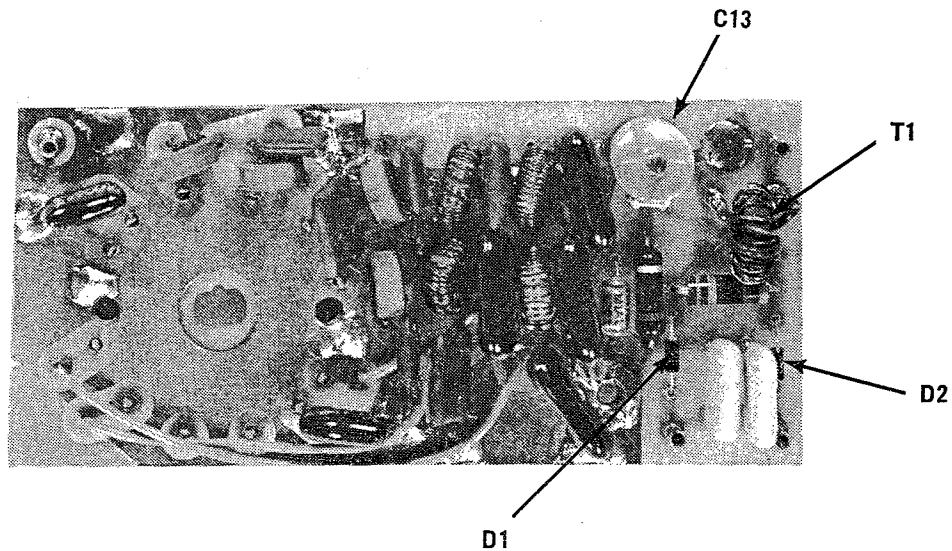
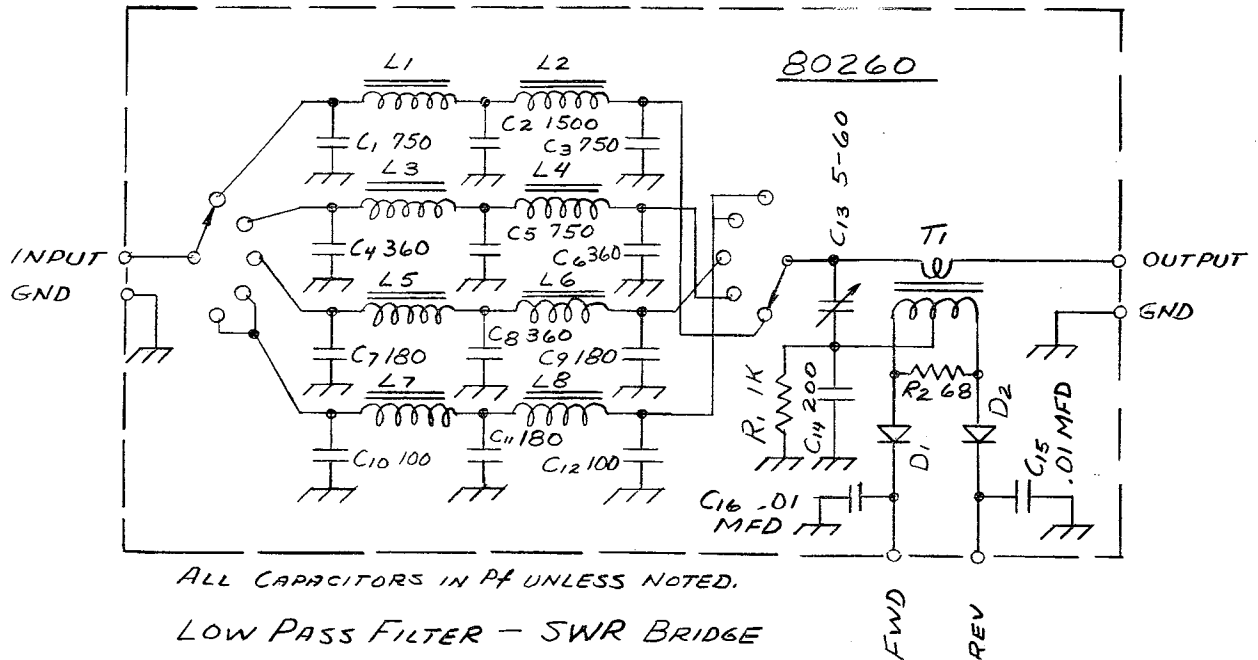

80260 LOW PASS FILTER-SWR BRIDGE

80126 CONTROL BOARD

Transistors Q1, Q2 and Q3 form a complementary switch. The output, connected to pin "T", is normally at ground potential. Transistors Q4, Q5 and Q6 form a similar switch, whose output is connected to pin "R". This output potential is normally at about +10 volts. The "T" voltage is used to bias the transmitting stages to the "on" condition, and the "R" voltage for biasing the receiver stages on. When the T/R pin is grounded, the potentials at "T" and "R" reverse, i.e. "T" goes to +10 volts and "R" to ground.

The receive bias switch, Q4, Q5 and Q6, is also used as an AGC amplifier. The positive AGC voltage, derived from the i-f assembly, is applied to the AGC pin, which controls the value of "R" voltage. As signal strength increases, the "R" value decreases. This circuit is independent of the value of the "T" voltage.

PIN diode, D3, acts as an rf switch in the receiver antenna line, which is controlled by Q8. In the receive mode, "R" voltage applied to the base of Q8 turns it on and effectively places its collector at ground potential. Doing so forward biases D3, since its cathode is tied to the collector through L1 and its anode to +12 volts through R20. L1 and R20 are high impedances to the rf signals so that under this forward biased condition, the ANT terminal is connected to the RCVR terminal through blocking capacitors C4 and C5. When transmitting, Q8 removes the short to ground and D3 becomes reverse biased. Its cathode goes to a high positive voltage through R21 and its anode down to approximately zero, since it is returned to the "R" voltage through R20.

Integrated circuit IC-1 provides a regulated +8 volts which powers the oscillators and other voltage critical circuits.

The S-Meter, a 500 uA movement, is connected between the "R" voltage and the terminal marked S-METER. This terminal presents a dc potential to one meter terminal whose value is determined by the S-METER ZERO potentiometer R11. It is adjusted to the "R" voltage value so that with no signal present, the meter reads zero. As signal increases, the "R" voltage decreases, which causes the meter deflection to increase.

An offset control voltage is developed across non-conducting transistor Q7, with approximately 6 volts appearing at the collector and 3 volts at the emitter. The OFFSET control, located on the front panel, is bridged across these terminals, and the center potentiometer terminal selects a voltage value between the set limits. This voltage is applied to varactor diode D1 in the VFO. The offset control voltage is made to seek the mid-point value between the limits whenever the OFFSET-ON-OFF terminal is connected to a positive voltage, or open circuited. Under these conditions, Q7 is biased "on" through R16 and R17. The emitter and collector voltages become nearly equal, except for a very small saturation voltage, and since R15 and R18 are nearly equal in value, this center voltage will approximate one half of the applied 8 volts. Condition for this to happen, i.e. OFFSET disabled, is in the transmitting mode when "T" voltage is applied to the ON-OFF terminal, or when the knob switch controlling OFFSET ON-OFF is opened. R18 serves to set the center position offset voltage to the same value as the disabled offset voltage. With the OFFSET control set to mid-rotation, adjust R18 so there is no detuning of a received signal when the OFFSET knob is either in or out.

Due to the very small residual saturation voltage of Q7, there will remain a very small frequency shift when the OFFSET is disabled and the control is varied from one extreme to the other. This variation is in the order of 5% of the frequency swing available when OFFSET is working.

Pin Voltages - (Rf gain fully CCW, drive fully CCW, no signal received, CW mode.)
(OFFSET knob in and centered.)

Pin	Transmit	Receive	Pin	Transmit	Receive
T/R	0	10	GND	0	0
R	0.2	9.5	+12	13	13
AGC	0	0.4	+8.5	8	8
T	9	0	OFFSET	4.2	5.3
RCVR	0	0	OFFSET ON-OFF	9	0
ANT	0	0	S-METER	0.5	9.5
GND	0	0	OFFSET	4.1	3

Transistor Voltage Readings

Transistor	Collector		Base		Emitter	
	Transmit	Receive	Transmit	Receive	Transmit	Receive
Q1	12	0	0	0.7	0	0
Q2	0	0	12	0	9	0
Q3	13	13	12	0	11	0.1
Q4	0.7	10.5	0	0.4	0	0
Q5	0	0	0.7	10.5	0.3	9.5
Q6	13	13	0.7	10.5	0.3	9.5
Q7	4.2	5.3	4.5	0.6	4.1	3
Q8	13	0.1	0.1	0.7	0	0

IC-1

Pin	Voltage	Pin	Voltage
1	-	8	-
2	8.2	9	-
3	8.0	10	8.2
4	7.1	11	13
5	7.1	12	13
6	7.1	13	10
7	0	14	-

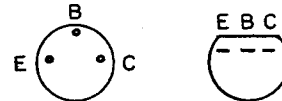

Transistor pins bottom view.

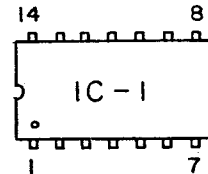

Integrated circuit pins top view.

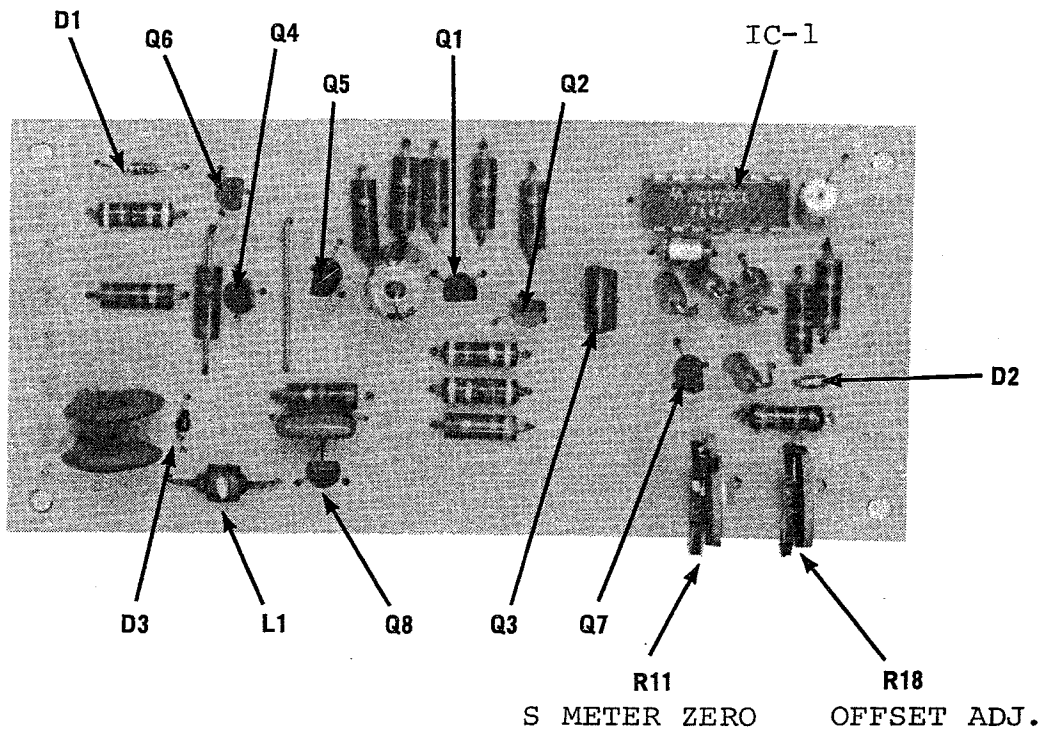
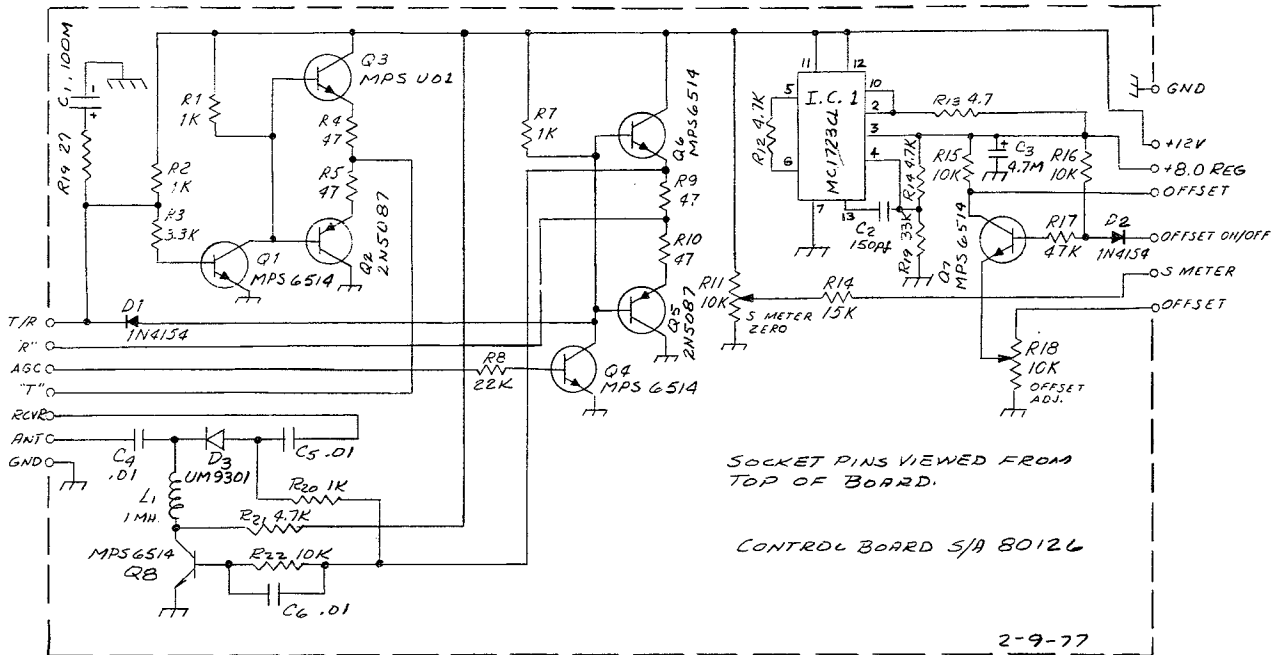

80126 CONTROL BOARD

Ten-Tec, Inc.
1185 Dolly Parton Parkway
Sevierville, TN 37862
Repair Service: (865) 428-0364

LIMITED WARRANTY AND SERVICE POLICY, U.S.A. AND CANADA

Ten-Tec, Inc., warrants this product to be free from defects in material and workmanship for a period of one (1) year from the date of purchase, under these conditions:

1. **THIS WARRANTY APPLIES ONLY TO THE ORIGINAL OWNER.** It is important that the warranty registration card be sent to us promptly.
2. **READ THE MANUAL THOROUGHLY.** This warranty does not cover damage resulting from improper operation. Developing a thorough understanding of this equipment is your responsibility.
3. **IF TROUBLE DEVELOPS** we recommend you contact our customer service group direct at the address or phone number shown above. It has been our experience that factory direct service is expeditious and usually results in less down-time on the equipment. Some overseas dealers do offer warranty service and, of course, have our complete support.
4. **EQUIPMENT RETURNED TO THE FACTORY** must be properly packaged, preferably in the original shipping carton(s). You pay the freight to us and we prepay surface freight back to you. Canadian customers must have proper customs documentation sent with incoming repair equipment. Duties or fees charged due to improper documenting are the responsibility of the owner of the equipment.
5. **EXCLUSIONS.** This warranty does not cover damage resulting from misuse, lightning, excess voltages, polarity errors or damage resulting from modifications not recommended or approved by Ten-Tec. In the event of transportation damage, a claim must be filed with the carrier. Under no circumstances is Ten-Tec liable for consequential damages to persons or property caused by the use of this equipment.
6. **TEN-TEC RESERVES** the right to make design changes without any obligation to modify equipment previously manufactured, or to notify owners of changes to existing equipment.
7. **THIS WARRANTY** is given in lieu of any other warranty, expressed or implied.

SERVICE OUTSIDE OF THE U.S.A. OR CANADA

Many of our international dealers provide warranty service on the equipment they sell. Many of them also provide out of warranty service on all equipment whether they sold it or not. If your dealer does not provide service or is not conveniently located, follow the procedure outlined above. Equipment returned to us will be given the same attention as domestic customers but roundtrip freight expense, customs and broker fees will be paid by you.

Part no. 74244