

SONY

3-861-713-11 (1)

***PLL Synthesized
Scanning Receiver
ICF-SC1/ICF-SC1PC***

Operating Instructions

WARNING

To prevent fire or shock hazard, do not expose the unit to rain or moisture.

To avoid electrical shock, do not open the cabinet.

Refer servicing to qualified personnel only.

Owner's record

The model and serial numbers are located at the bottom of the receiver. Record them in the space provided below. Refer to them whenever you call your Sony dealer regarding this product.

Model No. _____

Serial No. _____

WARNING

You are cautioned that any changes or modifications not expressly approved in this manual could void your authority to operate this equipment.

Use of this scanning receiver in a motorized vehicle may be unlawful or require a permit in certain areas. Contact your local law enforcement authorities for more information.

The Federal Electronic Communications Privacy Act (ECPA), as amended, prescribes intentionally listening to, using, or disclosing the contents of a cellular or cordless telephone transmission as illegal.

This scanning receiver excludes the cellular phone band from its frequency range. Any modification of this receiver to the contrary is likewise illegal by the ECPA.

Information (for ICF-SC1PC)

This equipment has been tested and found to comply with the limits for a Class B digital device, pursuant to Part 15 of the FCC Rules. These limits are designed to provide reasonable protection against harmful interference in a residential installation. This equipment generates, uses, and can radiate radio frequency energy and, if not installed and used in accordance with the instructions, may cause harmful interference to radio communications. However, there is no guarantee that interference will not occur in a particular installation. If this equipment does cause harmful interference to radio or television reception, which can be determined by turning the equipment off and on, the user is encouraged to try to correct the interference by one or more of the following measures:

- Reorient or relocate the receiving antenna.
- Increase the separation between the equipment and receiver.
- Connect the equipment into an outlet on a circuit different from that to which the receiver is connected.
- Consult the dealer or an experienced radio/TV technician for help.

2

Welcome!

Welcome to the world of scanning reception. Here are some of the capabilities and features you will discover with the new PLL Synthesized Scanning Receiver.

- PLL (Phase Locked Loop) synthesized scanning receiver with a frequency range of 25 - 1300 MHz (excluding cellular phone frequencies).
- PC controllable (ICF-SC1PC only) — Connect to a Personal Computer for total control of your scanning receiver using the PC control software. The CD-ROM frequency database (supplied) provides information for station frequencies nationwide.
- Easy access to the PSBs (Public Service Bands) with Service Scanning — Receive any one of the 9 pre-programmed PSBs (AIR[VHF], AIR[UHF], Weather, Police, Fire/Emergency, Marine, FM broadcast, TV[VHF sound], and TV[UHF sound]) with just a touch of a button.
- Variety of scanning options — Band Scanning, Programmable Scanning, Memory Scanning, and Intelligent Memory Scanning.
- 300 channel memory — Store the stations of your choice (10 pages, 30 channels per page). The EEPROM retains stored information without backup batteries.
- Priority Scanning function — Checks every 5 seconds if there is reception in a priority frequency you have designated.
- Direct manual tuning — Simply input the digits of the frequency from the numeric keypad if you know the frequency.
- SKIP function — Skips the frequencies you have designated during scan (up to 100).
- Adjustable scanning pause time — Normal, 2 second-delay mode, and the 5 second-pause mode.
- Adjustable frequency steps.
- Supports AM, NFM, WFM detection modes in all frequencies.
- Backlighted Liquid Crystal Display.
- Key protection to avoid operation by inadvertent key strokes.

3

Table of contents

Preparation	
Power sources	5
Using the receiver on batteries	5
Using the receiver on AC power	6
Using the receiver on a car battery	6
Attaching/detaching the antenna	7
Attaching/detaching the belt holder	7
Using the earphone	8
Reception	
Various ways of reception	9
Receiving in the Scanning Mode	
Band Scanning	10
Frequency range of the bands	10
Adjusting the SQL control	11
Memory Scanning	13
Programmable Scanning	15
Defining the frequency range	15
Running Programmable Scanning	16
Service Scanning	17
Intelligent Memory Scanning	19
Receiving in the Manual Mode	
Direct Tuning	20
Manual Tuning	21
Preset Tuning	22
Presetting stations in the memory	22
Recalling a preset channel	23
Erasing preset memory	25
Priority Scanning	
Priority Scanning	26
Specifying the priority frequency	26
Running Priority Scanning	26
Other useful functions	
SKIP function	28
Designating a SKIP-frequency	28
Adjusting scanning pause time	30
DELAY	30
Limiting scanning pause to 5 seconds (5-second pause mode)	30
Adjusting frequency step and detection mode	31
Adjusting the frequency step	31
Adjusting the detection mode	31
Key protection	32
Turning on the light	32
Turning off the beep	32
Additional information	
Troubleshooting	33
Precautions	35
Specifications	36
Supplied accessories	36
Optional accessories	36
Location and function of controls	37
Front	37
Side/rear	38
Display	39

►Preparation

Power sources

Using the receiver on batteries

Inserting the batteries

Insert four size AA (R6) batteries with correct polarity as shown in the illustration.

Wait at least 3 seconds before turning on the power on the receiver.

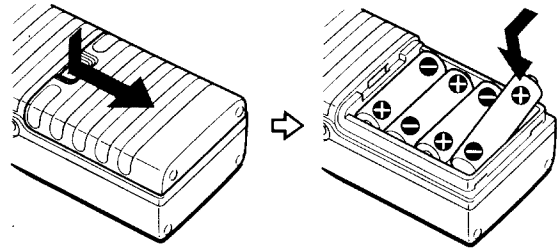



For longer battery life, we recommend the use of alkaline batteries.

Note

- When using the receiver on batteries, unplug the AC power adaptor or the car battery cord from the DC IN 6 V jack on the receiver, if plugged in.

When to replace the batteries

When the batteries become weak, the sound becomes weak and distorted.  will flash in the display. When the batteries become exhausted,  will light up and the power will go off.

Replace all four batteries with new ones when  starts to flash.

Notes

- Turn off the power when replacing the batteries.
- After removing the old batteries, install the new ones within 20 seconds. Otherwise, the present status (the current reception mode) of the receiver will be lost and will return to the factory preset. The frequencies stored in the preset memory are unaffected.
-  will disappear from the display when you turn on the power with the new batteries.
- When running the receiver on AC power or when you are not using the receiver for an extended period of time, remove the batteries to avoid battery discharge and damage to the receiver from battery leakage.

Battery life

10 hours using four LR6 Sony alkaline batteries (with the squelch open continuously for 4 hours a day).

Using the receiver on AC power

Plug in the supplied AC power adaptor in to the DC IN 6V jack.

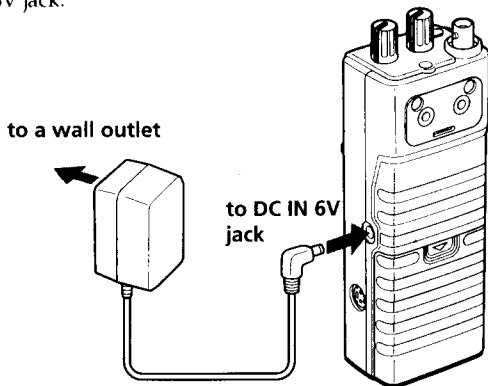

Notes

- Do not twist or crumple the AC power adaptor cord forcefully. Do not place any heavy object on the cord.
- To disconnect the AC power cord, pull it out by the plug, not the cord.
- When you are not using the receiver for an extended period of time, disconnect the AC power adaptor both from the wall outlet and the receiver.

Using the receiver on a car battery

Plug in the car battery cord (not supplied) to the DC IN 6V jack.

For more information, consult the Operating Instructions for the car battery cord.

Notes

- Turn off the power when plugging or unplugging the AC power adaptor or the car battery cord from the DC IN 6 V jack. Otherwise, the power may be cut off and  may appear in the display. In this case, press POWER to turn the power on again. The display will disappear.
- When using the receiver on batteries, unplug the AC power adaptor or the car battery cord from the DC IN 6 V jack on the receiver. The receiver will not be powered by the batteries as long as the DC IN 6V jack is plugged in. If you plug in the AC power adaptor or the car battery cord to the DC IN 6 V jack, the power will automatically switch to external power even if the batteries are installed.
- Use only the supplied/recommended AC power adaptor and car battery cord.



Polarity of the plug

- The display will be lit with the backlight when you are using the AC power adaptor or the car battery cord (see "Turning on the light", page 32).

Attaching/detaching the antenna

Fit the supplied helical antenna so that the projection on the connector of the main unit fits the slot on the antenna. Hold the antenna by the connector and turn it clockwise until the connector clicks.

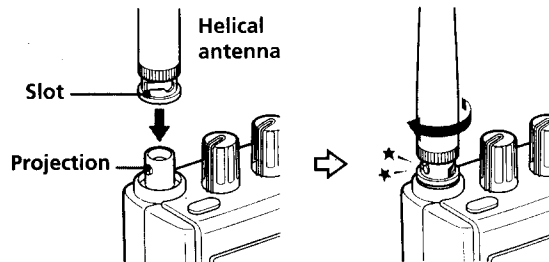

To detach the antenna

Turn the antenna counterclockwise to release the lock of the connector.

Note

When detaching the antenna, hold the antenna by the connector. Do not hold the antenna rod itself.

Attaching/detaching the belt holder

Place the holder so that the projection on the holder fits the slot on the main unit. Turn the screws clockwise with a coin.

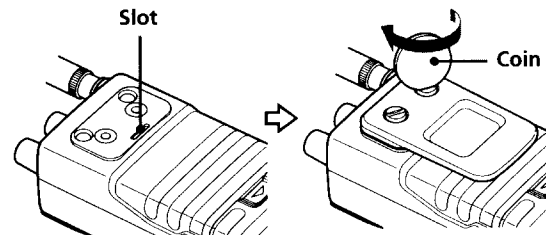

To detach the belt holder

Turn the screws counterclockwise.

Using the earphone

To listen through the earphone, plug in the earphone to the  jack as shown in the illustration.

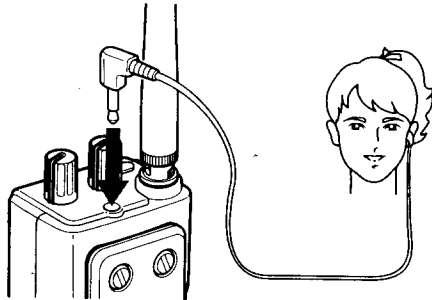

NOTICE

Be sure to adjust VOL (volume) to a moderate level before turning on the power or plugging in the earphone. There will be no sound when there is no reception (squench closed). Sudden reception (opening of the squench) may cause unexpected loud sound and may cause hearing damage.

►Reception

Various ways of reception

The scanning receiver offers a variety of scanning and tuning options. Refer to the pages in the parenthesis for details.

Scanning Mode

Band Scanning (page 10)

scans one of the predefined frequency bands

Memory Scanning (page 13)

scans the frequencies you have preset in the memory

Programmable Scanning (page 15)

scans a frequency range that you have defined

Service Scanning (page 17)

scans one of the 9 pre-programmed Public Service Bands of your choice

Intelligent Memory Scanning (page 19)

scans the 10 recent reception frequencies (memorized automatically)

Manual Mode

Direct Tuning (page 20)

tune in by inputting the frequency digits

Manual Tuning (page 21)

tune in by adjusting the frequency step by step with the +/- keys

Preset Tuning (page 22)

tune in by recalling a frequency you have preset in the memory

Priority Scanning (page 26)

checks every 5 seconds if there is reception in a priority frequency (works in either modes)

Receiving in the Scanning Mode

Band Scanning

The receiver divides its frequency range (25.0 MHz to 1300.0 MHz) into 17 bands. Band Scanning scans one of these bands step by step.

- 1 Set the SQL control to MIN.
- 2 Press POWER to turn the receiver on.
- 3 Turn VOL to adjust the volume.
- 4 Press BAND repeatedly to choose a band. With each press, the lowest frequency of the next band will be displayed. Press repeatedly until the display shows the lowest frequency of the band of your choice.

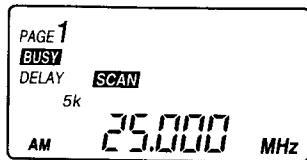

- 5 Adjust the SQL control (see page 11). Scanning will start. When the receiver receives a signal, **BUSY** will light up and the receiver will go into scanning pause. When the signal breaks off, the receiver will resume scanning automatically.

To turn off the power
Press POWER.

Frequency range of the bands

Frequency range (MHz)	Step	Detection Mode
25.0 ~ 29.0	5kHz	AM
29.0 ~ 54.0	5kHz	NFM
54.0 ~ 72.0	50kHz	WFM
72.0 ~ 76.0	5kHz	NFM
76.0 ~ 88.0	50kHz	WFM
88.0 ~ 108.0	100kHz	WFM
108.0 ~ 137.0	12.5kHz	AM
137.0 ~ 148.0	5kHz	NFM
148.0 ~ 174.0	5kHz	NFM
174.0 ~ 216.0	50kHz	WFM
216.0 ~ 225.0	5kHz	NFM
225.0 ~ 400.0	12.5kHz	AM
400.0 ~ 470.0	12.5kHz	NFM
470.0 ~ 512.0	12.5kHz	NFM
512.0 ~ 806.0	50kHz	WFM
806.0 ~ 1000.0	12.5kHz	NFM
(excluding cellular phone band)		
1000.0 ~ 1300.0	12.5kHz	NFM

(AM: Amplitude Modulation. NFM: Narrow Band Frequency Modulation. WFM: Wide Band Frequency Modulation)

Note

The frequency steps and the detection modes in the list are the default for each band. You can adjust the frequency step and the detection mode when you are in Manual Mode. You cannot adjust them when you are in Scanning Mode.

To resume scanning manually during scanning pause

Press + or -.

To change scanning direction

Press + or -.

Scanning will restart in ascending direction if you press +, and in descending direction if you press -.

Note

When you start scanning a new band, scanning will always start in ascending direction.

To exit Scanning Mode

Press SCAN.

SCAN will disappear from the display and the receiver enters the Manual Mode. Press again to re-enter the Scanning Mode.

If you press SCAN for 1 second or longer, the scanning pause time will go into the 5-second pause mode (see page 30).

Adjusting the SQL control

Adjustment of the SQL control applies to all modes of reception.

What the SQL control does

The SQL (squelch) control adjusts the threshold of the signal intensity that opens the squelch.

When the receiver receives a signal above the threshold, the squelch will open, **BUSY** will appear in the display, and you will hear the transmission sound.

When the squelch opens during scanning, the receiver stops scanning. This is called a "scanning pause".

As you turn the SQL control counterclockwise to MIN, the receiver will pause scanning on weaker signals. But this may cause the receiver to pause scanning on unwanted noise signals.

As you turn the SQL control clockwise to MAX, the receiver will cut off the weaker signals and receive only stronger signals. If it is turned too far clockwise, on the other hand, there may be no signal strong enough to cause a scanning pause.

Adjusting the SQL control

Start from the MIN position and turn it clockwise towards MAX to the point the **BUSY** indication disappears in the display.



When there is a signal above the squelch threshold, **BUSY** will light up and the receiver pauses scanning. Scanning will resume automatically when the signal breaks off.

NOTICE

If you wish to listen to transmission continuously (such as when listening to FM broadcast, TV sound, or Weather broadcast, etc.), be sure to set SQL to MIN so that the squelch does not close when the signal gets weak.

Memory Scanning

Memory Scanning scans the frequencies you have preset in the memory. (To preset a station in the memory, see page 22). Choose one or more target pages to run Memory Scanning.

- 1 Set the SQL control to MIN.
- 2 Press POWER to turn the receiver on.
- 3 Recall any preset channel (see "Recalling a preset channel", page 23).
The preset number will appear in the display.

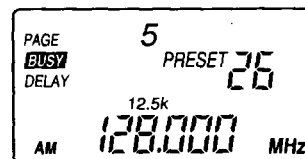

- 4 Press SCAN.
The receiver will enter the Memory Scanning mode.
The page number(s) for the target page(s) will appear in the display.

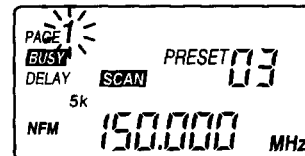

Here, the receiver is scanning page 1.

- 5 Adjust the SQL control (see page 11).
- 6 Select the target page.
With each press of the number key, the page number will appear and disappear alternately in the display.

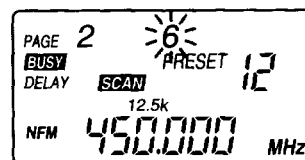

Here, you have pressed 2 and 6 (to add these pages), and 1 (to discard the page). The receiver is currently pausing scanning on preset channel number 12 of page 6.

Notes

- The number for the current target page will flash in the display.
- When there is only one page in the display, you cannot discard the page from the scanning target.

- When the current target page has no occupied channel (i.e., the page has no channel with a preset frequency), the display will be as follows.

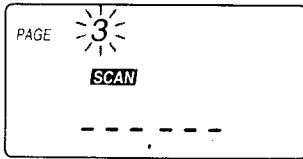

In this case, first add a valid target page if this is the only target page, then, discard this page from the target page.

- If all the preset channels in a current target page are SKIP-designated frequencies, the display will be as follows.

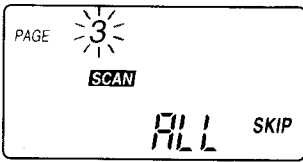

In this case, first add a valid page to the scanning target page if this is the only target page, then, discard this page.

To change scanning direction

Press + or - .

To resume scanning manually during scanning pause

Press + or - .

Programmable Scanning

Programmable Scanning scans a frequency range you have defined step by step. You can also specify the frequency step and the detection mode.

Defining the frequency range

Define the range by specifying the lower and the upper limits of the range. The preset channels for the upper and lower limits are located after channel 30 of page 10. You cannot use any other channel for this purpose.

- 1 Set the SQL control to MIN.
- 2 Press POWER to turn the receiver on.
- 3 Tune in, by any way, to a frequency to be specified as the lower limit of the range.
- 4 Adjust the frequency step and the detection mode. Press STEP repeatedly to select a frequency step of your choice. Press MODE repeatedly to select a detection mode of your choice (see "Adjusting frequency step and detection mode", page 31). Skip this step to select the default step and detection mode.
- 5 While holding down ENTER, press "10/0", then EXE. "PRESET" and the preset number will flash in the display. (Do not release ENTER).
- 6 While holding down ENTER, press + or - repeatedly until "PRESET L" appears for the preset number display. With each press, the preset number display will change as follows.

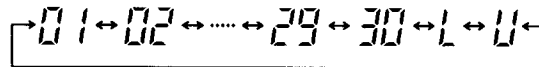

"L" ("Lower limit") comes after preset channel 30. (Do not release ENTER).

- 7 While holding down ENTER, press EXE again. The lower limit frequency has been memorized in preset L.
- 8 Repeat steps 3 to 7 to memorize the upper limit frequency in preset U. "U" ("Upper limit") comes after preset L. Select the same frequency step and detection mode as you did for the lower limit frequency.

Notes

- You can specify either frequency first
- If you have selected a different frequency step or detection mode for the upper and lower limits, the one(s) memorized later will take precedence.
- The delay setting is not saved for preset channel L or U.

Running Programmable Scanning

- 1 Hold down ENTER and press SCAN lightly (i.e., less than 1 second).
Scanning will start from the lower limit frequency.
- 2 Adjust the SQL control (see page 11).



Once you have defined a scanning range, you do not need to define it again as long as you are scanning the same frequency range.

Notes

- Do not press SCAN for 1 second or longer while holding down ENTER. If you do, the receiver will enter the 5-second pause mode and the decimal point will flash in the display. See "Adjusting scanning pause time", (page 30).
- If you try to run Programmable Scanning with an invalid range definition (i.e., the specified upper and lower limits are the same frequency, or, either or both limits have not been specified), the receiver will display the memory content of the two frequencies and then return to the previous status.
- During Programmable Scanning, the receiver will start scanning from the lower of the two specified frequencies. Thus, if, for example, the frequency memorized under PRESET L is higher than the frequency memorized for PRESET U, scanning will start from the frequency in PRESET U.
- Although the upper and lower limit frequencies are located after channel 30 in page 10, they do not belong to this page; they will not be scanned when page 10 is targeted in Memory Scanning.

To display the current scanning range

Press PAGE, then "10/0", then EXE. Page 10 will appear in the display.
Press PRESET, then + or - repeatedly until "PRESET L" or "PRESET U" appears for the preset number display.

To change scanning direction

Press + or -.

To resume scanning manually during scanning pause

Press + or -.

Note

When presetting or recalling a frequency in preset L or U, you can also recall these channels by pressing "31" (for preset L) or "32" (for preset "U") and then EXE.

Service Scanning

Service Scanning scans one of the 9 pre-programmed Public Service Bands of your choice. A button is assigned to each of the bands for instant access.

Pre-programmed Public Service Bands

Service Band	Key number
WX (NOAA WEATHER broadcast)	1
POLICE	2
FIRE/FMG (Fire and emergency)	3
MARINE	4
AIR(V) (Aircraft[VHF])	5
AIR(U) (Aircraft[UHF])	6
FM broadcast	7
TV(V) (TV sound[VHF])	8
TV(U) (TV sound[UHF])	9

- 1 Set the SQL control to MIN.
- 2 Press POWER to turn the receiver on.
- 3 Press SVC.
The receiver will enter the Service Scanning mode.
"SVC SCAN" will flash in the display.

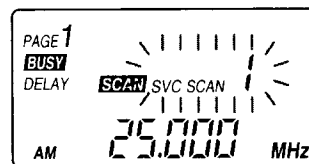

- 4 Press the number key for the Public Service Band of your choice.
2 (POLICE band) is shown here as an example.

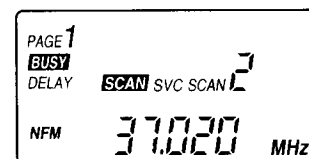

- 5 Adjust the SQL control (see page 11).

To exit Service Scanning

Press SVC when the "SVC SCAN" indication is flashing in the display. The receiver will return to the previous status.

Notes

- If you skipped step 4 (pressed EXE when the "SVC SCAN" indication is flashing in the display), scanning will start on the Service Band number displayed at that point.
- If the "SVC SCAN" indication is left flashing for about 5 seconds, scanning will start on the Service Band number displayed at that point.

- When the receiver pauses scanning at a NOAA WEATHER broadcast channel, it will not resume scanning automatically, since all NOAA WEATHER channels transmit continuously. To resume scanning manually, press + or -.
- The NOAA WEATHER broadcast may be difficult to receive in some areas. Try listening in a higher location.
- To run Service Scanning in the 5-second pause mode, press SCAN for 1 second or longer in any other scanning mode (such as Band Scanning) to enter the 5-second pause mode, and then start Service Scanning.

To change scanning direction

Press + or -.

To resume scanning manually during scanning pause

Press + or -.

Intelligent Memory Scanning

When the receiver receives a station continuously for 5 seconds or longer, the frequency is memorized automatically in the Intelligent Memory. The Intelligent Memory holds the 10 most recently received frequencies. Intelligent Memory Scanning scans the frequencies in the Intelligent Memory.

- 1 Set the SQL control to MIN.
- 2 Press POWER to turn the receiver on.
- 3 In the Scanning Mode, press INTE (Intelligent Memory).
In the Manual Mode, press INTE, then press SCAN.



"INTE" will appear in the display and the receiver starts Intelligent Memory Scanning. Here the receiver is pausing scanning on channel 1 of the Intelligent Memory.

- 4 Adjust the SQL control (see page 11).

To recall the frequencies in the Intelligent Memory one by one

Press INTE while Intelligent Memory Scanning is pausing scanning, or in Manual Mode.

With each press, the Intelligent Memory channels will be recalled in ascending order.

Notes

- Intelligent Memory always holds the 10 most recently received frequencies. Thus, the older ones will be erased one by one as there is a new reception. Store the frequency in the Preset memory if it needs to be stored (see page 22).
- If the receiver receives a frequency that is already in the Intelligent Memory, this will not create a second memory entry of the same frequency but will only change the order.
- The INTE indication will disappear if you tune manually by pressing + or - when the Intelligent Memory is recalled.
- You cannot change the detection mode or frequency step when the Intelligent Memory is recalled.
- The delay setting is not saved for the Intelligent Memory. If the DELAY indication is present when running Intelligent Memory Scanning; DELAY is effective for all Intelligent Memory frequencies.
- If you try to run Intelligent Memory Scanning with all the Intelligent Memory frequencies designated a SKIP frequency, "ALL SKIP" will appear in the display and the receiver will return to the previous condition.

To change scanning direction

Press + or -.

To resume scanning manually during scanning pause

Press + or -.

Receiving in the Manual Mode

Direct Tuning

If you know the frequency of a station, tune in directly by inputting the frequency digits on the number keys.

- 1 Set the SQL control to MIN.
- 2 Press POWER to turn the receiver on.
- 3 If you are in the Scanning Mode, press SCAN to enter the Manual Mode.
SCAN will disappear from the display.
- 4 Tune in by pressing the number keys for the frequency digits.
- 5 Press EXE.

Example: to tune in directly to 128.6375 MHz
Press ①→②→⑧→"."→⑥→③→⑦→⑤→EXE

To cancel Direct Tuning input

Press ERASE before pressing EXE.

Notes

- The frequency steps and detection modes will be set to default (see "Frequency range of the bands", page 10). To change the frequency step or detection mode, press STEP or MODE after you have tuned in a frequency (see "Adjusting frequency step and detection mode", page 31).
- If the frequency you have input is not a step frequency, the frequency will automatically change to a step frequency.
- If you tune in directly (i.e., input frequency digits and press EXE) in the Scanning Mode, the receiver will go into the Manual Mode. However, this is not the case during Memory Scanning; pressing the number keys will add/delete scanning target pages.
- If the frequency is a round figure above the decimal point, you do not need to input the digits below the decimal point.
Example: to tune in directly to 128.000 MHz
Press ①→②→⑧→EXE
- If you take more than 10 seconds between key input, Direct Tuning will be cancelled and the receiver returns to the previous condition.

Note on band border frequencies in Direct Tuning or Manual Tuning

The highest frequency of a band is the same as the lowest frequency of the next band (except for that of the highest band). For these frequencies, the default frequency steps and detection modes are set as the lowest frequencies of the next band.

Manual Tuning

Tune in by adjusting the frequency step by step with the +/- keys.

- 1 Set the SQL control to MIN.
- 2 Press POWER to turn the receiver on.
- 3 If you are in the Scanning Mode, press SCAN to enter the Manual Mode.
SCAN will disappear from the display.
- 4 Tune in by pressing the +/- keys.
The + key will move the frequency up and the - key will move the frequency down. One press will move the frequency one step. Hold down the key to move up or down continuously.

Note

- The changes you have made in frequency step or detection mode are effective only in the current band. When you have entered a different band while pressing the +/- keys, the frequency step and detection mode will return to the default for that band (see "Frequency range of the bands", page 10).
- If you press + at 1300 MHz, the frequency display will change to 25 MHz. If you press - at 25 MHz, the frequency display will change to 1300 MHz.

Preset Tuning

The receiver has 10 preset pages, each with 30 channels; thus the receiver can memorize a total of 300 frequencies.

Presetting stations in the memory

When you preset a frequency to a channel, the frequency step, detection mode and the DELAY setting for each frequency is memorized as well.

- 1 Press POWER to turn the receiver on.
- 2 Tune in to the frequency you wish to preset.
- 3 If you are in the Scanning Mode, turn SQL to MIN to pause scanning, or press SCAN to enter the Manual Mode.
You cannot preset a station when the receiver is scanning.
- 4 Preset the frequency to the preset channel of your choice.
While holding down ENTER, press the number key for the page of your choice, then EXE, then the number key for the preset channel number of your choice, then EXE. Do not release ENTER until you have completed presetting.

Example: presetting 128.000 MHz to preset channel 26 of page 5.

Hold down ENTER...

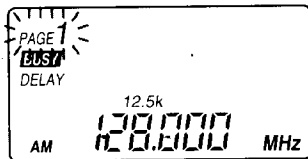

The current page number will flash in the display.

...press 5, then EXE (without releasing ENTER) ...

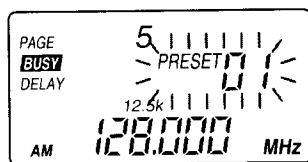

Page 5 has been entered and the preset channel number will flash in the display.

...then press 2, then 6 (without releasing ENTER)...

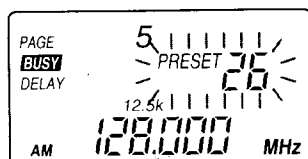

"PRESET 26" will flash in the display.

...then press EXE (without releasing ENTER).



Channel 26 has been entered and presetting is complete. The display returns to the reception display.

To cancel presetting input

Release ENTER.



- To change the page number and channel number input, you can also use the +/- keys when the number is flashing in the display (i.e.: while holding down ENTER).
- If the page number flashing in the display is already the one of your choice when you hold down ENTER, you do not need to press the page number again; press EXE to enter.
- After the page number has been entered, the receiver will first display the number of the lowest unoccupied channel. Therefore, when you are presetting stations the first time around on a particular page, the receiver will automatically start from channel number 1 and move up in order every time you preset a station, without having to input the channel number manually.

Notes

- The "10/0" key functions as 10 for the page number, but as 0 for anything else. To input page number 10, press the "10/0" key. To input channel number 10, press "1" and then "10/0".
- If there is no unoccupied preset channel on the page you have chosen, "PRESET --" will flash in the display.
- If you preset a frequency on a channel that already has a preset frequency, the older frequency will be overwritten by the new one.
- When you preset a frequency, the DELAY setting (see "Adjusting scanning pause time", page 30) for the particular frequency is memorized as well.
To change the DELAY setting for a preset frequency, first recall the preset frequency (see "Recalling a preset channel" below), then press PRI/DELAY for one second or longer. The new DELAY setting will be memorized along with the preset frequency (DELAY will turn on if it had been off, vice versa).
- You cannot preset a station you have received with Memory Scanning, whether or not the receiver is in scanning pause.
- You cannot preset a priority channel frequency you have received with Priority Scanning.

Recalling a preset channel

- 1 Press POWER to turn the receiver on.
- 2 If you are in the Scanning Mode, press SCAN to enter the Manual Mode.
SCAN will disappear from the display.
- 3 Press PAGE, then the number key for the page number you wish to recall, then EXE.
- 4 Press PRESET, then the number key for the preset channel number you wish to recall, then EXE.

Example: recalling preset channel 26 on page 5.
Press PAGE.

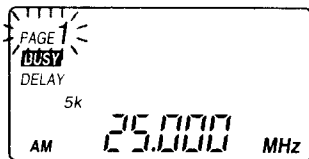

The page number will flash in the display.

Press 5, then EXE.

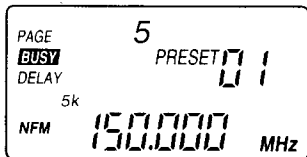

The page number has been entered. "PAGE" and "5" will stop flashing in the display. A preset channel will appear in the display (in this case, 1).

Press PRESET.

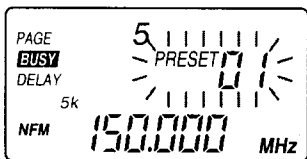

The preset number will flash in the display.

Press 2, then 6, then EXE.

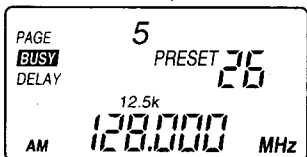

The preset number has been entered. The preset number will stop flashing.

If you press PAGE again while the PAGE indication is flashing in the display, or press PRESET again while the PRESET indication is flashing in the display, the receiver will return to previous status.

To recall a preset channel in the same page

Repeat step 4. You do not have to choose the page again.



To change the page number and channel number input, you can also use the +/- keys when the number is flashing in the display.

Notes

- If you recall a page or a preset channel when you are in the Scanning Mode, the receiver goes into the Manual Mode and the **SCAN** indication will disappear.
- If a page number or a preset channel number is left flashing for 5 seconds or longer, the number will be entered (without having to press EXE).
- If you change the frequency by tuning manually (i.e. by pressing +/-) after you have recalled a station, or if you change the frequency step or the detection mode of the frequency, the preset number indication will disappear in the display.
- If you recall an unoccupied channel, "-----" will appear for the frequency display and the sound will go out.
- If you recall a page with no occupied channels, "-----" will appear for the frequency display momentarily, and then the receiver will return to previous status.

Erasing preset memory

To erase a channel preset

- 1 Recall the preset channel you want to erase.
- 2 Press ERASE until the frequency display changes to "-----".

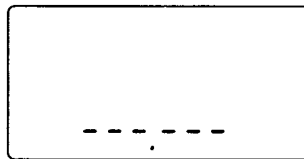

The channel preset has been erased and the display returns to Manual Tuning (without the preset number).

Notes

- You cannot erase a channel preset in the Scanning Mode.
- You cannot erase the priority channel preset while receiving a priority channel with Priority Scanning.
- You cannot retrieve a preset memory you have erased. Make sure of the channel you are erasing.

To erase all preset memory at once

- 1 Press EXE, -, and PRESET simultaneously. "dEL ALL PRESET" will flash in the display.

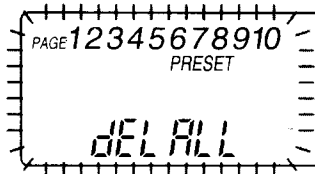

Hold the buttons down for 3 seconds or longer. The flashing will stop and all the preset memory will be erased.

Notes

- You cannot retrieve preset memory you have erased. Make sure of the channels you are erasing.
- This operation will also revert the Intelligent Memory contents to the factory preset.

Priority Scanning

Priority Scanning

Specify a priority frequency of your choice to the priority channel. With Priority Scanning, the receiver checks the priority channel every 5 seconds and switches to this channel if there is reception. If reception is broken, the receiver will return to previous status.

You can run Priority Scanning during any scanning or tuning modes.

Specifying the priority frequency

The priority channel is preset channel 30 on page 10. You cannot use any other channel for this purpose.

- 1 Set the SQL control to MIN.
- 2 Press POWER to turn the receiver on.
- 3 Tune in, by any way, to a frequency you wish to specify as the priority frequency.
- 4 Select the detection mode and the DELAY setting of your choice.
Press MODE repeatedly to select a detection mode of your choice (see "Adjusting frequency step and detection mode", page 31).
Press PRI/DELAY for 1 second or longer to select the DELAY setting of your choice (see "Adjusting scanning pause time", page 30).
Skip this step to select the default detection mode and DELAY setting.
- 5 Preset the frequency to preset channel 30 ("Priority channel") on page 10 (see "Presetting stations in the memory", page 22).

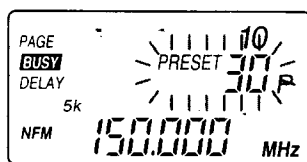

Running Priority Scanning

- 1 Press PRI/DELAY lightly (i.e., less than a second). "PRI" will appear in the display and the Priority Scanning is in effect.
The receiver will check the priority channel every 5 seconds and switches to this channel if there is reception.
- 2 Adjust the SQL control (see page 11).

To cancel Priority Scanning

Press PRI/DELAY lightly (i.e., less than a second) again.

Notes

- You can run Priority Scanning during any scanning or tuning modes.

- All tuning key operation becomes ineffective when receiving the priority channel with Priority Scanning (except for that using + or -). To switch to other scanning or tuning modes, exit Priority Scanning first by pressing PRI/DELAY.
- Though the frequency step setting is memorized for the priority channel, it has no effect on Priority Scanning.
- If you try to run Priority Scanning with no priority frequency (i.e., there is no frequency preset for the priority channel, preset channel 30 on page 10), the following will be displayed momentarily, and then the receiver will return to previous status.

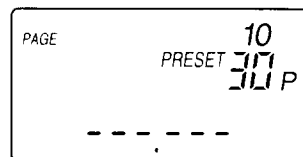

- If you try to run Priority Scanning with the priority frequency designated as a SKIP frequency, the following will be displayed momentarily, and then the receiver will return to previous status.

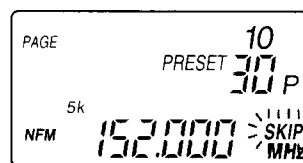

- You cannot assign the priority frequency to any other channel than channel 30 on page 10.

► Other useful functions

SKIP function

You can designate any frequency as a SKIP-frequency (up to 100). The receiver will skip this frequency during scanning. Designate any unwanted frequency (interference signals, etc.) as a SKIP-frequency.

Designating a SKIP-frequency

- 1 If you are in the Scanning Mode, press SCAN to enter the Manual Mode.
SCAN will disappear from the display.
- 2 Tune in, by any way, to a frequency you wish to specify as a SKIP-frequency.
- 3 Press SKIP.
The frequency is designated as a SKIP-frequency.

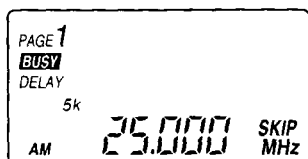

To cancel SKIP designation

Press SKIP again.



SKIP-frequency designation is effective for any of the Scanning Modes.

To display the SKIP-frequencies

Press +/- while holding down SKIP.
The SKIP-frequencies will be displayed one by one in ascending/descending order.

When there is no SKIP-frequency, the following display will appear momentarily, and then the receiver will return to the previous status.

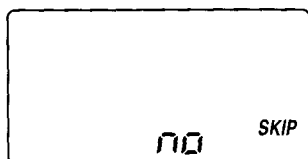

Note

You can designate up to 100 SKIP frequencies. If you try to designate a SKIP-frequency when there is already 100, the following display will appear momentarily, and then the receiver will return to the previous status.

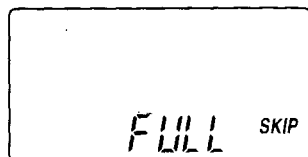

In this case, cancel a previously designated SKIP-frequency first.

To erase all SKIP memory at once

Press EXE, -, and SKIP simultaneously.
"dEL ALL SKIP" will flash in the display.

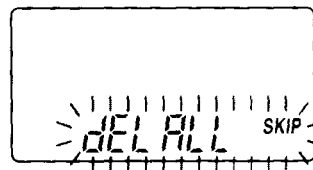

Hold the buttons down for 3 seconds or longer.
The flashing will stop and all the SKIP memory is erased.
The receiver will automatically enter the Band Scanning mode in the lowest band.

Adjusting scanning pause time

DELAY

DELAY is turned on by default. DELAY is indicated in the display, and scanning will not restart unless there is a reception break of 2 seconds. This is convenient, for example, when receiving a 2-way transmission, where there is a short break between the transmission.

To cancel DELAY

Press PRI/DELAY for 1 second or longer. DELAY will disappear, and the receiver resumes scanning the moment signal reception is broken during scanning pause.

Press PRI/DELAY for 1 second or longer again to turn DELAY on again.

Limiting scanning pause to 5 seconds (5-second pause mode)

- 1 If you are in the Scanning Mode, press SCAN to enter the Manual Mode (**SCAN** disappears).
- 2 Press SCAN for 1 second or longer. **SCAN** will be displayed and the decimal point of the frequency display will flash.

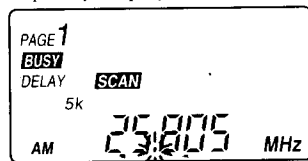

Normally, the receiver will remain in scanning pause until signal reception is broken or scanning is resumed manually.

In the 5-second pause mode, the receiver will pause scanning only for 5 seconds and automatically resume scanning at every stop.

To cancel the 5-second pause mode

Press SCAN to return to the Manual Mode. Then press SCAN lightly (less than 1 second) to re-enter the Scanning Mode.

Notes

- You can run Programmable Scanning in the 5-second pause mode by pressing SCAN for 1 second or longer while holding down ENTER.
- DELAY and the 5-second pause can be set individually.
- If the signal breaks in less than 5 seconds, the receiver resumes scanning in 2 seconds (with DELAY on) or at that moment (with DELAY off).
- If the signal is received for 5 seconds in the 5-second pause mode, the receiver will resume scanning at that moment regardless of the DELAY setting.
- To run Service Scanning in the 5-second pause mode, see "Service Scanning", page 17.

Adjusting frequency step and detection mode

You can adjust the frequency step and the detection mode when you are in the Manual Mode.

Adjusting the frequency step

- 1 If you are in the Scanning Mode, press SCAN to enter the Manual Mode.
- 2 Press STEP. With each press, the frequency step changes as follows.

AM, NFM:

→ 5k → 10k → 12.5k → 25k → 50k → 100k →

WFM:

→ 50k → 100k →

Adjusting the detection mode

- 1 If you are in the Scanning Mode, press SCAN to enter the manual mode.
- 2 Press MODE. With each press, the detection mode changes as follows.

→ AM → NFM → WFM →

Notes

- You cannot adjust the frequency step and the detection mode when you are in the Scanning Mode.
- The changes you have made in frequency step or detection mode are effective only in the current band. When you switch to a different band, the frequency step and detection mode will return to default (see "Frequency range of the bands", page 10).
- If the current frequency is not a step frequency when you change the frequency step, the frequency will automatically change to a step frequency.
- If you have changed the detection mode to WFM when you are in AM or NFM with the frequency step set to 25 kHz or less, the frequency step will automatically change to 50 kHz. If the current frequency is not a step frequency, it will automatically change to a step frequency.

Key protection

Press LIGHT/ⓘ for 1 second or longer. "ⓘ" will light in the display and all keystrokes will be neutralized. Use this feature to avoid operation by inadvertent keystrokes.

To cancel key protection

Press LIGHT/ⓘ again for 1 second or longer.

Turning on the light

Press LIGHT/ⓘ lightly (less than 1 second).

The light in the display window will light for about 10 seconds.

If you press any operation button while the light is on, the light will be lit for another 10 seconds.

To turn off the light

Press LIGHT/ⓘ again.

Notes

- The light is lit continuously when the receiver is run on external power (i.e., AC power adaptor or the car battery cord). To turn off the light, press LIGHT/ⓘ. Press again to turn the light on again.
- Pressing LIGHT/ⓘ will not light the window while the power is turned off.

Turning off the beep

You can turn the beep sound off.

- 1 If the power is on, press POWER to turn off power.
- 2 Press POWER while holding down EXE. "bP off" will be displayed before the power turns on.



To turn on the beep again

Repeat the above.

"bP on" will be displayed before the power turns on.



► Additional information

Troubleshooting

Should any problem persist after these tests, consult your nearest Sony dealer.

The power does not turn on.

- The batteries are exhausted.
 - Replace all batteries with new ones.
- The batteries are inserted with incorrect polarity, or the AC power cord or the car battery cord is not connected properly.
 - Power the receiver correctly.
- Key protection is active (ⓘ is present in the display).
 - Release key protection.

There is no sound.

- The batteries are exhausted.
 - Replace all batteries with new ones.
- The batteries are inserted with incorrect polarity, or the AC power cord or the car battery cord is not connected properly.
 - Power the receiver correctly.
- The VOL control is turned down completely.
 - Adjust it to a moderate level.
- The SQL control is turned up too far clockwise (towards MAX).
 - Adjust it properly (page 11).
- The earphone is plugged in.

Cannot operate.

- Key protection is on.
 - Turn off key protection.

Reception is weak or unsatisfactory.

- Weak batteries.
- The station is not tuned in correctly.
- The antenna is not attached properly.
- You are listening under inferior conditions. In a car or a building, try listening near a window.
- The detection mode does not match the band.
 - Select the detection mode that matches the band (page 31).

Scanning does not begin.

- The SQL control is turned down too far counterclockwise (towards MIN).
 - Adjust it properly (page 11).
- The reception is strong.
 - Resume scanning manually.
- You are in Memory Scanning and have only one station preset in the memory.

Scanning does not stop.

- Reception is weak (see "Reception is weak or unsatisfactory", above).
- SQL control is turned up too far clockwise (towards MAX).
 - Adjust it properly (page 11).

Will not pause scanning on a certain frequency.

- It is designated a SKIP frequency (page 28).

Cannot keep the receiver on scanning pause.

- Priority Scanning is active and the receiver received the priority channel (page 26).
- Scanning pause time is set to the 5-second pause mode (page 30).

The display is dim.

- Weak batteries.
 - Replace all batteries with new ones.
- The receiver is being used in extremely high temperatures or excessive humidity.

Cannot memorize a frequency

- The memorizing procedure is incorrect (page 22).

Cannot input a frequency with Direct Tuning.

- You took more than 10 seconds between the digits.
- You tried to input a frequency beyond the frequency range of the receiver.

Precautions

- Operate the scanning receiver only on recommended power sources. To use the receiver on AC power, use only the supplied or the recommended AC power adaptor. Do not use any other AC power adaptor. To use the receiver on a car battery, use only the recommended car battery cord. Do not use any other car battery cord.
- The nameplate indicating the operating voltage, power consumption, etc. is located at the bottom exterior of the receiver.
- Should any solid object or liquid fall into the set, remove the batteries and have the receiver checked by qualified personnel before operating it any further.
- Reception may be difficult or contain noise in vehicles or in buildings. Try listening near a window.
- Certain frequencies may be difficult to receive due to internal spurious signals, or birdies, inherent to the built-in oscillators used in a receiver. If the scanning receiver always pauses scanning at a certain frequency but seems to be receiving no signal, it may be receiving a birdie. In this case, designate it a SKIP-frequency.
- Be sure to adjust VOL to a moderate level before turning on the power or plugging in the earphone. There will be no sound when the receiver is scanning. Sudden reception (opening of the squelch) may cause unexpected loud sound and may cause hearing damage.
- If there is lightning when you are using an external antenna, disconnect AC power immediately from the wall outlet (if connected). Never touch the antenna during a lightning storm.

On batteries

Do not carry the batteries with coins or other metallic objects. It can generate heat if the positive and negative terminals of the batteries are accidentally contacted by a metallic object.

On handling

- When carrying the receiver, do not hold it by the antenna, the VOL control, or the SQL control.
- Do not bend or pull the antenna.
- Do not drop the receiver or expose it to mechanical shock. It may cause a malfunction.
- Do not leave the unit in a location near heat sources, or in a place subject to direct sunlight, excessive dust or sand, moisture, rain, mechanical shock, or in a car with its windows closed.
- The LCD display may become hard to see or slow down when using the unit at high temperatures (above 40°C/104°F) or at low temperatures (below 0°C/32°F). At room temperature, the display will return to its normal operating condition.

On cleaning

When the case becomes soiled, clean it with a soft cloth dampened with a mild detergent solution. Never use abrasive cleansers or chemical solvents, as they may mar the case.

If you have any questions or problems concerning your scanning receiver, please consult your nearest Sony dealer.

Specifications

Circuit system: Triple conversion superheterodyne

Frequency range:

25.000 ~ 1300.000 MHz

(excluding cellular phone band: 823.980 ~ 849.020 MHz and 868.980 ~ 894.020 MHz)

Detection mode: AM, NFM, WFM

Speaker: Approx. 36 mm (1 7/16 inches) dia., 8 ohms

Power output: 150 mW (at 10% harmonic distortion)

Output: Ⓜ jack (monaural minijack)

Power requirements: DC 6V, four size AA (R6) batteries

External power source: DC6V

Dimensions:

Approx. 64 x 177 x 44.3 mm (w/h/d) (2 5/8 x 7 x 1 3/4 inches) incl. projecting parts and controls, not including the helical antenna and the belt holder

Mass: Approx. 252 g (8.9 oz)

Approx. 382 g (13.5 oz) incl. alkaline batteries, helical antenna, and the belt holder

Supplied accessories

AC power adaptor (1)

Earphone (1)

Belt holder (1)

Helical antenna (1)

Frequency guidebook (1)

CD-ROM (1) (ICF-SC1PC only)

Serial port connecting cable (1) (ICF-SC1PC only)

Clamp filter (1) (ICF-SC1PC only)

Optional accessories

AC power adaptor AC-E60HG

Car battery cord

Location and function of controls

Front

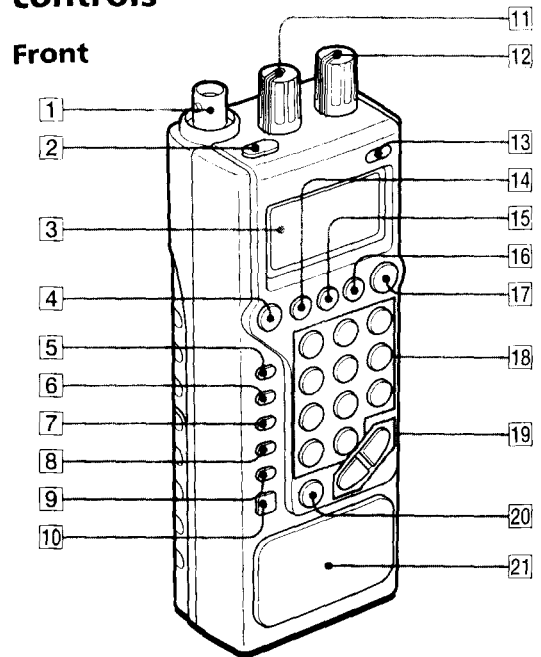

- 1 Antenna connector (BNC type)
- 2 POWER button
- 3 Display window
- 4 SVC (service) button
- 5 PRI (priority)/DELAY button
- 6 SKIP button
- 7 MODE (detection mode) button
- 8 STEP (frequency step) button
- 9 ERASE button
- 10 ENTER button
- 11 SQL (squelch) control
- 12 VOL (volume) control
- 13 LIGHT/☐ (key protect) button
- 14 BAND button
- 15 PAGE button
- 16 PRESET button
- 17 SCAN button
- Switches between Scanning Mode and Manual Mode.
- 18 Number keys
Inputs numbers for frequency (Direct Tuning), page and channel (Preset Tuning), or selects service band (Service Scanning).
The "10/0" key functions as "10" for page number selection, and as "0" for any other purpose.
- 19 +/- (up/down) keys
- 20 EXE•INTE (execute•Intelligent Memory) button
- 21 Speaker

Side/rear

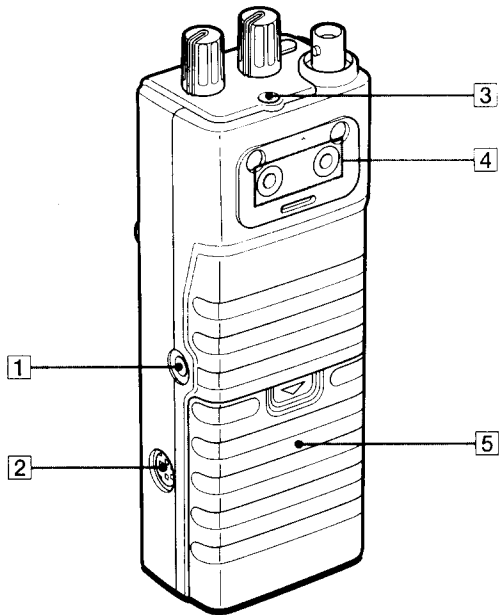

- 1 DC IN 6 V jack
- 2 Serial IOIO jack (ICF-SCIPC only)
Connects to the serial port (RS232C) on a personal computer using the supplied cable (refer to the Operating Instructions of the PC control software Sony Scanning Receiver Controller for more details).
- 3 Ⓜ (earphone) jack
- 4 Screw holes to attach belt holder
- 5 Battery compartment

Display

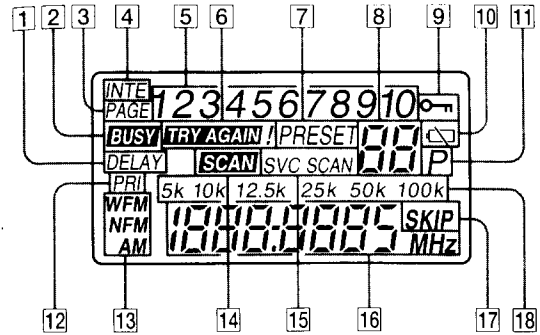

- 1 DELAY indication
Appears when the receiver is in the 2-second delay mode.
- 2 **BUSY** indication
Appears when there is reception (i.e., when the squelch is open).
- 3 PAGE indication
- 4 INTE (Intelligent Memory) indication
- 5 Page number/Intelligent Memory number indication
- 6 **TRY AGAIN !** indication
Appears when you have input a frequency that is outside the frequency range of this receiver.
- 7 PRESET indication
Appears when displaying the preset channel number (i.e., when presetting memory, running Memory Scanning, or Preset tuning).
- 8 Preset channel number/service band number indication
- 9 Ⓜ (key protect) indication
- 10 Battery warning indication
- 11 P (priority channel) indication
Appears when displaying the priority channel.
- 12 PRI (priority) indication
Appears when running Priority Scanning.
- 13 Detección mode indication
- 14 **SCAN** indication
Appears during Scanning Mode.
- 15 SVC SCAN (Service Scanning) indication
- 16 Frequency display
- 17 SKIP indication
- 18 Frequency step indication

