

**Uniden®**

**UM380**

**WATERPROOF DSC MARINE RADIO**

**RADIO MARITIME ASN HYDROFUGE  
RADIO MARÍTIMA DSC IMPERMEABLE**



**OWNER'S MANUAL  
GUIDE D'UTILISATION  
GUÍA DE UTILIZACIÓN**

## MAKING A DISTRESS CALL

Lift the red cover. Press and hold the **DISTRESS** button for three seconds. Your radio transmits your boat's location every few minutes until you receive a response.

 **NOTE: If the radio displays *Enter User MMSI*, cancel the automatic distress call and make a normal voice distress call.**

### Making a Voice Distress Call

**Speak slowly - clearly - calmly.**

For future reference, write your boat's name & call sign here:



Lift the red cover and press the **DISTRESS** button.

1. Make sure your radio is on.
2. On the radio, press the **16/9-TRI** button to switch to Channel 16 (156.8 MHz). (If the corner of the display does not show 16, press the **16/9-TRI** button again until it does.)
3. Press the **PUSH TO TALK** button on the microphone and say: "**MAYDAY -- MAYDAY -- MAYDAY.**"
4. Say "**THIS IS** *{name of your boat (three times) and call sign/boat registration number (once)}*."
5. Repeat "**MAYDAY** *{name of your boat}*" once.
6. Tell where you are: (what navigational aids or landmarks are near, or read the latitude and longitude from your GPS).
7. State the nature of your distress (e.g. are you sinking, medical emergency, man overboard, on fire, adrift, etc. ).
8. State the type of assistance you need (medical, towing, pumps, etc.).
9. Give number of persons aboard and conditions of any injured persons.
10. Estimate present seaworthiness of your ship (e.g. how immediate is the danger due to flooding or fire or proximity to shore).
11. Briefly describe your ship, giving ship name (e.g. "Blue Duck is 32 foot cabin cruiser, white hull, blue deck house.")
12. Say: "**I WILL BE LISTENING ON CHANNEL 16.**"
13. End message by saying "**THIS IS** *{name or call sign of your boat}*, **OVER.**"
14. Release the **PUSH TO TALK** button and listen.

**If you do not get an answer after 30 seconds, repeat your call, beginning at step 3, above.**

## FAIRE UN APPEL DE DÉTRESSE

Soulevez le couvercle rouge. Maintenez la touche **DISTRESS** enfoncée pendant trois secondes. La radio transmet la position de votre bateau à intervalles réguliers de quelques minutes, jusqu'à ce que vous receviez une réponse.

 **REMARQUE** : Si la radio affiche *Enter User MMSI (Entrer l'ISMM de l'utilisateur)*, annulez l'appel de détresse automatique et faites un appel de détresse couvercle rouge et vocal standard.



Soulevez le couvercle rouge et appuyez sur la touche **DISTRESS**.

### Faire un appel de détresse vocal

**Parlez lentement – clairement – calmement.**

Pour toute référence ultérieure, transcrivez ci-dessous le nom et l'indicatif d'appel de votre bateau :

1. Vérifiez si votre radio est en marche.
2. Appuyez sur la touche **16/9-TRI** de la radio afin de commuter au canal 16 (156,8 MHz). (Si le canal 16 n'apparaît pas à l'affichage, appuyez de nouveau sur la touche **16/9-TRI** jusqu'à ce qu'il soit affiché.)
3. Appuyez sur le bouton de microphone **PUSH TO TALK** et dites : "**MAYDAY - MAYDAY - MAYDAY**".
4. Donnez l'identité de votre navire en disant : "**ICI {nom de votre bateau (trois fois) ou indicatif d'appel et le numéro d'identification de votre bateau (une fois)}**".
5. Dites "**MAYDAY {nom ou indicatif d'appel de votre bateau} une fois**".
6. Donnez votre position : (quels sont les points de repère ou aides à la navigation près de vous ou lisez les coordonnées de longitude et de latitude apparaissant sur votre dispositif GPS).
7. Révélez la nature de votre détresse (par exemple, nous sommes en train de couler, urgence médicale, un homme à la mer, un incendie, nous sommes à la dérive, etc).
8. Révélez la nature de l'assistance désirée (médicale, remorquage, essence, etc.)
9. Donnez le nombre de personnes à bord et les conditions des blessés, s'il y en a.
10. Donnez la condition de navigabilité actuelle de votre navire, tel que le degré de l'urgence par rapport à l'inondation, à l'incendie ou à votre proximité de la côte.
11. Donnez une brève description de votre navire en donnant le nom du bateau (par exemple, "Blue Duck est un yacht de croisière de 32 pieds, avec une coque blanche et un rouf bleu.").
12. Dites : "**JE VAIS ÉCOUTER SUR LE CANAL 16**".
13. Terminez le message en disant "**ICI {nom ou indicatif d'appel de votre bateau}, À VOUS**".
14. Relâchez le bouton **PUSH TO TALK** du microphone et écoutez.

**Si vous n'obtenez pas de réponse après 30 secondes, répétez l'appel en commençant à l'étape 3 ci-dessus.**

# CÓMO HACER UNA LLAMADA DE SOCORRO

Levante la tapa roja. Mantenga oprimido el botón **DISTRESS** por tres segundos. La radio transmitirá la localidad de su nave cada cuantos minutos hasta que reciba una respuesta.

🗨️ **Nota:** Si la radio exhibe (*Inserte el MMSI del usuario*), **cancela la llamada de socorro automática y haga una llamada de socorro normal por voz.**



Levante la tapa roja y oprima el botón **DISTRESS**.

## Cómo hacer una llamada de socorro por voz

**Hable despacio -- claro -- y con calma.**

Para acordarse en el futuro, escriba el nombre y la señal de su nave aquí:

1. Asegúrese de que la radio está encendida.
2. En la radio, oprima el botón **16/9-TRI** para cambiar al canal 16 (156.8 MHz). (Si la esquina de la pantalla no muestra 16, oprima el botón **16/9-TRI** otra vez hasta que lo haga.)
3. Oprima el botón **PUSH TO TALK** (Oprima para hablar) en el micrófono y diga: "**MAYDAY --- MAYDAY--- MAYDAY.**"
4. Diga "**ESTE ES** {nombre de su nave (tres veces) y la señal/ número de registración de la nave (una vez)}."
5. Diga "**MAYDAY** {nombre o señal de su nave}" una vez.
6. Describa donde se encuentra: (ayudas de navegación o marcas destacadas cercanas, o lea la latitud y la longitud en su GPS).
7. Describa la clase de su socorro, ej., se está hundiendo, emergencia médica, hombre al agua, hay fuego, está a la deriva, etc.
8. Describa el tipo de asistencia que necesita (atención médica, remolque, bombas, etc.).
9. Describa la cantidad de personas abordo y las condiciones de cualquier persona lesionada.
10. Estime la navegabilidad actual de su nave, ej., cuanto de inmediato es el peligro de inundación o de incendio o proximidad a la costa.
11. Describa brevemente su nave (ej., "Blue Duck es un yate de 32 pies, casco blanco, cabina azul").
12. Diga: "**ESTARÉ ESCUCHANDO EN EL CANAL 16.**"
13. Termine el mensaje diciendo: "**ESTE ES** {nombre o señal de su nave}, **OVER.**"
14. Suelte el botón **PUSH TO TALK** y escuche.

**Si no recibe una contestacion dentro de 30 segundos, repita su llamada, comenzando con el paso 3, descrito arriba.**

**Visite [www.westmarine.com](http://www.westmarine.com) para bajar el manual en español de la radio UM380.**



# Contents

**Introduction ..... 2**  
 Features ..... 2  
 Manual overview ..... 2

**Getting Started ..... 3**  
 What's included ..... 3  
 Parts of the Radio ..... 4  
 Parts of the Microphone ..... 5  
 Turning on the Radio ..... 5  
 Setting the UIC Channel Mode  
 (USA/CAN/INT) ..... 6

**How It Works ..... 6**  
 Normal mode operation ..... 7  
 Scan mode ..... 9  
 Weather mode ..... 11

**Using Your Radio ..... 12**  
 Using Your Radio ..... 12  
 Making a voice MAYDAY call ..... 13  
 Setting the volume ..... 13  
 Setting the squelch level ..... 13  
 Changing the channel ..... 13  
 Making a transmission ..... 13  
 Boosting the transmission power ..... 14  
 Choosing Triple Watch or Dual Watch ..... 14  
 Using FIPS codes for weather alerts ..... 15  
 Changing display and sound options ..... 16  
 Setting the GPS position manually ..... 16

**Using Digital Selective Calling (DSC) ..... 18**  
**Features ..... 18**  
 What is DSC? ..... 18  
 What is an MMSI number? ..... 18  
 Entering MMSI numbers ..... 19  
 Using the Directory ..... 20  
 Making DSC Calls ..... 21  
 Making an automatic distress call ..... 23  
 Receiving a DSC call ..... 24

Test Calls ..... 25  
 Position Request and Reply ..... 27  
 Putting the radio into standby ..... 28  
 Disabling automatic channel switching ..... 28

**Installing the Hardware ..... 29**  
 Mounting the radio ..... 29  
 Connecting the radio ..... 30  
 Connecting to a GPS receiver ..... 31  
 Connecting to a Chartplotter ..... 33  
 Connecting to an External Speaker ..... 33

**Maintenance and Troubleshooting ..... 34**  
 Engine Noise Suppression ..... 35

**Specifications ..... 36**  
 Radio Specifications ..... 36

**Reference Tables ..... 37**  
 Channel descriptions and  
 what they mean ..... 37  
 US Marine Channels and Frequencies ..... 38  
 Canadian Marine Channels and  
 Frequencies ..... 39  
 International Marine Channels and  
 Frequencies ..... 41  
 Weather Channels and Frequencies  
 (US, CAN, and INT) ..... 43  
 Emergency Alert System (SAME)  
 Information ..... 43  
 No Response Event Code ..... 45  
 NMEA Operation ..... 46  
 NMEA Output ..... 46

**Regulations and Safety Warnings ..... 46**  
**Three Year Limited Warranty ..... 47**



# INTRODUCTION

## Features

- Waterproof Design - Complies with JIS4 water-resistant standards, which means the radio is resistant to damage from rain or splashing water.
- Large, dot matrix display
- Advanced DSC Class D functions, including Test Calling
- Memory scan mode - Lets you save channels to memory and monitor them in quick succession.
- Transmitter Power Level Select - Lets you boost the transmitter power from 1 watt to 25 watts for added transmission distance.
- Battery level display and tone - Sounds an alert tone if the battery voltage goes too high or too low.
- Triple Watch Operation - Checks the Coast Guard Distress/Hailing channels 16 and 9 in the background.
- All marine VHF channels for the U.S., Canada, and international waters
- National Oceanic and Atmospheric Administration (NOAA) weather channel watch - Sounds a warning tone when a hazard alert is issued for your area.

## Manual overview

### Conventions

This manual uses several different type styles to help you distinguish between different parts of the radio:

- **BOLD SMALL CAPITALS** indicates an actual button or knob on the radio or microphone.
- **Upper and Lower Case bold** indicates a connector or label on the radio.
- *Italics* indicate text on the display, such as menu options, prompts, and confirmation messages.

Term	Meaning
DSC	Digital Selective Calling. A VHF radio standard for communicating among boats and sending automated distress calls.
FIPS	Federal Information Processing Standard. A set of location codes roughly equivalent to your county codes.
WX	Weather Radio
GPS	Global Positioning System
NMEA	National Marine Electronics Association. The organization that governs standards for electronic equipment used on boats. NMEA 0183 is the standard for serial data communication used by GPS.
MMSI	Maritime Mobile Service Identity number. A unique, nine-digit number that identifies you and your boat when making DSC calls. It is also used by the Coast Guard if you send an automated distress call.
Station	Any DSC radio, whether it's operated on a boat, at a marina, or by a shore station.

# GETTING STARTED

## What's included

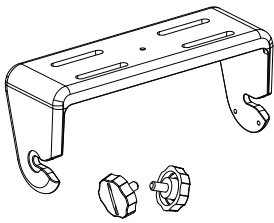

Mounting Bracket and Knobs

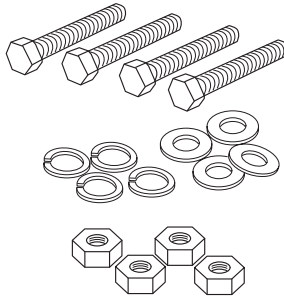

Mounting Hardware

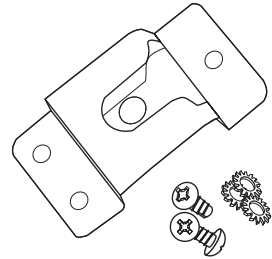

Microphone Hanger and Mounting Hardware

## Parts of the Radio

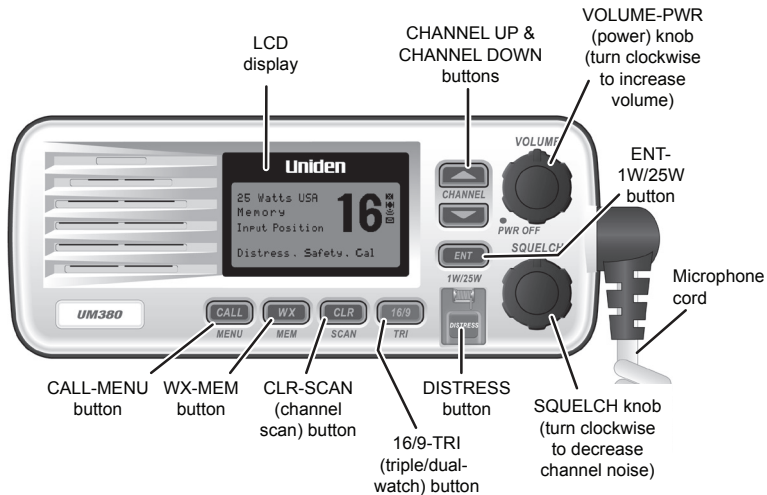

Button	Press to...	Press and hold to...
ENT-1W/25W	Choose an option on a menu or to display the GPS data.	Change the transmit power (see page 14).
CHANNEL UP	Move up one channel at a time.	Move quickly up the channels.
CHANNEL DOWN	Move down one channel at a time.	Move quickly down the channels.
16/9-TRI	1st press: Go to Channel 16. 2nd press: Go to Channel 9. 3rd press: Go back to the original channel.	Go into Triple Watch or Dual Watch mode (see page 14).
CLR-SCAN	Go to previous menu or cursor position in menu mode.	Start scanning the channels saved in memory.
WX-MEM	Listen to the current weather conditions in your area.	Save a channel into memory or remove a channel from memory.
CALL-MENU	Display the call menu.	Display the normal menu.
DISTRESS	Select the nature of your distress for a distress call.	Transmit a distress call.



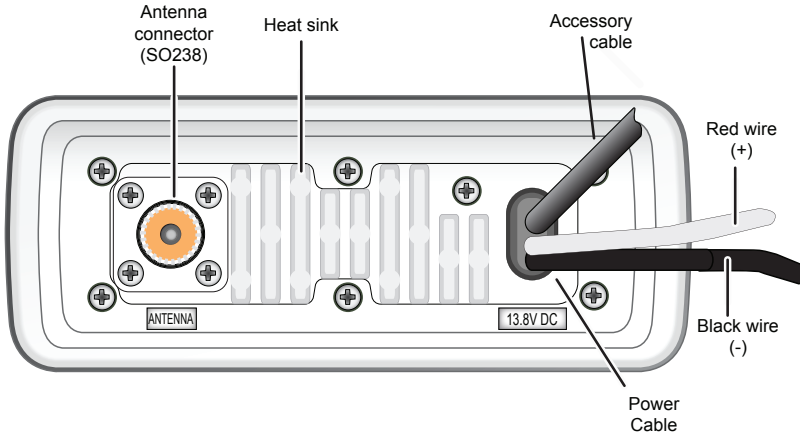

Connector/Cable	Connects to...	For details, see ...
Antenna connector	External VHF antenna with a male PL259 (SO238) connector and 50 $\Omega$ impedance. Minimum 4 ft, 3dB rated antenna for sailboats, 8 ft, 6 dB rated for power boats.	Connecting the radio (see page 30).
Power cable	Nominal 13.8 VDC power supply with negative ground (10.5 VDC to 16.0 VDC) (Red wire +, black wire -).	Connecting the radio (see page 30).
Accessory cable	GPS receiver, GPS chartplotter.	Connecting accessories (see page 31).

### Parts of the Microphone

Button	Press to...	Press and hold to...
PUSH-TO-TALK	Cancel scanning and stay on a channel.	Talk on a channel.



### Turning on the Radio

Turn the **VOLUME-PWR** knob clockwise to turn on the radio. As it powers on, the radio displays the user MMSI number; if there is no MMSI set, the radio displays *MMSI not entered*.

When it powers on, the radio selects the last channel used.



## Setting the UIC Channel Mode (USA/CAN/INT)

The radio comes preset to use the UIC channels assigned for the United States. If you are operating in an area that uses Canadian or international UIC channels, you will need to change the channel mode.

Press and hold -

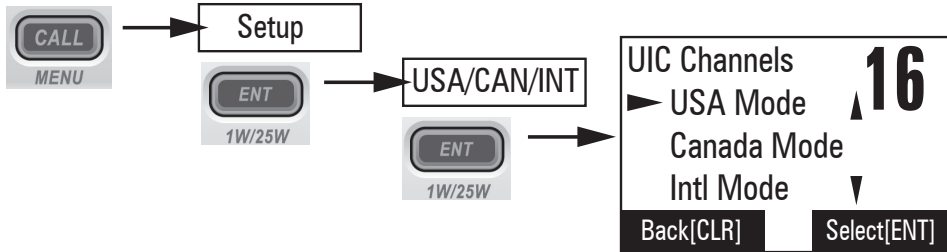

1. Press and hold **CALL-MENU** to display the normal menu, and choose the Setup sub-menu.
2. Select **USA/CAN/INT**. The screen displays the UIC channel setup.
3. Choose the channel mode you want to use: US (*USA Mode*), Canadian (*Canada Mode*), or international (*Intl Mode*).
4. Press **ENT-1W/25W**. The radio activates the new channel mode and exits the menu.

## HOW IT WORKS

Your radio has three basic modes of operation:

Mode	What It Does	Use It When	To Turn it on./off...
Normal	Monitors a single marine radio channel and lets you talk on that channel.	You want to talk to another station on a specific channel.	(default mode)
Scan	Monitors all the channels you save into memory.	You have a small group of channels you use most often and want to check them for traffic.	Press and hold the <b>CLR-SCAN</b> button.
Weather	Monitors the selected NOAA weather channel.	You want to hear the current and forecasted weather in your area.	Press the <b>WX-MEM</b> button.

In addition to the three basic operation modes, your radio also provides three different “watch” modes which you can activate during any of the three basic modes. In these watch modes, the radio briefly checks for activity on a specific channel then returns to its previous mode.



Watch Mode	What It Does	Use It When	To Turn it on./off...
Weather Alert	Checks for alerts on the last weather channel you used every seven seconds.	You want to be made aware of severe weather conditions in your area.	conditions in your area. Select <i>WX Alert Mode</i> in Setup submenu, and then choose <i>ON</i> or <i>OFF</i> .
Triple	Checks for activity on channels 16 and 9 every two seconds.	You want to monitor a channel yet maintain a watch on channels 16 and 9.	Press and hold <b>16/9-TRI</b> for two seconds.
Dual	Checks for activity on channel 16 every two seconds.	You want to monitor a channel yet maintain a watch on channel 16.	Change Triple Watch to Dual Watch in the setup menu, then press and hold <b>16/9-TRI</b> for two seconds.

**NOTE: You are required to monitor channel 16 whenever your boat is underway. You should have either Triple Watch or Dual Watch on at all times.**

### Normal mode operation

Normal mode monitors whatever channel you select, and you can transmit on that channel also. While using normal mode, the display lets you see the following information (not all indicators will display at the same time):

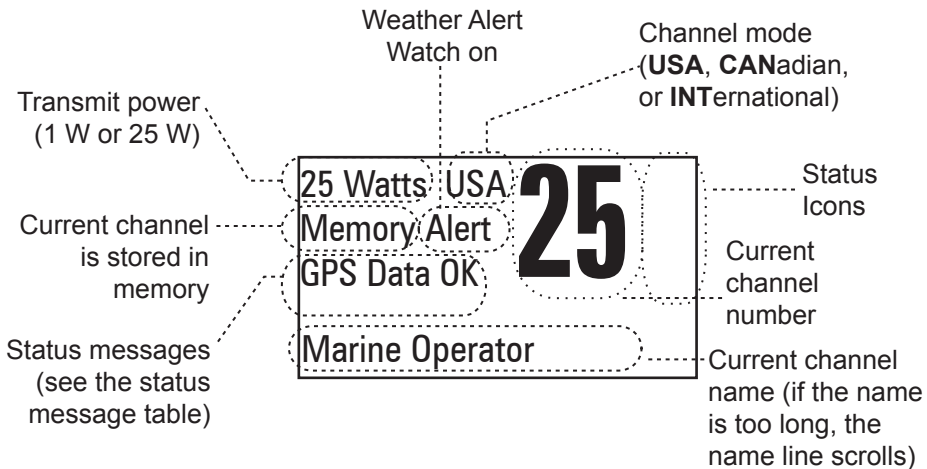

Message	Meaning
GPS Data OK	The radio is receiving valid GPS data.
Check GPS	The radio is not receiving valid GPS data: check the GPS status screen and the GPS connection.





Message	Meaning
Input Position	The radio does not have valid GPS data. (see Setting the GPS position manually on page 16).
Battery Low	The battery voltage output is too low (below 10.5 VDC).
Battery High	The battery voltage output is too high (above 16.0 VDC).

### Using the radio in normal mode

- To transmit, press and hold **PUSH TO TALK** on the microphone. Release the button when you are finished talking.
- For the best sound quality, hold the microphone about two inches from your mouth while you're talking.
- Press **CHANNEL UP** on the radio or the microphone to move up one channel at a time. Press and hold either button to scroll quickly up the channels.
- Press **CHANNEL DOWN** on the radio or the microphone to move down one channel at a time. Press and hold either button to scroll quickly down the channels.
- To change the transmit power, press and hold the **ENT-1W/25W** for two seconds. The transmit power switches between 1 watt and 25 watts each time you press and hold **ENT-1W/25W**.

### Normal mode with Weather Alert Watch

If you activate Weather Alert Watch while operating in normal mode, the radio checks the most recently-used weather channel every seven seconds. If it detects a weather alert for your area, it will change the channel to the last-used weather channel. The radio will not check the weather channel while you are actively transmitting; it waits until your transmission is finished and then checks the weather channel.

To turn Weather Alert Watch on or off, press and hold **CALL-MENU** while the radio is idle. Select *Setup* and then *WX Alert Mode*. Use **CHANNEL UP** and **CHANNEL DOWN** to choose *WX Alert Mode* setting **ON** or **OFF**.

### Normal mode with Triple and Dual Watch

If you activate Triple Watch while operating in normal mode, the radio checks channels 16 and 9 every two seconds; with Dual Watch turned on, the radio only checks channel 16. The radio will not check channels 16 or 9 while you are actively transmitting; it waits until your transmission is finished and then checks the channels.

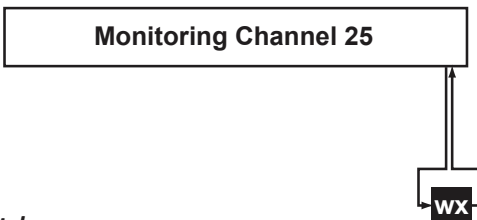

Every 7 seconds, the radio checks the most recently-used weather channel.  
**with WX Alert on**





Press and hold **16/9-TRI** on the radio for two seconds to turn Triple/Dual Watch on or off. (To change between Triple or Dual Watch, see page 14.)

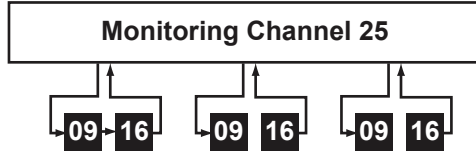

**Triple Watch:** Every 2 seconds, the radio checks channels 9 & 16.

### Normal mode with both Weather Alert and Triple/Dual Watch

You can activate Weather Alert Watch and Triple/ Dual Watch at the same time. The radio performs both checks at their scheduled time.

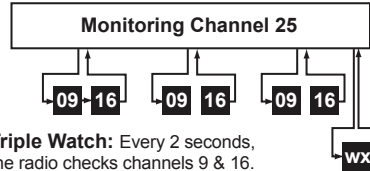

**Triple Watch:** Every 2 seconds, the radio checks channels 9 & 16.

**WX Alert :** Every 7 seconds, the radio checks the most recently-used weather channel.

### Scan mode

You can save channels into memory and then use scan mode to monitor those channels. When the radio detects a signal on a channel, it pauses on that channel as long as the signal is received; when the transmission stops, the radio will continue scanning.

When it detects a signal, the radio stays on the channel until you press the **CHANNEL UP** button or the signal stops.

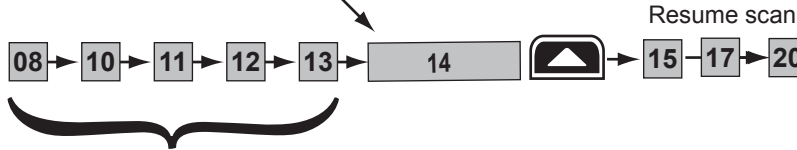

The radio scans about 5 channels in 1 second.

In scan mode, you can get the following information from the display (some indicators will not always be displayed).

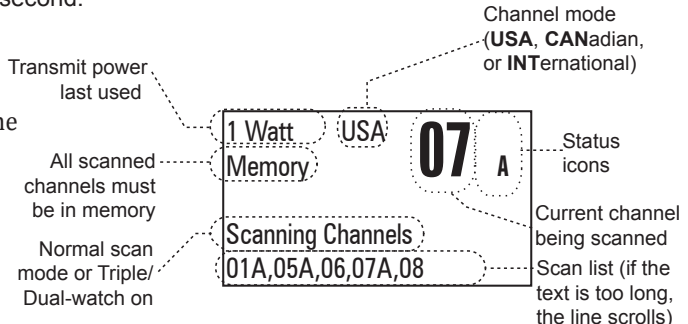



### Using the radio in scan mode

- You cannot transmit while in scan mode.
- You must have two or more channels in memory to start a scan.
- To save a channel into memory, select the channel, then press and hold **WX-MEM** for two seconds. Memory will show on the display.
- To remove a channel from memory, set the radio to that channel, then press and hold **WX-MEM** for two seconds. Memory will no longer show on the display.
- To activate scan mode, press and hold **CLR-SCAN**. Press and hold **CLR-SCAN** again to return to the previous mode.
- When the radio automatically stops on a channel, press **CHANNEL UP** to leave that channel and resume scanning.
- To end the scan, press the microphone's **PUSH TO TALK**, **CALL-MEM**, or **WX-MEM** buttons. The radio remains on the last scanned channel.

### Scan mode with Weather Alert Watch

If you activate Weather Alert Watch while operating in scan mode, the radio checks the most recently-used weather channel every seven seconds, then continues scanning the next channel in memory.

To turn Weather Alert Watch on or off, press and hold **CALL-MENU** while the radio is idle. Select *Setup* and then *WX Alert Mode*. Use **CHANNEL UP** and **CHANNEL DOWN** to choose *WX Alert Mode* setting *ON* or *Off*.

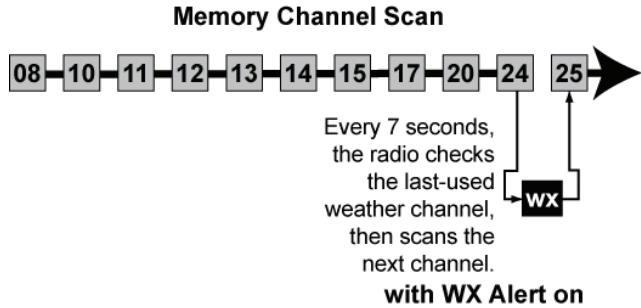

### Scan mode with Triple and Dual Watch

If you activate Triple Watch while operating in scan mode, the radio checks channels 16 and 9 every two seconds, then goes on to scan the next channel; with Dual Watch turned on, the radio only checks channel 16.

Press and hold **16/9-TRI** on the radio for two seconds to turn Triple/Dual Watch on or off. (To change between Triple or Dual Watch, see page 14.)

Press and hold the **CLR-SCAN** key to turn off Scan mode and set the radio to Triple/Dual Watch mode.

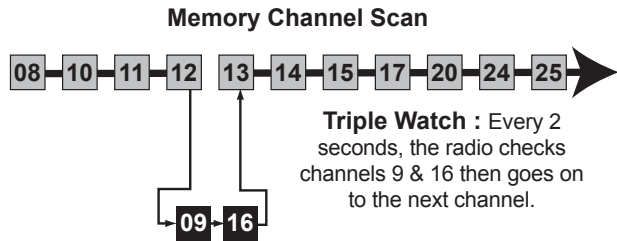



### Scan mode with both Weather Alert and Triple/Dual Watch

You can activate Weather Alert Watch and Triple/Dual Watch at the same time. The radio performs both checks at their scheduled time.

### Memory Channel Scan

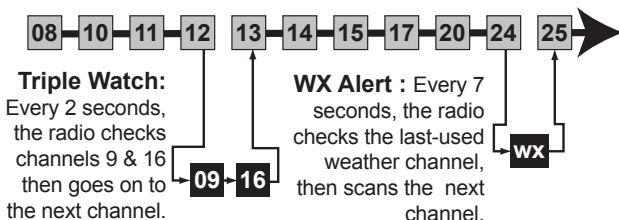

### Weather mode

In cooperation with the FCC, NOAA also uses the weather channels to alert you of other hazards besides weather (child abduction alerts, nuclear, biological, etc.). In weather mode, the radio monitors one of the ten NOAA weather channels. If any type of alert is received for your area, the radio sounds an alert tone and displays the type of alert. In weather mode, the display shows the following:

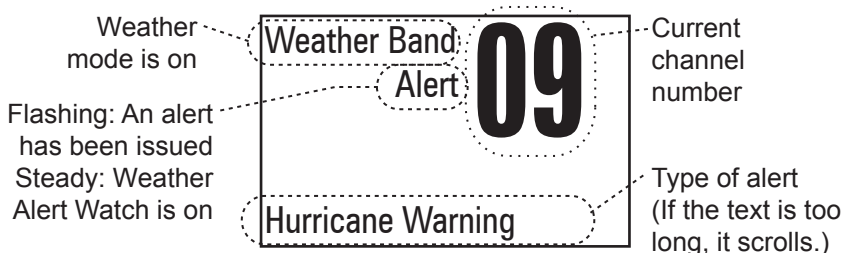

### Using the radio in weather mode

- You cannot transmit while in weather mode.
- To enter weather mode, press **WX-MEM**.
- Weather mode can filter out alerts that do not affect your location if the location code (FIPS code) of the alert is entered in your radio (see page 15). If you have no FIPS codes programmed into your radio, the radio will notify you of all alerts in any area.
- To turn off the radio's alert tone, press any button.
- To cancel weather mode and return to the previous marine channel, press the **WX-MEM** button again.

### Weather mode with Weather Alert Watch

Because weather mode already monitors the weather channels, you don't need Weather Alert Watch to check the weather channel every seven seconds. If you activate Weather Alert Watch while operating in weather mode, it operates as a type of "sleep mode": the radio stays on the weather channel and mutes the speaker. If an alert is detected for your area, the radio sounds an alert tone and turns the speaker back on. This mode is very useful when you are anchoring for the night but want to stay informed of any hazards in your area.

To turn Weather Alert Watch on or off, press and hold **CALL-MENU** while the radio is idle. Select *Setup* and then *WX Alert Mode*. Use **CHANNEL UP** and **CHANNEL DOWN** to choose *WX Alert Mode* setting *ON* or *Off*.



### Weather mode with Triple and Dual Watch

If you activate Triple Watch while operating in weather mode, the radio checks channels 16 and 9 every two seconds; with Dual Watch turned on, the radio only checks channel 16.

Press and hold **16/9-TRI** on the radio for two seconds to turn Triple/Dual Watch on or off. (To change between Triple or Dual Watch, see page 14.)

### Monitoring Weather Channel WX08

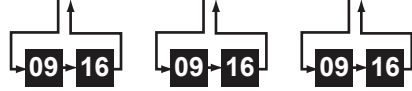

**Triple Watch:** Every 2 seconds, the radio checks channel 9, then channel 16.

## USING YOUR RADIO

To display the radio call menu, press **CALL-MENU**. To display the radio normal menu, press and hold **CALL-MENU**. The menu has the following options:

Press and hold -

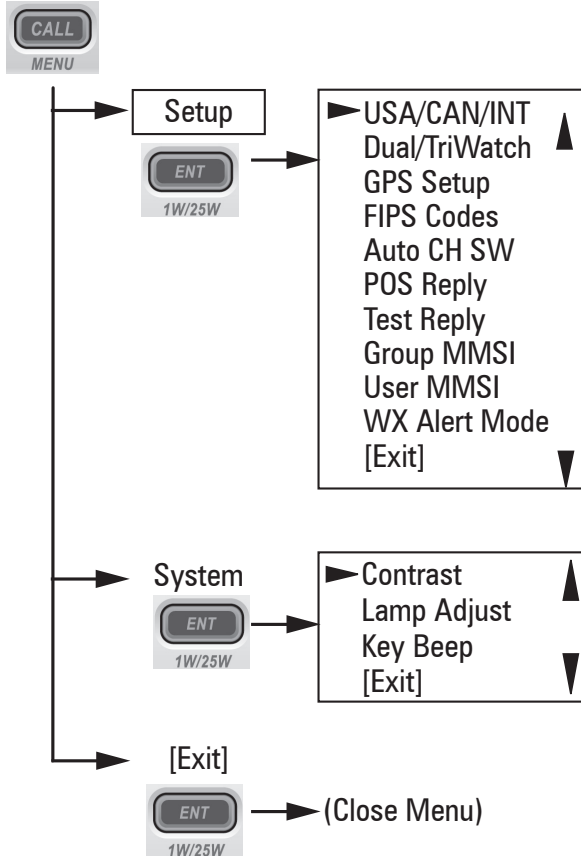

### Using Your Radio

- An arrow on the left side indicates the current selection.



- Press **CHANNEL UP** on the radio or the microphone to move up a line in the menu; if you are at the top line in the menu, the cursor jumps to the bottom of the menu.
- Press **ENT-1W/25W** to choose the selected item.
- Press **CHANNEL DOWN** on the radio or the microphone to move down a line in the menu; if you are at the bottom line of the menu, the cursor jumps to the top of the menu.
- Press **CLR-SCAN** to go back to the previous menu screen.
- From any menu screen, choose *Exit* or press and hold **CALL-MENU** to close the menu screen.

## Making a voice MAYDAY call

(see inside front cover)

## Setting the volume

Turn the volume knob clockwise to increase the speaker volume; turn it counter-clockwise to decrease the volume.

## Setting the squelch level

The squelch feature reduces the level of static on the speaker by filtering out the background channel noise. At the lowest squelch level, the speaker plays all radio signals, including any noise on the channel. Setting the squelch level higher filters out channel noise and lets only actual radio transmissions through.

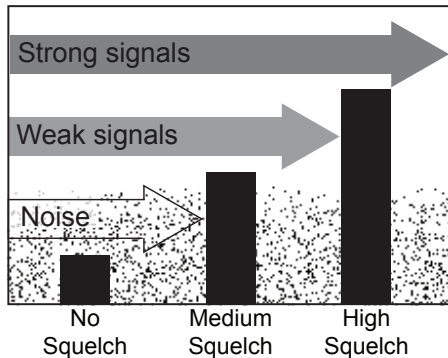

While listening to a channel, adjust the SQUELCH knob until the noise is filtered out and you can only hear the transmission. If you switch to a channel with a lot of noise or with a weak transmission, you may need to adjust the squelch level again.

**NOTE:** Setting the squelch level too high may prevent you from hearing weaker transmissions. If you are having difficulty hearing a transmission, try setting the squelch level lower.

## Changing the channel

Press **CHANNEL UP** and **CHANNEL DOWN** briefly to scroll through the channels one channel at a time. Press and hold **CHANNEL UP** or **CHANNEL DOWN** to quickly scroll through the channels.

## Making a transmission

To make a transmission, press and hold the microphone **PUSH TO TALK** button. Release the **PUSH TO TALK** button when you're finished talking to let the other party respond.

- To prevent stuck microphone problems or situations where **PUSH TO TALK** is pushed accidentally, the radio limits your talk time to 5 minutes in a single transmission. If you talk for over 5 minutes continuously, the display shows *RELEASE MIC BUTTON*.
- For the best sound quality, hold the microphone about two inches away from your mouth.
- You cannot transmit while the radio is in weather mode or scan mode.
- See the channel lists beginning on page 37 for a list of receive-only channels.

## Boosting the transmission power

In most situations, the 1 Watt transmission power is all you need. If you find yourself far away from other stations and have trouble getting a response, you may need to boost the transmission power from 1 Watt to 25 Watts:

1. Select the channel you want to transmit on.
2. Push and hold **ENT-1W/25W** for two seconds. The display shows 25 Watts in the upper left hand corner.
3. The transmit power remains at 25 Watts until you change the setting back. Push and hold **ENT-1W/25W** for two seconds. The display shows 1 Watt.

 **NOTE: Don't forget to change the transmission setting back to 1 Watt when you move closer to other stations.**

 **NOTE: By default, when you change to channel 16, the radio automatically boosts the power to 25 Watts. Be sure to change the power back to 1 Watt if you are not making an emergency transmission.**

Some channels (for example, channels 13 and 67) limit the power of transmission to 1 Watt so that there is less interference between boaters attempting to use the channel at the same time. If you switch to one of these channels, the radio changes back to 1 Watt automatically. See the channel lists beginning on page 37 for a list of power-restricted channels.

## Choosing Triple Watch or Dual Watch

In Triple Watch mode, the radio briefly checks channels 16 and 9 every two seconds. In Dual Watch mode, the radio checks channel 16 only. Generally, Triple Watch is used in areas where channel 9 is used as a hailing frequency while Dual Watch is used in areas where channel 16 is used for distress and hailing. Your radio comes set to use Triple Watch; if you want to use Dual Watch instead, you will have to select it in the setup:

Press and hold -

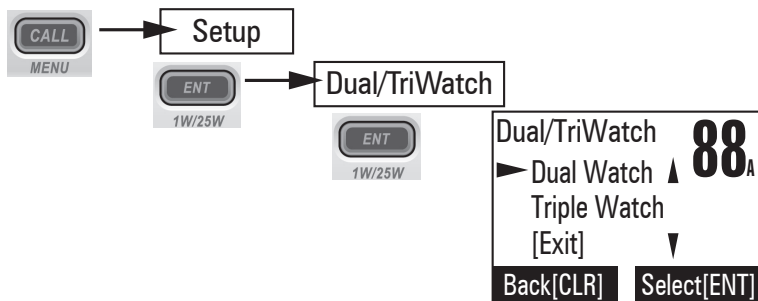

1. Press and hold **CALL MENU** to display the normal menu.
2. Select *Setup* and then *Dual/Tri Watch*.



3. Choose Dual Watch and press **ENT-1W/25W**. The radio activates the new setting and returns to the Setup menu.
4. To reactive Triple Watch, repeat the procedure described above, but choose Triple Watch in step 3.

## Using FIPS codes for weather alerts

The US National Weather Service established 6-digit Federal Information Processing System (FIPS) codes to issue weather alerts in specific areas. You can choose which areas you want to hear alerts for by entering these FIPS codes in your radio. This can prevent you from being bothered by events that are far from where you are boating. The radio only sounds the alert tone if an incoming FIPS code matches one of the areas you selected.

- For more information about how the NWS uses FIPS codes, see the NWS website: [www.nws.noaa.gov/nwr/nwsfipschg.htm](http://www.nws.noaa.gov/nwr/nwsfipschg.htm).
- To see an index of FIPS codes by state, see the website of the National Institute of Standards and Technology (NIST): [www.itl.nist.gov/fipspubs/co-codes/states.htm](http://www.itl.nist.gov/fipspubs/co-codes/states.htm).
- For information on the Canadian implementation of FIPS codes, called Canadian Location Codes, see the website of the Meteorological Service of Canada (MSC): [http://www.msc.ec.gc.ca/msb/weatheradio/transmitter/index\\_e.cfm](http://www.msc.ec.gc.ca/msb/weatheradio/transmitter/index_e.cfm)

 **NOTE: If you travel outside the areas you have entered into your radio, you may not hear alerts that affect your new location. Be sure to enter the FIPS codes of all the areas you plan to travel to during this trip.**

Follow the steps below to edit the list of FIPS codes. You can store up to 30 different FIPS codes in your radio.

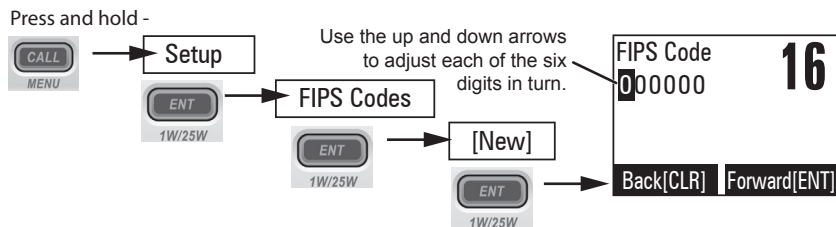

Display the normal menu and choose the *Setup* sub-menu.

1. Select FIPS Codes. The screen displays any previously-entered FIPS codes.
2. To add a new FIPS code, select *New*.
3. Use **CHANNEL UP** and **CHANNEL DOWN** to change the first of the six digits; **CHANNEL UP** increases the number and **CHANNEL DOWN** decreases it.
4. When the first digit is correct, press **ENT-1W/25W**. The cursor moves to the next digit. Enter the remaining five digits of the FIPS code in the same way. If you make a mistake while entering a digit, press **CLR-SCAN** to erase the wrong number and moved the cursor to the left digit.
5. When the sixth digit is correct, press **ENT-1W/25W**. The radio displays the new FIPS code and asks you to confirm. To save this code, select *Yes*; to cancel this code, select *No*. The radio returns to the list of FIPS codes.
6. To change an existing FIPS code, select the code you want to change.



7. To delete the FIPS code, select *Delete*. To edit the code, select *Edit*, then use **CHANNEL UP** and **CHANNEL DOWN** buttons to change each of the six digits.
8. When you are satisfied with the list of FIPS codes, select *Exit* to close the menu screen.

## Changing display and sound options

### Contrast

Your radio display has 10 levels of contrast. To adjust the contrast, press and hold **CALL-MENU** while the radio is idle. Select *System* and then *Contrast*. Use **CHANNEL UP** and **CHANNEL DOWN** to change the contrast to your desired level.

To restore the default contrast setting, turn the radio off. Press **CALL-MENU** and hold it in while you turn the radio on.

### Lamp adjust

Your radio has 10 brightness levels on the display. To adjust the brightness, press and hold **CALL-MENU** while the radio is idle. Select *System* and then *Lamp Adjust*. Use **CHANNEL UP** and **CHANNEL DOWN** to change the brightness to your desired level.

### Turning the key beep on and off

Key beep is the tone that sounds when you press a key or a button. To turn off the key beep, press and hold **CALL-MENU** while the radio is idle. Select *System* and then *Key Beep*. Choose *Off* to turn off the key beep.

## Setting the GPS position manually

You will see different display messages on your radio depending on what state your radio is in. Refer to the following table for a description of what displays according to what condition the radio is in. For example, if you turn on your radio and it is connected to a GPS unit but the GPS is not sending data, the radio displays *Check GPS*. At the 30 minute mark with no GPS data input from the GPS unit, the radio display changes to *Input Position*.

Timeframe	Is GPS Connected?	Display	Alert	Condition (Notes)
From power on to 30 minutes	Yes	<i>GPS OK</i>	None	Normal
	Yes	<i>Check GPS</i>	None	Error *
	No	None	None	Normal
At 30-minute mark after power on  <b>Note: If the radio receives GPS data by the 30-minute mark, the next level of displays apply</b>	Yes	<i>GPS OK</i>	None	Normal
	Yes	<i>Input Position</i>	Yes	Error * (continuous display)
	No	<i>Input Position</i>	Yes	Normal (continuous display)
<i>The radio receives correct GPS data either through manual input or GPS.</i>				
Up to 4 hours after receiving valid GPS data	Yes	<i>Check GPS</i>	None	Error
	No	None	None	Normal



Timeframe	Is GPS Connected?	Display	Alert	Condition (Notes)
At 4 hour mark after receiving valid GPS data	Yes	<i>Input Position</i>	Yes	Error * (continuous display)
	None	<i>Input Position</i>	None	Normal (continuous display)
Over 23.5 hours after receiving valid GPS data	Yes	<i>Input Position</i>	None	Error * (Lost GPS data; continuous display)
	None	<i>Input Position</i>	None	Normal (Lost GPS data; continuous display)

\* If the radio displays an error condition, the radio cannot receive valid GPS data; check the GPS

**NOTE:** Be certain any manually-entered position is correct. If you enter the wrong position and then make a DSC distress call, you will be telling the arrows to adjust each of the values in turn.

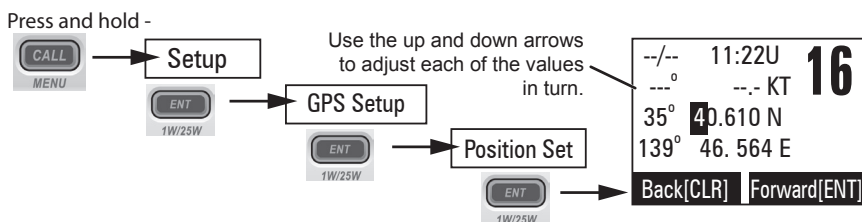

1. Display the normal menu and choose the *Setup* sub-menu.
2. Select *GPS Setup* and then choose *Position Set*.
3. The GPS manual input screen displays; the fields to be entered blink. The cursor highlights the hour. Use **CHANNEL UP** and **CHANNEL DOWN** to set the displayed hours to match coordinated universal time (UTC, also call Greenwich Mean Time and Zulu Time). When the display matches UTC time, press **ENT-1W/25W**. If you make a mistake while entering a digit, press **CLR-SCAN** to erase the wrong number and moved the cursor to the left digit.
4. The cursor moves to highlight the minutes. Use **CHANNEL UP** and **CHANNEL DOWN** to adjust the minutes and press **ENT-1W/25W**.
5. The cursor moves to highlight the degrees latitude. As you update each value, the cursor moves to the next value in turn. At each number, use **CHANNEL UP** and **CHANNEL DOWN** to adjust the number and press **ENT-1W/25W**.

When you have entered the last value, the radio returns to the *GPS Setup* menu.



## USING DIGITAL SELECTIVE CALLING (DSC) FEATURES

### What is DSC?

Digital Selective Calling (DSC) is a standard that allows you to call other stations using their unique identification code (the Maritime Mobile Service Identity or MMSI number), just like you would call a phone number. To call another station, just enter that station's MMSI number and choose the voice channel you want to talk on. The radio uses channel 70 to transmit your MMSI number to the other station along with the voice channel you requested. If the other station accepts your call, both radios automatically switch to the requested voice channel so you can talk to the other station.

DSC provides a system for automated distress calls. At the touch of a button, the radio can transmit your MMSI number, the nature of your distress, and your current position based on data from your GPS receiver. The radio repeats the distress call every few minutes until it receives an acknowledgement.

The DSC standard dedicates a VHF channel—channel 70—to digital transmissions only. Since digital transmissions require less bandwidth voice transmissions, channel 70 avoids the problems of busy voice channels.

### Advanced DSC features

Your radio supports the following DSC features:

Feature	Menu Item	Function
Individual Call	Individual	Contact another vessel from your directory.
Group Call	Group	Contact all vessels that share your group MMSI code.
All Ships Call	All Ships	Broadcast to all vessels within range (used for safety or advisory messages).
Position Request	POS Request	Request the current location of another vessel.
Position Send	Position Send	Transmit your current location to another vessel.
Test Call	Test	Make sure your radio is working and configured correctly.
Name and MMSI Directory	Directory	Store a list of 20 names and MMSI identification codes for DSC calls.
Standby Mode	Standby	Automatically respond to all DSC calls within an "Unavailable" status.
Received Call Log	Receive Log	Display the last 10 distress calls received by the radio and the last 20 general calls.

### What is an MMSI number?

In order to use DSC features, you must be assigned an MMSI number and program that number into your radio. There are two kinds of MMSI numbers: individual numbers for use by single boats and group numbers for use by fleets, boating organizations, event coordinators, etc.

You can get more information on MMSI numbers at these resources:

- The dealer where you purchased the radio
- Recreational boaters can obtain an MMSI number from the Boat Owner's Association of the U.S. (<http://www.boatus.com/mmsi/> or call 800-536-1536) or Sea Tow Services International ([http://seatow.com/boating\\_safety/mmsi.asp](http://seatow.com/boating_safety/mmsi.asp))
- Commercial boaters need a ship station license to get an MMSI number. For more information, visit the Federal Communications Commission (FCC) website at <http://wireless.fcc.gov/marine/fctsht14.html>.

## Entering MMSI numbers

### Individual or User MMSI Number

**NOTE:** Be sure you have the correct User MMSI number before entering it in the radio. The radio only allows you to enter the user MMSI once. If you need to re-enter the User MMSI number, contact customer service (see back page for contact information). Follow the steps below to enter your individual or user MMSI number into the radio:

Press and hold -

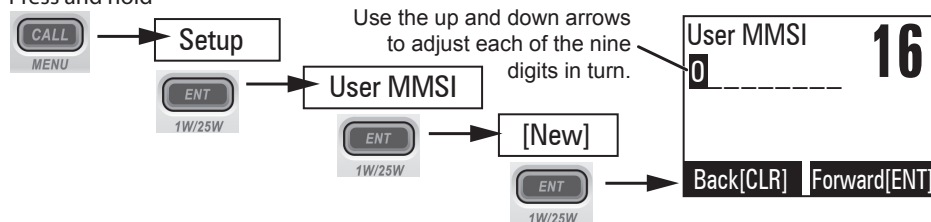

1. Display the normal menu and choose the *Setup* sub-menu.
  2. Select User MMSI. (If an MMSI number was already entered, the screen displays it with the message *Cannot change over 1 time*. Contact customer service. (See back page for contact information).)
  3. Use **CHANNEL UP** and **CHANNEL DOWN** to enter the first of the nine digits; **CHANNEL UP** increases the number and **CHANNEL DOWN** decreases it.
  4. When the first digit is correct, press **ENT-1W/25W**. The cursor moves to the next digit. Enter the remaining eight digits of the MMSI number in the same way. If you make a mistake while entering a number, press **CLR-SCAN** to erase the wrong number and the cursor is moved to the left digit.
  5. When the ninth digit is correct, press **ENT-1W/25W**. The radio displays the new MMSI number and asks you to confirm. To save this MMSI number, select *Yes*; the radio asks for confirmation again. To cancel this MMSI number, select *No*; the radio returns to the *Setup* menu.
- NOTE:** Be sure you entered the number correctly before confirming the entry. You can only save the user MMSI once.
6. Before saving the number, the radio displays a final confirmation screen and reminds you that this is a permanent setting. Press **ENT** to accept this MMSI. Press **CLR** to return to the *User MMSI Entry* screen

## Group MMSI number

You can change the group MMSI number as often as you want. Follow the steps below to enter a group MMSI number into the radio:

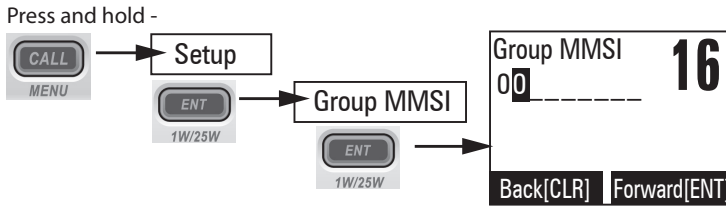

1. Display the normal menu and choose the *Setup* sub-menu.
2. Select *Group MMSI*. If one was entered previously, the screen displays it.
3. Group MMSI numbers always start with a 0, so that digit is already entered for you. Use **CHANNEL UP** and **CHANNEL DOWN** to change the second of the nine digits; **CHANNEL UP** increases the number and **CHANNEL DOWN** button decreases it.
4. When the second digit is correct, press the **ENT-1W/25W**. The cursor moves to the next digit. Enter the remaining seven digits of the MMSI number in the same way. If you make a mistake while entering a number, press **CLR-SCAN** to erase the wrong number and the cursor is moved to the left digit.
5. When the ninth digit is correct, press **ENT-1W/25W**. The radio displays the new MMSI number and asks you to confirm.
6. To save this MMSI number, select *Yes* and confirm the entry. To cancel this MMSI number, select *No*. The radio returns to the *Setup* menu.

## Using the Directory

The directory lets you store up to 20 MMSI numbers of other stations so you can call them quickly.

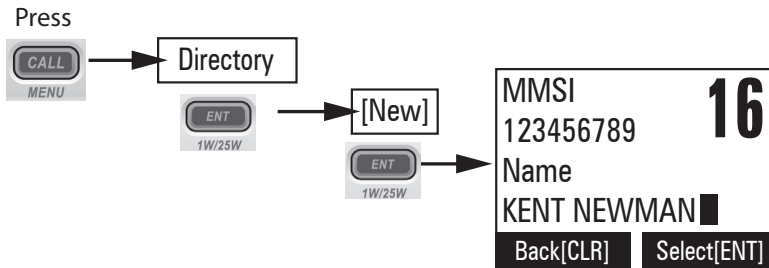

Follow the steps below to edit the MMSI numbers in your directory:

1. Press **CALL-MENU** to display the call menu.
2. Select *Directory*. The screen displays any previously-entered MMSI numbers and names.
3. To add a new MMSI number to the directory, select *New*.
4. The radio prompts you to enter the nine-digit MMSI number. Use **CHANNEL UP** and **CHANNEL DOWN** to change the first digit; the **CHANNEL UP** button increases the number and the **CHANNEL DOWN** button decreases it.





5. When the first digit is correct, press **ENT-1W/25W**. The cursor moves to the next digit. Enter the remaining eight digits of the MMSI number in the same way. If you make a mistake while entering a number, press **CLR-SCAN** to erase the wrong number and the cursor is moved to the left digit.
6. When the ninth digit is correct, press **ENT-1W/25W**.
7. The radio prompts you to enter a name for this MMSI number; the name is what you will see in the directory list. Each name can be up to 12 characters. Use **CHANNEL UP** and **CHANNEL DOWN** to change the first character. The channel buttons scroll through the available characters according to the following table:

Channel Up Button	Channel Down Button
Capital letters (A through Z)	One blank space
Lower-case letters (a through z)	Numbers (0 through 9)
Punctuation (/ ' + -)	Punctuation (/ ' + -)
Numbers (0 through 9)	Lower-case letters (a through z)
One blank space	Capital letters (A through Z)

8. When the first character is correct, press **ENT-1W/25W** button. The cursor moves to the next character. Enter the remaining 11 characters of the name. If the name is shorter than 12 characters, press and hold **ENT-1W/25W** to complete the name entry. (If you press and hold **ENT-1W/25W** without entering a name, the radio uses the MMSI number in the directory list.) If you make a mistake while entering a number, press **CLR-SCAN** to erase the wrong number and the cursor is moved to left digit.
9. When you finish entering the name, the radio displays the new MMSI number and name and asks you to confirm. To save this directory entry, select Yes; to cancel this directory entry, select No. The radio returns to the directory list.
10. To change an existing directory entry, select the entry you want to change.
11. To delete the directory entry, select *Delete*. To edit the code, select *Edit*, then use **CHANNEL UP** and **CHANNEL DOWN** to edit the MMSI number and the name.
12. When you are satisfied with the directory list, select *Exit* to close the menu screen.

## Making DSC Calls

There are essentially four different types of DSC voice calls:

Call type	What it does	When to use it
Distress	Alerts all stations that you need assistance and sends them your current position.	In an emergency only.
Individual	Calls a single station using the User MMSL.	Any time you want to talk to another station.
Group	Calls all the stations that have the same Group MMSL as yours.	Any time you want with the whole group you are traveling with at the same time.
All Ships	Calls all stations within range of your radio.	Safety warnings (e.g., debris in the water) or any urgent situation.





Suppose you are coordinating safety for a sailboat race. Before the race starts, you instruct all the racers to enter your group MMSI number into their radios. During the race:

- Throughout the race, you use group calling to update the racers on the time, race status, and any course corrections.
- A power boat full of spectators comes a little too close to the race path. You use individual calling to contact the power boat and advise them to stay clear of the race.
- You see a rowboat entering the area, but since it doesn't have a radio, you can't communicate with the rowboat. You use all ships calling to alert all the other boats in the area of the possible danger.

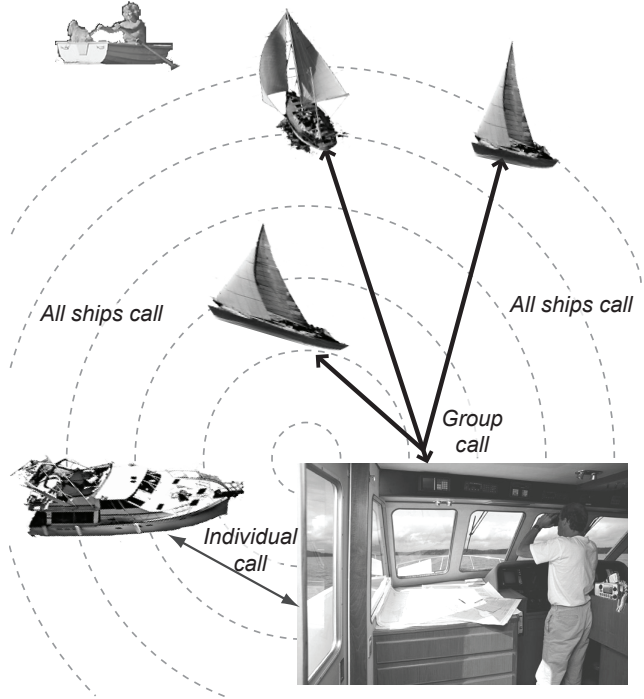

### Calling a single station (Individual Call)

To call a single station with DSC, follow the steps below:

1. Press **CALL-MENU** to display the call menu.
2. Select *Individual*.
3. The radio displays the names listed in your directory; use **CHANNEL UP** and **CHANNEL DOWN** to choose the directory entry you want to call and press **ENT-1W/25W**.  
If you want to call a station that is not in your directory, select *Manual*. The radio prompts you to enter the MMSI number you want to call. Enter the MMSI number the same way you enter directory entries (see page 19) Enter all nine digits and press **ENT-1W/25W**.
4. The radio prompts you to select a response channel. Use **CHANNEL UP** and **CHANNEL DOWN** to scroll through the available channels. When you reach the channel you want to use for a response, press the **ENT-1W/25W** button.
5. The radio displays the MMSI number you are about to call and asks you to confirm. If you want to call the displayed MMSI number, select *Send*. To cancel the call, select *Cancel*.
6. The radio automatically switches to channel 70 to transmit the call request.
  - When the other station accepts the call, both radios switch to the selected response channel for voice transmission.
  - If the other station cannot respond on the channel you selected, the radio displays *Not support CH*.





### Calling a particular group of stations (Group Call)

Group calling calls all the stations that share your group MMSI. You must have a group MMSI programmed into the radio to make a group call, and the stations (boats) you are calling must have this same group MMSI programmed into their radios.

1. Press **CALL-MENU** to display the call menu.
2. Select *Group*.
3. The radio prompts you to select a response channel. Use **CHANNEL UP** and **CHANNEL DOWN** to scroll through the available channels. When you reach the channel you want to use for a response, press **ENT-1W/25W**.
4. The radio asks you to confirm the call. Select *Send* to continue with the call or select *Cancel* to cancel the call.
5. The radio switches to channel 70 to transmit the call request then automatically switches to the designated response channel.

### Calling all stations (All-Ships Call)

All ships calling contacts all DSC radios within range of your boat. You should only use all ships calling in the event of a Safety warning (such as debris in the water) or to request assistance in an Urgency (any situation where your vessel has a serious problem but is not yet in distress).

1. Open the call menu.
2. Select *All Ships*, and then choose whether this is an Urgency call or a Safety call.
3. The radio asks you to confirm the call. Select *Send* to continue with the call or select *Cancel* to cancel the call.
4. The radio automatically switches to channel 70 to transmit the call request then automatically switches to channel 16, the designated response channel for all-ships calling.

### Making an automatic distress call

If you have programmed your MMSI number, your radio can transmit an automated distress call with your current location and nature of the distress. The radio then monitors the channel 16 for a response and repeats the distress call every few minutes until it receives an acknowledgement.

**To send an automatic distress call, press and hold DISTRESS for three seconds. If no MMSI number has been programmed, the radio prompts you to enter your MMSI number.**

If you want to include the nature of your distress in the distress call, use the following distress procedure:

1. Press **DISTRESS**.
2. The radio displays the list of distress conditions; use **CHANNEL UP** and **CHANNEL DOWN** to choose the nature of your distress, then press and hold **DISTRESS** for three seconds.

Undesignated	Sinking	Fire
Adrift	Flooding	Abandoning
Collision	Piracy.Armed	Grounding
Overboard	Capsizing	



- If no MMSI number has been programmed, the radio prompts you to enter your MMSI number.

### Canceling an automatic distress call

While the radio is waiting for a response, it gives you the option of canceling the call. To cancel the distress call, choose *Cancel* and press **ENT-1W/25W**.

### Receiving a DSC call

If your radio receives an individual DSC call from another station, it sounds an incoming call tone and displays the name or MMSI number of the station calling you. To respond to the call, select *Send: Able-Comply*; the radio sends an acknowledgement and automatically switches to the designated response channel. To reject the call, select *Send: Unable-Comply*; the radio advises the other station that you are unable to respond to the call.

If the DSC request contains a response channel that you are not allowed to use, the radio displays *Not Support CH*; your only response option is *Send: Unable-Comply*.

If the radio receives a group or all ships call, it sounds an incoming call tone and automatically switches to the designated response channel.

### Receive log

Just like your telephone's caller ID list, your radio keeps track of the calls you receive but do not answer. The receive log is useful if you have been off your boat or away from your radio and want to see who has tried to contact you. The radio displays the last 10 distress calls and the last 20 non-distress calls that it received. If you have unread incoming DSC calls, the radio displays a Message icon. When you display all Distress and Other receiving logs, the message icon disappears.

- Press **CALL-MENU** to display the call menu.
- Select *Receive Log*.
- Select *Distress* to see the last 10 distress call received by the radio. Select *Other* to see the last 20 normal calls received by the radio, then choose from *Individual*, *Group*, or *All Ships* calls.
- Calls are listed in the order they were received, with the newest call shown first. The display blinks if there are new calls you have not reviewed.
- Select the call you want to see the details of. Use **CHANNEL UP** and **CHANNEL DOWN** to see all of the information. The log displays different information depending on type of call received. See the table below for the information stored for each type of call:

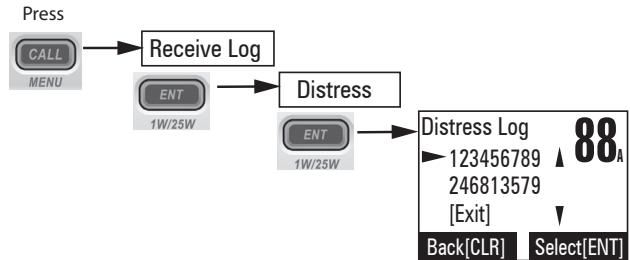

DSC Call Type	Receive Log Information
Distress	MMSI (or name), position, time, nature code.
Distress Acknowledge	MMSI (or name), distress MMSI, position, time, nature code.
Distress Relay	MMSI (or name), distress MMSI, position, time, nature code.



DSC Call Type	Receive Log Information
Distress Relay Acknowledge	MMSI (or name), distress MMSI, position, time, nature code.
Geographical	MMSI (or name), category code, communication channel number.
All Ships	MMSI (or name), category code, communication channel number.
Group	MMSI (or name), category code, communication channel number.
Individual	MMSI (or name), category code, communication channel number.
Individual Acknowledge	MMSI (or name), Completed/Unattended, category code, communication channel number.
Test	MMSI (or name), category code.
Test Acknowledge	MMSI (or name), category code.
Pos Reply	MMSI (or name), position, time, category code.
Pos Request	MMSI (or name), category code.
Pos Send	MMSI (or name), position, time, category code,

6. Press **CLR-SCAN** button to exit the detail screen and return to the log menu.
7. From the log menu, select *Exit* to close the receive log and return to your previous mode.

### Returning a call

You can return individual calls directly from the receive log. From the call detail screen, press **CHANNEL DOWN** until *Call Back* appears at the bottom of the display. Press **ENT-1W/25W** to return that station's call.

## Test Calls

### Making Test Calls (Test)

You can use the test call feature to make sure your radio is working and configured correctly. To avoid overloading coastal receiving stations, you should limit test calls to these stations to once a week.

**NOTE:** Many coastal stations have specific frequencies and MMSI numbers you should use for making test calls. Before making a test call to a coastal station, be sure to check the **Local Notice to Mariners (LNM)**, issued every week by the US Coast Guard. The LNMs for each region are available online at <http://www.navcen.uscg.gov/lnm/default.htm>.

1. Press **CALL-MENU** to display the call menu.
2. Select *Test*.
3. The radio displays the names listed in your directory; use **CHANNEL UP** and **CHANNEL DOWN** to choose the directory entry you want to send a test call to and press **ENT-1W/25W** button.

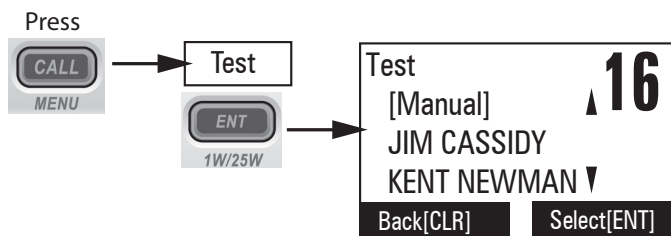

If you want to send a test call to a station that is not in your directory, select *Manual*. The radio prompts you to enter the MMSI number you want to call. Enter the MMSI number the same way you enter directory entries (see page 19). Enter all nine digits and press **ENT-1W/25W** button.

4. The radio displays the MMSI number you are about to call and asks you to confirm. If you want to call the displayed number, select *Send*. To cancel the call, select *Cancel*.
5. The radio automatically switches to channel 70 to transmit the test call request, then switches back to the last-used channel.
6. When the other station acknowledges the test call, the radio displays an acknowledgement screen.

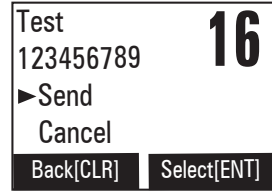

### Receiving Test Calls

When another station sends you a test call, the radio displays the test request screen.

To acknowledge the test call, select *Reply*.  
To reject the test call, select *Cancel*.

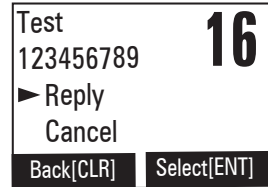

### Enabling automatic test call reply

If you want the radio to automatically reply to all test calls, you can enable automatic test call reply.

1. Press and hold **CALL-MENU** to display the normal menu.
2. Select *Setup* and then *Test Reply*.
3. Choose *Auto* and press **ENT-1W/25W**. The radio will automatically send an acknowledgement when it receives a test call.

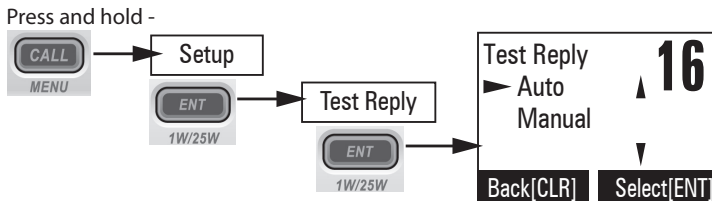

4. To disable automatic test call reply, repeat the steps above and select *Manual*.



## Position Request and Reply

### Requesting another station's position (POS Request)

Anytime you need to know where another boat currently is—to find your boating partners, to respond to a request for assistance, etc.—you can send a position request to their radio:

1. Press **CALL-MENU** to display the call menu.
2. Select *DSC Call* sub-menu, then select *POS Request*.
3. The radio displays the names listed in your directory; use **CHANNEL UP** and **CHANNEL DOWN** to choose the directory entry you want to contact and press **ENT-1W/25W**. If you want to contact a station that is not in your directory, select *Manual*. The radio prompts you to enter the MMSI number you want to call. Enter the MMSI number the same way you enter directory entries (see page 19). Enter all nine digits and press **ENT-1W/25W**.
4. The radio displays the MMSI number you are about to contact and asks you to confirm. If you want to request the position of the displayed MMSI number, select *Send*. To cancel the request, select *Cancel*.
5. When the other station responds, the radio displays the MMSI number, the longitude, and the latitude of the other station. If your radio is connected to a chartplotter through the NMEA OUT connection (see page 31), the position information will also be displayed on the plotter screen.
6. If the other station does not have valid GPS data, the radio displays *No Position*.

### Receiving a position request (Position Reply)

When another station requests your current position, the radio displays the following screen:

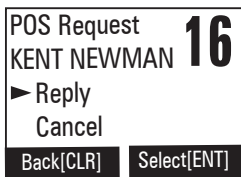

To send your current position to the other station, select *Reply*; the radio transmits your latitude and longitude to the other station. If you select *Reply* but the radio does not have valid GPS data, it transmits the reply code with *No Position*.

To reject the position request, select *Cancel*.

### Enabling automatic position reply

If you want the radio to automatically transmit your current position whenever it receives a position request, you can enable automatic position reply. Most boaters activate automatic position reply for safety reasons or because they subscribe to a marine towing service. Sometimes—for example, in some competitive situations—you may not want other stations to get your position without your manual confirmation

1. Press and hold **CALL-MENU** to display the normal menu.
2. Select *Setup* and then *POS Reply*.
3. Choose *Auto* and press **ENT-1W/25W**. The radio will automatically transmit your position when it receives a position request.



4. To disable automatic position reply, repeat the steps above and select *Manual*.

### **Sending your own position (Position Send)**

If your radio is connected to a GPS receiver, you can send your boat's position to someone else. If you are requesting assistance or using an all ships call to give a safety warning, you can send your current position so other stations know where you are:

1. Press **CALL-MENU** to display the call menu.
2. Select *Position Send*.
3. The radio displays the names listed in your directory; use **CHANNEL UP** and **CHANNEL DOWN** to choose the directory entry you want to contact and press **ENT-1W/25W**. If you want to contact a station that is not in your directory, select *Manual*. The radio prompts you to enter the MMSI number you want to call. Enter the MMSI number the same way you enter directory entries (see page 19). Enter all nine digits and press **ENT-1W/25W**.
4. The radio displays the MMSI number you are about to contact and asks you to confirm. If you want to transmit your position to the displayed MMSI number, select *Send*. To cancel the transmission, select *Cancel*.
5. The radio transmits your MMSI number, your longitude, and your latitude to the other station.

### **Putting the radio into standby**

If you are leaving your radio or do not wish to answer any DSC calls, you can put your radio in standby mode. If your radio receives an individual call, it will automatically respond with a message that indicates your radio is currently unattended. Follow the steps below to put your radio in standby:

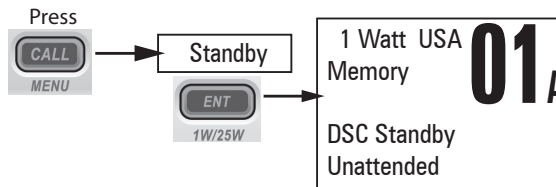

1. Display the *Call* menu.
2. Select *Standby* to place your radio in standby mode. The radio displays the standby screen, above.
3. To cancel standby and return to the mode your radio was in, press any button.

### **Disabling automatic channel switching**

If you are involved in a bridge-to-bridge call, you may not want the radio to automatically switch channels when it receives a DSC call. In cases like this, you can disable automatic channel switching. If you receive an individual call, the radio will respond with an unattended code, just as if the radio were in Standby.

1. Press and hold **CALL-MENU** to display the normal menu.
2. Select *Setup* and then *Auto CH SW*.
3. Choose *Off* and press **ENT-1W/25W**. The radio will not automatically switch channels until you reactivate this feature.



**NOTE:** Use this feature with caution. Deactivating automatic switching and then forgetting it can make it hard for you to receive DSC calls.

If you have unread incoming DSC calls, the radio displays a message icon. You will be able to review who has called. The radio displays the last 10 distress calls and the last 20 non-distress calls it received (see the receive log on page 24).

## INSTALLING THE HARDWARE

### Mounting the radio

Your radio can sit at any angle in the mounting bracket so it can easily accommodate the best location. First, determine the best place to mount the radio. For optimum performance, find a location that can:

- Properly support the weight of the radio, approximately 2.2 pounds or 1.0 kilograms. You may need to use some type of anchor with the mounting screws to hold the radio, depending on the surface.
- Keep the battery leads as short as possible.
- Keep the antenna lead-in wire as short as possible.
- Allow free air flow around the heat sink on the rear of the radio.
- Avoid interference with the ship's compass.

1. Install the radio into the mounting bracket.

2. Position the radio into the desired location. Mark the edges of the bracket on the mounting surface.

3. Remove the mounting bracket drill template from the back of the manual, and use the template to mark the drill holes on the mounting surface.

4. Drill the holes for the mounting bracket; be sure to follow any special requirements of the mounting surface.

5. Remove the bracket from the radio, and use the mounting hardware to secure the bracket to the mounting surface.

6. Install the radio back into the mounting bracket.

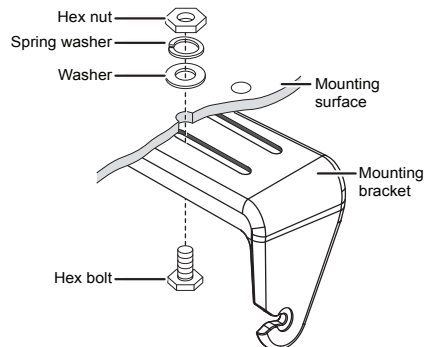
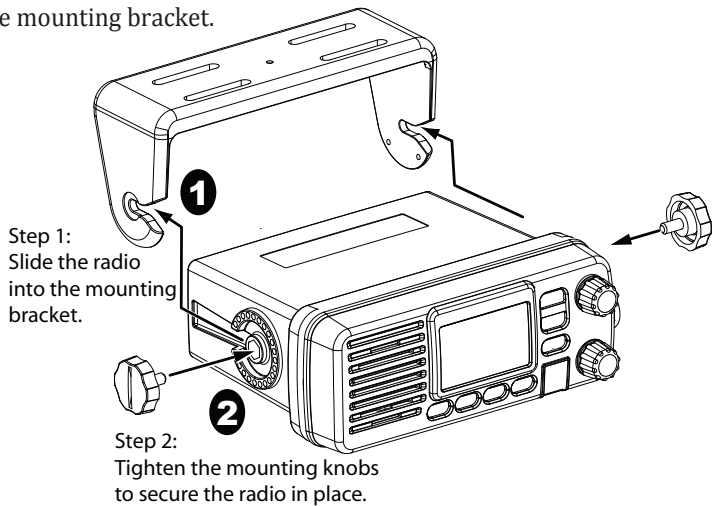

## Connecting the radio

To operate correctly, your radio requires two electrical connections:

- providing it with power from the boat's electrical system
- connecting a VHF-FM marine antenna to the antenna connector

Power Supply Requirements	VHF Antenna Requirements
Nominal 13.8 VDC power supply with a negative ground (9.5 VDC to 15.8 VDC). Power leads should be kept as short as possible. A direct connection to the power supply is ideal. Minimum of #14 AWG copper wire for extensions up to 20 feet, 12 AWG wire for extensions from 20 to 35 feet, or 10 AWG wire for extensions from 35 to 60 feet.	Male PL-259 connector 50 $\Omega$ impedance Minimum 4 foot, 3 dB rated antenna for sailboats or 8 foot, 6dB rated antenna for powerboats Minimum RG-58 lead-in wire for antenna leads up to 20 feet, RG-8X for antenna leads from 20 to 35 feet, or RG-8U for antenna leads from 35 to 60 feet.

1. Connect the BLACK wire of the power cable to the NEGATIVE (-) side of your power source.
2. Connect the RED wire of the power cable to the POSITIVE (+) side of your power source.
3. NOTE: To extend the life of the radio, use waterproof tape to seal electrical connections.
4. Install your antenna according to the manufacturer's instructions.
5. If necessary, consult the FCC guidelines for antenna separation. See Antenna Selection and Installation on page 47 for more details. (In summary, the FCC recommends that antennas up to 3 dB be installed a minimum of 3 feet from any occupied location; antennas over 3 dB should be installed at least 6 feet away.)
6. Connect the PL-259 connector from the antenna lead-in wires to the SO238 connector labeled **ANTENNA** on the back of your radio.

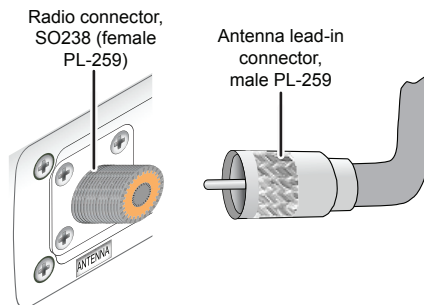
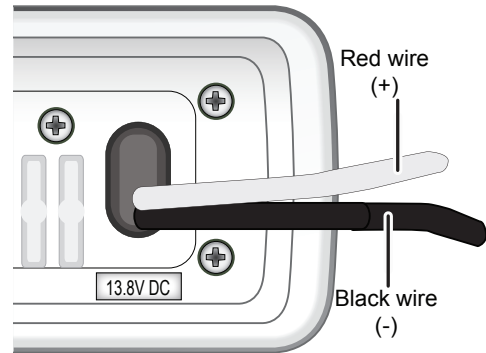

## Connecting to a GPS receiver

If you connect the radio to a GPS receiver, the radio can automatically transmit your current position during an automated distress call or during a normal DSC call.

Your radio supports a standard NMEA0183 input from a GPS receiver. Follow the steps below to connect your radio to your GPS receiver:

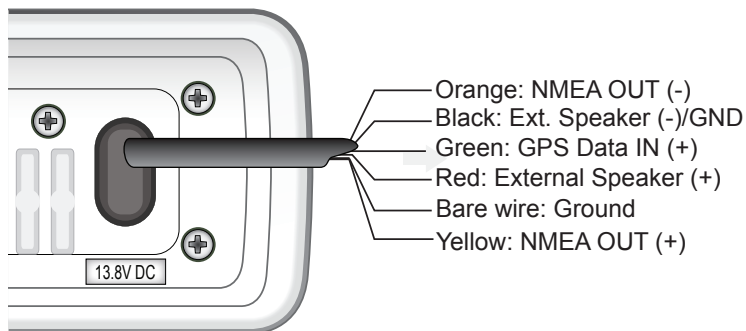

1. Connect the BARE wire of the included accessory cable to the GROUND WIRE on your GPS receiver.
2. Connect the GREEN wire of the included accessory cable to the GPS DATA OUTPUT WIRE on your GPS receiver. Below is a table of common GPS receivers and the proper connections:

GPS Manufacturer	Model Number(s)	GPS NMEA0183 OUTPUT Wire Color (Connect to GREEN WIRE on your radio)	Ground Wire Color (connect to BARE WIRE on your radio)
Furuno	GP1650, GP1850	White	Black
Furuno	GP30, GP36	White	Blue
Garmin	Fixed Mount Models	Blue	Black
Garmin	Portable Models	Brown	Black
JRC	100 Series	Green	Black
JRC	200 Series	White	Black
JRC	GPS500	Yellow	Green
Lowrance / Eagle	Fixed Mount Models	White	Black
Lowrance / Eagle	Portable Models	Orange	Black
Magellan	Fixed Mount Models	Gray	Black
Magellan	Portable Models	Orange	Black



GPS Manufacturer	Model Number(s)	GPS NMEA0183 OUTPUT Wire Color (Connect to GREEN WIRE on your radio)	Ground Wire Color (connect to BARE WIRE on your radio)
Northstar	All Models	Yellow	Black
RayMarine	420	Yellow	Brown
RayMarine	520 / 620	Blue	Brown
RayMarine	RL Series	White	Brown
Simrad	All Models	White	Brown
Sitex	Neptune, Nautilus	Gray	Brown
Standard	CP150 / CP150C	Green	Yellow

3. Be certain all wire connections are secure and that all open wires are adequately covered.

**NOTE:** To extend the life of the radio, use waterproof tape to seal electrical connections.

#### GPS Verification

If the GPS receiver is correctly connected and it transmits valid data, the display shows *GPS Data OK*. Press **ENT-1W25W** to open the GPS status screen and see detailed GPS data:

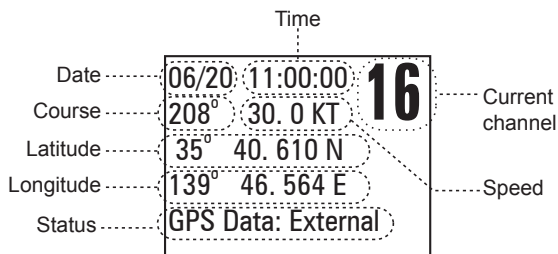

If the GPS does not send coordinates within 30 minutes, an audible alert sounds once and the display shows *Input Position*. This message remains until the coordinates are updated.

After 4 hours, the audible alert sounds again if no coordinates are received and the GPS is connected. After 23.5 hours, the radio deleted the current coordinates and displays *Input Position*.

See page 16 to manually set the GPS coordinates.

#### Configuring the GPS

If the radio is receiving valid GPS data, it will automatically set the clock to your local time based on the GPS location. You can adjust your local time forward or back one hour if necessary (for example, if you are close to the border of a time zone); you can also adjust for Daylight Savings Time.



Follow the steps below to adjust the time:

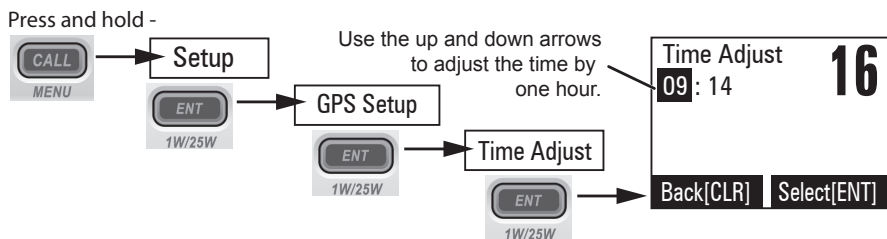

1. Display the normal menu and choose the *Setup* sub-menu.
2. Select *GPS Setup* and then choose *Time Adjust*.
3. The display shows your current local time. To adjust the time forward one hour, use **CHANNEL UP**. To adjust the time back one hour, use **CHANNEL DOWN** button. Press **ENT-1W/25W** button when you are finished.
4. The display prompts you to confirm the setting: choose *Set* to save the new time or *Cancel* to exit time setup without saving. The radio returns to the *GPS Setup* menu.
5. If your local area observes Daylight Savings Time, choose *Daylight Save* and press the **ENT-1W/25W** button.
6. If Daylight Savings Time is currently in effect, select *On*. If Daylight Savings Time is not currently in effect, select *Off*.
7. Press **ENT-1W/25W**. The radio activates the new time setting and returns to the *GPS Setup* menu.

## Connecting to a Chartplotter

Your radio provides a standard NMEA0183 GPS output that you can connect to a chartplotter. When it receives another boat's position data in a DSC call, the radio sends the position data to the chartplotter so you can see the location:

1. Connect the **ORANGE** wire of the accessory cable to the **NEGATIVE (-)** wire of your chartplotter's NMEA data INPUT.
2. Connect the **YELLOW** wire of the accessory cable to the **POSITIVE (+)** wire of your chartplotter's NMEA data INPUT
3. Be certain all wire connections are secure and that all open wires are adequately covered.

**NOTE:** To extend the life of the radio, use waterproof tape to seal electrical connections.

## Connecting to an External Speaker

You can use an external speaker to monitor the radio from a different part of your boat or in a noisy environment. If you adjust the **VOLUME-PWR** knob on the radio, it will also adjust the external speaker volume.

Your radio supports an external speaker with the following specifications:

- Minimum impedance of 4 Ohms
  - Minimum power handling of 10 Watts
1. Connect the **BLACK** wire of the accessory cable to the **GROUND WIRE** of your external speaker.

2. Connect the RED wire of the accessory cable to the POSITIVE (+) WIRE of your external speaker.
3. Be certain all wire connections are secure and that all open wires are adequately covered.

 **NOTE:** To extend the life of the radio, use waterproof tape to seal electrical connections.

## MAINTENANCE AND TROUBLESHOOTING

Due to its rugged design, your radio requires very little maintenance. However, it is a precision electronic instrument, so you should follow a few precautions:

- If the antenna has been damaged, you should not transmit except in the case of an emergency. A defective antenna may cause damage to your radio.
- You are responsible for continued FCC technical compliance of your radio.
- You should arrange for periodic performance checks with your dealer.

Problem	Things to Try
The radio won't power on.	Check the power connections. Check the fuse. Check the master battery switch and branch circuit that connect to the radio.
The radio won't transmit.	Make sure you are not in weather or scan mode. Make sure you are not trying to transmit on a receive-only channel (see the channels and frequency tables beginning on page 37). Make sure you are transmitting at the correct power level for this channel (see the channels and frequency tables beginning on page 37). Make sure the duration of each transmission is less than 5 minutes.
Noise comes out of the speaker all the time	Adjust the squelch level; it is probably too low.
I can't hear anything (no volume) from the speaker.	Adjust the squelch level; it is probably too high.
I can transmit, but no one can hear me.	Check your UIC channel settings (see Setting the UIC channel mode ( <i>USA/CAN/INT</i> ) on page 6).
The display flashes, and I don't know why.	The display will flash if the radio is in a watch mode or in scan mode. Try turning off scanning, Weather Alert Watch, or Triple/Dual Watch (see page 6.)
I can't read the display.	Adjust the contrast and backlight brightness level (see page 16)
The display is too bright at night.	Adjust the backlight brightness level. Turn off the radio; hold CALL-MENU button and turn it back on (see page 16)



Problem	Things to Try
I can't see any words on the display.	Reset the radio back to the default brightness level: turn off the radio; hold the CALL-MENU button and turn it back on.
I'm not getting any GPS data on my display.	Make sure your GPS receiver is correctly connected (see Connecting to a GPS receiver, page 31). Make sure your GPS receiver is working properly. Make sure that your GPS receiver supports the NMEA parameters described in NMEA Operation on page 46.
I'm not getting any hazard alerts.	Make sure Weather Alert Watch is turned on. Check to make sure the FIPS codes in your radio include your current location (see Using FIPS codes for weather alerts on page 15).
I'm getting all the hazard alerts, not just the ones for my area.	Check to make sure the FIPS codes in your radio were entered correctly (see Using FIPS codes for weather alerts on page 15). Sometimes the Weather Alert Watch may catch a hazard alert in the middle of the broadcast and miss which FIPS codes are affected. For your safety, the radio triggers the alert tone and switches to the weather channel when this happens.
I can't make Group DSC calls.	Make sure the Group MMSI was entered correctly.
Where can I find my radio's serial number?	Look on the right side of the radio (the side with the microphone cord), behind the mounting bracket.
The radio won't let me enter my User MMSI. What do I do?	Contact customer service.

## Engine Noise Suppression

Interference from the noise generated by the electrical systems of engines is sometimes a problem with radios. Your radio has been designed to be essentially impervious to ignition noise and alternator noise. However, in some installations it may be necessary to take measures to further reduce the effect of noise interference. Your radio's DC battery wires, antenna lead, and accessory cables should be routed away from the engine and engine compartment, and from power cabling carrying high currents. In severe cases of noise interference, it may be necessary to install a noise suppression kit. Contact the dealer where you purchased the radio for more information.



## SPECIFICATIONS

All specifications are subject to change without notice.

### Radio Specifications

General	
Controls	Volume-Pwr, Squelch
Status Indicators	Transmit power, Scan mode, Triple Watch mode, Battery High, Battery low, USA, CAN, INT, Alert, Memory, GPS, Message, Weather band, GPS status and Channel Display
Display	LCD (Full Dot Matrix)
Buttons	ENT-1W/25W, Channel UP, Channel DOWN, CALL-MENU, WX-MEM, CLR-SCAN, 16/9-TRI, and DISTRESS
Connectors and Cables	Antenna, accessory, and DC power
Size	H 66 mm x W 162 mm x L 128 mm (without Heat Sink) H 2.95 inches x W 6.58 inches x L 5.08 inches
Weight	1.0 kg (2.2 pounds)
Supply Voltage	Nominal 13.8V DC, negative ground (9.5 VDC to 15.8 VDC)
Standard Accessories	Mounting bracket and hardware, microphone hanger,
Antenna Impedance	50 $\Omega$ nominal
Microphone	Rugged 2 k $\Omega$ condenser mic element with coiled cord
Speaker	1.77 inch, 8 $\Omega$
Operating Temperature Range	-20 °C to + 50 °C (-4 °F to +122 °F)
Shock and Vibration	Meets or exceeds EIA standards, RS152B and RS204C
FCC Approvals	Type accepted under part 80 of the Rules; meets Great Lakes Agreement and party boat requirements
Transmitter	
Power Output	1 watt or 25 watt (user selectable)
Power Requirement	25 watts output: 6A@13.8V DC
Modulation	$\pm$ 5 kHz deviation
Hum and Noise Signal-to-Noise	45 dB@1 kHz with 3 kHz deviation with 1000 Hz modulating frequency (nominal)
Audio Distortion	Less than 8% with 3 kHz deviation with 1000 Hz modulating frequency
Spurious Suppression	-40 dBm @ Hi, -40 dBm @ Lo
Output Power Stabilization	Built-in automatic level control (ALC)





<b>General</b>	
Frequency Range	156 to 158 MHz
Frequency Stability	±10 ppm @ -20°C to + 50°C
<b>Receiver</b>	
Frequency Range	156 to 163 MHz
Sensitivity	0.25 µV for 12 dB SINAD (nominal)
Circuit	Dual Conversion Super Heterodyne PLL (Crystal for DSC)
Squelch Sensitivity	0.2 µV Threshold
Spurious Response	75 dB (nominal)
Adjacent Channel Selectivity	70 dB @ ±25 kHz (nominal)
Audio Output Power	2.5 watts (10% Distortion, 8 Ω load)
Power Requirement	340 mA (nominal) @ 13.8V DC at squelched, 840 mA (nominal) @ 13.8V DC at maximum audio output
IF Frequencies	1st 41.925 MHz, 2nd 455 kHz (1st 21.7 MHz, 2nd 455 kHz for DSC)

## REFERENCE TABLES

 This radio does not support AIS channels.

### Channel descriptions and what they mean

The table below lists the display name or channel description used in the following tables and what each description means.

Channel name/description	Used for:
DISTRESS SAFETY AND CALLING	primarily emergency messages and distress calls
INTERSHIP SAFETY	safety messages from one ship to another, or from a ship to Coast Guard aircraft
NON-COMMERCIAL (recreational or voluntary ships only)	messages about the needs of the ship, including fishing reports, rendezvous, scheduling repairs and berthing information
COMMERCIAL (working ships only)	messages about the needs of the ship or the business the ship is engaged in
PUBLIC CORRESPONDENCE/ MARINE OPERATOR	calls to the marine operator at a public coast station. Marine operators can connect you to the telephone network so you can make and receive calls. (There is usually a charge for this service.)





Channel name/description	Used for:
PORT OPERATIONS/VTS (vessel traffic system)	messages about the movement and safety of ships in or near ports, locks or waterways. In certain major ports, some channels may be restricted to specific types of port operations messages.
NAVIGATIONAL/BRIDGE TO BRIDGE	messages about ship navigation, for example, passing or meeting other ships, maneuvering through locks, or navigating around drawbridges. Messages must be short!
STATE CONTROL	messages about government regulation and control, boating activities, or assistance to ships; also used to talk to ships and coast stations operated by state or local governments
DIGITAL SELECTIVE CALLING	DSC signals only (no voice communications allowed at any time)

## US Marine Channels and Frequencies

Ch No.	RX Freq	TX Freq	Status	Name on display
1A*	156.0500	156.0500	Simplex	Vessel traffic system/ Commercial
5A	156.2500	156.2500	Simplex	Vessel traffic system/ Commercial
6	156.3000	156.3000	Simplex	Inter-ship safety
7A	156.3500	156.3500	Simplex	Commercial
8	156.4000	156.4000	Simplex	Commercial
9	156.4500	156.4500	Simplex	Non commercial
10	156.5000	156.5000	Simplex	Commercial
11	156.5500	156.5500	Simplex	Vessel traffic system
12	156.6000	156.6000	Simplex	Vessel traffic system
13	156.6500	156.6500	Simplex, 1W	Bridge to bridge
14	156.7000	156.7000	Simplex	Vessel traffic system
15	156.7500	Inhibit	Receive Only	Environmental
16	156.8000	156.8000	Simplex	Distress, Safety, Calling
17	156.8500	156.8500	Simplex, 1W	Govt maritime control
18A	156.9000	156.9000	Simplex	Commercial
19A	156.9500	156.9500	Simplex	Commercial
20	161.6000	157.0000	Duplex	Port operation
20A	157.0000	157.0000	Simplex	Port operation
21A	157.0500	157.0500	Simplex	Coast guard only
22A	157.1000	157.1000	Simplex	Coast guard
23A	157.1500	157.1500	Simplex	Coast guard only





Ch No.	RX Freq	TX Freq	Status	Name on display
24	161.8000	157.2000	Duplex	Marine operator
25	161.8500	157.2500	Duplex	Marine operator
26	161.9000	157.3000	Duplex	Marine operator
27	161.9500	157.3500	Duplex	Marine operator
28	162.0000	157.4000	Duplex	Marine operator
63A	156.1750	156.1750	Simplex	Vessel traffic system
65A	156.2750	156.2750	Simplex	Port operation
66A	156.3250	156.3250	Simplex	Port operation
67	156.3750	156.3750	Simplex, 1W	Bridge to bridge
68	156.4250	156.4250	Simplex	Non commercial
69	156.4750	156.4750	Simplex	Non commercial
70	(156.5250	156.5250)	DSC Only	DSC
71	156.5750	156.5750	Simplex	Non commercial
72	156.6250	156.6250	Simplex	Non commercial (ship-ship)
73	156.6750	156.6750	Simplex	Port operation
74	156.7250	156.7250	Simplex	Port operation
75	156.775	156.7750	Simplex, 1W	Port operation
76	156.825	156.8250	Simplex, 1W	Port operation
77	156.8750	156.8750	Simplex, 1W	Port operation (ship-ship)
78A	156.9250	156.9250	Simplex	Non commercial
79A	156.9750	156.9750	Simplex	Commercial
80A	157.0250	157.0250	Simplex	Commercial
81A	157.0750	157.0750	Simplex	Government
82A	157.1250	157.1250	Simplex	Government
83A	157.1750	157.1750	Simplex	Coast guard
84	161.8250	157.2250	Duplex	Marine operator
85	161.8750	157.2750	Duplex	Marine operator
86	161.9250	157.3250	Duplex	Marine operator
87**	157.3750	157.3750	Simplex	Marine operator
88**	157.4250	157.4250	Simplex	Commercial (ship-ship)

\*A indicates simplex use of the ship station transmit side of an international duplex channel, and that operations are different from that of international operations on that channel.  
 \*\*Channels 87 & 88 revert from duplex to simplex operation. AIS channels are not supported.

### Canadian Marine Channels and Frequencies

Ch No.	RX Freq	TX Freq	Status	Name on display
1	160.6500	156.0500	Duplex	Marine operator
2	160.7000	156.1000	Duplex	Marine operator





Ch No.	RX Freq	TX Freq	Status	Name on display
3	160.7500	156.1500	Duplex	Marine operator
4A	156.2000	156.2000	Simplex	Canadian coast guard
5A	156.2500	156.2500	Simplex	Vessel traffic system
6	156.3000	156.3000	Simplex	Inter-ship safety
7A	156.3500	156.3500	Simplex	Commercial
8	156.4000	156.4000	Simplex	Commercial
9	156.4500	156.4500	Simplex	Boater calling channel
10	156.5000	156.5000	Simplex	Commercial
11	156.5500	156.5500	Simplex	Vessel traffic system
12	156.6000	156.6000	Simplex	Vessel traffic system
13	156.6500	156.6500	Simplex, 1W	Bridge to bridge
14	156.7000	156.7000	Simplex	Vessel traffic system
15	156.7500	156.7500	Simplex, 1W	Environmental
16	156.8000	156.8000	Simplex	Distress, Safety, Calling
17	156.8500	156.8500	Simplex, 1W	State control
18A	156.9000	156.9000	Simplex	Commercial
19A	156.9500	156.9500	Simplex	Canadian coast guard
20	161.6000	157.0000	Duplex, 1W	Port operation
21A	157.0500	157.0500	Simplex	Canadian coast guard
22A	157.1000	157.1000	Simplex	Canadian coast guard
23	161.7500	157.1500	Duplex	Marine operator
24	161.8000	157.2000	Duplex	Marine operator
25	161.8500	157.2500	Duplex	Marine operator
26	161.9000	157.3000	Duplex	Marine operator
27	161.9500	157.3500	Duplex	Marine operator
28	162.0000	157.4000	Duplex	Marine operator
60	160.6250	156.0250	Duplex	Marine operator
61A	156.0750	156.0750	Simplex	Canadian coast guard
62A	156.1250	156.1250	Simplex	Canadian coast guard
63A	156.1750	156.1750	Simplex	Port operation
64	160.8250	156.2250	Duplex	Marine operator
64A	156.2250	156.2250	Simplex	Port operation
65A	156.2750	156.2750	Simplex	Port operation
66A	156.3250	156.3250	Simplex, 1W	Port operation
67	156.3750	156.3750	Simplex	Bridge to bridge
68	156.4250	156.4250	Simplex	Non commercial
69	156.4750	156.4750	Simplex	Non commercial
70	(156.5250	156.5250)	DSC Only	DSC





Ch No.	RX Freq	TX Freq	Status	Name on display
71	156.5750	156.5750	Simplex	Non commercial
72	156.6250	156.6250	Simplex	Non commercial
73	156.6750	156.6750	Simplex	Port operation
74	156.7250	156.7250	Simplex	Port operation
75	156.7750	156.7750	Simplex, 1W	Port operation
76	156.8250	156.8250	Simplex, 1W	Port operation
77	156.8750	156.8750	Simplex, 1W	Port operation
78A	156.9250	156.9250	Simplex	Inter ship
79A	156.9750	156.9750	Simplex	Inter ship
80A	157.0250	157.0250	Simplex	Inter ship
81A	157.0750	157.0750	Simplex	Canadian coast guard
82A	157.1250	157.1250	Simplex	Canadian coast guard
83	161.7750	157.1750	Duplex	Canadian coast guard
83A	157.1750	157.1750	Simplex	Canadian coast guard
84	161.8250	157.2250	Duplex	Marine operator
85	161.8750	157.2750	Duplex	Marine operator
86	161.9250	157.3250	Duplex	Marine operator
87	157.3750	157.3750	Simplex	Port operation
88	157.4250	157.4250	Simplex	Port operation

## International Marine Channels and Frequencies

Ch No.	RX Freq	TX Freq	Status	Name on display
1	160.6500	156.0500	Duplex	Marine operator
2	160.7000	156.1000	Duplex	Marine operator
3	160.7500	156.1500	Duplex	Marine operator
4	160.8000	156.2000	Duplex	Marine operator
5	160.8500	156.2500	Duplex	Marine operator
6	156.3000	156.3000	Simplex	Inter-ship safety
7	160.9500	156.3500	Duplex	Marine operator
8	156.4000	156.4000	Simplex	Commercial (ship-ship)
9	156.4500	156.4500	Simplex	Boater calling channel
10	156.5000	156.5000	Simplex	Commercial
11	156.5500	156.5500	Simplex	Vessel traffic system
12	156.6000	156.6000	Simplex	Vessel traffic system
13	156.6500	156.6500	Simplex	Bridge to bridge
14	156.7000	156.7000	Simplex	Vessel traffic system
15	156.7500	156.7500	Simplex, 1W	Environmental





Ch No.	RX Freq	TX Freq	Status	Name on display
16	156.8000	156.8000	Simplex	Distress, Safety, Calling
17	156.8500	156.8500	Simplex, 1W	Govt maritime control
18	161.5000	156.9000	Duplex	Port operation
19	161.5500	156.9500	Duplex	Commercial
20	161.6000	157.0000	Duplex	Port operation
21	161.6500	157.0500	Duplex	Port operation
22	161.7000	157.1000	Duplex	Port operation
23	161.7500	157.1500	Duplex	Marine operator
24	161.8000	157.2000	Duplex	Marine operator
25	161.8500	157.2500	Duplex	Marine operator
26	161.9000	157.3000	Duplex	Marine operator
27	161.9500	157.3500	Duplex	Marine operator
28	162.0000	157.4000	Duplex	Marine operator
60	160.6250	156.0250	Duplex	Marine operator
61	160.6750	156.0750	Duplex	Marine operator
62	160.7250	156.1250	Duplex	Marine operator
63	160.7750	156.1750	Duplex	Marine operator
64	160.8250	156.2250	Duplex	Marine operator
65	160.8750	156.2750	Duplex	Marine operator
66	160.9250	156.3250	Duplex	Marine operator
67	156.3750	156.3750	Simplex	Bridge to bridge
68	156.4250	156.4250	Simplex	Non commercial
69	156.4750	156.4750	Simplex	Non commercial
70	(156.5250)	(156.5250)	DSC Only	DSC
71	156.5750	156.5750	Simplex	Non commercial
72	156.6250	156.6250	Simplex	Non commercial
73	156.6750	156.6750	Simplex	Port operation
74	156.7250	156.7250	Simplex	Port operation
75	156.7750	156.7750	Simplex, 1W	Port operation
76	156.8250	156.8250	Simplex, 1W	Port operation
77	156.8750	156.8750	Simplex	Port operation (ship-ship)
78	161.5250	156.9250	Duplex	Port operation
79	161.5750	156.9750	Duplex	Port operation
80	161.6250	157.0250	Duplex	Port operation
81	161.6750	157.0750	Duplex	Port operation
82	161.7250	157.1250	Duplex	Port operation
83	161.7750	157.1750	Duplex	Port operation
84	161.8250	157.2250	Duplex	Marine operator





Ch No.	RX Freq	TX Freq	Status	Name on display
85	161.8750	157.2750	Duplex	Marine operator
86	161.9250	157.3250	Duplex	Marine operator
87*	157.3750	157.3750	Simplex	Marine operator
88*	157.4250	157.4250	Simplex	Marine operator

\*Channels 87 & 88 revert from duplex to simplex operation. AIS channels are not supported.

## Weather Channels and Frequencies (US, CAN, and INT)

Ch No.	RX Freq	Name on display
WX01	162.5500	162.550 MHz
WX02	162.4000	162.400 MHz
WX03	162.4750	162.475 MHz
WX04	162.4250	162.425 MHz
WX05	162.4500	162.450 MHz
WX06	162.5000	162.500 MHz
WX07	162.5250	162.525 MHz
WX08	161.6500	161.650 MHz
WX09	161.7750	161.775 MHz
WX10	163.2750	163.275 MHz

## Emergency Alert System (SAME) Information

### Types of events

- A WARNING is an event that alone poses a significant threat to public safety and/or property, probability of occurrence and location is high, and the onset time is relatively short.
- A WATCH meets the classification of a warning, but either the onset time, probability of occurrence, or location is uncertain.
- An EMERGENCY is an event that, by itself, would not kill or injure or do property damage, but indirectly may cause other things to happen that result in a hazard. For example, a major power or telephone loss in a large city alone is not a direct hazard, but disruption to other critical services could create a variety of conditions that could directly threaten public safety.
- A STATEMENT is a message containing follow up information to a warning, watch, or emergency.

Event	SAME Code	Type
Blizzard Warning	BZW	Warning
Coastal Flood Watch	CFA	Watch
Coastal Flood Warning	CFW	Warning
Dust Storm Warning	DSW	Warning
Flash Flood Watch	FFA	Watch





<b>Event</b>	<b>SAME Code</b>	<b>Type</b>
Flash Flood Warning	FFW	Warning
Flash Flood Statement	FFS	Statement
Flood Watch	FLA	Watch
Flood Warning	FLW	Warning
Flood Statement	FLS	Statement
Freeze Warning	FZW	Warning
High Wind Watch	HWA	Watch
High Wind Warning	HWW	Warning
Hurricane Watch	HUA	Watch
Hurricane Warning	HUW	Warning
Hurricane Statement	HLS	Statement
Severe Thunderstorm Watch	SVA	Watch
Severe Thunderstorm Warning	SVR	Warning
Severe Weather Statement	SVS	Statement
Special Marine Warning	SMW	Warning
Special Weather Statement	SPS	Statement
Tornado Watch	TOA	Watch
Tornado Warning	TOR	Warning
Tropical Storm Watch	TRA	Watch
Tropical Storm Warning	TRW	Warning
Tsunami Watch	TSA	Watch
Tsunami Warning	TSW	Warning
Winter Storm Watch	WSA	Watch
Winter Storm Warning	WSW	Warning
National Information Center	NIC	Statement
Avalanche Watch	AVA	Watch
Avalanche Warning	AVW	Warning
Child Abduction Emergency	CAE	Statement
Civil Danger Warning	CDW	Warning
Civil Emergency Message	CEM	Statement
Earthquake Warning	EQW	Warning
Immediate Evacuation	EVI	Warning
Fire Warning	FRW	Warning
Hazardous Material Warning	HMW	Warning
Law Enforcement Warning	LEW	Warning
Local Area Emergency	LAE	Statement
911 Telephone Outage Emergency	TOE	Statement
Nuclear Power Plant Warning	NUW	Warning







Event	SAME Code	Type
Radiological Hazard Warning	RHW	Warning
Shelter In-Place Warning	SPW	Warning
Volcano Warning	VOW	Warning
Administrative Message	ADR	Statement
Practice/Demo	DMO	Test
Required Monthly Test	RMT	Test
Required Weekly Test	RWT	Test
Biological Hazard Warning	BHW	Warning
Boil Water Warning	BWW	Warning
Chemical Hazard Warning	CHW	Warning
Dam Watch	DBA	Watch
Dam Break Warning	DBW	Warning
Contagious Disease Warning	DEW	Warning
Emergency Action Notification	EAN	Warning
Emergency Action Termination	EAT	Statement
Evacuation Watch	EVA	Watch
Food Contamination Warning	FCW	Warning
Flash Freeze Warning	FSW	Warning
Iceberg Warning	IBW	Warning
Industrial Fire Warning	IFW	Warning
Landslide Warning	LSW	Warning
National Audible Test	NAT	Test
Network Notification Message	NMN	Statement
National Periodic Test	NPT	Test
National Silent Test	NST	Test
Power Outage Advisory	POS	Statement
Wild Fire Watch	WFA	Watch
Wild Fire Warning	WFW	Warning
Unrecognized Watch	**A	Watch
Unrecognized Emergency	**E	Statement
Unrecognized Statement	**S	Statement
Unrecognized Warning	**W	Warning

### No Response Event Code

TXB	Transmitter Backup On
TXF	Transmitter Carrier On
TXO	Transmitter Carrier On
TXP	Transmitter Primary On



## NMEA Operation

This radio supports NMEA0183 version 3.01.

### NMEA Input

If you have difficulty getting your radio to receive data from your GPS receiver, check the device's configuration. It should be set to the following parameters:

Baud rate	4800 bps
Data bits	8
Parity	None
Stop bits	1
Data amplitude	Over 3.0 V
Drive capability	Over 10 mA

The radio supports RMC, GLL, GNS, GGA and ZDA sentences. When these sentences are received, the radio displays latitude/longitude, date, time, course, and speed. If any sentence except an RMC or GLL sentence is received, the radio uses the information based on the following priority order.

- Status:RMC > GLL > GNS > GGA
- Latitude/Longitude:RMC > GLL > GNS > GGA
- UTC Time: RMC > GLL > GNS > GGA > ZDA
- Date: RMC > ZDA
- Speed / Course:RMC

**NOTE 1:** If the radio receives only a GLL sentence, the radio does not display the current speed, course, and date.

**Note 2:** If the radio receives both RMC and GLL sentences, the radio uses only the RMC sentence.

**Note 3:** Status data is used to check whether the GPS data is valid or invalid.

### NMEA Output

When the radio receives a DSC call (Distress, Position Reply, or Position Send), it outputs a DSC/DSE sentence from the NMEA output port.

**NOTE:** When the radio receives a distress call, it outputs a sentence in the following format.

- \$CDDSC,12,3081234000,,07,00,0354013946,0657,,,S,E\*6D
- \$CDDSE,1,1,A,3081234000,00,60875646\*13

## Regulations and Safety Warnings

### Maritime radio services operation

**Warning!** This transmitter will operate on channels/frequencies that have restricted use in the United States. The channel assignments include frequencies assigned for exclusive use of the U.S. Coast Guard, use in Canada, and use in international waters. Operation on these frequencies without proper authorization is strictly forbidden. See the channel tables beginning on page 37 for a list of available channels and their uses. If you are still not certain which channels to use, see the FCC maritime radio page at the FCC website (<http://wireless.fcc.gov/marine/>) or contact the FCC Call Center at 1-888-CALLFCC. For



individuals requiring a license, such as commercial users, you should obtain a license application from your nearest FCC field office (for US users) or Industry Canada (for Canadian users).

## Basic radio guidelines

You should familiarize yourself with the rules on marine radios and be aware of which rules apply to your boat. Complete guidelines for all ship and marine radio types can be found at the US Coast Guard website under the topic Radio Info for Boaters (the direct link is <http://www.navcen.uscg.gov/marcomms/boater.htm>). Here are a few guidelines that affect nearly all boaters.

- If you have a VHF radio on your boat, you must maintain a watch on channel 16 (156.800 MHz) whenever the radio is not being used to communicate. Effective from 2004, if a radio is carried, it must be turned on and set to channel 16 whenever your vessel is underway.
- If you hear a distress call, wait a few minutes to let a shore station or Coast Guard vessel respond. If no other station has responded after 5 minutes, you must respond to the distress call.
- Do not make false mayday or distress calls as a prank or to test your radio. (This is essentially like making a false 9-1-1 call; you may be subject to fines.)

## FCC Information

This device complies with Part 15 of the FCC Rules. Operation is subject to the condition that this device does not cause harmful interference.

Unauthorized changes or modifications to this equipment may void compliance with the FCC Rules. Any change or modification must be approved in writing by Uniden.

Any changes or modifications not expressly approved by the party responsible for compliance could void the user's authority to operate this device.

## Lead warning

The cords on this product and/or accessories contain lead, a chemical known to the State of California to cause birth defects or other reproductive harm. **Wash hands after handling.** Uniden works to reduce lead content in our PVC coated cords in our products and accessories.

## Antenna Selection and Installation

Your VHF580 has been designed to accommodate all of the popular marine VHF antennas. However, the selection and the installation of the antenna is the responsibility of the user or installer.

The FCC has determined that excessive radiation poses a health risk to people near radio transmitting antennas. Therefore, the antenna used with this radio should be installed using the following guidelines to ensure a suitable distance between the antenna and persons close by.

- Small whip antennas (3 dB) or smaller should be installed keeping at least a two foot separation distance between the radiating element and people.
- Medium antennas (6 dB) should be installed keeping at least a three foot separation distance.
- Larger antennas (9 dB) should be installed keeping at least a four foot separation distance.
- No person should touch the antenna or come into the separation distance when the radio is transmitting.

## Three Year Limited Warranty

WARRANTOR: UNIDEN AMERICA CORP. ("Uniden")

ELEMENTS OF WARRANTY: Uniden warrants, for three years, to the original retail owner, this Uniden Product to be free from defects in materials and craftsmanship with only the limitations or exclusions set out below.





**WARRANTY DURATION:** This warranty to the original user shall terminate and be of no further effect 36 months after the date of original retail sale. The warranty is invalid if the Product is (A) damaged or not maintained as reasonable or necessary, (B) modified, altered, or used as part of any conversion kits, subassemblies, or any configurations not sold by Uniden, (C) improperly installed, (D) serviced or repaired by someone other than an authorized Uniden service center for a defect or malfunction covered by this warranty, (E) used in any conjunction with equipment or parts or as part of any system not manufactured by Uniden, or (F) installed or programmed by anyone other than as detailed by the Operating Guide for this product.

**STATEMENT OF REMEDY:** In the event that the product does not conform to this warranty at any time while this warranty is in effect, warrantor will either, at its option, repair or replace the defective unit and return it to you without charge for parts, service, or any other cost (except shipping and handling) incurred by warrantor or its representatives in connection with the performance of this warranty. Warrantor, at its option, may replace the unit with a new or refurbished unit. **THE LIMITED WARRANTY SET FORTH ABOVE IS THE SOLE AND ENTIRE WARRANTY PERTAINING TO THE PRODUCT AND IS IN LIEU OF AND EXCLUDES ALL OTHER WARRANTIES OF ANY NATURE WHATSOEVER, WHETHER EXPRESS, IMPLIED OR ARISING BY OPERATION OF LAW, INCLUDING, BUT NOT LIMITED TO ANY IMPLIED WARRANTIES OF MERCHANTABILITY OR FITNESS FOR A PARTICULAR PURPOSE. THIS WARRANTY DOES NOT COVER OR PROVIDE FOR THE REIMBURSEMENT OR PAYMENT OF INCIDENTAL OR CONSEQUENTIAL DAMAGES.** Some states do not allow this exclusion or limitation of incidental or consequential damages so the above limitation or exclusion may not apply to you.

**LEGAL REMEDIES:** This warranty gives you specific legal rights, and you may also have other rights which vary from state to state. This warranty is void outside the United States of America.

**PROCEDURE FOR OBTAINING PERFORMANCE OF WARRANTY:** If, after following the instructions in this Operating Guide you are certain that the Product is defective, pack the Product carefully (preferably in its original packaging). Include evidence of original purchase and a note describing the defect that has caused you to return it. The Product should be shipped freight prepaid, by traceable means, or delivered, to warrantor at:

Uniden America Corporation  
Parts and Service Division  
4700 Amon Carder Boulevard  
Ft. Worth, TX, 76155











**QUESTIONS?**  
Visit our website at  
[www.uniden.com](http://www.uniden.com) or  
call 1-800-297-1023.

**QUESTIONS?**  
Contactez-nous au  
[www.uniden.com](http://www.uniden.com) ou  
appelez 1-800-297-1023.

**¿PREGUNTAS?**  
Comuníquese con nosotros  
en [www.uniden.com](http://www.uniden.com) o  
llame al 1-800-297-1023.

Printed in China / Imprimé en Chine / Impreso en China UTZZ01636ZZ(0)

