



500JXX432

September 01 - 2013

AMATEUR RADIO RF POWER MOSFET AMPLIFIER



Full protection IN - OUT

Contents

1	General characteristics	pag. 2
2	Diagram block	pag. 3
3	Connections	pag. 4
4	Front controls	pag. 4
5	Input power adjustment	pag. 5
6	Overdrive alarm	pag. 5
7	Temperature alarm	pag. 6
8	Power reflected alarm	pag. 6
9	Remote control from PC	pag. 7
10	Software configuration	pag. 8/10

GENERAL CHARACTERISTICS

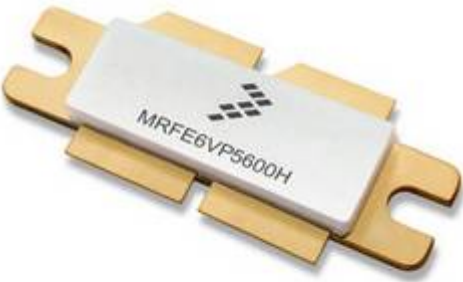
Operating band	430 ÷ 440 MHz
Driving power	0 ÷ 30 Watt (Typ. 10 Watt) - Through 100 Watt
Output power	500 Watt ±0.5 dB
IN / OUT RF connectors	N female
Coaxial relay	CX-140D (input) - RDL SR012 (output)
Input SWR	1 : 1.5 max
SWR	1 : 2.0 max
Microcontroller	PIC18F67K90 - 64 MHz
Flange temperature	Max 75°
Fan speed	Auto adaptive on temperature and power
Mosfet efficiency	>55 %
Ambient working temperature	0° to 30°C
Protections	OVERDRIVE - SWR - Temperature
AC power	180 ÷ 240 VAC 50 ÷ 60Hz
AC power consumption	900 watt = @230 Vac
PTT	TX with ground on RCA
Box dimensions	300 x 100 x 410 mm
Weight	8 Kg
	Mosfet Freescale MRF6VP5600H

* The above data is purely indicative; we may vary them without any notice

2 Diagram Block / Schema a Blocchi

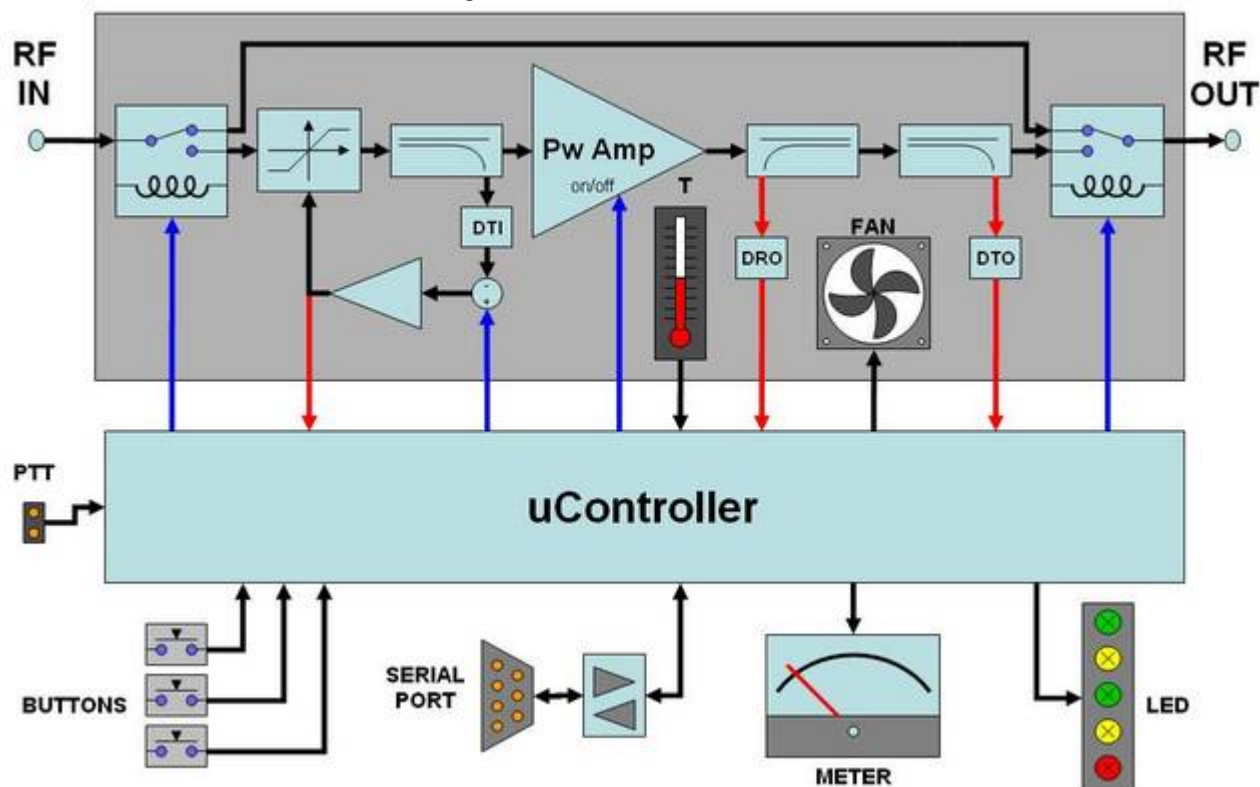

This new project "500JXX432" is a complete "ready to go" and extremely linear, compact, machine leading to Ham shack. Its reduced weight (7.8 kg.) enhances the DXpedition SSB, CW, WSJT , MS or EME and allows access to the airport to check-in as "hand baggage."

The P.A. is different from commercial products as it comes with COMPLETE PROTECTION (overdrive, SWR, temperature) through a microprocessor, able to intervene with a response time of less than 500 μ S, which will help to save the mosfet, from any failure.

The protection of the Overdrive is unique as it allows also to overcome the threshold of pilot (normally 10 watts), in which case it will intervene the Overdrive gradually, indicating that the threshold has been exceeded by the yellow OV.DR. and at the same time, it sends over to the internal dummy load, set up to maximum power of 30 watts, once protection is activated, the machine will switch mode "through".

A valuable specification of this project is that you can use the remote PC, using software "INCLUDED", which, via RS232, allows you to manage the same functions remotely as the front panel and other additional user-configurable such as double-wattmeter, SWR meter, digital temperature, fan speed, power chart, transmission time, etc..

The machine comes complete in all its parts, with RF PCBoard, Vdc switching power supply with PFC, coaxial relays, internal dummy load, directional couplers, low-pass filter, wattmeter, power cable, CD with FW and PDF manual.

3 Connections



3 Connections

- 3.1 N connector from transmitter on RTX (do not use adapters N to PL)
- 3.2 N connector from antenna on ANT (do not use adapters N to PL)
- 3.3 RCA male from transmitter with ground in TX on PTT
- 3.4 Plug from mains on 180 ÷ 250 Vac
- 3.5 Serial cable from PC on RS232 (REMOTE control)

4 Front Controls

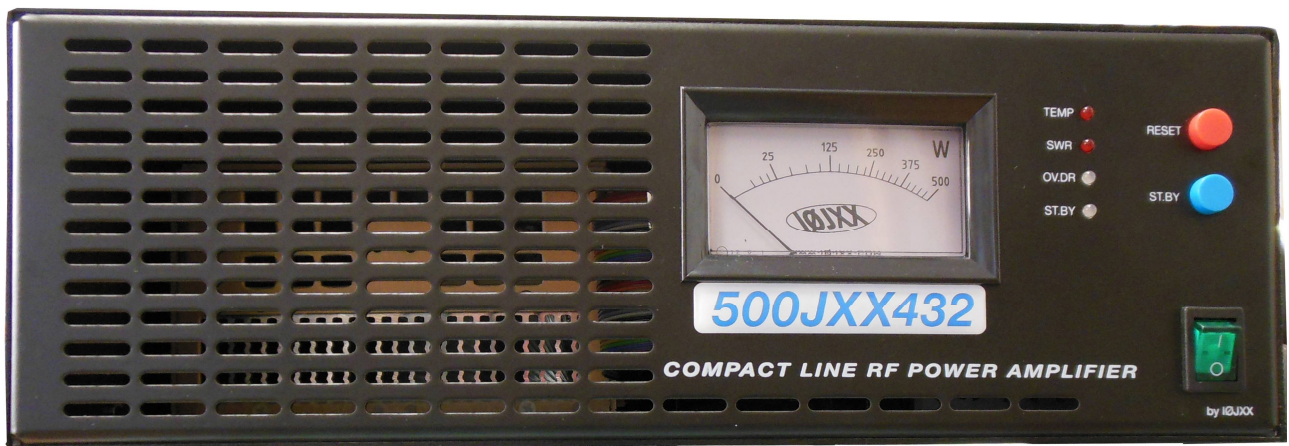

4 Frontal Controls



- 4.1 Switch ON with green switch (about 5 sec. for int. test)
- 4.2 On the sequence there will be shown: LEDs, wattmeter and the fans
- 4.3 The P.A. will be positioned in ST.BY with its red LED

5 Input power adjustment

CONTROL POWER INPUT Highly important for the function of the overdrive, the PA is set at the factory to work from 0 to 30 watts, you simply adjust the input power to 10 watts, however, until the LED OV.DR remains witted off.

If it exceeds the threshold of the correct input power the LED OV.DR will begin to flash (YELLOW) and at the same time, the internal protection circuit will send the excess power dummy load, so as not to damage the MOSFET.

We recommend for a better "linearity" DO NOT use the machine under yellow light flashing.

If the power exceeds the factory setting (30 watt) will intervene to protect OV.DR and the red led become fixed by placing the machine in "through".

The RESET button can restart the PA, the protection will trip forever, as long as the power will not be reduced to the proper value for the year.

With two directional couplers, the output power can be measured constantly, directly and reflected, and the values of SWR and return loss. Also improved have been the operating temperature, the fan system and the state of early warning and alarm conditions.

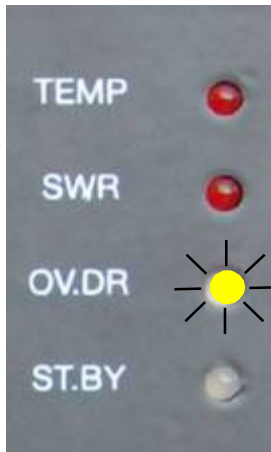

5 Input power adjustment (after switching on P.A. as show on section 2)

- 5.1 Set RTX to 10 watts in FM
- 5.2 Press PTT
- 5.3 Check the power output (500 watt \pm 0.5 dB)
- 5.4 The yellow LED will NOT blink
- 5.5 Adjust power input if necessary

6 Overdrive alarm

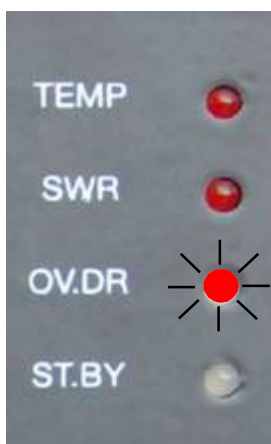

6 Overdrive alarm

- 6.1 With the OVERDRIVE the yellow LED OV.DR will blink up to a 30 Watt input (Section 5)
- 6.2 Over 30 Watt OV.DR protection will turn red LED firm
- 6.3 The P.A. will be through
- 6.4 Reduce de input power
- 6.5 Restore P.A. with the red RESET button

7 Temperature alarm

TEMPERATURE ALARM The P.A. has an efficient temperature control system, thanks to the development of the microprocessor which manages the scale with an accuracy of 1° C.

The temperature probes are placed on the flange of the MOSFET and allow the usage of the car to notice that the threshold is set at 75° C.

When this value has been reached, the LED will start flashing a red temp for further 5° C , after which, having reached 80° C. the "Temperature Protection" comes into operation.

Should the P.A. (TEMP LED firm red) intervene, the machine sets up automatically " through " and as long as the temperature will not fit the values of the exercise, it can not be reset, even when pressing the red button RESET, it will remain in protection.



7 Temperature Alarm

7.1 TEMP LED red flashing light alerting the threshold of 5 ° protection

7.2 TEMP LED permanent red intervened protection and PA in "through" mode

7.3 Press the button with the red RESET (only if the temperature is at the threshold)

8 Power reflected alarm

POWER ALARM REFLECTED P. A. is protected against SWR and can operate up to a maximum value of 1: 2.0 , if this threshold is exceeded , the machine will go into protection mode and prepare to " through " (SWR LED solid red), you can restore the transmission by pressing the button red RESET.

If security continues to intervene, the antenna and its connections are to be checked.

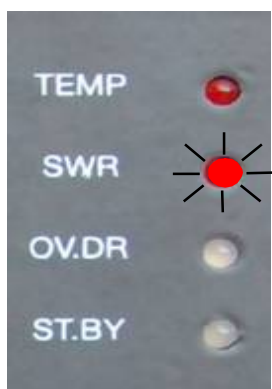

8 Power Reflected Alarm

8.1 SWR LED permanent red protection activated and PA in through mode

8.2 Press the red RESET button

9 Remote control from PC

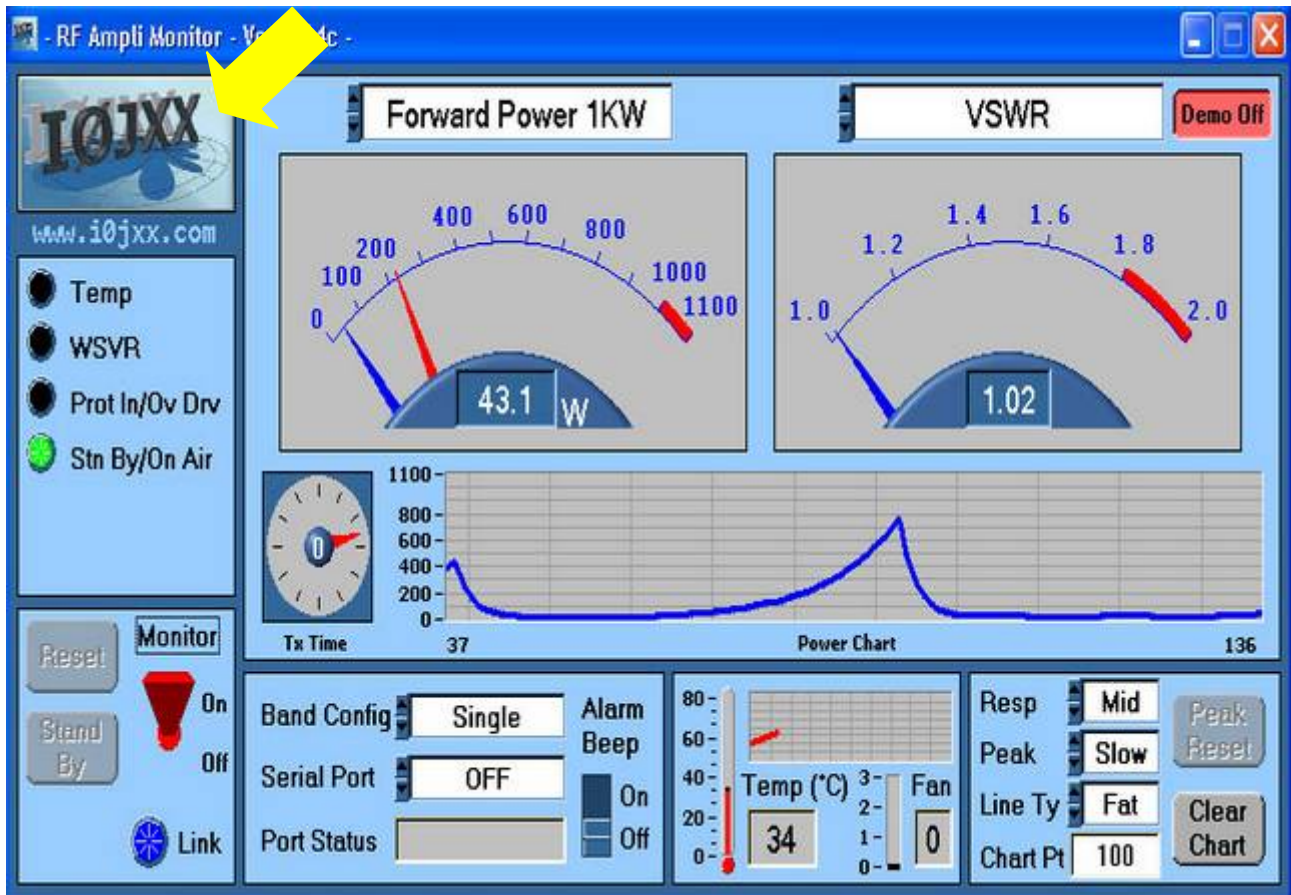

Make sure to have properly connected the RS232 cable and installed the software that came with P. A. "RF Amplifier Monitor".

The software allows remote monitoring of the P.A. remote control repeating and extending the functions of the front panel via RS232.

Thanks to the internal directional couplers, the output power can be constantly measured, the values of SWR and return loss reflected, also, the acquired operating temperature, the system of fans and the state of pre-alarm conditions and alarm.

You can save the window by clicking on the logo IØJXX



10 Software configuration

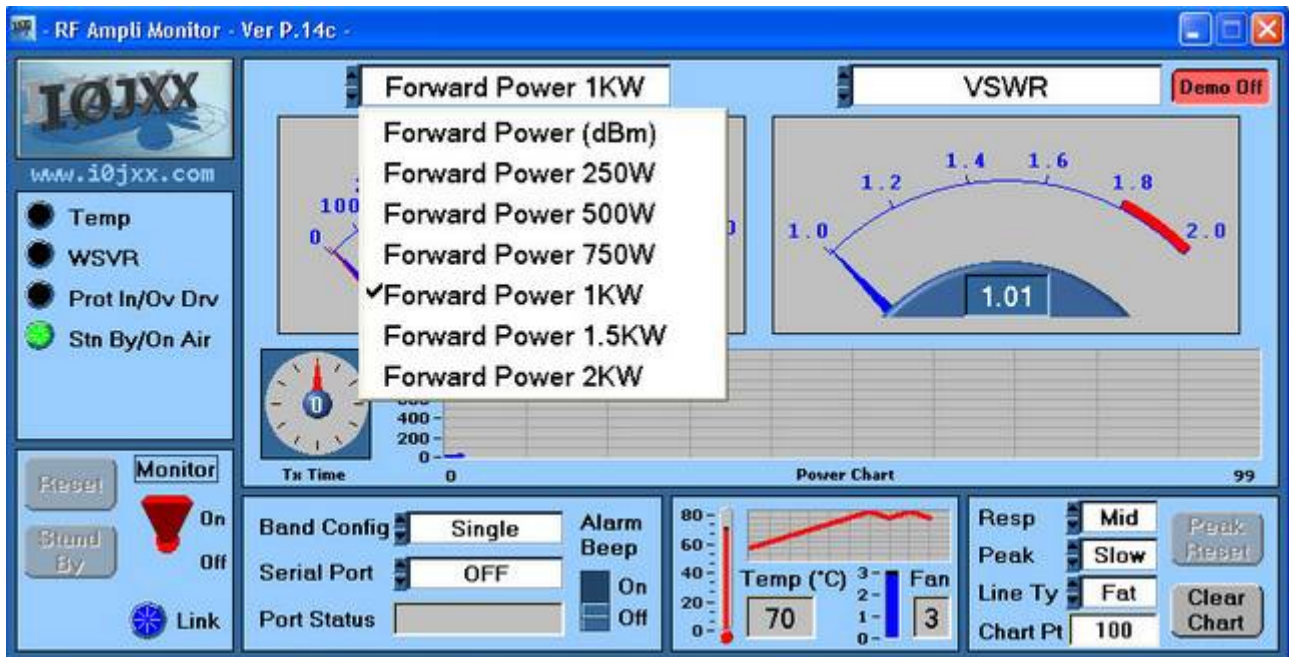

10 Software configuration

10.1 Select the Serial Port (COM)

10.2 Enable the connection via the red switch (On / Off)

10.3 If OK, the blue LED will turn on Link, with Reset and Stand By

10.4 Select the writing at the end of the scale as for the output power (Power Forward) Watt o dBm

10.5 Choose an indication of the reflected power (VSWR) Watt, Return Loss or dBm

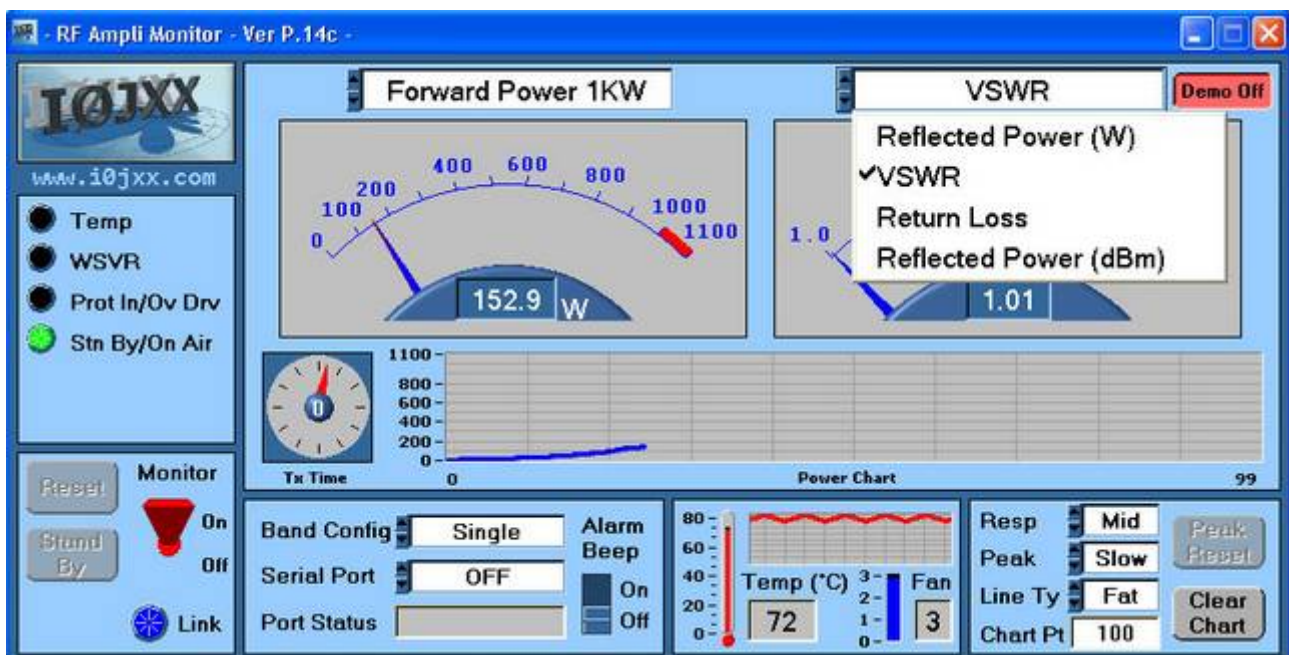

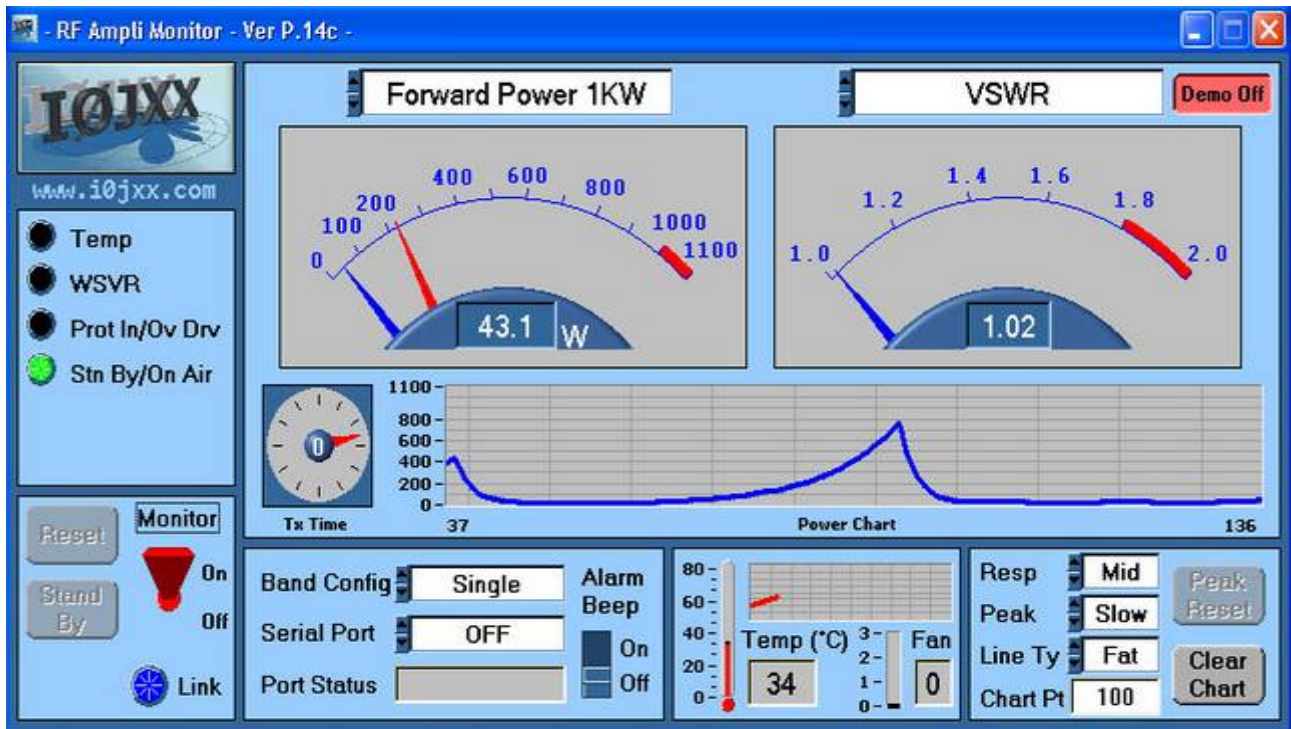

With the switch "Resp" you can change the speed of the response of the analog gauges going to select the preferred between Fast and Slow Mid.

The power indicator has a direct double-needle cover to indicate both the actual value (needle blue) and the peak value (red needle) with the selector "Peak" mode you can change the indication of the peak values of None (without indication of the peak), Hold (maintenance of peak to pressing the "Peak Reset"), Slow and Fast (automatic return after a long or short).

The "power chart" shows the performance of the TX power from the beginning of a new transmission (PTT activation).

This scale is configurable by the user as desired, taking as the maximum value selected for the Power Meter and as lasting value "Pt Chart" in which the units are 100 mS.

The temperature indication is given either in the form of the actual value or as a graph of the last 100 seconds.

Guarantee: The guarantee of the machine is valid for one year from the date of purchase. The guarantee does NOT cover possible rupture of the Mosfet. The guarantee does NOT cover any misuse of the equipment and failure to comply with the instructions above. Shipping costs are at the customer's charge.

PATENT PENDING

Remoterig Microbit & Adaptors RS232 / USB compatible

Serial Setting on COM 1 of RRC-1258 MKII of Remoterig Microbit 2.0 AB

COM1 mode Mode-3, char-timeout
 COM1 baudrate 9600
 COM1 data bits 8
 COM1 stop bits 1
 COM1 parity 0 - Off
 COM1 rts/cts No
 COM1 terminator
 (hex) Od



Cable connection to the plugs RS232 COM1 of RRC-1258 MKII of Remoterig Microbit 2.0 AB

PC RRC-1258
 COM 1 (Control end)

9-pol D-sub female 9-pol D-sub male

```

3 0----->-----0 3
2 0-----<-----0 2
5 0-----0 5
  
```

RRC-1258 — Power Amplifier
 COM 1 — 500JXX432 (radio end)
 9-pol D-sub male 9-pol D-sub male

```

3 0-----<-----0 2
2 0----->-----0 3
5 0-----0 5
  
```

Thanks to
 IK4ADE Franco

