

A-99

HAM ♦ CB ♦ COMMERCIAL

FIBERGLASS OMNIDIRECTIONAL BASE STATION ANTENNA

CB/Ham Radio Base Station Antenna

Your Solarcon CB/Ham Base Station Antenna comes in three easy-to-assemble sections and covers far above and below traditional CB channels. You can also use your antenna for international, commercial and 10-meter amateur radio operation with up to 2000 watts. Twin ring tuning makes it easy to tune the input to the antenna for the optimum standing wave ratio (SWR) over a range of frequencies. The antenna is designed as a half wave over a quarter wave variable mutual transductance tuned antenna.

BEFORE YOU BEGIN

Before you begin installation, read this manual and the separate Consumer Product Safety Commission information sheet. For your safety and convenience, plan each step of the installation in advance.

WARNING: When you install an outdoor antenna, use extreme caution. If the antenna starts to fall, let it go! It could contact overhead power lines. If the antenna touches the power line, contact with the antenna, mast, cable or guy wires can cause electrocution and death. Call the power company to remove the antenna. Do not attempt to remove it yourself!

SOLARCON, INC.

7134 RAILROAD STREET • P.O. BOX 176 • HOLLAND, OH 43528

ASSEMBLING THE ANTENNA

We recommend you assemble the antenna on the ground in a flat, open area. Follow these steps to assemble the antenna using the supplied hardware.

1. Slip a $\frac{3}{8}$ -inch lockwasher (A) over the threaded end of the small top section (B), then turn that section clockwise and connect it to the middle section (C).
2. Slip a $\frac{1}{2}$ -inch lockwasher (D) over the threaded end of the middle section (C), then turn that section clockwise and connect it to the bottom section (E).

MOUNTING THE ANTENNA

Using the supplied hardware, you can easily mount your antenna to a mast (not supplied), a building's vent pipe or other stationary object.

Note: For the best performance, mount your antenna at least 9 feet above the roof of the nearest building and 18 feet above or away from any metal object or structure.

1. Place the supplied U-bolts (F) around the bottom section of the antenna and the mounting location.
2. Slide a clamp (G) over each U-bolt, then slide a lock washer (H) over the end of each U-bolt.
3. To fasten the U-bolts in place, tighten the supplied hex nuts (I) tightly over the ends of each U-bolt.

Cautions:

- Be careful not to overtighten the hex nuts, otherwise you might damage the antenna.
- Do not use caulk or silicone sealant around any part of your antenna, otherwise moisture might not drain properly from around the antenna. This could damage the antenna or cause it to work improperly.

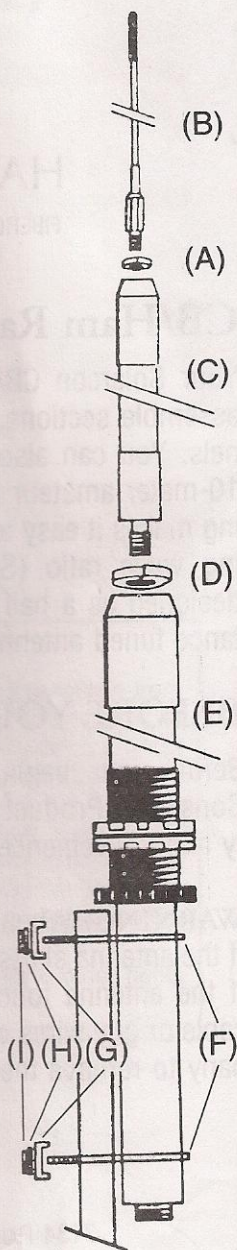

TUNING THE ANTENNA

Follow these steps to prepare your antenna and tune it with an SWR meter (not supplied) for use with radio equipment.

NOTE: Your antenna is pretuned to the middle of the CB band (27.205 MHz) for the lowest SWR (standing wave ratio). No tuning is necessary to use your antenna with a CB.

1. Look up the frequency you use most often in the Frequency/Antenna Length table on page 6, then carefully measure and cut off the recommended length of the antenna's top section.

IMPORTANT! Be sure you cut off only the length recommended to operate on the desired frequency. If you cut off too much of the antenna, you might need to replace the antenna's top section to receive some lower frequency. If needed, you can purchase a replacement top section through your dealer.

Note: No cutting is needed to operate your antenna at 10—20 meters if you use an antenna tuner.

2. Using an SWR meter, check the SWR at the top and bottom of the band.

Notes:

- If you are using a watt meter, the meter should read full output power at the transmitter, and (after calibration) in the SWR position, SWR should be low (preferably 2:1 or less).
 - The best place to check SWR is at the antenna's coaxial connection. You can also check SWR at the transmitter's coaxial connection.
3. If the SWR is higher at the top of the band than it is at the bottom, turn both tuning rings (A) $\frac{1}{4}$ - to $\frac{1}{2}$ -turn counterclockwise to raise them.

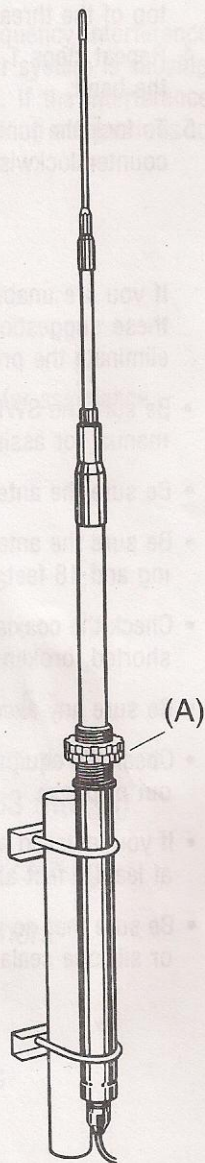

Note: For frequencies higher than 31.571 MHz, position the tuning rings at the top of the threaded section, then skip to Step 5.

4. Repeat steps 1 and 2 until the SWR reading is the lowest possible at both ends of the band.
5. To lock the tuning rings in place, turn the top ring clockwise and the bottom ring counterclockwise, so they rest tightly against each other.

TROUBLESHOOTING

If you are unable to obtain an acceptable SWR reading from your antenna, follow these suggestions to see if you can eliminate the problem. If you are unable to eliminate the problem, contact your dealer for assistance.

- Be sure the SWR equipment is working properly— check the SWR meter's owner's manual for assistance in operating it.
- Be sure the antenna's grounding location is grounded properly.
- Be sure the antenna is installed at least 9 feet above the roof of the nearest building and 18 feet above or away from any other metal objects in the area.
- Check the coaxial cable and all of its connections. Be sure the cable is not pinched, shorted, broken or kinked.
- Be sure any excess coaxial cable is not coiled, causing excess SWR.
- Check the equipment installation sequence, and be sure the amplifier is not installed out of phase.
- If you installed an optional ground plane kit on the antenna, be sure the radials are at least 9 feet above the roof.
- Be sure that no water is standing around the base of the antenna and that no caulk or silicone sealant has been used around the bottom of the antenna.

TIPS FOR ELIMINATING RFI

Your transceiver and antenna system might cause TV or radio frequency interference (RFI) even when it is operating properly. To determine whether your system is causing the interference, turn off the transceiver connected to the antenna. If the interference goes away, your system is causing it. Try one or more of the following suggestions to eliminate the interference.

- Be sure the mast or mounting location is grounded properly.
- Purchase a high quality, low pass filter like Solarcon's LP99.
- Check the transceiver to be sure it is operating properly.

If you are unable to eliminate the interference, contact your dealer for assistance.

SPECIFICATIONS

Maximum Power	2000 Watts
dBI Gain	9.9
Optimum SWR Range	Less than 1.5:1
Dimensions (height x diameter)	17 ft., 4½ in. x 1¾ in. ø (5.3 m. x 33 mm. ø)
Weight	5 pounds (2.27 kg)
Supplied Hardware	6 Lockwashers 2 U-bolts 2 Clamps 4 Hex Nuts

Specifications are typical, but individual units may vary. Specifications are subject to change and improvement without notice.

FREQUENCY/ANTENNA LENGTH TABLE

FREQ. (MHz)	TOP SECTION LENGTH (inches)	
	Remaining ▼	Cut Off ▼

28.016	64	8
28.106	63	9
28.267	62	10
28.372	61	11
28.468	60	12
28.565	59	13
28.630	58	14
28.723	57	15
28.840	56	16
28.956	55	17
29.102	54	18
29.205	53	19
29.528	52	20
29.456	51	21
29.528	50	22
29.633	49	23
29.743	48	24
29.890	47	25
29.965	46	26
30.090	45	27
30.204	44	28

FREQ. (MHz)	TOP SECTION LENGTH (inches)	
	Remaining ▼	Cut Off ▼

30.324	43	29
30.397	42	30
30.504	41	31
30.590	40	32
30.679	39	33
30.807	38	34
30.900	37	35
31.030	36	36
31.571	36	36
31.695	35	37
31.754	34	38
31.980	33	39
32.130	32	40
32.295	31	41
32.404	30	42
32.535	29	43
32.685	28	44
32.816	27	45
32.921	26	46
33.041	25	47
33.117	24	48

GPK-1

Groundplane kit for A-99

(OPTION)

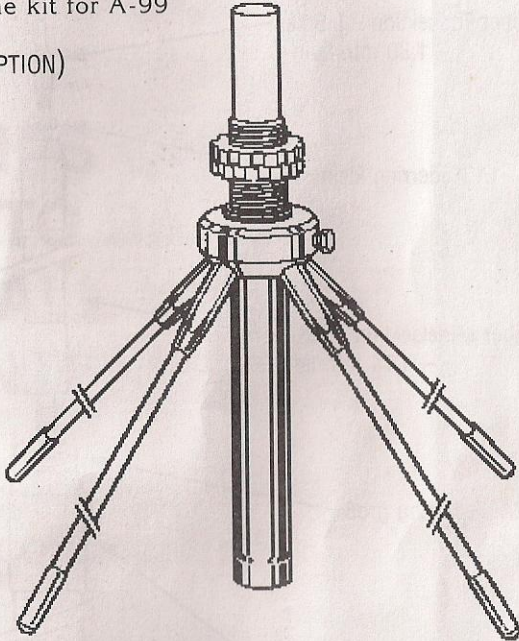

INSTALLATION INSTRUCTIONS

NOTE: RADIALS MUST BE 9 FEET ABOVE OR AWAY FROM ANY EXISTING STRUCTURE FOR MAXIMUM PERFORMANCE.

1. Insert aluminum bottom tube into ground plane collar and raise collar to the base of plastic threaded section.
2. Tighten the set screw.
3. Install the four fiberglass radials.
4. Install the A-99.

BE CAREFUL!
DO NOT STRIP THREADS!

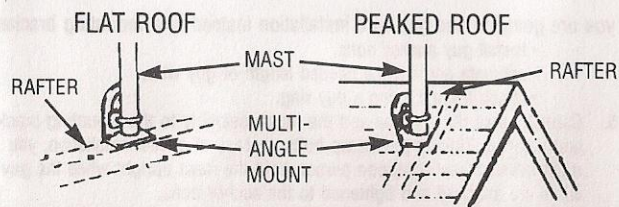

THE SAFE DISTANCE FROM POWER LINES IS AT LEAST TWICE THE COMBINED HEIGHT OF THE ANTENNA AND MAST.

CHIMNEY MOUNTING METHOD

The chimney is often an easy and convenient mounting place. But the chimney must be strong enough to support the antenna in high winds. Do not use a chimney that has loose bricks or mortar. A good chimney mount includes a 5- or 10-foot 1 1/4 inch diameter steel mast and a heavy duty, two strap clamp-type bracket. Install the upper bracket just below the top course of bricks and the lower bracket two or three feet below the upper bracket. For maximum strength, space the brackets as far apart as possible. **NOTE:** Guy wires are highly desirable on chimney mounts.

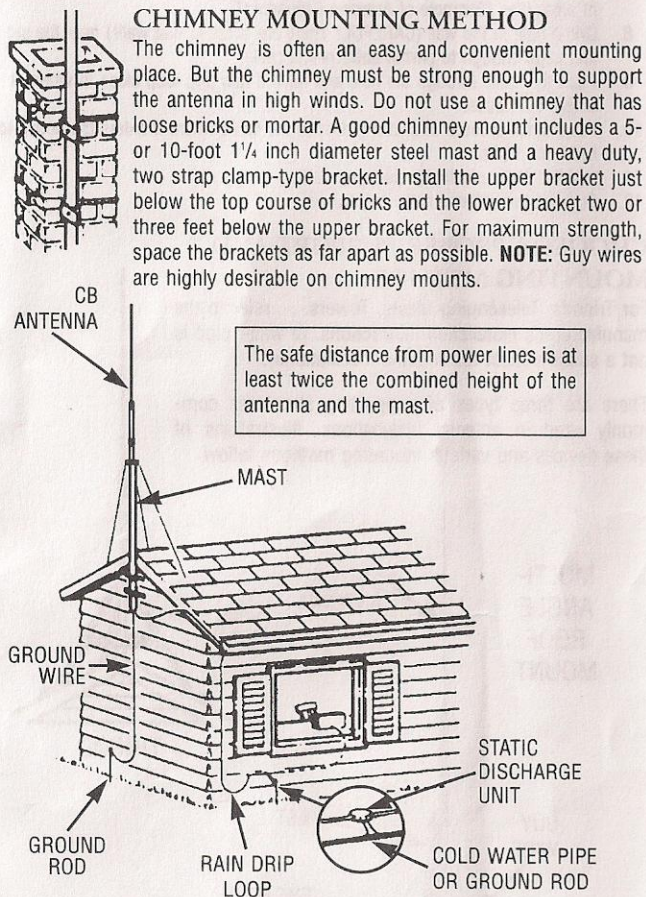

The safe distance from power lines is at least twice the combined height of the antenna and the mast.

SIDE-OF-HOUSE MOUNTING METHOD

Where roof overhang is not excessive, the side of the house provides a convenient mounting location. Position the brackets over a stud if possible, one above the other, and space them two or three feet apart. For metal siding, first mark mounting holes, then drill pilot holes through the siding to accept mounting screws. (CAREFUL! There are wires in that wall!)

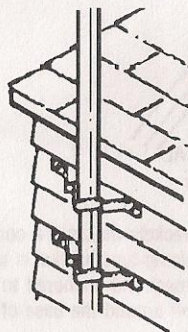

THESE MOUNTING STRUCTURES CAN BE FREE STANDING OR ALONG SIDE OF A BUILDING. Refer to the manufacturer's installation instructions.

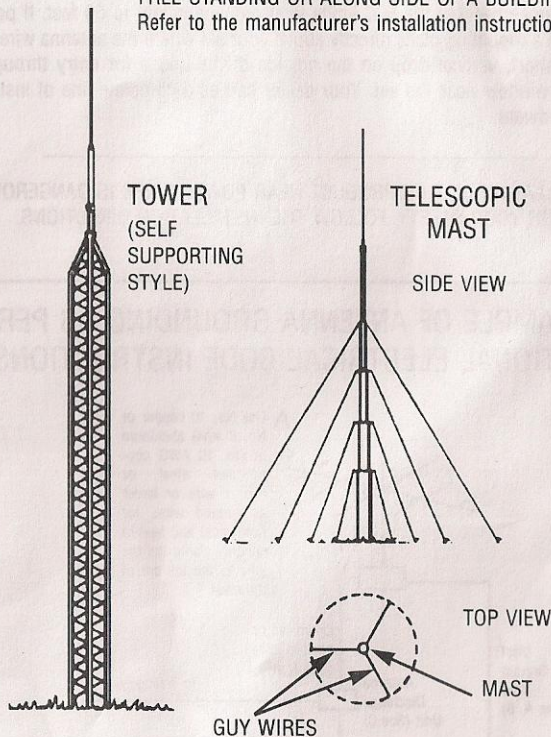

Guy wires should be equally spaced in at least three directions. Use at least three guy wires for each 10-foot section of mast.

WARNING: DO NOT INSTALL THE ANTENNA NEAR POWER LINES. FOR YOUR SAFETY, FOLLOW ALL INSTALLATION INSTRUCTIONS. CONTACT BETWEEN THIS ANTENNA AND A POWER LINE IS DANGEROUS AND MUST BE AVOIDED.

WARNING: UNDER SOME CONDITIONS, THIS ANTENNA MAY NOT PREVENT ELECTROCUTION. USERS SHOULD KEEP THIS ANTENNA AWAY FROM ANY OVERHEAD ELECTRIC POWER LINES. IF THE ANTENNA CONTACTS A POWER LINE, ANY INITIAL PROTECTION COULD FAIL AT ANY TIME. IF THE ANTENNA NEARS ANY OVERHEAD POWER LINES, IMMEDIATELY LET GO, STAY AWAY AND CALL YOUR UTILITY COMPANY.

WARNING!

INSTALLATION OF THIS PRODUCT NEAR POWER LINES IS DANGEROUS. FOR YOUR SAFETY, FOLLOW ALL INSTALLATION DIRECTIONS.

TIPS ON HOW TO SAFELY INSTALL YOUR ANTENNA

IN ACCORDANCE WITH THE RECOMMENDATIONS OF THE U.S. CONSUMER PRODUCT SAFETY COMMISSION.

THESE SAFETY RECOMMENDATIONS ARE FOR USE WITH CITIZENS BAND BASE STATION ANTENNAS.

INSTALLATION INSTRUCTIONS

YOU, YOUR ANTENNA AND SAFETY

Each year hundreds of people are killed, mutilated, or receive severe permanent injuries while attempting to install an antenna. In many of these cases, the victim was aware of the danger of electrocution, but did not take adequate steps to avoid the hazard.

For your safety, and to help you achieve good installation, please READ and FOLLOW the safety precautions below. THEY MAY SAVE YOUR LIFE!

1. If you are installing an antenna for the first time, please for your own safety as well as for others, seek professional assistance. Consult your dealer. They can explain which mounting method to use for the size and type antenna you are about to install.
2. Select your installation site with safety, as well as performance, in mind. (Detailed information on site selections appears below.) REMEMBER: ELECTRIC POWER LINES AND TELEPHONE LINES LOOK ALIKE. FOR YOUR SAFETY, ASSUME THAT ANY OVERHEAD LINES CAN KILL YOU!
3. Call your electric power company. Tell them your plans and ask them to come look at your proposed installation. This is a small inconvenience, considering your LIFE IS AT STAKE.
4. Plan your installation procedure carefully and completely before you begin. Successful raising of a mast or tower is largely a matter of coordination. Each person should be assigned a specific task and should know what to do and when to do it. One person should be designated as the "boss" of the operation to call out instructions and watch for signs of trouble.
5. When installing your antenna, REMEMBER—DO NOT USE A METAL LADDER and DO NOT WORK ON A WET OR WINDY DAY. Increase your personal safety by dressing properly for installation, i.e., wearing shoes with rubber soles and heels, rubber gloves, and a long sleeve shirt or jacket.
6. If the assembly starts to drop, get away from it, and let it fall. REMEMBER—the antenna, mast, cable and metal guy wires are all excellent conductors of electrical current. Even the slightest touch of any of these parts to a power line completes an electrical path through the antenna and the installer—YOU!
7. If any part of the antenna system should come in contact with a power line, DON'T TOUCH IT OR TRY TO REMOVE IT YOURSELF. Call your local power company, and they will remove it safely.
8. If an accident should occur and the victim is in contact with live wires, DO NOT TOUCH THEM! Move the victim away from contact using dry wooden boards, wooden broomsticks, dry rope, or a sheet or blanket. If breathing has ceased, begin artificial respiration and call for medical help immediately.

SITE SELECTION

Before attempting to install your antenna, think where you can best place it for safety and performance. To determine a safe distance from wires, power lines and trees:

1. Measure the height of your antenna.
2. Add this length to the length of your tower or mast.
3. Double this total for the minimum recommended safe distance.

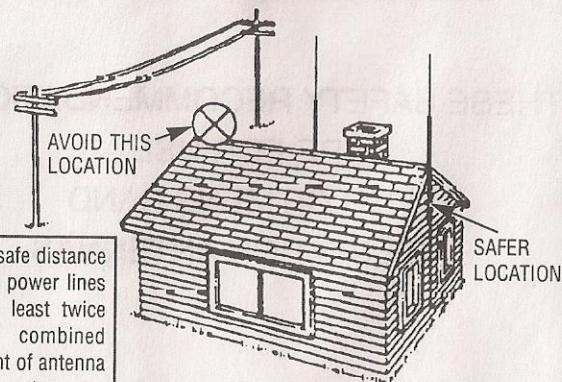

If you are unable to maintain this safe distance, STOP! GET PROFESSIONAL HELP! Most antennas are supported by pipe masts attached to the chimney, roof or side of the house. Generally, the higher the antenna is above ground, the better it performs. Good practice is to install your vertical antenna about 5 to 10 feet above the roof line and away from power lines and obstructions. Remember that the FCC limits your antenna height to 60 feet. If possible, find a mounting place directly above your set where the antenna wire can take a short, vertical drop on the outside of the house for entry through a wall or window near the set. Your dealer carries a complete line of installation hardware.

INSTALLATION OF THIS PRODUCT NEAR POWER LINES IS DANGEROUS. FOR YOUR SAFETY, FOLLOW THE INSTALLATION DIRECTIONS.

EXAMPLE OF ANTENNA GROUNDING AS PER NATIONAL ELECTRICAL CODE INSTRUCTIONS

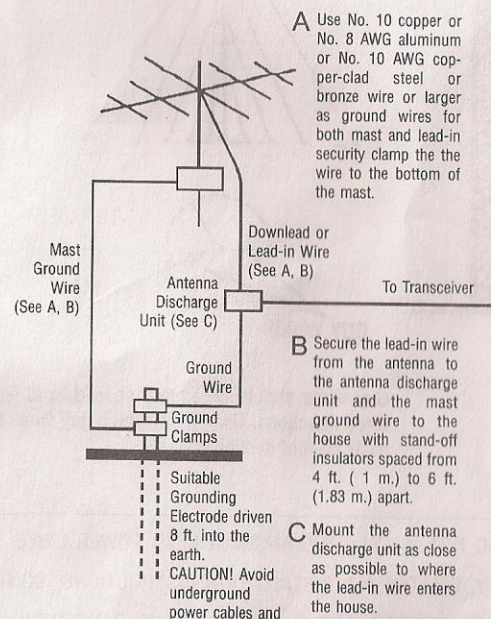

GENERAL INSTALLATION INSTRUCTIONS FOR MAST MOUNTED ANTENNAS

1. Assemble your new antenna on the ground at the installation site. Keep separate assembly instructions that come with it.
2. On the ground, clamp the antenna to the mast, pull enough coaxial cable and connect it to the antenna.
3. To insure that a mast does not fall the "wrong way" if it should get away from you during installation or takedown, durable non-conductive rope should be secured at each two foot level as the mast is raised. The "boss" stands in position where he can yank or pull the ropes if the need arises to deflect the falling mast away from hazards (such as power lines) into a "safe fall" (such as a yard or a driveway.) The ropes are tied taut at the base of the mast after installation and in place at the various levels.
4. Install the selected mounting bracket.

If you are going to use guy wire installation instead of a mounting bracket:

- Install guy anchor bolts,
 - estimate and cut the needed length of guy wire,
 - attach a mast using a guy ring.
5. Carefully take the antenna and the mast assembly to the mounting bracket and insert it. Tighten the clamp bolts. In case of guyed installation, you must have at least a second person hold the mast upright while the guy wires are attached and tightened to the anchor bolts.
 6. Install the self-adhering "DANGER" label packaged in the antenna hardware kit at eye level on your mast.
 7. Install a ground rod to drain off static electricity build up and connect a ground wire to the mast and ground rod. Use special ground rods, not a spare piece of pipe. (See "Example of Antenna Grounding")
 8. Drill a hole in the wall (CAREFUL! There are wires in that wall!) near the set just large enough to permit entry of the cable.
 9. Push the cable through the hole and form a rain drip loop close to where it enters the house.
 10. Put a small amount of caulking around the cable where it enters the house to keep out drafts.
 11. Install a static electricity discharge unit.
 12. Connect the antenna cable to your set.

CHOOSE A PROPER SUPPORT AND MOUNTING METHOD:

For Tripods, Telescoping Masts, Towers... refer to the manufacturer's installation instructions. (a water pipe is not a suitable mast for antenna installations).

There are three types of supporting structures commonly used in antenna installations. Illustrations of these devices and various mounting methods follow.

MULTI-ANGLE ROOF MOUNT

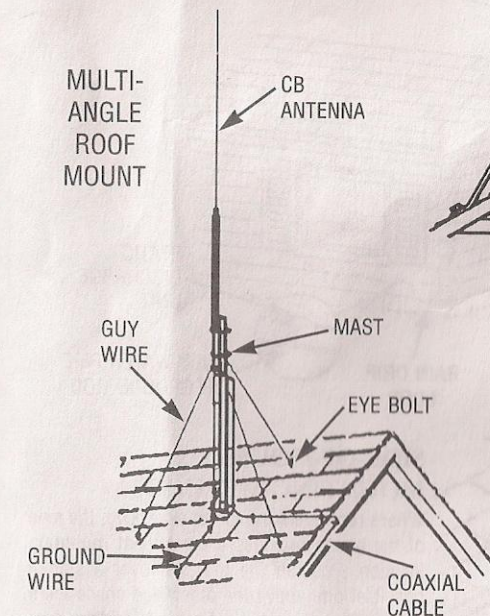

ROOF MOUNTING METHOD:

The swivel feature of "universal" type mounting brackets makes a convenient antenna mount for flat or peaked roofs. One clamp type bracket is used with 3 or 4 guy wires equally spaced around the mast and anchored to the roof or eaves by eye bolts. Apply roofing compound around the base of the bracket, screws, and eye bolts for moisture sealing.

