AR-146

AR-446

MOBILE TRANSCEIVER

USER'S MANUAL

ADI  **Communications**

Thank you for purchasing this VHF/UHF mobile Transceiver.

IMPORTANT:

Please read this instruction manual carefully before attempting operation.

SAVE THIS INSTRUCTION MANUAL.

CAUTION:

Long transmission or extended operation in the HI power mode might cause the rear of this transceiver to get warm.
Do not place the transceiver where the heat sink (rear panel) might come in contact with plastic or vinyl surfaces.

This Instruction Manual covers the following models.

AR-146 144MHz FM TRANSCEIVER

AR-446 430MHz FM TRANSCEIVER

NOTE:

If disregarded, inconvenience only, no risk of equipment damage or personal injury.

CAUTION:

Equipment damage may occur, but not personal injury.

FCC WARNING

This equipment generates or uses radio frequency energy. Changes or modifications to this equipment may cause harmful interference unless the modifications are expressly approved in the instruction manual. The user could lose the authority to operate this equipment if an unauthorized change or modification is made.

CONTENTS

1. BEFORE OPERATION
 2. SPECIFICATIONS
 3. ACCESSORIES
 4. INSTALLATION
 5. OPERATION
- CONTROL PANEL**
- RECEIVER**
- Reception
 - Frequency Selection
 - Frequency Memory
- TRANSMITTER**
- Time-out Timer
- MEMORY**
- Microprocessor
 - Initial State
 - Microprocessor
 - Memory Channel
 - Memory Enable
 - Memory Channel
 - Memory Shift
- SCAN**
- Scan Operation
 - Hold/Resume
 - Band Scan
 - Program Memory
 - Memory Channel
 - Memory Channel
 - DUAL-WAIT

CONTENTS

1. BEFORE OPERATION	3
2. SPECIFICATIONS	5
3. ACCESSORIES	6
4. INSTALLATION INSTRUCTIONS	6
5. OPERATION	
CONTROL FUNCTIONS	9
RECEIVER OPERATION	
Reception	14
Frequency Selection	15
Frequency Step Selection	15
TRANSMITTER OPERATION	16
Time-out Timer(TOT)	17
MEMORY	
Microprocessor Memory back-up	17
Initial State	17
Microprocessor Initialization	17
Memory Channel	18
Memory Entry	18
Memory Channel Recall	19
Memory Shift	19
SCAN	
Scan Operation	20
Hold/Resume Programming	20
Band Scan	20
Programmable Band Scan	21
Memory Channel Scan	21
Memory Channel Lockout	22
DUAL-WATCH OPERATION	22

REPEATER OPERATIONS

Transmitter Offsets	24
Reverse Function	24
Tone Operation	25
Tone Frequency Selection	25
TONE/CTCSS Operation	25
C.SQ (Code Squelch System) Operation	26
PAGING	29
DTMF CODE DECODING FUNCTION	34
APO(Automatic Power Off)	35
DIM(Dimmer)	35
BEEP	36
LOCK	36
CHANNELIZED FREQUENCY DISPLAY	37
6. MAINTENANCE	38
IN CASE OF DIFFICULTY	39

BEFORE OPERATION

TO PREVENT ELECTRIC SHOCK, FIRE AND OTHER INJURY. PLEASE NOTE THE FOLLOWINGS:

To avoid risk of electric shock, under no circumstances should the unit be opened.

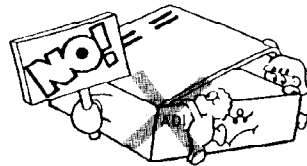

Do not place this unit, where it will be exposed to direct sunlight or close to heating appliances.

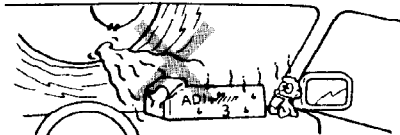

To ensure good ventilation, do not put anything on top of the cabinet and allow at least 15cm (6 inches) of space behind the unit.



The power requirement is 13.8 VDC.
Never attempt connection to a 24 VDC source.

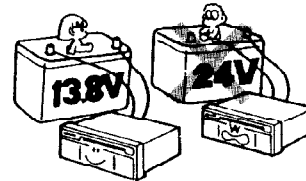

Do not place the Unit in areas off excessive dust, high humidity or on unstable surfaces.



Do not drop pieces of metal, needles, coins and other electrically conductive materials into the unit.



Do not touch

Do not pull the outlet. Grasp the live pins.

If an abnormality occurs, turn the unit off and pull the power cord from the outlet. Contact your dealer.

Do not touch the power plug, when your hands are wet.



Do not pull the power cord, when disconnecting it from the AC wall outlet. Grasp the plug and ensure that your fingers do not touch the live pins.



If an abnormal odor or smoke is detected, immediately turn the power off and pull out the power plug. Contact the ADI service station or our dealer.



CLEANING

1. Turn the power off, before cleaning the unit.
2. Do not use any type of abrasive pad, thinner, benzene or any substances which may damage the unit.
3. Wipe the front panel and other exterior surfaces of the unit with a soft dry cloth or a soft cloth lightly moistened with water.



2. SPECIFICATIONS

		AR-146(U.S.A)	AR-146	AR-446	
General	Frequency range MHz	144 to 148	144 to 146	430 to 440	
	Mode	F3E(FM)			
	Antenna impedance	50Ω			
	Operating temperature	-20°C to +60°C (-4°F to +140°F)			
	Power requirements	13.8V DC ± 15% (11.7~15.8V)			
	Ground	Negative			
	Current drain	Transmit mode	Less than 11A		Less than 10A
		Receiver mode	Less than 0.6A		
	Frequency stability	Less than ±10ppm			
	Dimensions (W×H×D)(mm)(Projections included)	140×40×166(5-1/2" × 1-37/64" × 6-17/32")			
weight (kg)	1.2(2.65lbs)				
Transmitter	Output power *	HI	50W	35W	
		MID	Approx 10W	Approx 10W	
		LOW	Approx. 5W	Approx. 5W	
	Modulation	Reactance modulation			
	Spurious radiation	Less than -60dB			
	Maximum frequency deviation	±5kHz			
Audio distortion(at 50% modulation)	Less than 3% (300 to 3000 Hz)				
Microphone impedance	600Ω				
Receiver	Circuitry	Double conversion superheterodyne			
	Intermediate frequency	1st/2nd	10.7MHz/455kHz	30.85MHz/455kHz	
	Sensitivity(12dB SINAD)	Less than 0.18 μV			
	Selectivity	-6dB: More than 12kHz -60dB Less than 24kHz			
	Squelch sensitivity	Less than 0.1 μV		Less than 0.177 μV	
	Output(5% distortion)	More than 2W across 8Ω loads			
	External speaker impedance	8Ω			

Notes:1. Circuit and ratings are subject to change without notice due to advancement in technology.
2. * Recommended duty cycle:1 minute:Transmit, 3 minutes Reception

ACCESS

Unpack your
damage If the
transportation
material for fu
The following
transceiver.

DTMF Micro
MC146D
or
Dynamic Micro
(GENERAL m
Hex wrench ..
Stacking plate
DC power Ca
Fuse(AR-146
(AR-446
Instruction M
Warranty Car

ACCESSORIES

Unpack your new transceiver carefully, and examine it for visible damage. If the equipment has been damaged in shipment, notify the transportation company immediately. Save the boxes and packing material for future shipping.

The following accessories should be included in the box with the transceiver.

DTMF Microphone

MC146D	1 ea.
or	
Dynamic Microphone (GENERAL market only) MC146	1 ea.
Hex wrench	1 ea.
Stacking plate	1 ea.
DC power Cable	1 ea.
Fuse (AR-146 15A)	1 ea.
(AR-446 10A)	1 ea.
Instruction Manual	1 copy
Warranty Card	1 ea.

INSTALLATION INSTRUCTIONS

4.1 INSTALLATION

Mounting Bracket

When installing the transceiver in a vehicle consider the ease of operation and safety when selecting the location for the mounting bracket.

1. Install the bracket using the supplied flat washers and self tapping screws (4 pcs. each).
2. Attach the transceiver loosely using the 4 SEMS screws.
3. Align the grooves in the bracket with the transceiver's screws (Fig. A) and slide the transceiver to the rear.
4. Adjust the viewing angle in the bracket to the desired position (Fig. B).
5. Hold the transceiver in place and tighten the 4 SEMS screws using the supplied wrench.

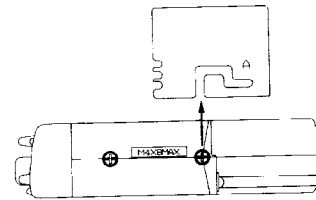

Fig. A

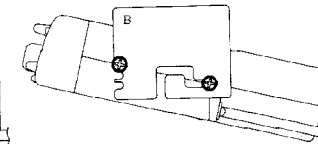

Fig. B

4-2 CONNECTION

4-2-1 Mobile Installations

Cautions:

1. Before installing the power cable, be sure to remove the negative lead from the battery for safety.
2. After installation and wiring, be sure to double check for correct installation before reconnecting the negative lead to the battery terminal.
3. If the fuse opens, be sure to check that each conductor has not been damaged by short circuiting, etc. Then replace with a new fuse of the same rating.
4. After completing the wiring, wrap the fuse holder with heat resistant tape to protect against heat and moisture.
5. Do not remove the fuse even if the power cable is too long.

A. Battery Connections

Connect the power cable directly to the battery terminals. Using of the cigarette lighter socket will lead to a poor connection, and will result in poor performance. Pay close attention to the polarity of the cables when connecting them to the battery.

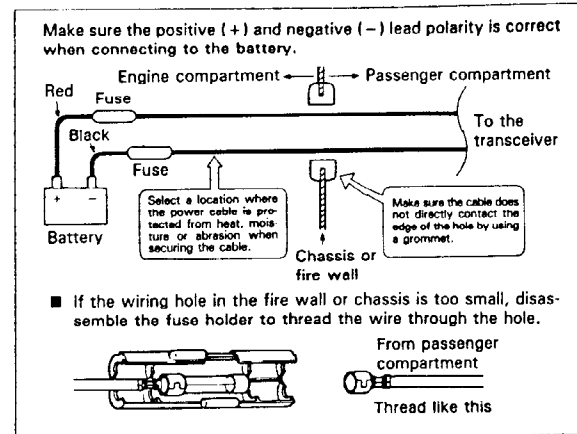

B. Ignition Noise

This transceiver has been designed to suppress ignition noise; however, if excessive noise is present, it may be necessary to use suppressor spark plugs (with resistors).

4-2-2 fixed

A regulated
least 11 Amp

1. Never c
other co
2. Before c
sure to
and the
3. Observe
operate:
be corre
Red
Black

4-2-3 An

The type of
the transceiv
enable your
impedance i
8D-2V for t
the use of I
Match the ir
that the SV
transceiver v
to 1).
High SWR
lead to TVI i

4-2-2 fixed Station

A regulated DC power supply (13.8 VDC capable of supplying at least 11 Amperes) is required.

1. Never connect the AC power cable to the AC outlet until all other connections have been made.
2. Before connecting and disconnecting the power connector, be sure to turn OFF the POWER switches of both the transceiver and the DC power supply.
3. Observe polarity of the DC power cable. The transceiver operates on 13.8 VDC, negative ground. Battery polarity must be correct. The power cable is color coded:
Red → + (Positive polarity)
Black → - (Negative polarity)

4-2-3 Antenna

The type of antenna that is used will greatly affect the performance of the transceiver. Use a properly adjusted antenna, of good quality, to enable your transceiver to perform at its best. The antenna input impedance is 50 ohms. Use 50-ohm coaxial cable such as RG-8U or 8D-2V for this connection. If the antenna is far from the transceiver the use of low loss coaxial cable, such as RG-8U is recommended. Match the impedance of the coaxial cable and that of the antenna so that the SWR is less than 1.5 to 1. The protection circuit in the transceiver will activate if the SWR is particularly poor (greater than 3 to 1). High SWR values will cause the transmitter output to drop, and may lead to TVI or BCI reports.

Caution:

We recommend that you install a high quality lightning arrester in your antenna lines for protection against fire, electric shock, personal injury, or damage to the radio itself.

5 OPERATION

5-1-1 CONTROL FUNCTIONS

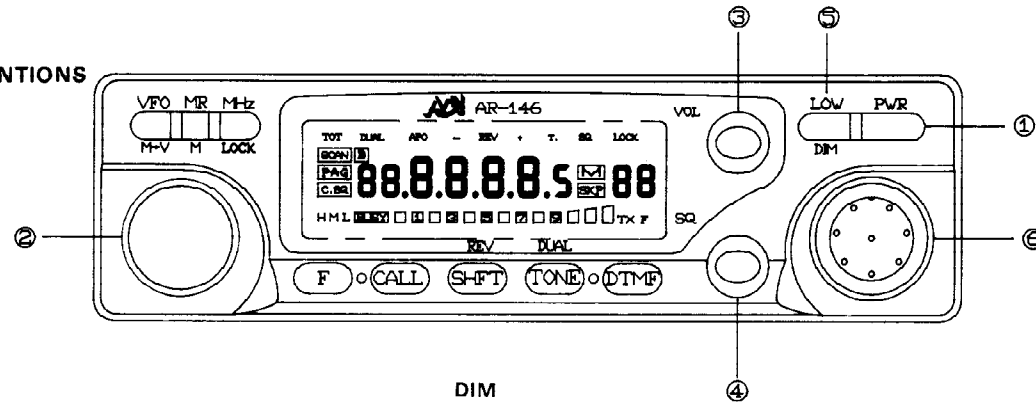

① POWER switch

Press to turn the transceiver on or off.

Press the VFO/M▶V or MR/M key and switching the power on will reset the VFO or MEMORY.

② Tuning control

This control is used to select the desired transmitter/receiver frequency, MHz step, memory channel, frequency step, tone frequency, scan direction, etc.

③ VOL control

This control is used to adjust the volume from the internal and external speaker (if used). Clockwise rotation will increase the volume and counterclockwise rotation will decrease the volume.

④ SQ (Squelch) control

This control is used to select the desired squelch threshold level.

⑤ LOW/DIM key

LOW

This function is used to select the transmit output power level (HI, MID or LOW)

DIM

This function is used to select the intensity of the front panel display illumination.

Pressing the F key for longer than 1 second and then press the LOW/DIM key while the F indicator is flashing will turn the time-out timer function on and off.

⑥ Microphone connector

Attach the supplied microphone to this connector. The pin out of the connector is shown in the accompanying illustration.

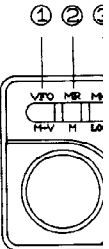
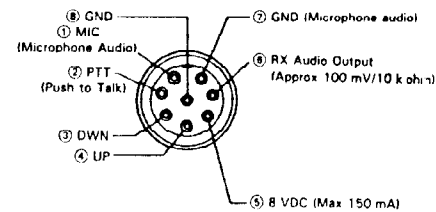

① VFO/M▶V
This key is used to select MR or CALL control at operating

Press and scan. Press to stop.

Pressing the memory key you to changing

Pressing VFO key

If you press destroy in

② MR/M▶V
This key

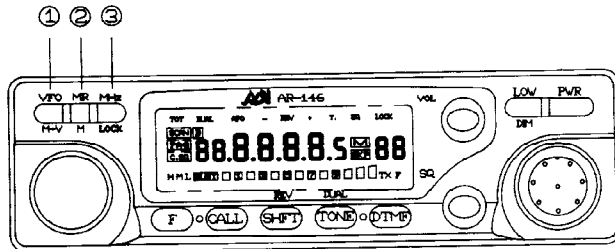

① **VFO/M ► V key**

This key is used to return to VFO operation after operating in the MR or CALL channel mode. Pressing this key will allow the tuning control and microphone UP/DN keys to increase or decrease the operating frequency.

Press and hold the key for longer than 1 second to initiate VFO scan. Pressing the key after scan has been initiated will cause scan to stop.

Pressing the key within 10 seconds of pressing the F key will copy the memory channel or call channel data to the VFO. This allows you to change parameters of that channel without actually changing the data that has been stored in memory.

Pressing the F key for longer than 1 second and then pressing the VFO key will allow you to set the offset frequency.

If you press and hold the VFO key while you turn on the POWER switch you will reset the microprocessor's VFO memory, without destroying the memory channel or call channel data.(VFO Reset)

② **MR/M key**

This key is used to select MR (Memory Recall) mode from the VFO

mode. The tuning control can then be used to select the desired Memory channel.

Pressing the key for longer than 1 second will initiate memory channel scanning.

Pressing the key within 10 seconds of pressing the F key will store the displayed data into memory.

In the MR channel mode pressing the F key for longer than 1 second and then pressing the MR key will cause the Memory channel to skip during Memory channel scan mode.

If you hold and press this key while you turn on the POWER switch you will clear all the microprocessor's operator programmed memory section.(system Reset)

③ **MHz/LOCK key**

This key is used to tell the microprocessor that you wish to increase or decrease the operating frequency in 1 MHz increment.

Pressing this key within 10 seconds of pressing the F key will cause the key lock function to activate, protecting the currently displayed data from accidental erasure.

Pressing the F key for longer than 1 second and then pressing MHz/LOCK key while the F indicator is flashing will turn the AUTOMATIC POWER OFF function on or off.

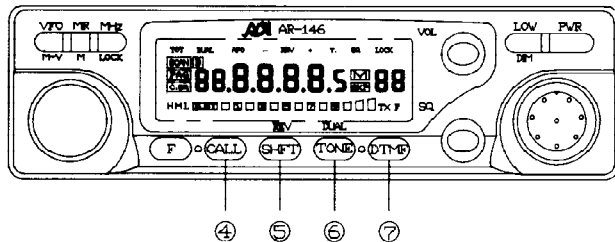

④ CALL key

Press this key to activate the call channel function. Press the F key momentarily and then press the CALL key to store the currently displayed data into the CALL channel. The radio will allow you up to 10 seconds to press the CALL key after pressing the F key. Pressing the F key for longer than 1 second and then pressing the CALL key will Enable/Disable the programming scan mode. Press the key within 10 seconds of pressing the F key while PAG/CSQ is active will allow you to change the delay time.

⑤ SHFT/REV key
SHIFT function

Pressing this key alone to select the desired transmitter offset direction. Pressing the key will cause the radio to shift from one offset direction to the next, i.e. " - " to " + " to simplex where no indicator shows.

REV function

Pressing this key within 10 seconds of pressing the F key will reverse the transmit/receive frequencies during repeater operation. If you have selected simplex this key will not function! Pressing the F key for longer than 1 second and then the SHFT/REV key will allow you to select the desired VFO tuning step

and Scan step size. Use the tuning control to select the desired tuning step and then press any front panel key except the POWER switch to return to the normal frequency display.

⑥ TONE/DUAL key

TONE function

Pressing this key by itself causes the radio to select the desired tone signaling mode. When the " T " indicator is illuminated in the display the transceiver will transmit the selected subaudible tone. When the " T.SQ " indicator is illuminated the transceiver will both transmit the subaudible tone and will also remain squelched until the proper subaudible tone is received.

TONE frequency selection

Pressing the F key for longer than 1 second and then pressing the TONE/DUAL key will allow you to select the desired tone frequency. To change to a different tone frequency rotate the tuning control or press the UP/DN switches on the microphone until the desired tone frequency appears in the display. To return to the normal frequency display you can press any front panel key except the power switch.

DUAL function

If you press the F key momentarily and then press the TONE/DUAL key, DUAL function will be activated.

This function allows you to watch two different frequencies. The Transceiver is capable of following types of dual-watch operation.

- (1) Listen on the dial-frequency and the memory frequency under M1.
- (2) Listen on the dial-frequency and one of the memory frequencies.
- (3) Listen on the dial-frequency and a memory frequency under scanning.

- ⑦ DTMF k
- Pressing
- DTMF B
- Pressing
- DTMF ki

5-1-2 L

- ③-
- ②-
- ④-
- ⑤-
- ⑥-

- ①TOT
- ②SCAN

- ③B
- ④PAG
- ⑥C.SQ
- ⑥HML
- ⑦ **BUSY**
- ⑧

- ⑨TX
- ⑩F

⑦DTMF key

Pressing this key alone to select the PAG, CSQ function if the DTMF Board is installed. Otherwise, a BU-sound will be generated. Pressing the F key for longer than 1 second and then pressing the DTMF key will turn the BEEP function Off or ON.

5-1-2 LCD Display Panel

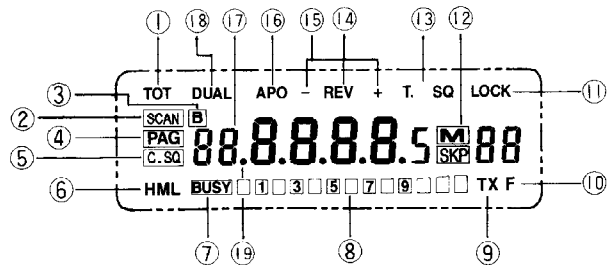

- ①TOT On when the Time Out Timer function has been activate.
- ②SCAN On when the VFO/MR SCAN function has been activated.
- ③B On when the Busy SCAN flag is active.
- ④PAG On when the DTMF PAGING function is active.
- ⑤C.SQ On when the code squelch function has been activated.
- ⑥HML Indicates the relative output power setting for transmit.
- ⑦ **BUSY** On when the squelch opens.
- ⑧ This level meter indicates the relative receiver signal strength or the relative transmitter power output.
- ⑨TX On during transmit.
- ⑩F On whenever the F key has been depressed. Also shows the last memory channel number that had been selected.

⑪LOCK

On when the Lock function has been activated.

⑫ **M 88**

Indicates the active memory channel number. SKP indicates that the channel is locked out.

⑬T.SQ

On when the Tone Decode and Encode function has been activated.

On when the Tone Encode function has been activated.

⑭REV

On when the Reverse function has been activated.

⑮ - +

Display the selected transmitter Offset direction.

Both - and + light at the same time during split channel operation.

⑯APO

On when the Automatic Power Off function has been activated.

⑰

Displays the operating frequency to the nearest kHz digit; or the tone frequency etc.

88.8888.5

The indicator flashes when scanning.

⑱ DUAL

On when DUAL-watch function is active.

⑲ •

On when unlock in TX mode, flash when Unlock in Rx mode.

5-1-3 Rear Panel

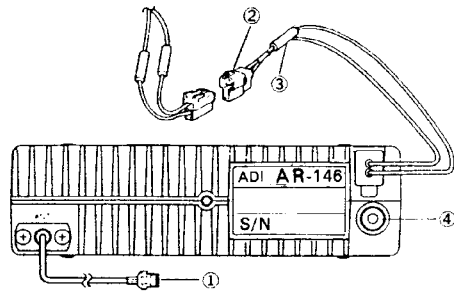

① ANTENNA connector

Attach an antenna with a low SWR and an impedance of 50 ohms.

② 13.8 VDC power input connector

Connect the supplied DC power cable to this connector.

Pay close attention to the polarity. Red is positive and black is negative.

③ Fuse holder

Contains a required fuse.

AR-146:15A, AR-446:10A

Do not use a larger fuse as damage might result to the transceiver.

④ External speaker jack

This jack is used to connect an external speaker. The speaker should have an impedance of 8 ohms.

5-1-4 Microphone

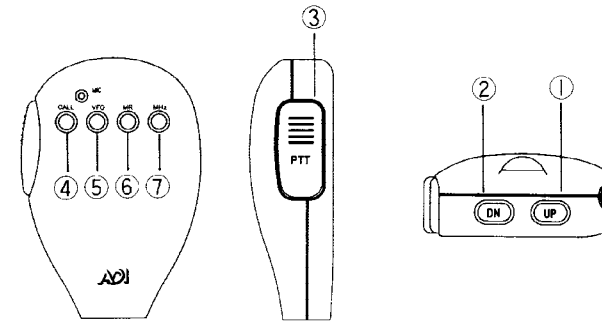

①② Up/DOWN switches

These switches can be used to increase or decrease the VFO frequency, the Memory channel number, and the Tone frequency, etc..

③ PTT(push to Talk) switch

The transceiver will transmit whenever this switch is depressed. Scan operations may be canceled by pressing this switch.

④ CALL key

This key functions just like the CALL key on the front of the radio.

1750 key

The transceiver will transmit with 1750 Hz repeater access tone whenever this switch is depressed in Tx mode.

⑤ VFO key

This key f

⑥ MR key

This key f

⑦ MHz key

This key is
or decreas

⑧ 16-Tone

These but

⑨ LOCK ke

This key ,

PTT funct

⑤ **VFO key**

This key functions just like the VFO key on the front of the radio.

⑥ **MR key**

This key functions just like the MR key on the front of the radio.

⑦ **MHz key**

This key is used to tell the microprocessor that you wish to increase or decrease the operating frequency in 1 MHz increments.

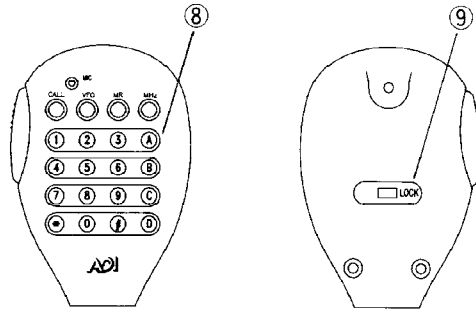

⑧ **16-Tone DTMF keypad**

These buttons are used to activate the DTMF encoder.

⑨ **LOCK key**

This key will deactivate all functions of the microphone except the PTT function and DTMF key pad.

5-2 RECEIVER OPERATIONS

Audio confirmation is provided whenever a front panel key is depressed. You can disable this function by pressing the F key for longer than 1 second and then pressing the DTMF key.

5-2-1 Reception

1. Connect the power supply, antenna, and microphone and then adjust the controls as follows:
 - Power Switch OFF
 - Vol Control Full Counterclockwise
 - Power switch of power supply (Fixed station)..... OFF
 - SQ Control..... Full Counterclockwise
2. Turn on the Power Supply and then turn on the transceivers POWER switch. The display should indicate a frequency. Fig.1 shows examples of frequencies that will appear on the various models. In addition to the frequency you may see one or more control indicators illuminates on the display.



Fig 1.

Note

The frequencies shown above are the default frequencies after a microprocessor reset. If the display shows incomplete data or you think the displayed frequency is in error you should reset the Microprocessor. The 10MHz digit “. ” Will flash if PLL is unlocked.

3. Rotate the VOL control clockwise until a signal or noise is heard coming from the speaker.
4. Rotate the tuning control or press the microphone UP/DN switches to select an open channel. Then rotate the SQ control clockwise until the noise just disappears and the BUSY indicator turns off. This point is known as the Squelch Threshold point. The squelch control must be adjusted to this setting for the Scan functions to operate properly.
5. Select the desired operating frequency using the microphone or tuning control. When a signal is received the S-meter will deflect and the BUSY indicator will turn ON.

Caution

Turn off the transceivers POWER switch before you start or stop your vehicles engine, or your home power supply.

5-2-2 Frequency Selection

You can change the dial frequency while in the VFO mode. The frequency can then also be stored in memory, or in the call channel using the techniques that will be described in this manual.

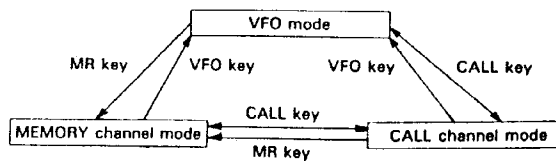

● VFO Mode Operation Frequency Selection

1. Press the VFO/M key to select the VFO mode.
2. Rotate the tuning control or press the microphone UP/DN switches to select the desired frequency.

● Memory Channel Selection

1. Press the MR/M key.
2. Rotate the tuning control or press the microphone UP/DN switches to select the desired memory channel.

● CALL Channel Selection

Press the CALL key to select the Call channel.

5-2-3 Frequency Step Selection

The frequency step is indicated in the chart below.

Channel step	5	10	12.5	15	20	25	50
--------------	---	----	------	----	----	----	----

To select the desired tuning or scan step size use the following procedure:

1. Press the
2. Press the light in t
3. Press the The curre

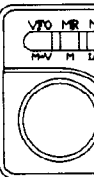

4. Rotate the microphc display.
5. To comp key on tl seconds normal fr

5-3 TR

Caution

1. Ensure (SWR) to tran damag
2. Always transm

1. Press the VFO/M►V Key to select the VFO mode.
2. Press the F key for longer than 1 second. The F indicator should light in the display.
3. Press the SHFT/REV key within 10 seconds of pressing the F key. The current frequency step size will be displayed.

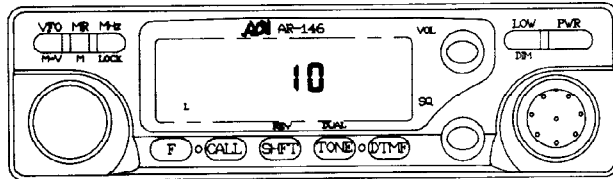

4. Rotate the tuning control or press the UP/DN switches on the microphone until the desired tuning step size appears in the display.
5. To complete the programming of the step size you can press any key on the front panel except the POWER key, or simply wait 10 seconds and the microprocessor will automatically return to the normal frequency display.

5-3 TRANSMITTER OPERATION

Caution

1. Ensure that an antenna with a low standing wave ration (SWR) is attached to the antenna connector before attempting to transmit. Failure to provide proper termination may result in damage to the final amplifier section.
2. Always check to ensure the frequency is clear before transmitting.

Note

The use of LOW power is recommended whenever possible, to avoid interfering with other stations.

5-3-1 Transmit Basics

1. Select the desired operating frequency using any of the methods previously discussed.
2. Press the LOW/DIM key to select the desired transmit output.

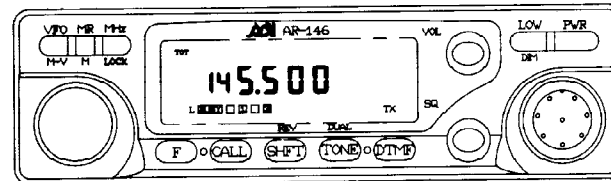

3. Check the frequency to see if it is occupied before you transmit.
 4. Press the PTT switch. The TX indicator will light, and the RF meter will deflect to the right. If you have selected the LOW power position, the indicator will appear in the display and the RF meter will only deflect slightly. When HI power has been selected the RF meter will deflect full scale.
 5. Speak into the microphone. The recommended distance to the microphone is 5 cm (2 inches).
- ※A " OFF " will appear on the display if TX frequency is out of the Range.

5-3-2 Time-out Timer (TOT)

The TOT can limit the continuous transmission time to 30 minutes.

1. Press the F key for longer than 1 second, then press the LOW/DIM key. The TOT indicator will light. To cancel the setting, repeat the operation.

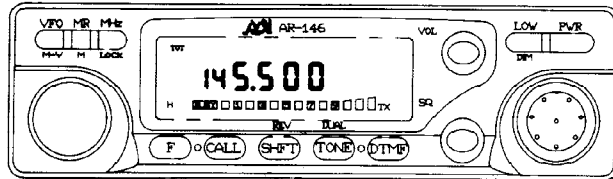

2. When the time-out timer reaches the transmission time limit the transceiver will return to the receive mode. To transmit again, release the PTT switch and press it again.

5-4 MEMORY

5-4-1 Microprocessor Memory Back-up

This transceiver contains a EEPROM to retain 40 memory channels.

5-4-2 Initial State

Initial state of the microprocessor from the factory is shown in the chart below.

	AR-146	AR-446
VFO Memory channel 1 CALL channel frequency	145.000 MHz	433.000 MHz
VFO step	10kHz	10kHz
Memory channel	1CH	1CH
Tone frequency	88.5Hz	88.5Hz

5-4-3 Microprocessor Initialization

● Memory channel Initialization (System Reset)

When you want to erase all programmed data or if the display shows erroneous information, you should initialize (reset) the microprocessor using the following procedure.

1. Turn the POWER switch off.
2. Press and hold the MR/M key and turn on the POWER switch.
3. Release the MR/M key.

● VFO Initialization (VFO Reset)

All the settings, except the contents of the memory and call channels, are initialized.

1. Turn the power switch off.
2. Press and Hold the VFO/M▶V key then turn the power switch on.

No transmit/receive operation occurs when this is done.

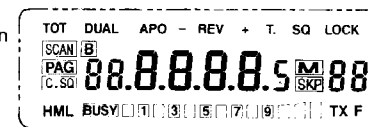

3. Press the VFO/M▶V key again.

5-4-4 Me

This transceiver In addition to Memory Cha

The functions

- Memory (WATCH f
- Memory Programm
- Memory Programm

5-4-5 Me

- Simplex/t
- 1. Press the)

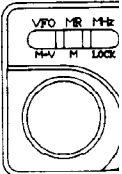

2. Select the (For exam

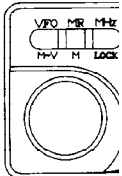

5-4-4 Memory Channel

This transceiver provides 40 Memory Channels.

In addition to serving as a normal Memory Channel some of the Memory Channels serve a dual purpose to specify other parameters. The functions of those Memory Channels are described below.

- Memory Channel 1 is used to store the frequency for the DUAL-WATCH function.
- Memory Channel 11 is used to store the lower limit for the Programmable Band Scan function.
- Memory Channel 12 is used to store the upper limit for the Programmable Band Scan function.

5-4-5 Memory Entry

- Simplex/Normal shift

1. Press the VFO/M \blacktriangleright V key to select the VFO mode.

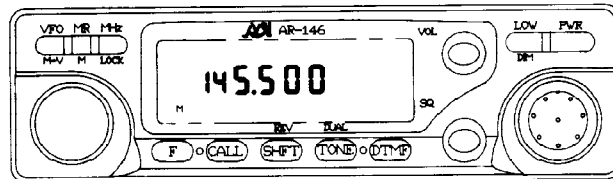

2. Select the desired operating frequency, offset, tone frequency, etc. (For example 145.500MHz)

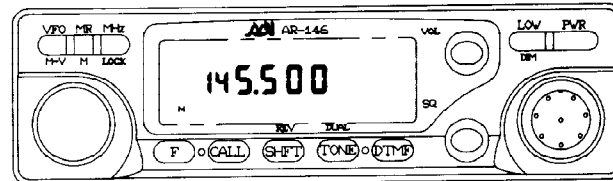

3. Press the F key. The F indicator and a memory channel indicator will light. (For example CH8)

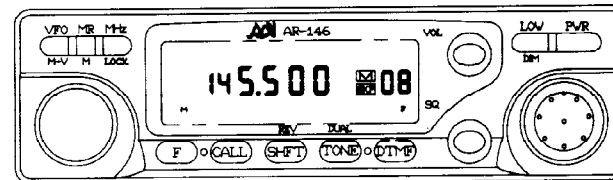

4. Select the desired Memory Channel using the Tuning Control or microphone UP/DN switches. (For example CH5)

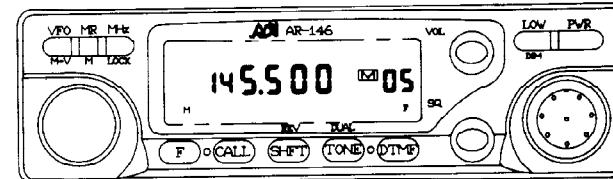

5. Press the MR/M Key within 10 seconds of selecting the Memory Channel. A long beep will sound and the F indicator and the Memory Channel number will turn on and the transceiver will change into the Memory mode.

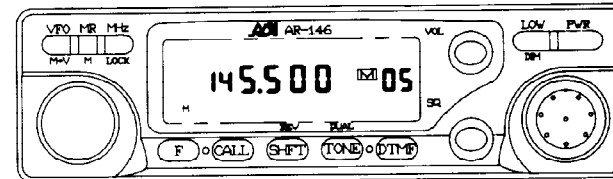

● CALL Channel

1. Press the VFO/M▶V key to select the VFO mode.
2. Select the desired operating frequency, offset, tone frequency, etc.
(For example 145,500 MHz)

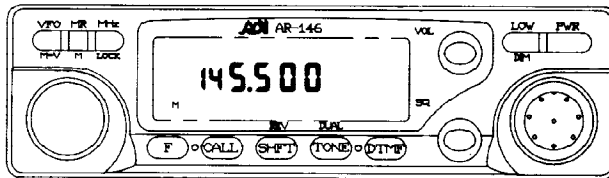

3. Press the F key. The F indicator and the memory channel indicator will light. (For example CH8)

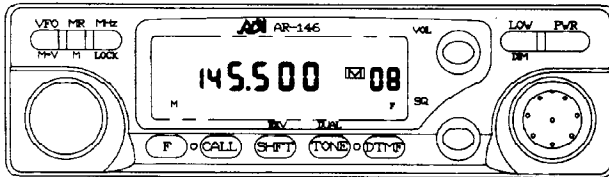

4. Press the CALL key within 10 seconds of pressing the F key. The F indicator and the Memory Channel number will turn OFF, to confirm data entry.

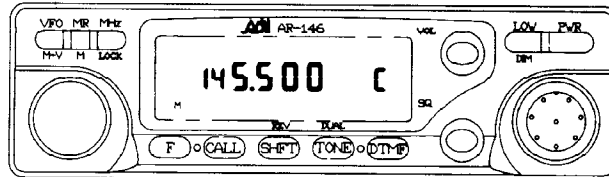

5-4-6 Memory Channel Recall

1. Press the MR/M key.
2. Rotate the tuning control or press the microphone UP/DN switches to select the desired memory channel.

5-4-7 Memory Shift

This feature copies Memory Channel or Call channel data to the VFO. This will allow you to recall and alter these frequencies without changing the actual contents of the memory or CALL channel.

1. Press the MR/M key or CALL key to select the MR mode or CALL channel mode.
2. Press the F key. The F indicator will light.
3. Press the VFO/M▶V key within 10 seconds of pressing the F key. The F indicator and the Memory or CALL Channel indicator will turn OFF to signal the data has been successfully transferred to the VFO.

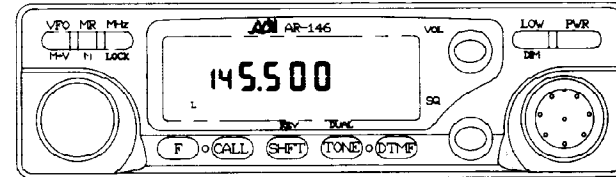

5-5 SCAN

When the scan indicate the scan

5-5-1 Scan

The following

1. Band scan
Scan proceed in VFO mode
2. Programme
The scan proceed in Memory VFO mode
3. Memory channel
Scan proceed in data entered in the Memory

5-5-2 Hold

The transceiver Two type of s

- Time operated
Scan will stop when station is silent
- Carrier operated
Scan will stop when scan 3 seconds

5-5 SCAN

When the scan function is turned on the SCAN indicator will light to indicate the scanning mode.

5-5-1 Scan Operation

The following scan options are available:

1. Band scan
Scan proceeds over the entire band (This function operates in the VFO mode only).
2. Programmable band scan
The scan frequency range is determined by the frequencies stored in Memory Channels 11 and 12 (This function operates in the VFO mode only).
3. Memory channel scan
Scan proceeds through those memory channels that actually have data entered and have not been locked out (This function operates in the Memory Channel mode only.).

5-5-2 Hold/Resume Programming

The transceiver will stop on a busy channel.
Two type of scan hold/resume have been provided in this transceiver.

- Time operated scan (pause scan)
Scan will resume approximately 3 seconds after stop even if the station is still present.
- Carrier operated scan (Busy scan)
Scan will hold as long as the signal is present. and will resume scan 3 seconds after the signal drop out.

Note

When CTCSS is on, scanning stops only at the stations for which the CTCSS signal matches.

This transceiver is delivered from the factory in the Time operated scan mode. To switch between the two modes use the following procedure.

1. Press the F key for longer than 1 second. The F indicator will flash.
2. Within 10 seconds of pressing the F key press the F key. This will toggle the Scan/Resume mode to Carrier operated mode. And B indicator will be on.
3. To return to Time operated mode repeat steps 1 and 2.

5-5-3 Band Scan

1. Press the VFO/M▶V key to select the VFO mode.
2. Adjust the SQ control to the threshold point.
3. Press and hold the VFO/M▶V key for longer than 1 second.
The MHz indicator will flash as a visual reminder the transceiver is scanning.

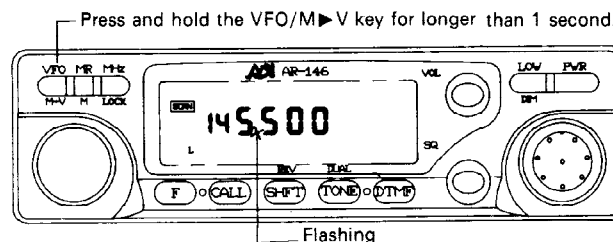

- Scan will begin at the same direction as last time. You can reverse the direction by rotating the Tuning control counterclockwise, or by pressing the microphone UP/DN switch. The scan step size depends upon the current step programming.
- Scan will stop whenever a signal is received (that activates the BUSY indicator) for a limited time.
- Press the PTT switch or any front panel key to stop scan.

5-5-4 Programmable Band Scan

- Press the F key for longer than 1 second and then pressing the CALL key to turn ON/OFF the programming scan mode.
- The lower scan limit must be stored in memory channel 11. The higher scan limit must be stored in memory channel 12.

Notes

If the frequency in Memory Channel 11 is equal to or greater than the frequency stored in Memory channel 12 scan will proceed over the entire band "Band Scan".

- Adjust the SQ control to the threshold point.
- Press the VFO/M▶V key to select the VFO mode.
- Select a VFO frequency between the two programmed scan limits.
- Press and hold the VFO/M▶V key for longer than 1 second. The MHz indicator will flash as a visual reminder the transceiver is scanning and SCAN is on.

Press and hold the VFO/M▶V key for longer than 1 second.

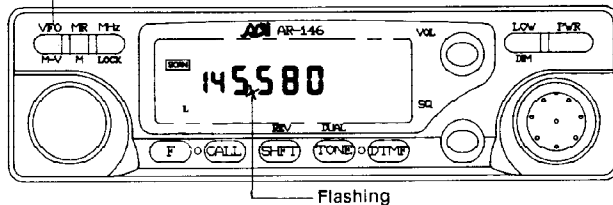

- Scan will begin at the same as last direction. You can reverse the direction by rotating the Tuning control counterclockwise, or by pressing the microphone DN switch.
- SCAN will stop whenever a signal is received (that activates the BUSY indicator) for a limited time.
- Press the PTT switch or any front panel key to stop scanning.

5-5-5 Memory Channel Scan

- Adjust the SQ control to the threshold point.
- Press and hold the MR/M key for longer than 1 second. The MHz indicator will flash and SCAN is on as a visual reminder the transceiver is scanning.

Press and hold the MR/M key for longer than 1 second.

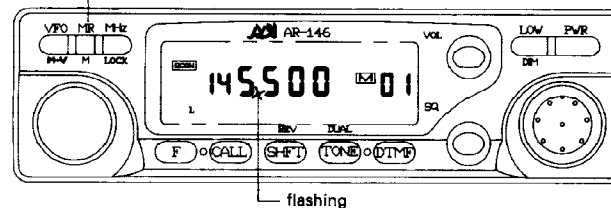

Notes

- The transceiver will not scan if there is only one memory channel.
 - The transceiver will skip any locked-out channels.
 - The transceiver will scan only the memory channels in which frequencies have been stored.
- Scan will begin at the current memory channel and proceed sequentially i.e. M1 → M2 → M3 etc. Only those memory channels with data entered are scanned.

- Scan will
- BUSY indi
- Press the l

5-5-6 Me

The Memory skip unwanted

- Press the l
- Select the Tuning co
- Press the flash. Witl key. A " number. T the Memo

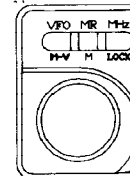

- Repeat ste you want
- To cancel described The " SK scanned n

4. Scan will stop whenever a signal is received (that activates the BUSY indicator) for a limited time.
5. Press the PTT switch or any front panel key to stop scanning.

5-5-6 Memory Channel Lockout

The Memory Channel Lockout function allows you to temporarily skip unwanted Memory Channels during Memory Channel scan.

1. Press the MR/M key to select the Memory Channel mode.
2. Select the Memory Channel that you wish to skip by using the Tuning control or the microphone UP/DN switches.
3. Press the F key for longer than 1 second. The F indicator will flash. Within 10 seconds of pressing the F key press the MR/M key. A "SKP" will appear to the left of the Memory Channel number. This indicates the Memory Channel will be skipped during the Memory Channel scan operation.

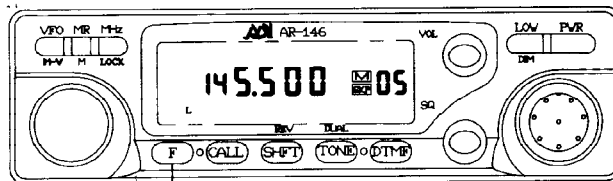

Press the key for longer than 1 second.

4. Repeat steps 2 and 3 to lock out any other Memory Channel that you want to skip.
5. To cancel the lockout, select the desired Memory Channels as described in step 1,2, and 3 above.
The "SKP" will go out. The Memory Channel will now be scanned normally.

5-6 Dual-Watch Operation

This function allows you to watch two different frequencies. The transceiver is capable of following types of dual-watch operation.

- (1) Listen on the dial-frequency and the memory frequency under M1.
- (2) Listen on the dial-frequency and one of the memory frequencies.
- (3) Listen on the dial-frequency and a memory frequency under scanning.

Information

- The word " DUAL " is indicated on the display during dual-watch operation.
- The dial-frequency can be changed during dual-watch operation.
- During dual-watch operation, the Transceiver listens on a memory frequency once every three seconds and instantaneously displays its frequency.
- Dual-watch operation pauses while the memory frequency is being received.
- When a signal is received on the dial-frequency during dual-watch operation, the signal will be heard interruptedly as the Transceiver leaves the dial-frequency once every three seconds.
- Rotate the squelch control full counterclockwise to pause the dualwatch operation with the memory frequency to listen.

NOTE:

- (1) During dual-watch operation, transmission is only available at the dial-frequency.
 - (2) Press the PTT button to transmit. The dial-frequency is displayed and you can transmit at the dial-frequency. Release the PTT button to return to dual-watch.
 - (3) When a signal is received at the memory frequency, release the dual-watch operation and recall the memory frequency for communication.
- Press the VFO/MR key will Release the DUAL-watch mode.

5-6-1 Dual-watch on the dial-frequency and the memory frequency under CH1.

1. Press the VFO/M▶V key to select the VFO mode.
2. Press the F key momentarily. The F indicator should light in the display.
3. Press the TONE/DUAL key within 10 seconds of pressing the F key. A " DUAL " will appear on the display to indicate the DUAL-watch operation.

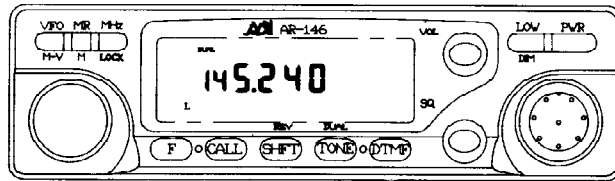

5-6-2 Dual-watch on the dial-frequency and a memory frequency.(or call frequency)

1. Recall a memory frequency you wish to use in the dual-watch function.
2. Press the F key momentarily. The F indicator should light in the display.
3. Press the TONE/DUAL key within 10 seconds of pressing the F key. A " DUAL " will appear on the display to indicate the DUAL-watch operation.

4. The display will alternately indicate the dial frequency and a select memory frequency.

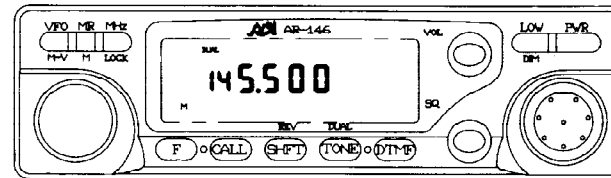

5-6-3 Dual-watch on the dial-frequency and a memory frequency under scanning in sequence.

1. Press and hold the MR/M key for longer than 1 second. The MHz indicator will flash as a visual reminder the transceiver is scanning.

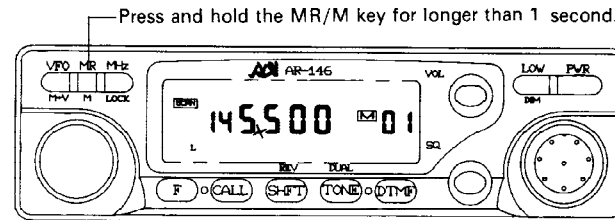

2. Press the POWER switch to turn OFF the transceiver.
3. Press and hold the TONE/DUAL key and turn on the POWER switch.

4. Release the display to The display memory f

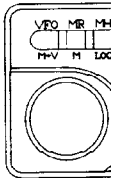

5-7 RE

5-7-1 Tr

All radio re
The receive
transmit fre
categories l

Offset Dir

To select th
key. Each 1
one directic

4. Release the TONE/DUAL key, A "DUAL" will appear on the display to indicate the DUAL-watch operation. The display will sequentially indicate the dial-frequency and the memory frequencies under scanning one by one.

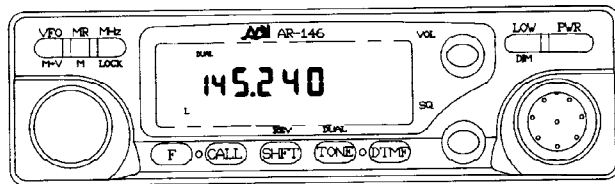

5-7 REPEATER OPERATIONS

5-7-1 Transmitter Offsets

All radio repeaters utilize a separate receive and transmit frequency. The receiver frequency may be either above or below that of the transmit frequency. The initial offset frequency will fall into one of the categories listed below:

	AR-146	AR-446
+	+600kHz	+5MHz
-	-600kHz	-5MHz

Offset Direction

To select the desired transmitter offset direction press the SHIFT/AL key. Each time you press the key the transceiver will advance from one direction to the next, i.e. "-" to "+".

To select the desired offset frequency use the following procedure:

1. Press the VFO/M▶V key to select the VFO mode.
2. Press the F key for longer than 1 second. The F indicator will begin to flash. Press the VFO/M▶V key within 10 seconds of pressing the F key. The current tone frequency will show in the display.

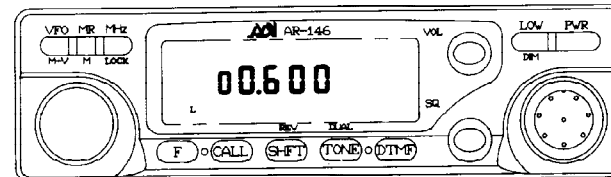

3. Rotate the tuning control or press the microphone UP/DN switches to select the desired offset frequency.
4. Press the VFO/M▶V key to select the VFO mode.

5-7-2 Reverse Function

Some repeaters utilize a "Reverse Pair", i.e. the transmit/receive frequencies are exactly the reverse of another repeater. For example repeater A uses 146.000 for a transmit frequency (INPUT) and 146.600 for a receiver frequency (OUTPUT). Repeater B might use 146.600 for a receiver frequency. It would be inconvenient to have to reprogram the transceiver each time you wanted to use these repeaters.

Press the F key momentarily. The F indicator should light in the display.

Press the SHFT/REV key within 10 seconds of pressing the F key. The REV function is active.

To return to normal press the SHFT/REV key again. The REV indicator will turn off.

This function is also useful to check the input frequency of the repeater so that you can determine if you are within range for simplex communications.

5-7-3 Tone Operation

Some repeaters require the use of a control signal to activate the repeater. Several different methods are currently in use.

In the United States sub-audible tones are sometimes used. 38 different Sub-audible frequencies are possible.

In Europe a 1750 Hz tone is used in transmit. Press and hold the PTT key to transmit, then press the Micro phone CALL key will generate a 1750 Hz tone.

5-7-4 Tone Frequency Selection

Press the F key for longer than 1 second. The F indicator will begin to flash. Press the TONE/DUAL key within 10 seconds of pressing the F key. The current tone frequency will show in the display.

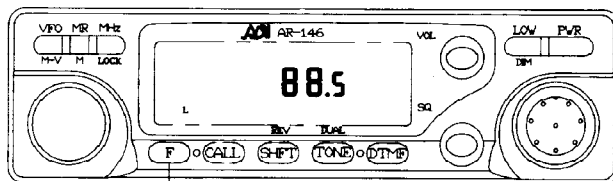

Press the key for longer than 1 second.

2. Rotate the Tuning control or press the microphone UP/DN switches to select the desired CTCSS tone frequency.
3. Press any front panel key to return to the normal frequency display.

Tone Frequency(Hz)

67.0	107.2	173.9
71.9	110.9	173.8
74.4	114.8	179.9
77.0	118.8	186.2
79.7	123.0	192.8
82.5	127.3	203.5
85.4	131.8	210.7
88.5	136.5	218.1
91.5	141.3	226.7
94.8	146.2	233.6
97.4	151.4	241.8
100.0	156.7	250.3
103.5	162.2	

5-8 TONE/CTCSS OPERATION

With the use of the optional Sub-Audible tone decoder unit (CTS146) you will be able to operate in a Tone Operated Squelch Mode. When this option is installed and the CTCSS function has been activated the radio will not open squelch until the proper TONE IS RECEIVED.

Press the TONE/DUAL key and select the desired Tone mode. When the T indicator appears in the display the transmitter will transmit the desired tone. When the T.SQ indicator appears in the display the transceiver will transmit the desired tone and will also operate in the Tone Squelch mode. i.e. squelch will not open until the same tone is

received as
indicator is

N

5-9 C.S [Re

This functio
reception of
your radio.
Once squel
operates no
than 3 seco
received.

received as a portion of the incoming receive signal. When no indicator is on the radio will not make use of either tone feature.

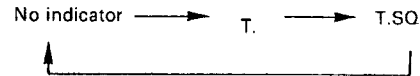

5-9 C.SQ(CODE Squelch System) OPERATION [Requires optional DTS146]

This function allows squelch to be turned on in the receive mode on reception of a three-digit code matching the C.SQ code selected in your radio.

Once squelch is turned on by reception of a matching code, it operates normally from then on. If no signal is received for longer than 3 seconds, squelch is turned off until a matching code is again received.

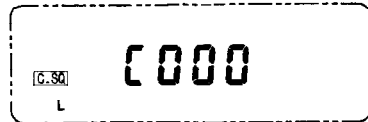

NOTE

C.SQ is also called as DTSS. (Dual TONE SQUELCH SYSTEM)

This function is not available in some areas.

The C.SQ (or PAGING) code may not be accepted if the repeater is "identifying". If this should occur you should press the PTT switch again, and retransmit the C.SQ (or PAGING) code.

There are two recommended methods of compensating for this situation.

1. Press the PTT switch for a few seconds, send the C.SQ (or PAGING) code release the PTT switch, then press the PTT switch again and resend the appropriate code.
2. Proper C.SQ (or PAGING) operation will occur if you ensure the battery saver circuit is disabled whenever you intend to operate using either the C.SQ or PAGING modes.

5-9-1 Selecting and Storing the C.SQ code

C.SQ codes from 000 through 999 can be selected from the VFO mode and stored in memory channels.

5-9-2 C.SQ Code Selection

When DTMF unit DTF146 [option] is installed, the initial setting is 000.

- **Selecting and Storing the C.SQ code with the VFO**
1. Press the DTMF key twice to light the C.SQ indicator.
 2. Press the F key, then press the DTMF key while the F indicator is on (10 seconds). The first digit of the C.SQ code will flash.

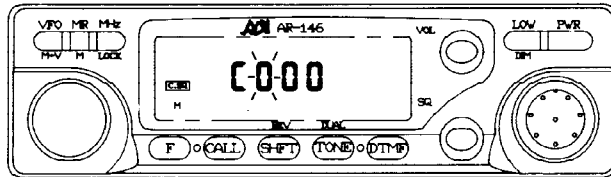

3. Select the first digit by rotating the Tuning control.
 4. Press the DTMF key. The first digit is registered and the second digit begins to flash.
 5. Select the second digit by rotating the Tuning control.
 6. Press the DTMF key. The second digit is registered and the third digit begins to flash.
 7. Select the third digit by rotating the Tuning control.
 8. Press the F key and the complete C.SQ code is registered. The mode returns to the previous one.
- **Selecting and storing a code with the DTMF KEY PAD (MIC 146 D)**
1. Press the DTMF key twice to light the C.SQ indicator.
 2. Press the F key, then press the DTMF key while the F indicator is on (10 seconds). The C.SQ code setting mode will be entered and the first digit of the code will flash.
 3. Then enter a three-digit number on the key pad.

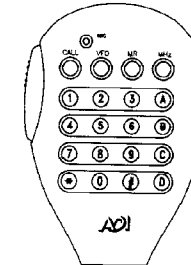

Notes

1. If a key other than the DTMF key on the front panel is pressed during operation, code selection mode is canceled.
2. If no action is taken for longer than 10 seconds, code selection mode is automatically canceled.
3. If the optional DTF 146 is not installed, a Bu-sound will be generated each time you press the DTMF key.

5-9-3 Using the C.SQ function

1. Adjust the SQL control to the threshold point.
2. Press the DTMF key. The C.SQ indicator will light. Each time the DTMF key is pressed, the PAG and C.SQ functions will be selected:

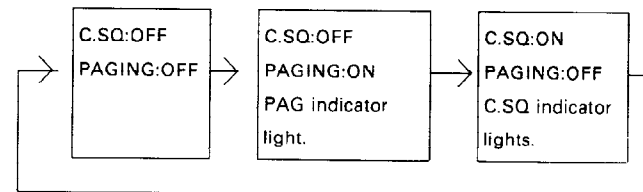

- **RECEP**
- 3. Squelch
- **TRANS**
- 4. When th sent out

Note

Voice out

5. To cancel

5-9-4 U

The C.SQ s pressed w malfunction with long r

- **Delay**
- A delay is l
- The dela
- The initi
- can be c

- **Chang**
- 1. Turn C.:

● **RECEPTION**

3. Squelch will open when the proper code is received.

● **TRANSMISSION**

4. When the PTT switch is pressed, the code shown in the figure is sent out for about 0.5 second.

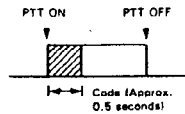

Note

Voice output is muted during code output.

5. To cancel the C.SQ function press the DTMF key.

5-9-4 Using C.SQ with a repeater

The C.SQ signal is transmitted after a short delay if the PTT switch is pressed while the - or + indicator is lit. This is to avoid any malfunction due to the C.SQ signal being interrupted by repeaters with long response times.

● **Delay during C.SQ or PAG output**

A delay is built in when the C.SQ or PAG is sent out.

The delay time for normal transmission is 250 ms (not modifiable).

The initial setting for shift, split channel, and duplex is 450 ms, and can be changed to 750, 850, or 1000 ms.

● **Changing the delay time**

1. Turn C.SQ mode on.

2. To change delay time press the F key momentarily and then press the CALL key within the 10 seconds.

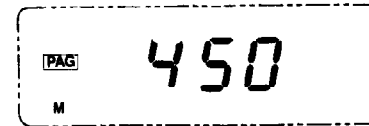

3. Display the desired delay time with the tuning control or the UP/DN key on the microphone. The displayed delay time takes effect immediately. If any other key is pressed or if, after 10 seconds, no key has been pressed, the delay time setting mode is terminate.

5-10 PAGING

The paging function is available when the optional DTMF unit (DTF146) is installed.

The paging function is useful to call all station a group, a specific station, or wait for a call from another station by using DTMF (Dual Tone Multi Frequency signaling).

Example: When station 2 is called

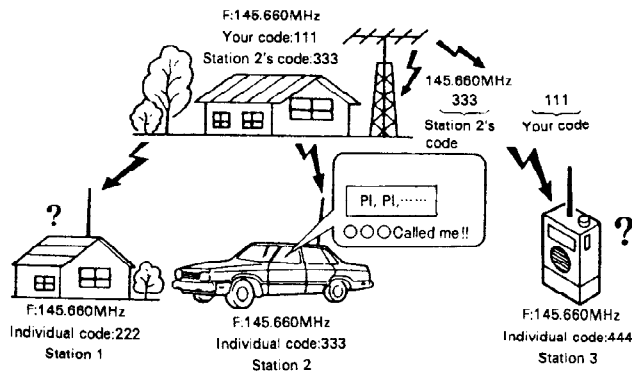

The common group code and individual codes should be determined in advance. These codes should be from 000 to 999 (3 digits). Unlike C.S.Q, the code of the calling station is displayed on the receiver, so the receiver can identify the calling station.

When called by a local station, the individual code of the calling station is displayed. When called with a group code, that group code is displayed.

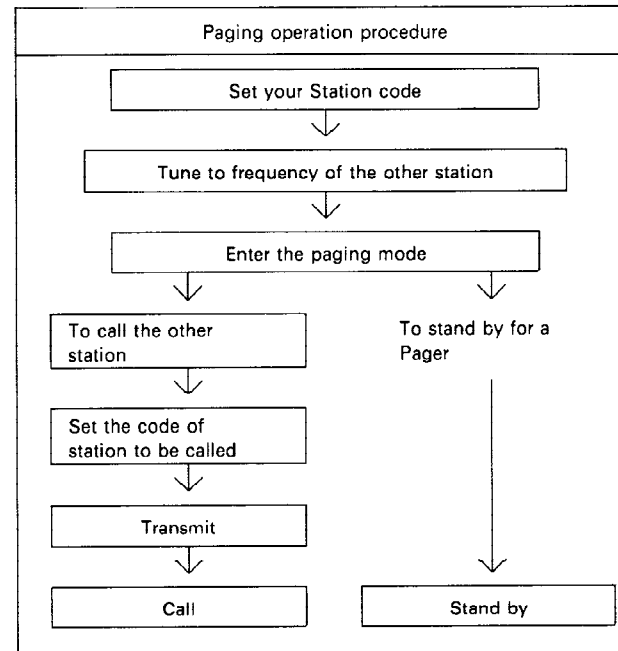

5-10-1 P

There are five

PA
P0
P1~P

5-10-2 S

1. Press the will light.
2. Press the on. The channel i

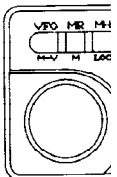

5-10-1 Paging Code Memories

There are five(5) paging code memories.

	Use
PA	Store your individual ID code in memory.
P0	Automatically stores the calling station's code during reception. Can temporarily set code for the station.
P1~P3	Stores group codes and local station codes in memory.

5-10-2 Setting the Paging Codes

1. Press the DTME key to enter the paging mode. The PAG indicator will light.
2. Press the F key, then press the DTMF key while the F indicator is on. The code setting mode will be entered and the memory channel indicator will flash.

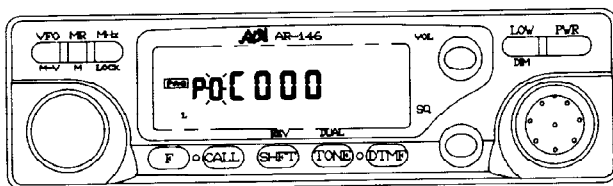

3. Set the desired memory (0 to 3 or A) with the tuning control (or key 0 to 3 or A on the microphone [option] with DTMF).
4. Press the DTMF key. The first digit will flash.
(Not necessary this operation if you use DTMF microphone)

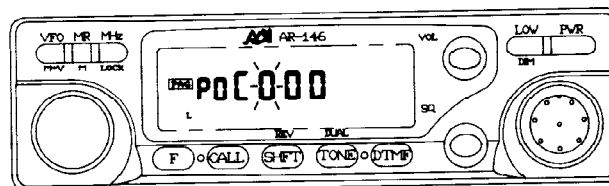

5. Set the desired number with the tuning control and press the DTMF key (or key 0 to 9 on the microphone with DTMF). The first digit will be set, and the second digit will flash.

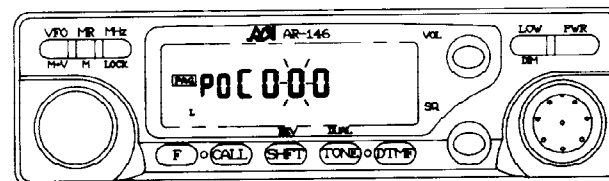

6. Set the second and third digits with the tuning control, and press the DTMF key.
7. If, after 10 seconds, no key has been pressed, or a key other than DTMF is pressed, the code will be set.

For example, the following groups communicate with each other.
 Predetermined frequency 145.660MHz
 Your individual code 111
 Station 1's individual code 222
 Station 2's individual code 333
 Station 3's individual code 444
 Group code 789

Your memory
 PA 111
 P0
 P1
 P2 444
 P3 789

Station 1 memory
 PA 222
 P0
 P2 789

Station 2 memory
 PA 333
 P0
 P3 789

Station 3 memory
 PA 444
 P0
 P1 789
 P2 111

5-10-3 Paging Transmission (Calling)

Your individual ID code is preset in memory A.(Your individual ID code is always stored in memory A.)

1. Tune to the predetermined frequency.
2. Press the DTMF key to light the PAG indicator.

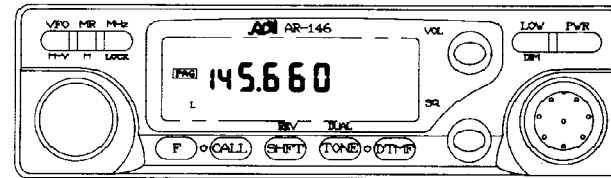

3. Press the F key, then press the DTMF key while the F indicator is on.

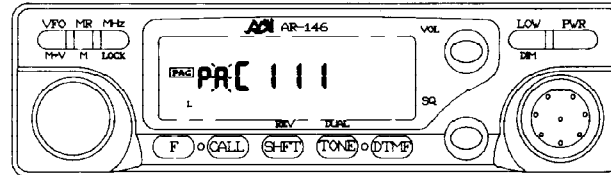

4. Select the memory number in which the local station code is stored using the tuning control. Turn the paging function of the other transceiver on.

Calling all station in the group

1. To call all which the stored in nu
2. Press the P the frequen
3. Press the P

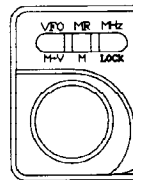

Group code
 DTMF tone s

Cal

- To call a following p
1. Select th this exar of the lo
 2. Press th display t
 3. Press th

1. To call all station in the group, select the memory number in which the group code is stored. In this example, the number is stored in number P3.
2. Press the PTT key once or press a key other than DTMF to display the frequency again.
3. Press the PTT switch.

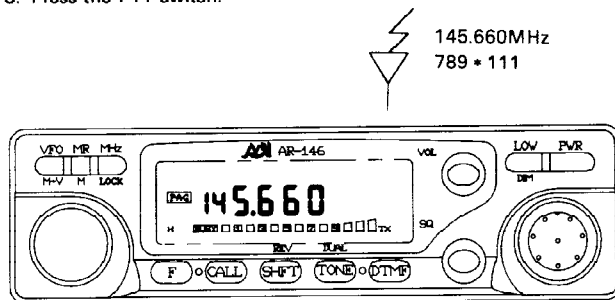

Group code 789 and your station ID code 111 are transmitted. A DTMF tone sounds is heard during transmitting.

Calling a specific station (Example:Call station 3.)

To call a specific station (for example, station 0.3), use the following procedure:

1. Select the memory in which the local station code is stored (in this example, select memory P2.) or Enter the individual code of the local station in memory 0.
2. Press the PTT key once or press a key other than DTMF key to display the frequency again.
3. Press the PTT switch.

145.660MHz
444 * 111

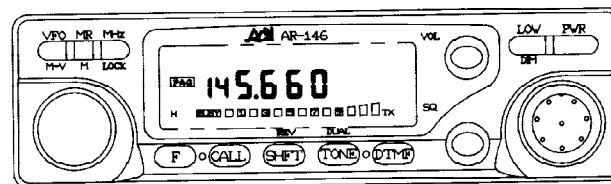

Local station code 444 and your station ID code 111 are transmitted. A DTMF tone sounds is heard during transmitting.

5-10-4 Paging Reception (Stand by)

1. Tune to the predetermined frequency.
2. Press the DTMF key to light the PAG indicator.

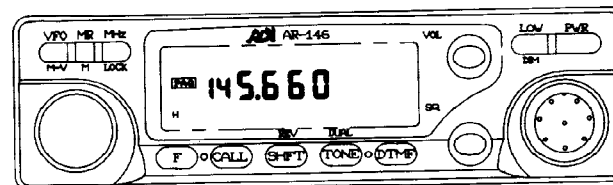

Stand by with individual code (Example:Stand by for station 3.)

3. When called with your station ID code, the memory number automatically change to 0. The ID code of the member 3 is displayed.

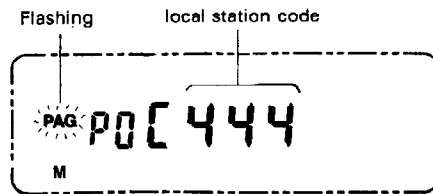

4. The squelch is opened.
5. The individual code of the calling station is stored in memory 0. Press the PTT switch to respond to the calling station.

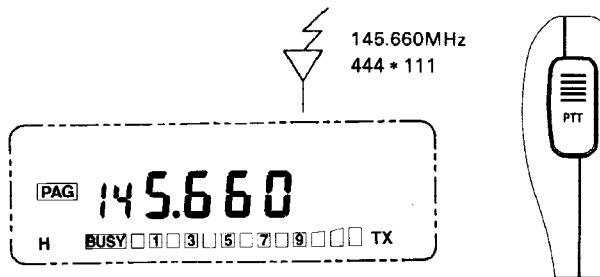

When the transmission ends, the frequency will be displayed again. After the local station has been contacted, cancel paging mode. Communication can be performed more efficiently.

If the local station code can not be decoded, "Err" appears on the display.

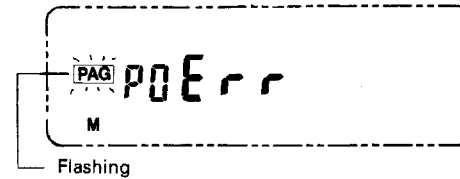

Stand by with group code

1. When a call is received with the group code, the squelches of all the members of the group are opened to enable reception.

When you are called with the group code, the common group code and its memory channel number are displayed. (Example: Group code 789 is stored in channel 3.)

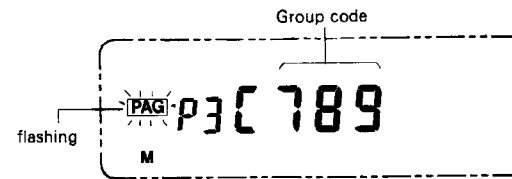

3 is displayed to indicate that the station is being called.

2. When the PTT switch is pressed, group code 789 (as displayed) and your station ID code are transmitted. You can participate in the group-roundtable.
3. After the remote station has been called, cancel paging mode. Communication can be performed more efficiently.

5-10-5 Co

(A code is function.)

If an individual when the code is another. To use memories. When you are same frequency temporarily stop

● Paging n

1. Enter the memory 0
2. Press the SKP mark

3. To cancel,

5-11 DT

The DTMF optional DTM The Decoding signal on the

5-10-5 Code Lockout

(A code is locked out only during reception with the paging function.)

If an individual code is stored in P1, P2 or P3, reception is enabled when the codes match, even if one local station communicates with another. To use memories P1 to P3 for transmission only, lock out the memories.

When you are communicating with two or more groups having the same frequency, lock out the group code with which stand by is temporarily stopped.

● Paging memory lockout

1. Enter the code setting mode and display the number (except memory 0 and A) to be locked out using the tuning control.
2. Press the MR/M key.
SKP mark lights and the memory is locked out.

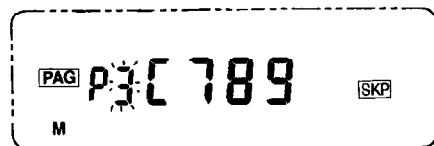

3. To cancel, repeat steps 1 and 2.

5-11 DTMF CODE DECODING FUNCTION

The DTMF CODE DECODING FUNCTION is available. When the optional DTMF UNIT (DTF146) is installed.

The Decoding Function is useful to display the Receiving DTMF signal on the LCD with 16 Digits Maximun.

5-11-1 Setting the CODE decoding mode

1. Press the DTMF key to return to normal mode (turn off the PAG, CSQ)
2. Press the F key. The F indicator will light.
3. Press the DTMF key within 10 seconds. It will enter into the DTMF code decoding mode.

The left 2 small digits represents the position of the Right 4th DTMF code position.

The Right 4 Big digits represents the contents of the Decoded DTMF codes.

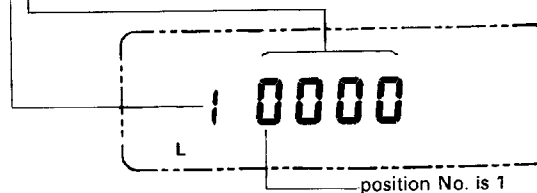

4. You can rotate the tuning control or press the microphone UP/DN switches to select the desired DTMF code position.

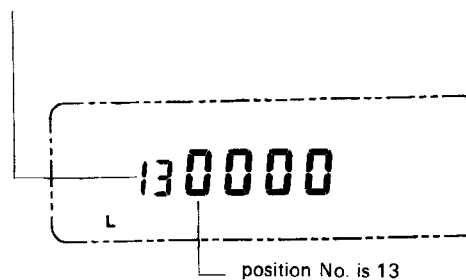

5. Or you can press the MHz/LOCK or the microphone MHz key to clear the content of DTMF codes.

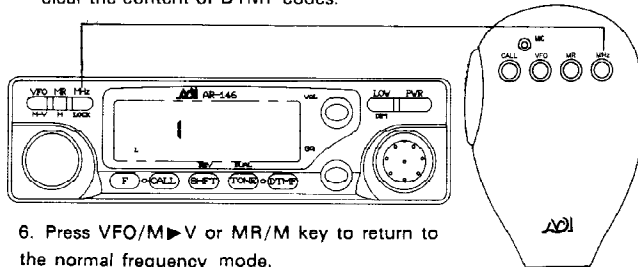

6. Press VFO/M▶V or MR/M key to return to the normal frequency mode.

5-11-2 Store the CODE Memory

You can keep the decoded code data even when you power-on next time if necessary.

The procedure is:

Press MR/M key to store the code data and a long PI- sound will be generated.

5-12 APO(Automatic Power Off)

The automatic power-off function turns the power off automatically if you forget.

The initial setting is OFF.

1. To turn the APO function off and on, press the F key for longer than 1 second, then MHz/LOCK key within 10 seconds. The APO indicator lights.
2. If, after 30 minutes in inactive receive mode, no key has been pressed, the APO indicator flashes and a beep sounds. After that all the functions are disabled, and the transceiver enters the automatic power-off state.

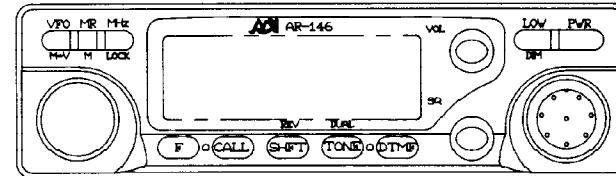

3. To leave the automatic power-off state, turn the power switch off and on again.

Notes

A small current flows during the automatic power off state. If the transceiver is not going to be used, be sure to switch the power off.

5-13 DIM(DIMMER)

The intensity of dial illumination can be set to one of four levels.

1. Press the F key, then press the LOW/DIM key while the F indicator lights.

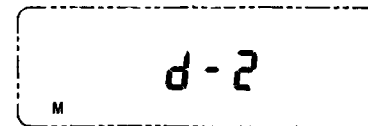

2. Select the desired value with the tuning control or the UP/DN key on the microphone.
3. If, after 10 seconds, no key has been pressed, the displayed level is set and the original frequency is redisplayed.

5-14 BE

The beep car

Press the F I
while the F i
Each time th

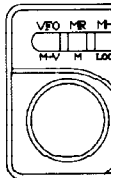

5-15 LO

There are tw

①Microphc
When the
position, a

5-14 BEEP

The beep can be turned on and off.

Press the F key for longer than 1 second, then press the DTMF key while the F indicator is flashing.

Each time this is done, the beep is turned on or off.

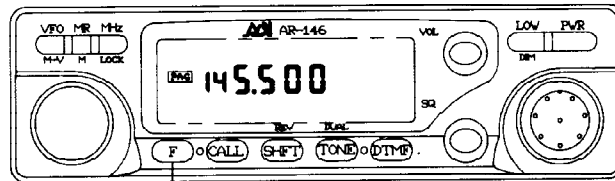

Press the key for longer than 1 second.

5-15 LOCK

There are two types of lock functions.

① Microphone key lock

When the switch on the rear of the microphone is set to the LOCK position, all the microphone keys except the PTT key are disabled.

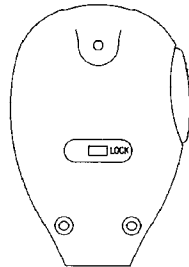

② LOCK

The panel keys (except F and MHz/LOCK key) and the tuning control are disabled. However, the microphone function works.

Press the F key, then press the MHz/LOCK key within 10 seconds. The LOCK indicator lights.

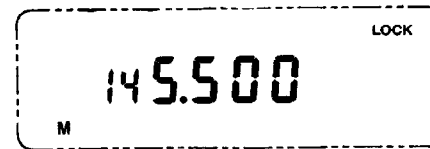

To release the lock, press the F key again, then press the MHz/LOCK key within 10 seconds.

5-16 Channelized Frequency Display

The frequency display can be changed to display channel numbers instead of the operating frequency. CH1 is memory channel 1, CH2 is memory channel 2, etc.

5-16-1 CHANNEL Display mode

1. Press the MR/M key to select the Memory channel mode.
2. Turn OFF the Transceiver by pressing the POWER switch.
3. Press both the PTT and CALL key of microphone, press the MHz/LOCK and hold these 3 keys depressed while turn ON the transceiver.
4. The LCD will display "PASS" to indicate entering into the CH mode successfully.



5. Turn OFF the power switch and then turn on the power. It will the CH mode display on LCD.

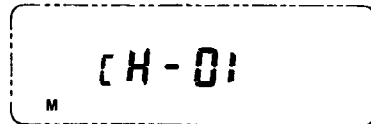

5-16-2 Normal frequency display mode

Performs the procedures 2,3,4,5 as indicated in 5-16-1 will return to the normal frequency display mode.

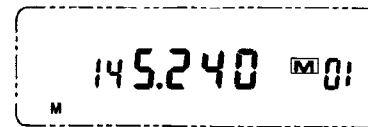

6 MAIN

6-1 GENERAL

Your transceiver accordance with only be read by the transceiver. When operating some general

6-2 SERVICE

If it ever becomes a full description related to the **Service not** Dear OM, if PLEASE make

Please list: M
T

Please give suggestions might be used
Caution:

Do not pack
Notes:

1. Record the
2. For your
3. When clear

6 MAINTENANCE

6-1 GENERAL INFORMATION

Your transceiver has been factory aligned and tested to specification before shipment. Under normal circumstances the transceiver will operate in accordance with these operating instructions. All adjustable trimmers and coils in your transceiver have been adjusted at the factory and should only be readjusted by a qualified technician with proper test equipment. Attempting service or alignment without factory authorization can void the transceiver's warranty.

When operated properly, the transceiver will provide many years of service without requiring realignment. The information in this section gives some general service procedures which can be accomplished without sophisticated test equipment.

6-2 SERVICE

If it ever become necessary to return the equipment to your dealer or service center for repair, pack it in its original box and packing, and include a full description of the problems involved. Please include your daytime telephone number. You need not return accessory items unless directly related to the service problem.

Service note:

Dear OM, if you desire to correspond on a technical or operational problem, please make your note short, complete, and to the point, and PLEASE make it readable.

Please list: Model and serial number.

The problem you are having.

Please give sufficient detail for diagnosis. Provide information such as other equipment in the station, meter readings and anything else you feel might be useful in attempting diagnosis.

Caution:

Do not pack the equipment in crushed newspapers for shipment. Extensive damage may result during shipment.

Notes:

1. Record the date of purchase, serial number and dealer from whom purchased.
2. For your own information, retain a written record of any maintenance performed on the unit.
3. When claiming warranty service, please include a photocopy of the bill of sale, or other proof of purchase showing the date of sale.

6-3 IN CASE OF DIFFICULTY

The problems described in this table are failures caused, in general, by improper operation or connection of the transceiver, not by defective components. Check according to the following table.

Symptom	Probable cause	Corrective action
Indicators do not light and no receiver noise is heard when the POWER switch is turned on.	1. Bad power cable or connections. 2. Blown power supply fuse.	1. Check cables and connections. 2. Check for the cause of the blown fuse and replace the fuse.
No sound from the speaker. No signal can be received.	1. Squelch is closed. 2. With the CTS146, CTCSS is operating.	1. Turn the SQ control counterclockwise. 2. Press the TONE/DUAL key to turn off the CTCSS.
No transmitter output.	1. Microphone is not plugged in. 2. Poor antenna connection.	1. Plug jack in. 2. Connect antenna securely.
Weak signal cannot be received.	Poor antenna connection.	Connect antenna securely.
Display is dark.	1. Power voltage is low. 2. The DIM had been selected too dark.	1. Check voltage for 13.8 VDC \pm 15%. 2. Press the F key and the LOW/DIM key.
The display will not change when the tuning controls rotated or a key is pressed.	The lock is on.	Press the MHz/LCOK key within ten seconds of pressing the F key.

Installin

CAUTION
Before ins
battery, or

CTCSS

The use
allows CT
active squ

Installat

1. Remov
Top co
2. Careful
..(Fig.1
3. Remov
cushio
and at
CTS 1.
4. Attach
shown
5. Remov
side (
- attach
sceiver
6. Replac
screws

Installing accessories

CAUTION

Before installation, be sure to disconnect the DC power supply, or battery, or damage may occur the equipment.

CTCSS unit CTS 146

The use of the optional sub-audible tone decoder CTS146 allows CTCSS (Tone squelch) operation. When this option is active squelch will only open when the proper tone is received.

Installation

1. Remove the 2 screws securing the Top cover.
2. Carefully remove the top cover..(Fig.1)
3. Remove the backing from the small cushion provided with the CTS146 and attach it to the back of the CTS 146 as shown in Fig.2.
4. Attach the cable from CTS146 as shown in Fig.2.
5. Remove the badking from the other side of the small cushion and attach the CTS146 to the transceiver as shown.
6. Replace the cover and tighten the screws to complete the installation.

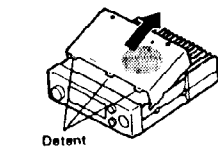

Fig. 1

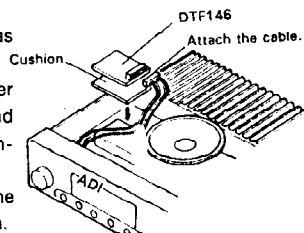

Fig. 2

DTMF unit DTF146

1. Remove the 2 screws securing the Top cover.
2. Carefully remove the top cover.(Fig.1)

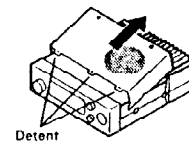
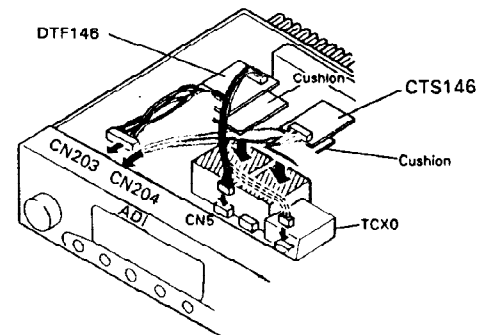

Fig. 1

3. Remove the backing from the small cushion provided with the DTF146 and attach it to the back of the DTF146.
4. Plug the three connectors into the sockets in the units.
5. Attach the cable from DTF146 as shown in Fig.2



6. Replace the cover and tighten the screws to complete the installation.



○ **Installing CTS146 and DTF146**

Attach these units on the top of VCO shield(Fig.2).



ONE YEAR LIMITED WARRANTY

- ADI Communications Corp. warrants this product against defects in material and workmanship.
- In the unlikely event of any failure due to defect in material or workmanship, occurring within one year of purchase, this product will be repaired or replaced at our discretion at no charge.
- The defective product should be returned in its original packing and with proof of the date of the original retail purchase to your dealer for warranty service.
- The warranty does not cover accident, misuse, fire, flood and other Act of God, unauthorized repair or altered serial numbers.
- Some statutory regulations do not allow for the exclusion or limitation of incidental or consequential damages, nor allow limitations on how long an implied warranty lasts, therefore the above limitations may not apply to you,

ADI  Communications and  are registered trademark of ADI Communications Corporation



NX157A059E
